



**THE DATASHEET OF
1863190000**



SC-SMT 3.81/07/90G 1.5SN BK RL

Weidmüller Interface GmbH & Co. KG

Klingenbergstraße 26

D-32758 Detmold

Germany

www.weidmueller.com

Product image

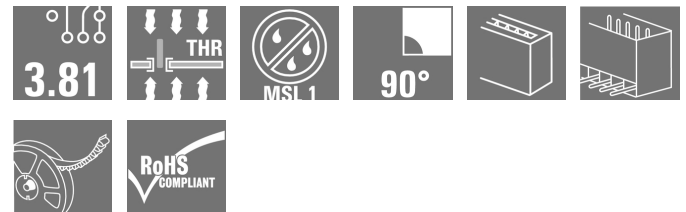

Similar to illustration

High-temperature-resistant pin header (SC-SMT 90G) in 3.81-mm pitch (0.15 inch)

- Plugging direction parallel to PCB (recumbent)
- Closed (G)
- Packed either in box (BX) or on anti-static roll (tape-on-reel, RL)
- Pin length of either 1.5 mm or 3.2 mm

Weidmüller's 3.81-mm-pitch (0.15 inch) plug-in connectors are compatible with the layouts of standard connectors and offer space for labelling and coding.

General ordering data

Version	PCB plug-in connector, male header, closed side, THT/THR solder connection, 3.81 mm, Number of poles: 7, 90°, Solder pin length (l): 1.5 mm, tinned, black, Tape
Order No.	1863190000
Type	SC-SMT 3.81/07/90G 1.5SN BK RL
GTIN (EAN)	4032248428380
Qty.	400 pc(s).
Product data	IEC: 320 V / 17.5 A UL: 300 V / 11 A
Packaging	Tape

Creation date September 16, 2022 7:42:04 PM CEST

SC-SMT 3.81/07/90G 1.5SN BK RL

Weidmüller Interface GmbH & Co. KG

Klingenbergstraße 26

D-32758 Detmold

Germany

www.weidmueller.com

Technical data

Dimensions and weights

Depth	9.2 mm	Depth (inches)	0.362 inch
Height	8.57 mm	Height (inches)	0.337 inch
Height of lowest version	7.07 mm	Width	27.36 mm
Width (inches)	1.077 inch	Net weight	2.675 g

System specifications

Product family	OMNIMATE Signal - series BC/SC 3.81	Type of connection	Board connection
Mounting onto the PCB	THT/THR solder connection	Pitch in mm (P)	3.81 mm
Pitch in inches (P)	0.15 inch	Outgoing elbow	90°
Number of poles	7	Number of solder pins per pole	1
Solder pin length (l)	1.5 mm	Solder pin length tolerance	0 / -0,02 mm
Solder pin dimensions	d = 1.0 mm, Octagonal	Solder pin dimensions = d tolerance	0 / -0,04 mm
Solder eyelet hole diameter (D)	1.3 mm	Solder eyelet hole diameter tolerance (D)	+ 0,1 mm
Outside diameter of solder pad	2.1 mm	Template aperture diameter	1.9 mm
L1 in mm	22.86 mm	L1 in inches	0.9 inch
Number of rows	1	Pin series quantity	1
Touch-safe protection acc. to DIN VDE 57 106	Safe from finger touch	Touch-safe protection acc. to DIN VDE 0470	IP 20
Volume resistance	≤5 mΩ	Can be coded	Yes

Material data

Insulating material	LCP GF	Colour	black
Colour chart (similar)	RAL 9011	Insulating material group	IIIa
Comparative Tracking Index (CTI)	≥ 175	Moisture Level (MSL)	1
UL 94 flammability rating	V-0	Contact material	Copper alloy
Contact surface	tinned	Storage temperature, min.	-40 °C
Storage temperature, max.	70 °C	Operating temperature, min.	-50 °C
Operating temperature, max.	120 °C	Temperature range, installation, min.	-25 °C
Temperature range, installation, max.	120 °C		

Rated data acc. to IEC

tested acc. to standard	IEC 60664-1, IEC 61984	Rated current, min. number of poles (Tu=20°C)	17.5 A
Rated current, max. number of poles (Tu=20°C)	13.9 A	Rated current, min. number of poles (Tu=40°C)	17 A
Rated current, max. number of poles (Tu=40°C)	12.4 A	Rated voltage for surge voltage class / pollution degree II/2	320 V
Rated voltage for surge voltage class / pollution degree III/2	160 V	Rated voltage for surge voltage class / pollution degree III/3	160 V
Rated impulse voltage for surge voltage class/ pollution degree II/2	2.5 kV	Rated impulse voltage for surge voltage class/ pollution degree III/2	2.5 kV
Rated impulse voltage for surge voltage class/ contamination degree III/3	2.5 kV	Short-time withstand current resistance	3 x 1s with 76 A

SC-SMT 3.81/07/90G 1.5SN BK RL

Weidmüller Interface GmbH & Co. KG

Klingenbergstraße 26

D-32758 Detmold

Germany

www.weidmueller.com

Technical data

Rated data acc. to CSA

Institute (CSA)



Certificate No. (CSA)

200039-1121690

Rated voltage (Use group B / CSA)

300 V

Rated current (Use group B / CSA)

11 A

Reference to approval values

Specifications are maximum values, details - see approval certificate.

Packing

Packaging	Tape	VPE length	330 mm
VPE width	330 mm	VPE height	64 mm
Tape depth (T2)	11.1 mm	Tape width (W)	44 mm
Tape pocket depth (K0)	10.6 mm	Tape pocket height (A0)	9.5 mm
Tape pocket width (B0)	33.2 mm	Tape pocket separation (P1)	16 mm
Tape hole separation (E)	1.75 mm	Tape pocket separation (F)	20.2 mm
Tape reel diameter \varnothing (A)	330 mm	Surface resistance	$R_s = 10^9 - 10^{12} \Omega$

Classifications

ETIM 6.0	EC002637	ETIM 7.0	EC002637
ETIM 8.0	EC002637	ECLASS 9.0	27-44-04-02
ECLASS 9.1	27-44-04-02	ECLASS 10.0	27-44-04-02
ECLASS 11.0	27-46-02-01	ECLASS 12.0	27-46-02-01

Important note

IPC conformity

Conformity: The products are developed, manufactured and delivered according international recognized standards and norms and comply with the assured properties in the data sheet resp. fulfill decorative properties in accordance with IPC-A-610 "Class 2". Further claims on the products can be evaluated on request.

Notes

- Rated current related to rated cross-section & min. No. of poles.
- Rated data refer only to the component itself. Clearance and creepage distances to other components are to be designed in accordance with the relevant application standards.
- P on drawing = pitch
- Long term storage of the product with average temperature of 50 °C and average humidity 70%, 36 months

Approvals

Approvals



ROHS

Conform

UL File Number Search

UL Website

Certificate No. (cURus)

E60693

SC-SMT 3.81/07/90G 1.5SN BK RL

Weidmüller Interface GmbH & Co. KG
Klingenbergstraße 26
D-32758 Detmold
Germany

www.weidmueller.com

Technical data

Downloads

Approval/Certificate/Document of Conformity	Declaration of the Manufacturer
Engineering Data	CAD data – STEP
Product Change Notification	PCN_2015_208_PL30X_SC-SMT_SL_SMT_3.xx_5.xx_new_Tape_Packaging_Step_1_EN PCN_2015_208_PL30X_SC-SMT_SL_SMT_3.xx_5.xx_neue_Tapeverpackung_Step_1_DE 20210831 SC-SMT 3.81.. 90° und 180° - Erweiterung der Fertigungsverfahren 20210831 SC-SMT 3.81.. 90° and 180° - Expansion of the production processes
Catalogues	Catalogues in PDF-format
Brochures	FL DRIVES EN MB SMT EN FL DRIVES DE MB DEVICE MANUF. EN FL BUILDING SAFETY EN FL APPL LED LIGHTING EN FL INDUSTR.CONTROLS EN FL MACHINE SAFETY EN FL HEATING ELECTR EN FL APPL INVERTER EN FL_BASE_STATION_EN FL ELEVATOR EN FL POWER SUPPLY EN FL 72H SAMPLE SER EN PO OMNIMATE EN PO OMNIMATE EN
White paper surface mount technology	Download Whitepaper

SC-SMT 3.81/07/90G 1.5SN BK RL

Weidmüller Interface GmbH & Co. KG
 Klingenbergstraße 26
 D-32758 Detmold
 Germany

www.weidmueller.com

Drawings

Dimensional drawing

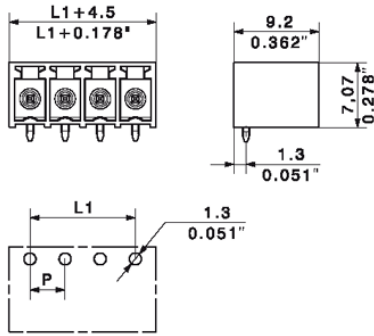

Example of use



Dimensional drawing

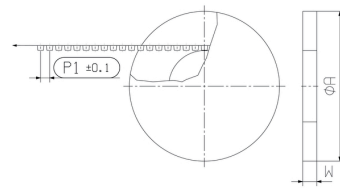

Dimensional drawing

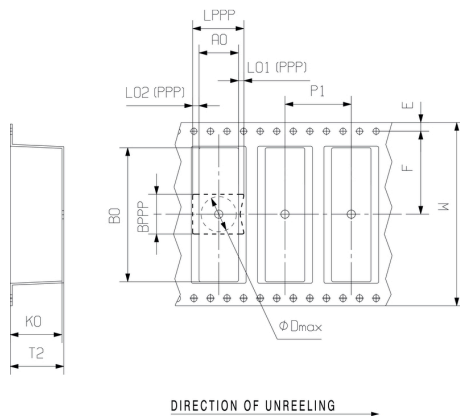

The reproduction, distribution and utilization of this document as well as the communication of its contents to others without explicit authorization is prohibited. Offenders will be held liable for the payment of damages. Weidmüller exclusively reserves the right to file for patents, utility models or designs.

© Weidmüller Interface GmbH & Co. KG

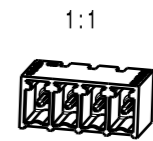
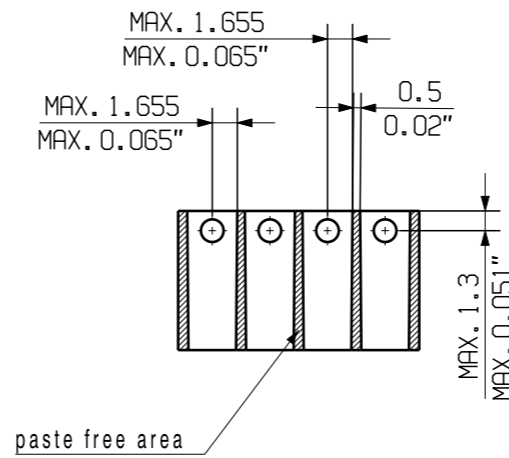
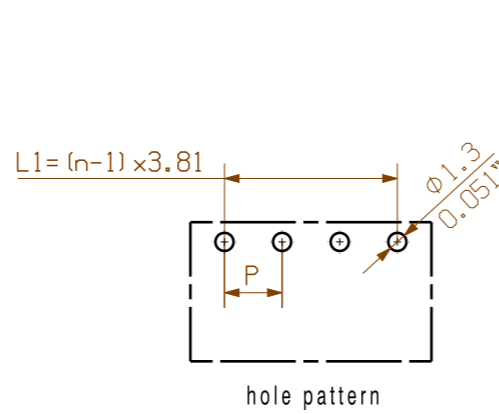
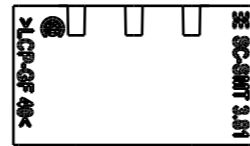
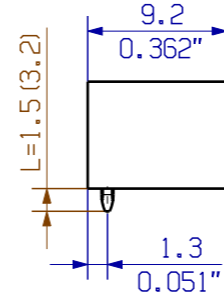
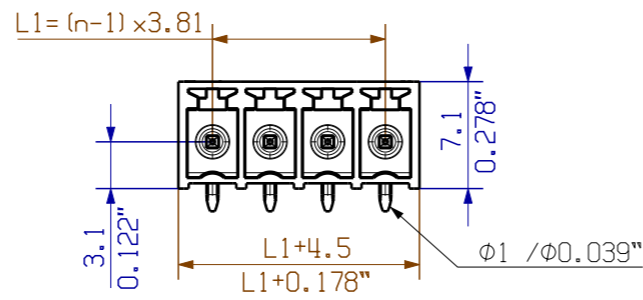

16	57,15	2,252
15	53,34	2,102
14	49,53	1,951
13	45,72	1,801
12	41,91	1,651
11	38,1	1,501
10	34,29	1,351
9	30,48	1,201
8	26,67	1,051
7	22,86	0,901
6	19,05	0,751
5	15,24	0,600
4	11,43	0,450
3	7,62	0,300
2	3,81	0,150
n	L1 [mm]	L1 [Inch]

pin length l	tolerance			
		1,5	0,0	6
3,2	-0,2	5	15,24	0,600
	0,0	4	11,43	0,450
2,1	-0,2	3	7,62	0,300
	0,1	2	3,81	0,150

P = Raster/pitch
n = Polzahl/no of poles
shown: SC-SMT3.81/04/90G

For the mounting of PCBs, it should be noted that the rated data relates only to the PCB components alone. The necessary creepage and clearance paths must be observed in connection with the respective applicant in accordance to IEC 664 / VDE 0110. The current-carrying capacity and pitch tolerance is to be determined according to DIN IEC 326 part 3 very fine.

Weidmüller PCB components are tested to the DIN EN 61984 standard, and are valid for its field of application. Provided that the components are used to the intended purpose, all requirements with respect to the occurring of electrical, mechanical, thermic and corrosive stress will be satisfied.

GENERAL TOLERANCE: DIN ISO 2768-m		106980/5 02.08.18 HELIS_MA 00	Cat.no.: .	
				3 36136 27
		Drawing no. Issue no. Sheet 02 of 05 sheets		
Scale: 5:1 SuperSedes: .		Date Name Drawn 11.11.2004 POCTA_C Responsible AMANN_A Checked 29.08.2018 HELIS_MA Approved LANG_T	SC-SMT 3.81/02...16/90... STIFTLISTE MALE HEADER	
		Product file: SC-SMT 3.81		7278

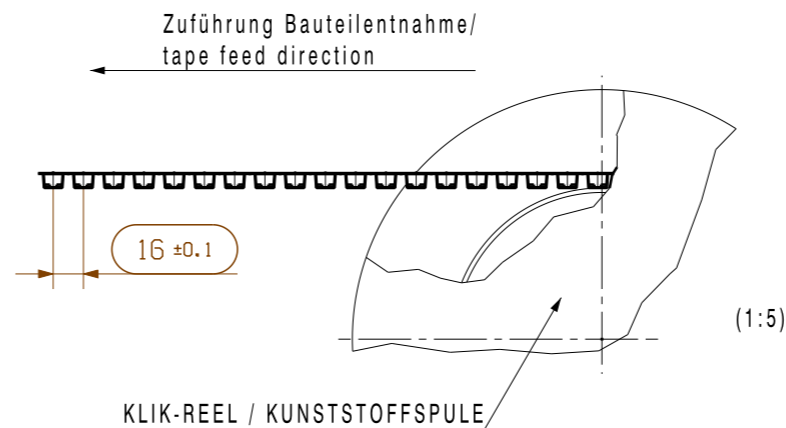
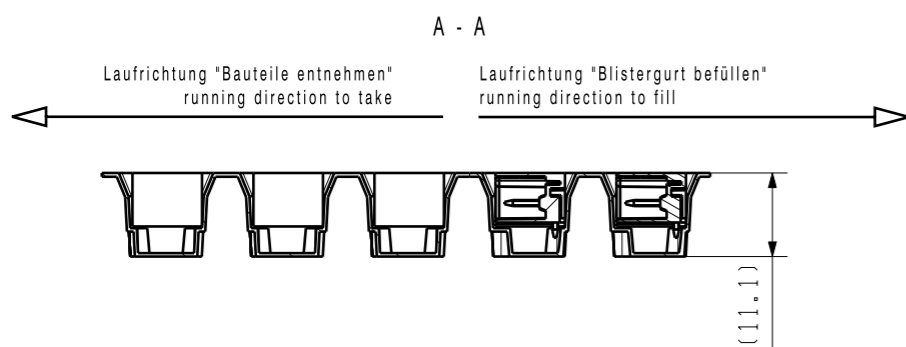

shown: SC-SMT 3.81/04/180G 1.5 ..

pick and place area max. Ø7

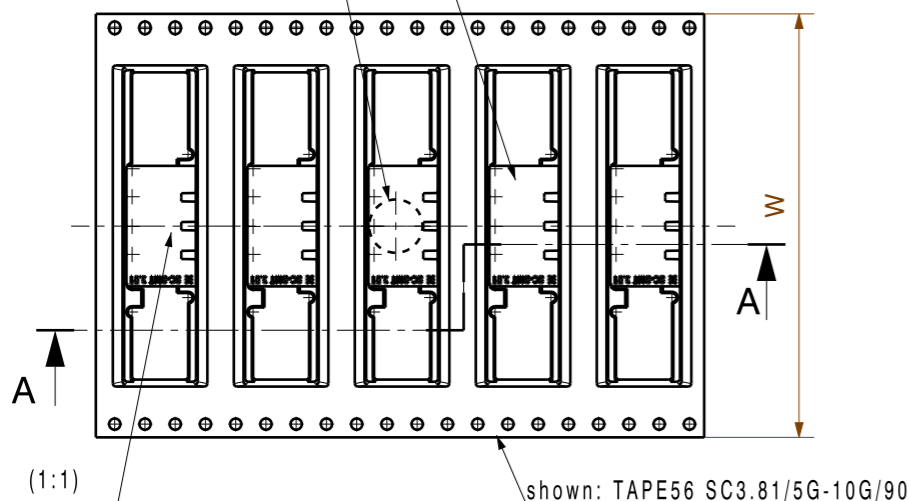

gerade Polzahl dargestellt/
even pole number shown

ungerade Polzahl Drehung Stiftleiste um 180°/
uneven pole number pin header rotated 180°

Stiftleisten müssen mittig im Tape sitzen /
pin header assembled in the middle

Information: F= Lötflanschvariante ohne Lötflanschstift mit Vierkannmutter / solder flange version without solder flange pin but with square nut

Tapebreite/ tape width (Mat.nr.)	no of poles	SC-SMT 3.81/././90.. 1.5SN BK		90.. 2.6SN BK	SC-SMT 3.81/././90.. 3.2SN BK		SC-SMT 3.81/././90.. 2.1SN BK		SC-SMT 3.81/././90.. 1.5SN OR		SC-SMT 3.81/././90.. 1.5AU BK	
		Bestellnr./cat.no.		Bestellnr./ cat.no.	Bestellnr./cat.no.		Bestellnr./cat.no.		Bestellnr./cat.no.		Bestellnr./cat.no.	
W	n	G	LF	F	G	LF	G	LF	G	LF	G	LF
32 (1437290000)	2	1863140000	1862720000	2780690000	1862810000	1863890000	2429820000		1105060000			
	3	1863150000	/	(29)	1862840000	/	2128630000	/		/		
	4	1863160000	/	/	1862860000	/	2495680000	/		/	2522690000	
44 (2017990000)	3	/	1862750000		/	1863970000	/		/			
	4	/	1862770000		/	1863980000	/		/			
	5	1863170000	1862790000	2780700000	1862870000							
	6	1863180000	1862820000	(29)	1862880000							
	7	1863190000	/	/		/		/		/		
	8	1863200000	/	/		1862900000	/		/			
56 (1348070000)	7	/	1862830000		/		/		/			
	8	/	1862850000		/		/		/			
	9	1863210000	/	/		/		/		/		
	10	1863220000	/	/		1862930000	/		/			
88 (1396710000)	9	/	1430360000		/	1430370000	/		/			
	10	/	1430380000		/	1430390000	/		/			
	11	1430230000	1430400000			1430420000						
	12	1430250000	1430430000		1430240000	1359450000						
	13	1430270000	1430440000		1430260000	1430450000						
	14	1430290000	1430470000		1430280000	1430480000						
	15	1430330000	1430490000		1430320000	1430500000						
	16	1430350000	1430510000		1430340000	1430520000						

Tape und Reel gemäß IEC 286-3 (EN 60286-3) /
tape and reel according to IEC 286-3 (EN 60286-3)

First Issue Date 11.11.2004		Max. nos.		Prim PLM Part No.: 024124		Prim ERP Part No.: 1862980000	
Modification		Date		Name		Weidmüller	
Scale: 1:1		Date		Name		36136 (29)	
Size: A3		Date		Name		Drawing no. Issue no.	
Drawings Assembly		Date		Name		Sheet 6 of 6 sheets	
Product file: 7278 SC-SMT 3.81		Date		Name		SC-SMT 3.81/02...16/90... STIFTLEISTE MALE HEADER	

Recommended wave soldering profiles

Weidmüller Interface GmbH & Co. KG
 Klängenbergstraße 16
 D-32758 Detmold
 Germany
 Fon: +49 5231 14-0
 Fax: +49 5231 14-292083
 www.weidmueller.com

Single Wave:



Double Wave:



Wave soldering profiles

Wired connection elements should be processed in accordance with the DIN EN 61760-1 standard. We have included two recommendations for practical wave soldering profiles, with which Weidmüller PCB terminals and connectors are qualified.

When choosing a suitable profile for your application, the following factors also need to be considered:

- PCB thickness
- Proportion of Cu in the layers
- Single/double-sided assembly
- Product range
- Heating and cooling rates

The single and double wave profiles each indicate the recommended operating range, including the maximum soldering temperature of 260°C. In practice, the maximum soldering temperature is quite often well below the above maximum profile.

Recommended reflow soldering profile

Weidmüller Interface GmbH & Co. KG
 Klingenbergstraße 16
 D-32758 Detmold
 Germany
 Fon: +49 5231 14-0
 Fax: +49 5231 14-292083
 www.weidmueller.com



Reflow soldering profile

The perfect soldering profile for SMT Surface Mount Technology is one the most exiting question in SMT production. But there are more than one correct answer: The diagram of temperature-on-time is related to processing features of solder paste and to maximum load of components.

We have to consider the following parameters:

- Time for pre heating
- Maximum temperature
- Time above melting point
- Time for cooling
- Maximum heating rate
- Maximum cooling rate

We recommend a typical solder profile with associated process limits. With preheating components and board are prepared smoothly for the solder phase. Heating rate is typically $\leq +3K/s$. In parallel the solder paste is ‚activated‘. The time above melting point of 217°C the paste gets liquid and components and boards begin to connect. The maximum temperature of 245°C to 254°C should stay between 10 and 40 seconds. In the cooling phase at $\geq -6K/s$ solder is cured. Board and components cool down while avoiding cold cracks.

Mouser Electronics

Authorized Distributor

Click to View Pricing, Inventory, Delivery & Lifecycle Information:

[Weidmuller:](#)

[1863190000](#)





Looking for pricing, stock, or lifecycle information?

Click below to explore more details on WIN SOURCE:

 [View 1863190000 on WIN SOURCE](#)

 [Weidmuller Information](#)

Optimize Your Supply Chain with WIN SOURCE Solutions

-  Global Sourcing Solution
-  Obsolete Management
-  Cost Control Management
-  Shortage Management
-  Alternative Solution
-  Excess Inventory Management