



THE DATASHEET OF
1834070000



As experienced experts we support our customers and partners around the world with products, solutions and services in the industrial environment of power, signal and data. We are at home in their industries and markets and know the technological challenges of tomorrow. We are therefore continuously developing innovative, sustainable and useful solutions for their individual needs. Together we set standards in Industrial Connectivity.

Modular Terminal Blocks Catalogue 2012/2013

Modular Terminal Blocks

Connectivity

Catalogue 2012/2013

Weidmüller 

Weidmüller Interface GmbH & Co. KG
Klingenbergstraße 16
32758 Detmold, Germany
T +49 5231 14-0
F +49 5231 14-292083
info@weidmueller.com
www.weidmueller.com



4 050118 072501

Order number: 1282250000/03/2012/SMDM



Weidmüller 

Product Portfolio

Weidmüller is a leading international provider of solutions for electrical connectivity, transmission and conditioning of power, signal and data in industrial environments. The company with headquarters in Detmold/Germany develops, produces and sells products in the field of electrical connectivity and electronics worldwide. www.power-signal-data.com

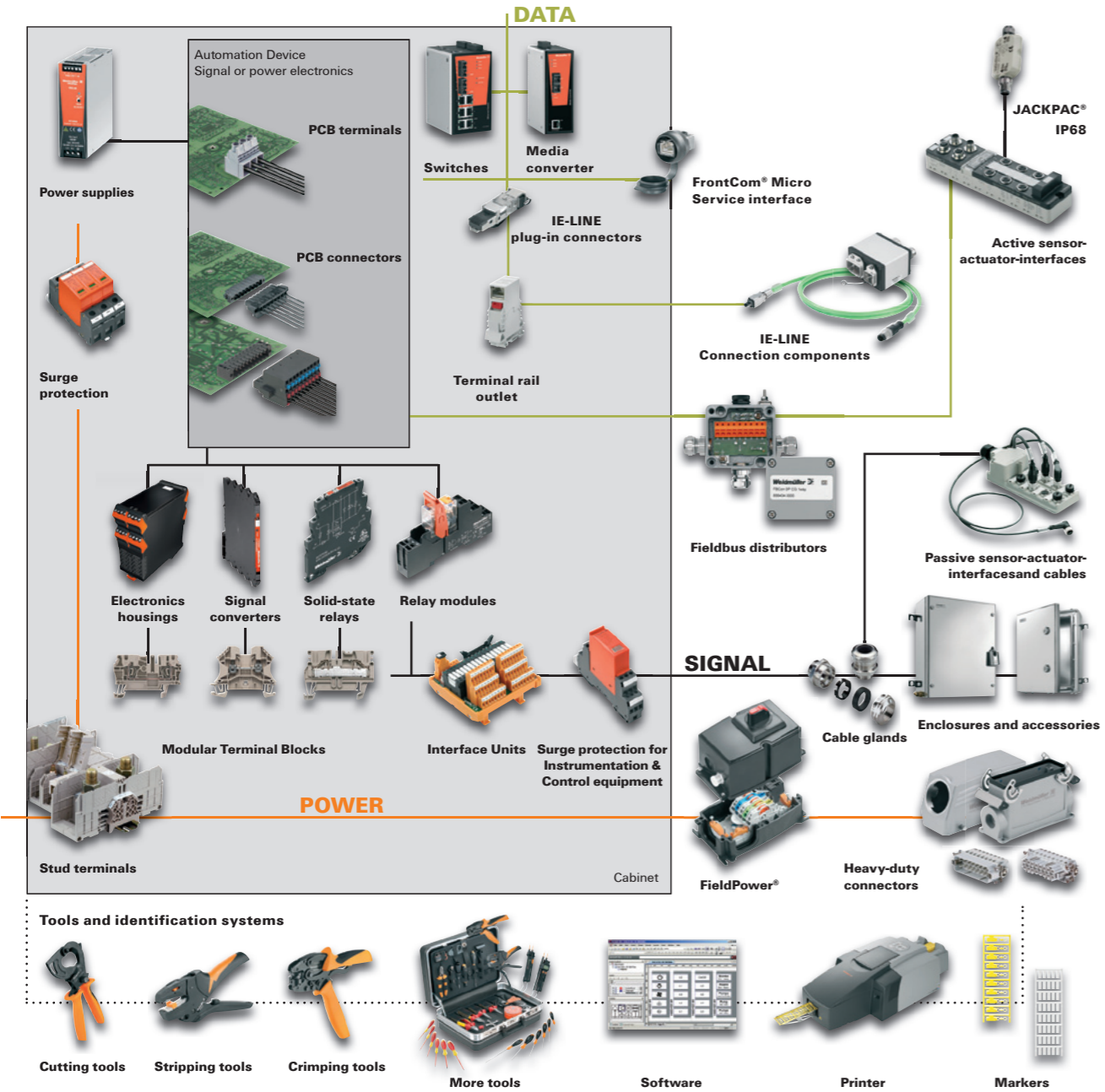

Modular Terminal Blocks

Catalogue 1

Modular Terminal Blocks

Overview

Terminals, P-Series (PUSH IN technology)

Terminals, Z-Series (Tension clamp technology)

Terminals, W-Series, Stud terminals, SAK-Series (Screw connection technology)

Shield connection terminals KLBÜ

Accessories

A

B

C

D

E

F

Appendix

Weidmüller Solutions & Service

Technical appendix

Index

Search according to Type or order number
Addresses worldwide

V

W

X

Modular Terminal Blocks

P-Series
Page B.4

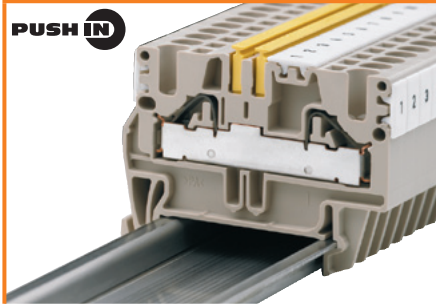

Z-Series
Page C.4

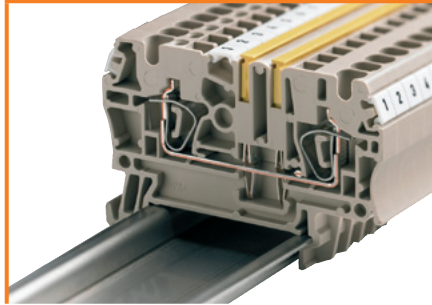

W-Series
Page D.4

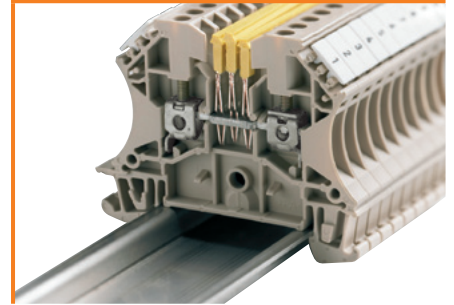

Modular terminals TS 15
Page D.130

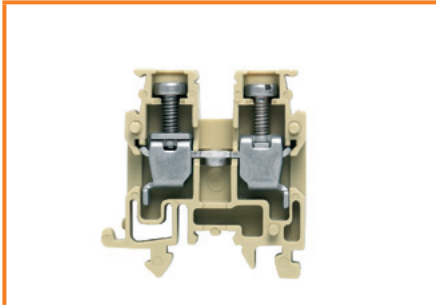

Multipin terminal strips
Page D.134

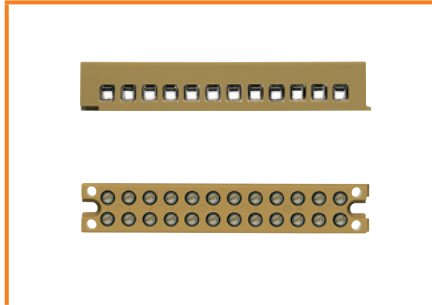

Stud terminals
Page D.144

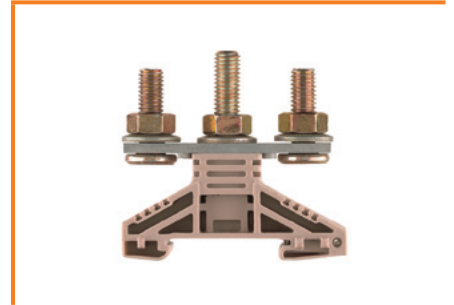

SAK-Series
Page D.184

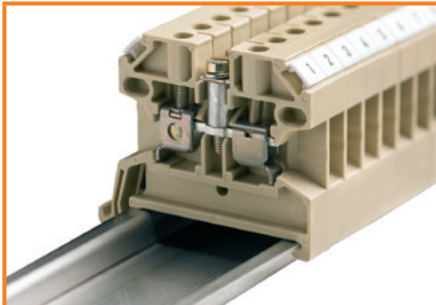

Shield connection terminals KLBÜ
Page E.6



Busbars/Terminal rails
Page F.2

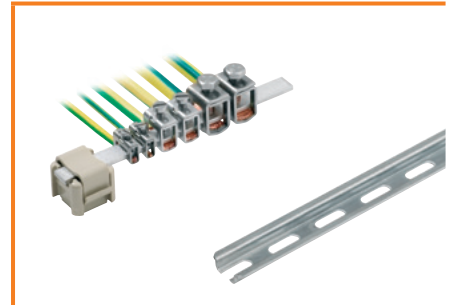

Connector markers
Page F.16

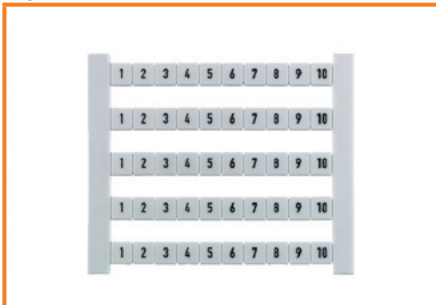

Tools
Page F.42



Wire end ferrules

Page F.66



Insulated cable connectors

Page F.78



Modular Terminal Blocks

Modular Terminal Blocks	Overview	A.2
--------------------------------	----------	-----

Always the optimum connection for your application



PUSH IN technology / P-Series

PUSH IN technology offers outstanding benefits. Firstly, it's easy to handle and is being widely used in building automation projects around the world. Secondly it provides galvanic isolation, giving excellent electrical rating and thirdly it provides pull-out, shock and vibration resistance.

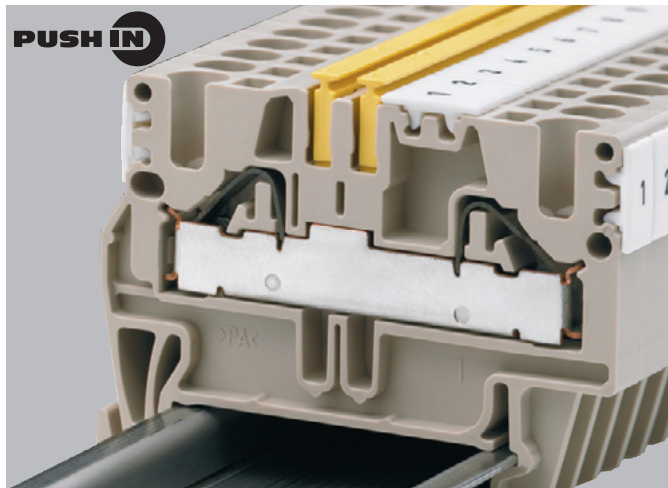

Time-saving connections

PUSH IN technology reduces installation times to a minimum.

Effective product range

Good performance data in a compact connection. The P-Series is ideal for reducing the number of variations.

100 % reliability

Simply push a stripped solid conductor or a conductor fitted with a wire end ferrule into the clamping point – and that's it, finished! All materials have been tested according to the latest environmental standards and to ensure RoHS conformity.

Applications

Wherever solid conductors or conductors fitted with wire end ferrules are needed, Weidmüller PUSH IN technology offers a decisive handling advantage. In machinery and building installations alike.



Tension clamp connection / Z-Series

For a maintenance free, vibration-resistant connection. The stainless steel tension clamp is the alternative to screw connection for cross-sections up to 35 mm².

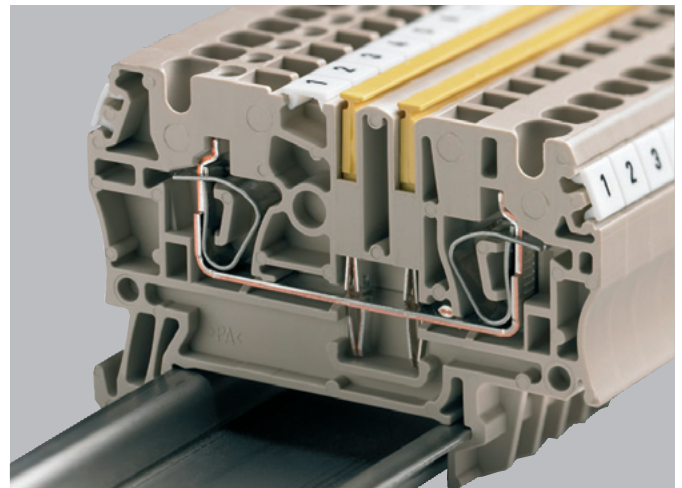

Comprehensive product range

Available in Standard and Roof-Style versions for connecting cross-sections from 0.05 to 35 mm².

Good contact stability – permanently

The no-maintenance, vibration-resistant tension clamp connection guarantees a gas-tight contact point and high contact forces.

Diverse cross-connection options

The ZQV plug-in standard cross-connection enables many different options. For feeding, distributing and skipping potentials.

Applications

Wherever an alternative to screw connection is required and where fast wiring times and vibration-resistant contacts are a must, the Weidmüller Z-Series is unbeatable. Whether in machinery, in the automotive industry, in railway engineering or shipbuilding.

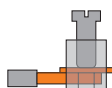

Screw connection / W-Series

The simple handling plus the separation of electrical and mechanical functions make the Weidmüller clamping yoke the universal standard solution.

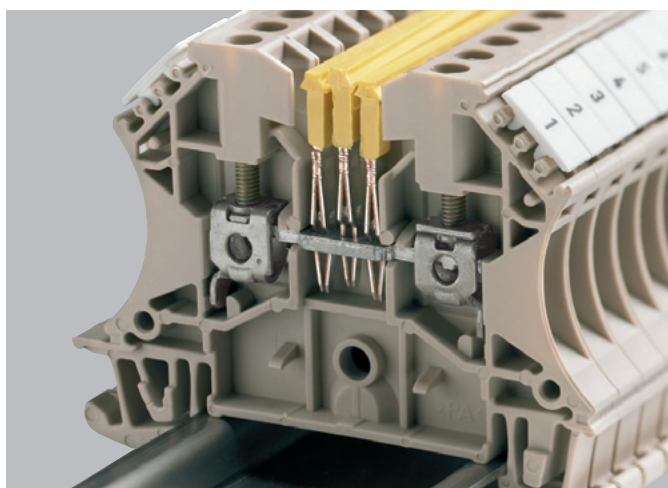

Wide range of cross-sections

The diverse, yet comprehensive range of products, covers cross-sections from 0.05 to 300 mm². That adds up to a complete product offering for safe or hazardous area applications.

Good contact stability – permanently

The maintenance free, vibration-resistant screw clamp guarantees a good contact force and a stable, secure connection.

Only the best materials

Hardened steel is used for strength in the clamping yoke, whilst tin plated copper ensures superior conductivity. All materials have been tested according to the latest environmental standards and to ensure RoHS compliance.

Applications

Wherever stable connections and secure contacts are essential, the Weidmüller W-Series is the right answer. In power generation and measurement, in process engineering and in switchgear installations.

Terminals, P-Series

Terminals, P-Series	Overview P-Series	B.2
	Feed-through terminals	B.4
	Double-level terminals	B.8
	Initiator and motor connection terminals	B.10
	PE terminals	B.11
	Fuse terminals	B.16
	Test-disconnect terminals	B.18
	Actuator and installation terminals - overview	B.24
	Actuator and installation terminals	B.26
	Marshalling- and potential distribution terminal blocks - overview	B.36
	Marshalling- and potential distribution terminal blocks	B.38
	Accessories P-Series	B.44

Terminal blocks with PUSH IN wire connection



Wiring is quick and safe

Increase your efficiency. The PUSH IN connection method and the associated reduction in the number of versions will help you.

Among the impressive features of the direct PUSH IN connection system are minimal wiring times and reliable, simple handling. Compared to the 3-conductor tension clamps, the direct PUSH IN system achieves time-savings of up to 50 % when connecting the conductor (3.5 seconds per conductor). The stripped solid conductor is simply pushed into the terminal as far as it will go – that's all there is to it. No tools are required, and the result is a reliable, vibration-resistant, gas-tight connection. Even flexible conductors with crimped wire end ferrules or ultrasonic-welded conductors can be connected without any problems.

Quick and safe

Wiring time is significantly reduced with the direct insertion technique for solid-core and flexible stranded wires with ferrules thanks to the PUSH IN connection method – considerably quicker to connect and no need for additional tools.

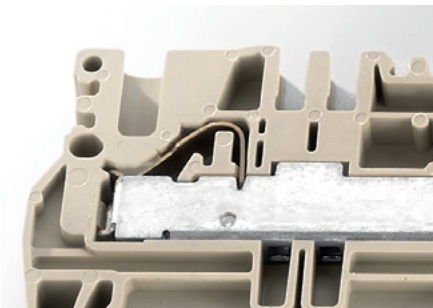
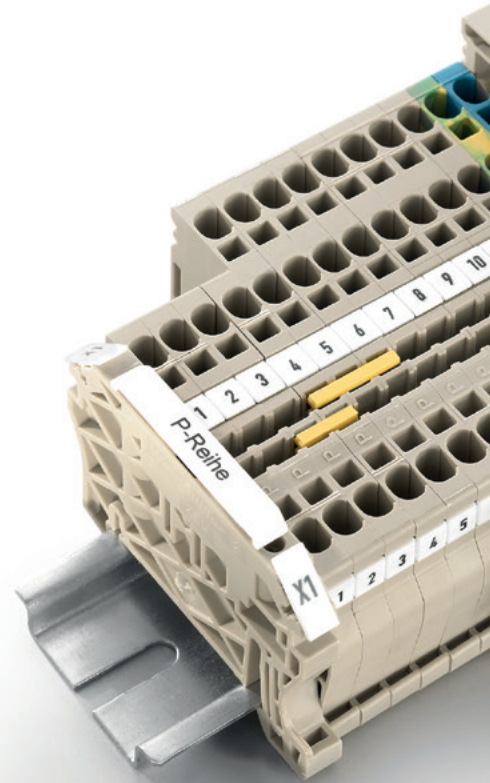

Contact security

The long-term contact force between wire and busbar is ensured with a stainless steel spring. The busbar is made of copper with a tin alloy, this ensures a very low voltage drop.



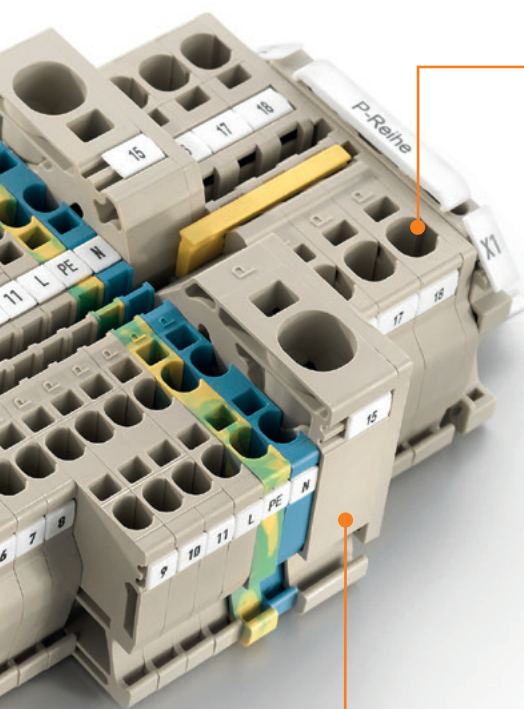

Simple operation

The PUSH IN contact's spring movement is limited by the spring stop mechanism, improper use is prevented by the design of the terminals.

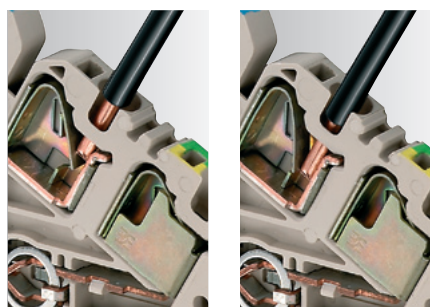

Wemid insulating material

- Non-tracking, CTI 600
- Thermally stable up to 120 °C
- V0 flammability rating to UL94
- Halogen and phosphor free, flame-retardant

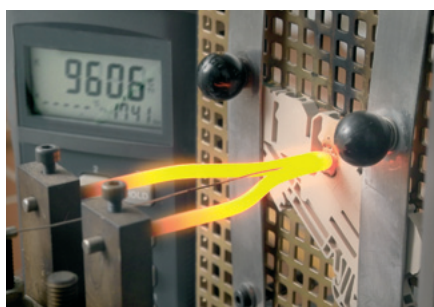

Feed-through terminals

B

In hazardous area applications, the installation instructions and the rated data specifications for accessories given in the technical appendix must be followed.

Width/Length/Height of lowest version	mm
max. current / max. cond. cross-section	A/mm ²
Max. clamping range	mm ²



Technical data

Rated data	
Rated voltage	V
Rated current	A
Rated cross-section	mm ²
Rated impulse withstand voltage / Pollution severity Gauge to IEC 60947-1 / Flammability class UL94	
Approvals	
Clamped conductors (H05V/H07V)	
Solid / stranded	mm ²
Flexible / Flexible with ferrule	mm ²
Twin wire-end ferrule	mm ²
Stripping length / Blade size	mm/-
Note	

Ordering data

Version	Dark beige Wemid Blue Wemid
Note	

Accessories

Pluggable cross-connection	
	2-pole 3-pole 4-pole 10-pole 20-/24-pole
End plate / Partition plate	
	Dark beige Wemid
End bracket	
	Dark beige Wemid
Test adapter	
	Standard With assembly peg
Screwdriver	
	Standard
Reducing sleeves	
	For conductors < 0.5 mm ² / AWG 20 For conductors < 1.0 mm ² / AWG 18
Cover	
	With lightning flash symbol
Identification systems	
	(see assortment in catalogue 7) Marking tags
Note	

PDU 2.5/4

4 mm²

2 connections



5.1 x 53 x 39	
/ 6	
0.13...6	

IEC 60947-7-1 Ex e II  II 2 G D

IEC	UL	CSA	EN 60079-7
800	600 (C)	600 (C)	550
32	30 (C)	30 (C)	29
4	AWG 26...10	AWG 26...10	4
8 kV / 3			
A3 / V-0			
			
Rated connection			
0.5...6			
0.5...4 / 0.5...4			
0.5...2.5			
12 / 3.0 x 0.5 mm			
Note			

Type	Qty.	Order No.
PDU 2.5/4	100	1896110000
PDU 2.5/4 BL	50	1896230000
For 4 mm ² conductors, use ferrules with a cross-section-optimised plastic collar (Order no. 9203630000).		

Type	current	Qty.	Order No.
ZQV 2.5/2	24 A	60	1608860000
ZQV 2.5/3	24 A	60	1608870000
ZQV 2.5/4	24 A	60	1608880000
ZQV 2.5/10	24 A	20	1608940000
ZQV 2.5/20	24 A	20	1908960000
Width			
PAP 2.5/4	2.5 mm	50	1896300000
ZEW 35	6 mm	20	9540000000
PTA PDU2.5/4	5.1 mm	25	1916180000
PTA ZA PDU2.5/4	5.1 mm	25	1916190000
SDS 0.5X3.0X80		1	9008320000
PRH 2.5/4/1	6.16 mm	100	1916410000
PRH 2.5/4/2	6.16 mm	100	1916400000
PAD 2.5/4/4	5.1 mm	80	1916150000
Note			

DEK 5/5 / WS 10/5
Detailed information for working with twin ferrules can be found in the P Series Accessories section.

PDU 2.5/4 3AN

4 mm²

3 connections

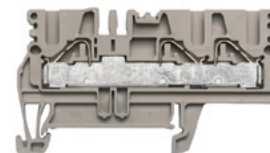

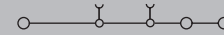
5.1 x 67.5 x 39	
/ 6	
0.13...6	

IEC 60947-7-1 Ex e II  II 2 G D

IEC	UL	CSA	EN 60079-7
800	600 (C)	600 (C)	550
32	30 (C)	30 (C)	29
4	AWG 26...10	AWG 26...10	4
8 kV / 3			
A3 / V-0			
			
Rated connection			
0.5...6			
0.5...4 / 0.5...4			
0.5...2.5			
12 / 3.0 x 0.5 mm			
Note			

Type	Qty.	Order No.
PDU 2.5/4/3AN	100	1896120000
PDU 2.5/4/3AN BL	50	1896240000
For 4 mm ² conductors, use ferrules with a cross-section-optimised plastic collar (Order no. 9203630000).		

Type	current	Qty.	Order No.
ZQV 2.5/2	24 A	60	1608860000
ZQV 2.5/3	24 A	60	1608870000
ZQV 2.5/4	24 A	60	1608880000
ZQV 2.5/10	24 A	20	1608940000
ZQV 2.5/20	24 A	20	1908960000
Width			
PAP 2.5/4/4AN	2.5 mm	50	1896320000
ZEW 35	6 mm	20	9540000000
PTA PDU2.5/4	5.1 mm	25	1916180000
PTA ZA PDU2.5/4	5.1 mm	25	1916190000
SDS 0.5X3.0X80		1	9008320000
PRH 2.5/4/1	6.16 mm	100	1916410000
PRH 2.5/4/2	6.16 mm	100	1916400000
PAD 2.5/4/4	5.1 mm	80	1916150000
Note			

DEK 5/5 / WS 10/5
Detailed information for working with twin ferrules can be found in the P Series Accessories section.

PDU 2.5/4 4AN

4 mm²

4 connections

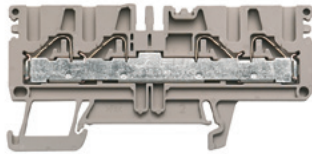

5.1 x 78.5 x 39
/ 6
0.13...6



IEC 60947-7-1

Ex e II II 2 G D

IEC	UL	CSA	EN 60079-7
800	600 (C)	600 (C)	550
32	30 (C)	30 (C)	27
4	AWG 26...10	AWG 26...10	4
8 kV / 3			
A3 / V-0			



Rated connection

0.5...6
0.5...4 / 0.5...4
0.5...2.5
12 / 3.0 x 0.5 mm

Type	Qty.	Order No.
PDU 2.5/4/4AN	100	1896130000
PDU 2.5/4/4AN BL	50	1896250000

For 4 mm² conductors, use ferrules with a cross-section-optimised plastic collar (Order no. 9203630000).

Type	current	Qty.	Order No.
ZQV 2.5/2	24 A	60	1608860000
ZQV 2.5/3	24 A	60	1608870000
ZQV 2.5/4	24 A	60	1608880000
ZQV 2.5/10	24 A	20	1608940000
ZQV 2.5/20	24 A	20	1908960000
Width			
PAP 2.5/4/4AN	2.5 mm	50	1896320000
ZEW 35	6 mm	20	9540000000
PTA PDU2.5/4	5.1 mm	25	1916180000
PTA ZA PDU2.5/4	5.1 mm	25	1916190000
SDS 0.5X3.0X80		1	9008320000
PRH 2.5/4/1	6.16 mm	100	1916410000
PRH 2.5/4/2	6.16 mm	100	1916400000
PAD 2.5/4/4	5.1 mm	80	1916150000

DEK 5/5 / WS 10/5

Detailed information for working with twin ferrules can be found in the P Series Accessories section.

PDU 2.5/4 2x2

4 mm²

2 x 2 connections

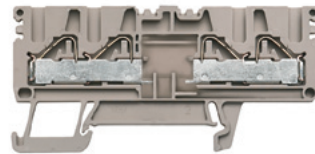

5.1 x 78 x 39
/ 6
0.13...6

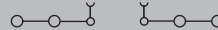

IEC 60947-7-1

IEC	UL	CSA
800		
32		
4		
8 kV / 3		
A3 / V-0		



Rated connection

0.5...6
0.5...4 / 0.5...4
0.5...2.5
12 / 3.0 x 0.5 mm

Type	Qty.	Order No.
PDU 2.5/4/2X2AN	50	1022220000

For 4 mm² conductors, use ferrules with a cross-section-optimised plastic collar (Order no. 9203630000).

Type	current	Qty.	Order No.
PAP 2.5/4/4AN	2.5 mm	50	1896320000
ZEW 35	6 mm	20	9540000000
PTA PDU2.5/4	5.1 mm	25	1916180000
PTA ZA PDU2.5/4	5.1 mm	25	1916190000
SDS 0.5X3.0X80		1	9008320000
PRH 2.5/4/1	6.16 mm	100	1916410000
PRH 2.5/4/2	6.16 mm	100	1916400000
PAD 2.5/4/4	5.1 mm	80	1916150000

DEK 5/5 / WS 10/5

Detailed information for working with twin ferrules can be found in the P Series Accessories section.

PDU 6/10

10 mm²

2 connections

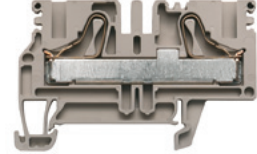

8.1 x 64.5 x 41.5
57 / 10
1.5...10



IEC 60947-7-1

IEC	UL	CSA	EN 60079-7
800	600 (C)	600 (C)	550
57	44 (C)	46 (C)	37
10	AWG 14...8	AWG 14...8	10
8 kV / 3			
A4 / V-0			



Rated connection

1.5...6
1.5...10 / 1.5...10
14 / 0.6 x 3.5 mm

Type	Qty.	Order No.
PDU 6/10	50	1896140000
PDU 6/10 BL	25	1896270000

For 10 mm² conductors, use ferrules with a cross-section-optimised plastic collar (Order no. 9203620000).

Type	current	Qty.	Order No.
ZQV 6N/2		60	1906210000
ZQV 6N/3		60	1906220000
ZQV 6N/4		60	1906230000
ZQV 6N/20		20	1906240000
Width			
PAP PDU6/10	2.5 mm	20	1896330000
ZEW 35	6 mm	20	9540000000
SDS 0.5X3.0X80		1	9008320000
PAD 6/10/4	5.3 mm	80	1916160000

WS 10/8

Feed-through terminals

B

In hazardous area applications, the installation instructions and the rated data specifications for accessories given in the technical appendix must be followed.

Width/Length/Height of lowest version	mm
max. current / max. cond. cross-section	A/mm ²
Max. clamping range	mm ²

Technical data

Rated data	
Rated voltage	V
Rated current	A
Rated cross-section	mm ²
Rated impulse withstand voltage / Pollution severity	
Gauge to IEC 60947-1 / Flammability class UL94	
Approvals	
Clamped conductors (H05V/H07V)	
Solid / stranded	mm ²
Flexible / Flexible with ferrule	mm ²
Twin wire-end ferrule	mm ²
Stripping length / Blade size	mm/-
Note	

Ordering data

Version	
	Dark beige Wemid
	Blue Wemid
Note	

Accessories

Pluggable cross-connection	
	2-pole
	3-pole
	4-pole
	10-pole
	20-/24-pole
End plate / Partition plate	
	Dark beige Wemid
End bracket	
	Dark beige Wemid
Test adapter	
	Standard
	With assembly peg
Screwdriver	
	Standard
Reducing sleeves	
	For conductors < 0.5 mm ² / AWG 20
	For conductors < 1.0 mm ² / AWG 18
Cover	
	With lightning flash symbol
Identification systems	
	(see assortment in catalogue 7)
	Marking tags
Note	

PDU 6/10 3AN

10 mm²

3 connections

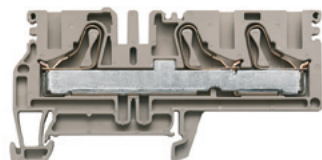

8.1 x 82.5 x 41.5
57 / 10
1.5...10

IEC 60947-7-1 Ex e II II 2 G D

IEC	UL	CSA	EN 60079-7
800	600 (C)	600 (C)	550
57	44 (C)	46 (C)	37
10	AWG 14...8	AWG 14...8	10
8 kV / 3			
A4 / V-0			
Rated connection			
1.5...6			
1.5...10 / 1.5...10			
14 / 0.6 x 3.5 mm			

Type	Qty.	Order No.
PDU 6/10/3AN	50	1896150000
PDU 6/10/3AN BL	50	1896280000

For 10 mm² conductors, use ferrules with a cross-section-optimised plastic collar (Order no. 9203620000).

Type	current	Qty.	Order No.
ZQV 6N/2		60	1906210000
ZQV 6N/3		60	1906220000
ZQV 6N/4		60	1906230000
ZQV 6N/20		20	1906240000
Width			
PAP PDU6/10/3AN	2.5 mm	20	1896340000
ZEW 35	6 mm	20	9540000000
SDS 0.5X3.0X80		1	9008320000
PAD 6/10/4	5.3 mm	80	1916160000

WS 10/8

PDU 6/10 4AN

10 mm²

NEW

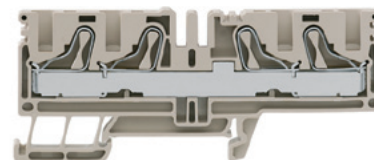

8.1 x 97 x 41.5
57 / 10
1.5...10

IEC 60947-7-1

IEC	UL	CSA
800	600 (C)	
57	47 (C)	
10	AWG 14...8	
8 kV / 3		
A4 / V-0		
Rated connection		
1.5...6		
1.5...10 / 1.5...10		
14 / 0.6 x 3.5 mm		

Type	Qty.	Order No.
PDU 6/10/4AN	50	1083040000
PDU 6/10 4AN BL	25	1165130000

Type	current	Qty.	Order No.
ZQV 6N/2		60	1906210000
ZQV 6N/3		60	1906220000
ZQV 6N/4		60	1906230000
ZQV 6N/20		20	1906240000
Width			
ZEW 35	6 mm	20	9540000000
SDS 0.5X3.0X80		1	9008320000
PAD 6/10/4	5.3 mm	80	1916160000

WS 10/8

PDU 16

16 mm²

2 connections

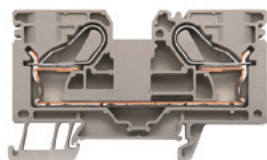

12.1 x 80.5 x 48
/ 16
2.5...16

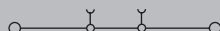

Ex e II II 2 G D

IEC	UL	CSA	EN 60079-7
800	600 (C)	600 (C)	550
76	75 (C)	78 (C)	59
16	AWG 14...4	AWG 14...4	16
8 kV / 3			
B6 / V-0			

Rated connection			
2.5...16			
2.5...16 / 2.5...16			

18 / 1.0 x 5.5 mm

Type	Qty.	Order No.
PDU 16	25	1896400000
PDU 16 BL	10	1896220000

Type	current	Qty.	Order No.
ZQV 16/2	76 A	25	1739690000
Width			
PAP 16	2.7 mm	10	1896290000
ZEW 35	6 mm	20	9540000000
Width			
SDIS SL 1.0X4.5X125		1	1274680000
Width			
PAD 16/4	7.3 mm	80	1916170000

WS 12/8

PEI 16

16 mm²

Supply terminal

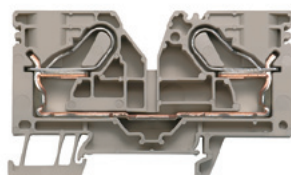

15 x 80.5 x 48
/ 16
2.5...16

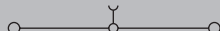

Ex e II II 2 G D

IEC	UL	CSA	EN 60079-7
800	600 (C)	600 (C)	550
76	75 (C)	78 (C)	66
16	AWG 14...4	AWG 14...4	16
8 kV / 3			
B6 / V-0			

Rated connection			
2.5...16			
2.5...16 / 2.5...16			

18 / 1.0 x 5.5 mm

Type	Qty.	Order No.
PEI 16	25	1918780000
PEI 16 BL	25	1918790000

Terminal contains end plate.
No separate end plate is necessary.

Type	current	Qty.	Order No.
ZQV 2.5/2	24 A	60	1608860000
ZQV 6N/3		60	1906220000
Width			
ZEW 35	6 mm	20	9540000000
Width			
SDIS SL 1.0X4.5X125		1	1274680000
Width			
PAD 16/4	7.3 mm	80	1916170000

WS 12/8

Double-level terminals

B

In hazardous area applications, the installation instructions and the rated data specifications for accessories given in the technical appendix must be followed.

Width/Length/Height of lowest version	mm
max. current / max. cond. cross-section	A/mm ²
Max. clamping range	mm ²



Technical data

Rated data	
Rated voltage	V
Rated current	A
Rated cross-section	mm ²
Rated impulse withstand voltage / Pollution severity Gauge to IEC 60947-1 / Flammability class UL94	
Approvals	
Clamped conductors (H05V/H07V)	
Solid / stranded	mm ²
Flexible / Flexible with ferrule	mm ²
Twin wire-end ferrule	mm ²
Stripping length / Blade size	mm/-
Note	

Ordering data

Version	Dark beige Wemid Blue Wemid
Note	

Accessories

Pluggable cross-connection	
	2-pole 3-pole 4-pole 10-pole 20-/24-pole
End plate / Partition plate	
	Dark beige Wemid
End bracket	
	Dark beige Wemid
Screwdriver	
	Standard
Reducing sleeves	
	For conductors < 0.5 mm ² / AWG 20 For conductors < 1.0 mm ² / AWG 18
Cover	
	With lightning flash symbol

Identification systems	(see assortment in catalogue 7) Marking tags
Note	

PDK 2.5/4

2.5 mm²

Double-level terminal

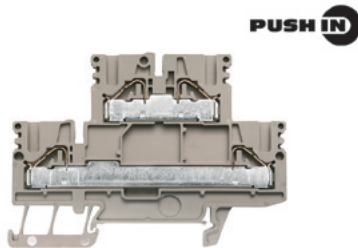

5.1 x 82.5 x 58.5
28 / 6
0.13...6

IEC 60947-7-1

IEC	UL	CSA
800	600 (C)	600 (C)
24	30 (C)	30 (C)
2.5	AWG 26...10	AWG 26...10
8 kV / 3		
A3 / V-0		
		
Rated connection		
0.5...6		
0.5...4 / 0.5...4		
0.5...2.5		
12 / 3.0 x 0.5 mm		
Note		

Type	Qty.	Order No.
PDK 2.5/4	50	1918770000
PDK 2.5/4 BL	50	1918760000
For 4 mm ² conductors, use ferrules with a cross-section-optimised plastic collar (Order no. 9203630000).		

Type	current	Qty.	Order No.
ZQV 2.5/2	24 A	60	1608860000
ZQV 2.5/3	24 A	60	1608870000
ZQV 2.5/4	24 A	60	1608880000
ZQV 2.5/10	24 A	20	1608940000
ZQV 2.5/20	24 A	20	1908960000
Width			
PAP PDK 2.5/4	2.5 mm	20	1919720000
ZEW 35	6 mm	20	9540000000
SDS 0.5X3.0X80		1	9008320000
PRH 2.5/4/1	6.16 mm	100	1916410000
PRH 2.5/4/2	6.16 mm	100	1916400000
PAD 2.5/4/4	5.1 mm	80	1916150000

Identification systems	(see assortment in catalogue 7) Marking tags
Note	DEK 5/5 / SNAPMARK I(1805880000) Detailed information for working with twin ferrules can be found in the P Series Accessories section.

PDK 2.5/4 V

2.5 mm²

Vertical cross-connected double-level terminal

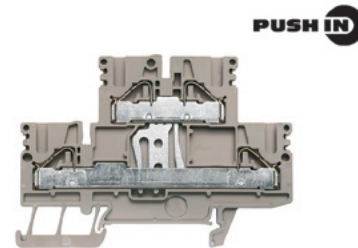

5.1 x 82.5 x 58.5
28 / 6
0.13...6

IEC 60947-7-1

IEC	UL	CSA
800	600 (C)	600 (C)
24	30 (C)	30 (C)
2.5	AWG 26...10	AWG 26...10
8 kV / 3		
A3 / V-0		
		
Rated connection		
0.5...6		
0.5...4 / 0.5...4		
0.5...2.5		
12 / 3.0 x 0.5 mm		
Note		

Type	Qty.	Order No.
PDK 2.5/4V	50	1918730000
PDK 2.5/4V BL	50	1918680000
For 4 mm ² conductors, use ferrules with a cross-section-optimised plastic collar (Order no. 9203630000).		

Type	current	Qty.	Order No.
ZQV 2.5/2	24 A	60	1608860000
ZQV 2.5/3	24 A	60	1608870000
ZQV 2.5/4	24 A	60	1608880000
ZQV 2.5/10	24 A	20	1608940000
ZQV 2.5/20	24 A	20	1908960000
Width			
PAP PDK 2.5/4	2.5 mm	20	1919720000
ZEW 35	6 mm	20	9540000000
SDS 0.5X3.0X80		1	9008320000
PRH 2.5/4/1	6.16 mm	100	1916410000
PRH 2.5/4/2	6.16 mm	100	1916400000
PAD 2.5/4/4	5.1 mm	80	1916150000

Identification systems	(see assortment in catalogue 7) Marking tags
Note	DEK 5/5 / SNAPMARK I(1805880000) Detailed information for working with twin ferrules can be found in the P Series Accessories section.

PDK 2.5/4 N-L

2.5 mm²

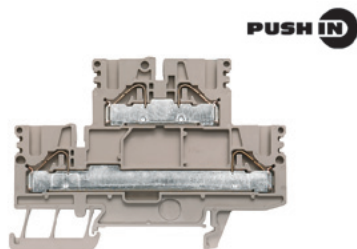

5.1 x 82.5 x 58.5
28 / 6
0.13...6

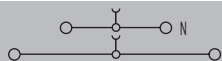

IEC 60947-7-1

IEC	UL	CSA
800	600 (C)	600 (C)
24	30 (C)	30 (C)
2.5	AWG 26...10	AWG 26...10
8 kV / 3		
A3 / V-0		

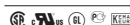

Rated connection

0.5...6
 0.5...4 / 0.5...4
 0.5...2.5
 12 / 3.0 x 0.5 mm

PDK 2.5/4 L-PE

2.5 mm²

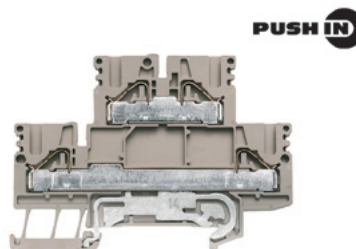

5.1 x 82.5 x 58.5
28 / 6
0.13...6

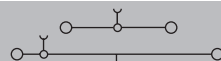

IEC 60947-7-2

IEC	UL	CSA
800	600 (C)	600 (C)
24	30 (C)	30 (C)
2.5	AWG 26...10	AWG 26...10
8 kV / 3		
A3 / V-0		

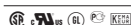

Rated connection

0.5...6
 0.5...4 / 0.5...4
 0.5...2.5
 12 / 3.0 x 0.5 mm

Type	Qty.	Order No.
PDK 2.5/4N-L	50	1918740000

For 4 mm² conductors, use ferrules with a cross-section-optimised plastic collar (Order no. 9203630000).

Type	Qty.	Order No.
PDK 2.5/4L-PE	50	1918720000

For 4 mm² conductors, use ferrules with a cross-section-optimised plastic collar (Order no. 9203630000).

Type	current	Qty.	Order No.
ZQV 2.5/2	24 A	60	1608860000
ZQV 2.5/3	24 A	60	1608870000
ZQV 2.5/4	24 A	60	1608880000
ZQV 2.5/10	24 A	20	1608940000
ZQV 2.5/20	24 A	20	1908960000
Width			
PAP PDK 2.5/4	2.5 mm	20	1919720000
ZEW 35	6 mm	20	9540000000
SDS 0.5X3.0X80		1	9008320000
PRH 2.5/4/1	6.16 mm	100	1916410000
PRH 2.5/4/2	6.16 mm	100	1916400000
PAD 2.5/4/4	5.1 mm	80	1916150000

Type	current	Qty.	Order No.
ZQV 2.5/2	24 A	60	1608860000
ZQV 2.5/3	24 A	60	1608870000
ZQV 2.5/4	24 A	60	1608880000
ZQV 2.5/10	24 A	20	1608940000
ZQV 2.5/20	24 A	20	1908960000
Width			
PAP PDK 2.5/4	2.5 mm	20	1919720000
ZEW 35	6 mm	20	9540000000
SDS 0.5X3.0X80		1	9008320000
PRH 2.5/4/1	6.16 mm	100	1916410000
PRH 2.5/4/2	6.16 mm	100	1916400000
PAD 2.5/4/4	5.1 mm	80	1916150000

DEK 5/5 / SNAPMARK I(1805880000)

Detailed information for working with twin ferrules can be found in the P Series Accessories section.

DEK 5/5 / SNAPMARK I(1805880000)

Detailed information for working with twin ferrules can be found in the P Series Accessories section.

Initiator and motor connection terminals

B

In hazardous area applications, the installation instructions and the rated data specifications for accessories given in the technical appendix must be followed.

Width/Length/Height of lowest version	mm
max. current / max. cond. cross-section	A/mm ²
Max. clamping range	mm ²

Technical data

Rated data	
Rated voltage	V
Rated current	A
Rated cross-section	mm ²
Rated impulse withstand voltage / Pollution severity Gauge to IEC 60947-1 / Flammability class UL94	
Approvals	
Clamped conductors (H05V/H07V)	
Solid / stranded	mm ²
Flexible / Flexible with ferrule	mm ²
Twin wire-end ferrule	mm ²
Stripping length / Blade size	mm/-
Note	

Ordering data

Version	
	Dark beige Wemid
Note	

Accessories

Pluggable cross-connection	
	2-pole
	3-pole
	4-pole
	10-pole
End plate / Partition plate	
	Dark beige Wemid
End bracket	
	Dark beige Wemid
Screwdriver	
	Standard

Identification systems	
	(see assortment in catalogue 7) Marking tags
Note	

PMAK 4

4 mm²

NEW



PUSH IN

5.1 x 103.86 x 79.05
/ 6
0.5...6

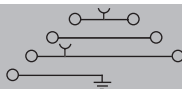

IEC 60947-7-1 (-7-2)

IEC	UL	CSA
400	300 (C)	
30	29 (C)	
4	AWG 26...10	
6 kV /		
A3 / V-0		
Rated connection		
0.5...6		
0.5...4 / 4...0.5		
12 / 0.4 x 2.5 mm		

Type	Qty.	Order No.
PMAK 4	50	1221340000

Type	current	Qty.	Order No.
ZQV 2.5/2	24 A	60	1608860000
ZQV 2.5/3	24 A	60	1608870000
ZQV 2.5/4	24 A	60	1608880000
ZQV 2.5/10	24 A	20	16088940000
Width			
PAP PMAK 4	1 mm	20	1221360000
Width			
ZEW 35/2	8 mm	20	8630740000
SDS 0.4X2.5X75		1	9009030000

Identification systems	
	DEK 5/5
Note	

PMAK 4 800 V

4 mm²

NEW

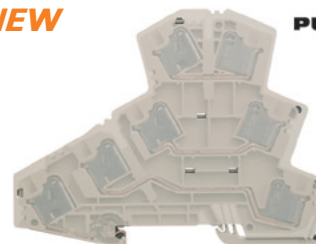

PUSH IN

6.1 x 107.5 x 82.6
/ 6
0.5...6

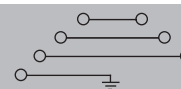

IEC 60947-7-1 (-7-2)

IEC	UL	CSA
800	600 (C)	
32	29 (C)	
4	AWG 26...10	
8 kV /		
A3 / V-0		
Rated connection		
0.5...6		
0.5...4 / 4...0.5		
12 / 0.4 x 2.5 mm		

Type	Qty.	Order No.
PMAK 4 800V	50	1221350000

Type	current	Qty.	Order No.
Width			
ZEW 35/2	8 mm	20	8630740000
SDS 0.4X2.5X75		1	9009030000

Identification systems	
	DEK 5/5
Note	

PPE 2.5/4

4 mm²

2 connections

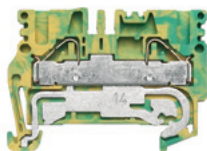

5.1 x 53 x 39	
/ 6	
0.13...6	

IEC 60947-7-2 Ex e II II 2 G D

IEC	UL	CSA	EN 60079-7
4	AWG 26...10	AWG 26...10	4
800			
8			
480 A (4 mm ²)			
3			
A3 / V-0			



Rated connection	
0.5...6	
0.5...4 / 0.5...4	
0.5...2.5	
12 / 3.0 x 0.5 mm	

PPE 2.5/4 3AN

4 mm²

3 connections

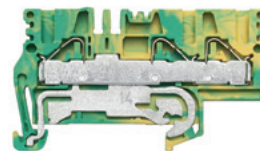

5.1 x 67 x 39	
/ 6	
0.13...6	

IEC 60947-7-2 Ex e II II 2 G D

IEC	UL	CSA	EN 60079-7
4	AWG 26...10	AWG 26...10	4
800			
8			
480 A (4 mm ²)			
3			
A3 / V-0			



Rated connection	
0.5...6	
0.5...4 / 0.5...4	
0.5...2.5	
12 / 3.0 x 0.5 mm	

In hazardous area applications, the installation instructions and the rated data specifications for accessories given in the technical appendix must be followed.

Width/Length/Height of lowest version	mm
max. current / max. cond. cross-section	A/mm ²
Max. clamping range	mm ²

Technical data

Rated data	
Rated cross-section	mm ²
Rated voltage to adjoining terminal	V
Rated impulse withstand voltage to adjacent terminal	kV
Rated short-time current	
Pollution severity	
Gauge to IEC 60947-1 / Flammability class UL94	

Clamped conductors (H05V/H07V)

Solid / stranded	mm ²
Flexible / Flexible with ferrule	mm ²
Twin wire-end ferrule	mm ²
Stripping length / Blade size	mm/-

Note

Ordering data

Version	
	green/yellow Wemid

Note

Accessories

End plate / Partition plate	Dark beige Wemid
End bracket	Dark beige Wemid
Screwdriver	Standard
Reducing sleeves	For conductors < 0.5 mm ² / AWG 20 For conductors < 1.0 mm ² / AWG 18
Cover	With lightning flash symbol



Type	Qty.	Order No.
PPE 2.5/4	50	1896170000

For 4 mm² conductors, use ferrules with a cross-section-optimised plastic collar (Order no. 9203630000).

Type	Width	Qty.	Order No.
PAP 2.5/4	2.5 mm	50	1896300000
ZEW 35	6 mm	20	9540000000
SDS 0.5X3.0X80		1	9008320000
PRH 2.5/4/1	6.16 mm	100	1916410000
PRH 2.5/4/2	6.16 mm	100	1916400000
PAD 2.5/4/4	5.1 mm	80	1916150000

Type	Qty.	Order No.
PPE 2.5/4/3AN	50	1896200000

For 4 mm² conductors, use ferrules with a cross-section-optimised plastic collar (Order no. 9203630000).

Type	Width	Qty.	Order No.
PAP 2.5/4/3AN	2.5 mm	50	1896480000
ZEW 35	6 mm	20	9540000000
SDS 0.5X3.0X80		1	9008320000
PRH 2.5/4/1	6.16 mm	100	1916410000
PRH 2.5/4/2	6.16 mm	100	1916400000
PAD 2.5/4/4	5.1 mm	80	1916150000

Identification systems (see assortment in catalogue 7)
Marking tags

Note

DEK 5/5 / WS 10/5
Detailed information for working with twin ferrules can be found in the P Series Accessories section.

DEK 5/5 / WS 10/5
Detailed information for working with twin ferrules can be found in the P Series Accessories section.

PE terminals

B

In hazardous area applications, the installation instructions and the rated data specifications for accessories given in the technical appendix must be followed.

Width/Length/Height of lowest version	mm
max. current / max. cond. cross-section	A/mm ²
Max. clamping range	mm ²

Technical data

Rated data	
Rated cross-section	mm ²
Rated voltage to adjoining terminal	V
Rated impulse withstand voltage to adjacent terminal	kV
Rated short-time current	
Pollution severity	
Gauge to IEC 60947-1 / Flammability class UL94	

Approvals

Clamped conductors (H05V/H07V)

Solid / stranded	mm ²
Flexible / Flexible with ferrule	mm ²
Twin wire-end ferrule	mm ²
Stripping length / Blade size	mm/-

Note

Ordering data

Version	green/yellow Wemid
Note	

Accessories

End plate / Partition plate	Dark beige Wemid
End bracket	Dark beige Wemid
Screwdriver	Standard
Reducing sleeves	For conductors < 0.5 mm ² / AWG 20 For conductors < 1.0 mm ² / AWG 18
Cover	With lightning flash symbol



Identification systems	(see assortment in catalogue 7) Marking tags
Note	

PPE 2.5/4 4AN

4 mm²

4 connections

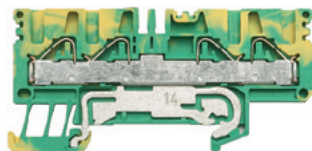

5.1 x 80 x 39	
/ 6	
0.13...6	

IEC 60947-7-2 Ex e II II 2 G D

IEC	UL	CSA	EN 60079-7
4	AWG 26...10	AWG 26...10	4
800			
8			
	480 A (4 mm ²)		
	3		
	A3 / V-0		

Rated connection

0.5...6
0.5...4 / 0.5...4
0.5...2.5
12 / 3.0 x 0.5 mm

Type	Qty.	Order No.
PPE 2.5/4/4AN	50	1896160000
For 4 mm ² conductors, use ferrules with a cross-section-optimised plastic collar (Order no. 9203630000).		

Type	Width	Qty.	Order No.
PAP 2.5/4/4AN	2.5 mm	50	1896320000
ZEW 35	6 mm	20	9540000000
SDS 0.5X3.0X80		1	9008320000
PRH 2.5/4/1	6.16 mm	100	1916410000
PRH 2.5/4/2	6.16 mm	100	1916400000
PAD 2.5/4/4	5.1 mm	80	1916150000

DEK 5/5 / WS 10/5
Detailed information for working with twin ferrules can be found in the P Series Accessories section.

PPE 6/10

10 mm²

2 connections

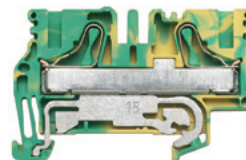

8.1 x 63.5 x 41.5	
/ 10	
1.5...10	

IEC 60947-7-2 Ex e II II 2 G D

IEC	UL	CSA	EN 60079-7
10	AWG 14...8	AWG 14...8	10
800			
8			
	1200 A (10 mm ²)		
	3		
	A4 / V-0		

Rated connection

1.5...6
1.5...10 / 1.5...10
14 / 0.6 x 3.5 mm

Type	Qty.	Order No.
PPE 6/10	25	1896180000
For 10 mm ² conductors, use ferrules with a cross-section-optimised plastic collar (Order no. 9203620000).		

Type	Width	Qty.	Order No.
PAP PDU6/10	2.5 mm	20	1896330000
ZEW 35	6 mm	20	9540000000
SDS 0.5X3.0X80		1	9008320000
PAD 6/10/4	5.3 mm	80	1916160000

WS 10/8

PPE 6/10 3AN

10 mm²

3 connections

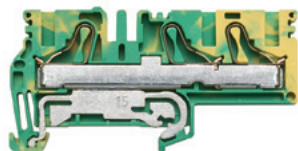

8.1 x 81.5 x 41.5
/ 10
1.5...10



IEC 60947-7-2

Ex e II



II 2 G D

IEC	UL	CSA	EN 60079-7
10	AWG 14...8	AWG 14...8	10
800			
8			
	1200 A (10 mm ²)		
	3		
	A4 / V-0		

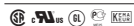

Rated connection

1.5...6

1.5...10 / 1.5...10

14 / 0.6 x 3.5 mm

Type	Qty.	Order No.
PPE 6/10/3AN	25	1896190000

For 10 mm² conductors, use ferrules with a cross-section-optimised plastic collar (Order no. 9203620000).

Type	Width	Qty.	Order No.
PAP PDU6/10/3AN	2.5 mm	20	1896340000
ZEW 35	6 mm	20	9540000000
SDS 0.5X3.0X80		1	9008320000
PAD 6/10/4	5.3 mm	80	1916160000

WS 10/8

PE terminals

B

In hazardous area applications, the installation instructions and the rated data specifications for accessories given in the technical appendix must be followed.

Width/Length/Height of lowest version	mm
max. current / max. cond. cross-section	A/mm ²
Max. clamping range	mm ²

Technical data



Rated data	
Rated cross-section	mm ²
Rated voltage to adjoining terminal	V
Rated impulse withstand voltage to adjacent terminal	kV
Rated short-time current	
Pollution severity	
Gauge to IEC 60947-1 / Flammability class UL94	
Approvals	
Clamped conductors (H05V/H07V)	
Solid / stranded	mm ²
Flexible / Flexible with ferrule	mm ²
Twin wire-end ferrule	mm ²
Stripping length / Blade size	mm/-

Note

Ordering data

Version	green/yellow Wemid
Note	

Accessories

Pluggable cross-connection	2-pole
	
End plate / Partition plate	Dark beige Wemid
End bracket	Dark beige Wemid
Screwdriver	Standard
Cover	With lightning flash symbol
	

Identification systems	(see assortment in catalogue 7) Marking tags
Note	

PPE 16

16 mm²

2 connections

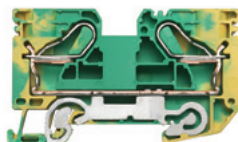

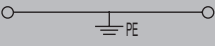
12.1 x 81 x 48	
/ 16	
2.5...16	

IEC 60947-7-2 Ex e II  II 2 G D

IEC	UL	CSA	EN 60079-7
16	AWG 14...4	AWG 14...4	16
800			
8			
1920 A (16 mm ²)			
3			
B6 / V-0			

Rated connection	
2.5...16	
2.5...16 / 2.5...16	
18 / 1.0 x 5.5 mm	

Type	Qty.	Order No.
PPE 16	10	1896210000

Type	current	Qty.	Order No.
ZQV 16/2	76 A	25	1739690000
Width			
PAP 16	2.7 mm	10	1896290000
ZEW 35	6 mm	20	9540000000
SDIS SL 1.0X4.5X125		1	1274680000
PAD 16/4	7.3 mm	80	1916170000

Note	WS 10/12
------	----------

PDK 2.5/4 PE

4 mm²

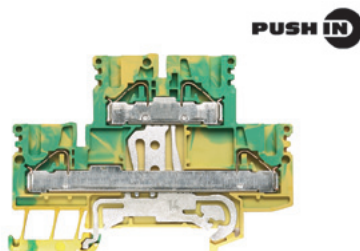

In hazardous area applications, the installation instructions and the rated data specifications for accessories given in the technical appendix must be followed.

Width/Length/Height of lowest version	mm
max. current / max. cond. cross-section	A/mm ²
Max. clamping range	mm ²

5.1 x 82.5 x 58.5	
/ 6	
0.13...6	

Technical data

Rated data	
Rated cross-section	mm ²
Rated voltage to adjoining terminal	V
Rated impulse withstand voltage to adjacent terminal	kV
Rated short-time current	
Pollution severity	
Gauge to IEC 60947-1 / Flammability class UL94	
Approvals	

IEC 60947-7-2 Ex e II II 2 G D

IEC	UL	CSA	EN 60079-7
4	AWG 26...10	AWG 26...10	4
800			
8			
480 A (4 mm ²)			
3			
A3 / V-0			

Clamped conductors (H05V/H07V)

Solid / stranded	mm ²
Flexible / Flexible with ferrule	mm ²
Twin wire-end ferrule	mm ²
Stripping length / Blade size	mm/-

Rated connection
0.5...6
0.5...4 / 0.5...4
0.5...2.5

Note

Ordering data

Version	green/yellow Wemid
---------	--------------------

Note

Type	Qty.	Order No.
PDK 2.5/4 PE	50	1918710000

For 4 mm² conductors, use ferrules with a cross-section-optimised plastic collar (Order no. 9203630000).

Accessories

End plate / Partition plate	Dark beige Wemid
End bracket	Dark beige Wemid
Screwdriver	Standard
Reducing sleeves	For conductors < 0.5 mm ² / AWG 20 For conductors < 1.0 mm ² / AWG 18
Cover	With lightning flash symbol



Type	Width	Qty.	Order No.
PAP PDK 2.5/4	2.5 mm	20	1919720000
ZEW 35	6 mm	20	9540000000
SDS 0.5X3.0X80		1	9008320000
PRH 2.5/4/1	6.16 mm	100	1916410000
PRH 2.5/4/2	6.16 mm	100	1916400000
PAD 2.5/4/4	5.1 mm	80	1916150000

Identification systems (see assortment in catalogue 7)

Marking tags

Note

DEK 5/5 / WS 10/5
Detailed information for working with twin ferrules can be found in the P Series Accessories section.

Fuse terminals

B

In hazardous area applications, the installation instructions and the rated data specifications for accessories given in the technical appendix must be followed.

Width/Length/Height of lowest version	mm
max. current / max. cond. cross-section	A/mm ²
Max. clamping range	mm ²

Technical data

Rated data	
Rated voltage to adjoining terminal	V
Rated current	A
Rated cross-section	mm ²
Rated impulse withstand voltage / Pollution severity	
Flammability class UL94	
Approvals	
Clamped conductors (H05V/H07V)	
Solid / stranded	mm ²
Flexible / Flexible with ferrule	mm ²
Blade size	
Note	

Ordering data

Version	
	Dark beige Wemid
	black
Note	

Accessories

Pluggable cross-connection	
	3-pole
	5-pole
	7-pole
	9-pole
End plate / Partition plate	
	Dark beige Wemid
	black
End bracket	
	Dark beige Wemid
Screwdriver	
	Standard
G-fuse cartridge, 5 x 20mm (IEC 60127-2)	
	0.25 A fast
	0.50 A fast
	1.00 A fast
	2.00 A fast

Identification systems	
	(see assortment in catalogue 7)
Note	
	Marking tags

PSI 6/10

10 mm²

NEW

PUSH IN

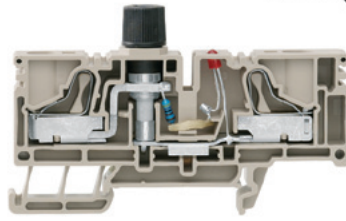

12.2 x 81 x 40.35
10 / 10
1.5...10

IEC 60947-7-1

IEC	UL	CSA
250		
6.3		
10		
	8 kV / 3	
	V-0	
Rated connection		
1.5...6		
1.5...10 / 1.5...10		
0.6 x 3.5 mm		
Note		

Type	Qty.	Order No.
PSI 6/10	25	1083050000
PSI 6/10 SW	25	1165140000
Short-circuit protection aligned individually: 10 A and 4 W.		

Type	current	Qty.	Order No.
ZQV 4/3 GE	32 A	60	1608960000
ZQV 4/5 GE	32 A	20	1608980000
ZQV 4/7 GE	32 A	20	1609000000
ZQV 4/9 GE	32 A	20	1609020000
Width			
PAP PTL/PSI 6/10	2.5 mm	20	1165320000
PAP PTL/PSI 6/10 SW	2.5 mm	20	1165330000
ZEW 35	6 mm	20	9540000000
SDS 0.5X3.0X80		1	9008320000
G 20/0.25A/F		10	0430500000
G 20/0.50A/F		10	0430600000
G 20/1.00A/F		10	0430700000
G 20/2.00A/F		10	0430900000

PSI 6/10

Overload and short-circuit protection

Type	Order No.			
PSI 6/10	1083050000			
Applications				
Arrangement	Applications			
	Only short-circuit protection		Overload and short-circuit protection	
	T _A max.	Nominal values	T _A max.	Nominal values
Individual	35 °C	2.5 W / 6.3 A		
In combination	26 °C	2.5 W / 6.3 A		

Note	
	WS 10/8
	Every second pin on the cross-connection must be broken out.

Cartridge fuses and gauge pieces for Weidmüller fuse terminals

Cartridge fuses

for terminal type

PSI 6/10



Technical data / Ordering data

G-type cartridge fuses 5 x 20 without indicators to IEC 60127-2 (VDE 0820 pt.2 BI)

Size (mm)	Nom. current (A)	Type	Qty.	Order No.
5 x 20	0.1	(F) G 20/0.10A/F	10	0430300000
breaking capacity 1500 A (at 250 V, 50 Hz, cos φ 0.7)	0.2	(F) G 20/0.20A/F	10	0430400000
	0.25	(F) G 20/0.25A/F	10	0430500000
	0.5	(F) G 20/0.50A/F	10	0430600000
	0.63	(F) G 20/0.63A/F	10	0439000000
	1.0	(F) G 20/1.00A/F	10	0430700000
	1.6	(F) G 20/1.60A/F	10	0430800000
	2.0	(F) G 20/2.00A/F	10	0430900000
	2.5	(F) G 20/2.50A/F	10	0431000000
	3.15	(F) G 20/3.15A/F	10	0431100000
	4.0	(F) G 20/4.00A/F	10	0431200000
	5.0	(F) G 20/5.00A/F	10	0431300000
	6.3	(F) G 20/6.30A/F	10	0431400000

(M) = medium-blow (F) = fast-blow

Test-disconnect terminals

B

In hazardous area applications, the installation instructions and the rated data specifications for accessories given in the technical appendix must be followed.

Width/Length/Height of lowest version	mm
max. current / max. cond. cross-section	A/mm ²
Max. clamping range	mm ²

Technical data

Rated data	
Rated voltage of feed-through terminal	V
Rated current	A
Rated cross-section	mm ²
Rated impulse withstand voltage / Pollution severity	
Gauge to IEC 60947-1 / Flammability class UL94	
Approvals	
Clamped conductors (H05V/H07V)	
Solid / stranded	mm ²
Flexible / Flexible with ferrule	mm ²
Twin wire-end ferrule	mm ²
Stripping length / Blade size	mm/-

Note

Ordering data

Version	
	Dark beige Wemid
	Blue Wemid
	Without isolator, Dark beige Wemid

Note

Accessories

Pluggable cross-connection	
	2-pole
	3-pole
	4-pole
	10-pole
	20-/24-pole
End plate / Partition plate	
	Dark beige Wemid
End bracket	
	Dark beige Wemid
Screwdriver	
	Standard
Testing / Checking	
	Test plug
Holder for cartridge fuse 5 x 20mm	
	400 V AC/DC, without LED
	10 - 36 V AC/DC, red LED
	140 - 250 V AC/DC, red LED
Module connector (max. 250 V)	
	without fittings
	with wire jumper
	With 1N4007 diode
Disconnect plug	
	removable, as replacement for release lever
Identification systems	
	(see assortment in catalogue 7)
	Marking tags
Note	

PTR 2.5/4

2.5 mm²

With isolator

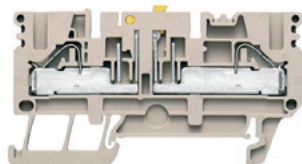

5.1 x 71 x 39.5
22 / 6
0.13...6



IEC 60947-7-1

IEC	UL	CSA
500	600 (C)	600 (C)
22	24 (C)	24 (C)
2.5	AWG 26...10	AWG 26...10
6 kV / 3		
A3 / V-0		

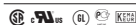

Rated connection	
0.5...6	
0.5...4 / 0.5...4	
0.5...2.5	
12 / 0.6 x 3.5 mm	

Type	Qty.	Order No.
PTR 2.5/4	50	1933950000
PTR 2.5/4 BL	50	1933970000

For 4 mm² conductors, use ferrules with a cross-section-optimised plastic collar (Order no. 9203630000).

Type	current	Qty.	Order No.
ZQV 2.5/2	24 A	60	1608860000
ZQV 2.5/3	24 A	60	1608870000
ZQV 2.5/4	24 A	60	1608880000
ZQV 2.5/10	24 A	20	1608940000
ZQV 2.5/20	24 A	20	1908960000
Width			
PAP PTR2.5/4	2.5 mm	20	1934680000
ZEW 35			
	6 mm	20	9540000000
SDS 0.5X3.0X80			
		1	9008320000
PS 2.3 RT			
	5.4 mm	20	0180400000
SIHA 3/G20			
	5.95 mm	25	7921560000
	5.95 mm	25	7921570000
	5.95 mm	25	7921600000
BEST			
	5.1 mm	50	1833100000
	5.1 mm	50	1878570000
	5.1 mm	50	1878560000
TNST			
		50	1833090000

DEK 5/5 / WS 10/5
Detailed information for working with twin ferrules can be found in the P Series Accessories section.

PTR 2.5/4 0 TNHE

2.5 mm²

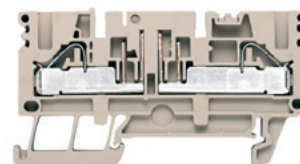

5.1 x 71 x 39.5
22 / 6
0.13...6



IEC 60947-7-1

IEC	UL	CSA
500		
22		
2.5		
6 kV / 3		
A3 / V-0		



Rated connection	
0.5...6	
0.5...4 / 0.5...4	
0.5...2.5	
12 / 0.6 x 3.5 mm	

Type	Qty.	Order No.
PTR 2.5/4 0 TNHE	50	1933910000

For 4 mm² conductors, use ferrules with a cross-section-optimised plastic collar (Order no. 9203630000).

Type	current	Qty.	Order No.
ZQV 2.5/2	24 A	60	1608860000
ZQV 2.5/3	24 A	60	1608870000
ZQV 2.5/4	24 A	60	1608880000
ZQV 2.5/10	24 A	20	1608940000
ZQV 2.5/20	24 A	20	1908960000
Width			
PAP PTR2.5/4	2.5 mm	20	1934680000
ZEW 35			
	6 mm	20	9540000000
SDS 0.5X3.0X80			
		1	9008320000
PS 2.3 RT			
	5.4 mm	20	0180400000
SIHA 3/G20			
	5.95 mm	25	7921560000
	5.95 mm	25	7921570000
	5.95 mm	25	7921600000
BEST			
	5.1 mm	50	1833100000
	5.1 mm	50	1878570000
	5.1 mm	50	1878560000
TNST			
		50	1833090000

DEK 5/5 / WS 10/5
Detailed information for working with twin ferrules can be found in the P Series Accessories section.

PTR 2.5/4 3AN

2.5 mm²

With isolator

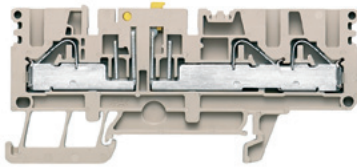

5.1 x 85 x 39.5
22 / 6
0.13...6



IEC 60947-7-1

IEC	UL	CSA
500	600 (C)	600 (C)
22	24 (C)	24 (C)
2.5	AWG 26...10	AWG 26...10
6 kV / 3		
A3 / V-0		



Rated connection

0.5...6
 0.5...4 / 0.5...4
 0.5...2.5
 12 / 0.6 x 3.5 mm

Type	Qty.	Order No.
PTR 2.5/4/3AN	50	1933980000
PTR 2.5/4/3AN BL	50	1933930000

For 4 mm² conductors, use ferrules with a cross-section-optimised plastic collar (Order no. 9203630000).

Type	current	Qty.	Order No.
ZQV 2.5/2	24 A	60	1608860000
ZQV 2.5/3	24 A	60	1608870000
ZQV 2.5/4	24 A	60	1608880000
ZQV 2.5/10	24 A	20	1608940000
ZQV 2.5/20	24 A	20	1908960000
Width			
PAP PTR2.5/4/3AN	2.5 mm	20	1934690000
ZEW 35	6 mm	20	9540000000
SDS 0.5X3.0X80		1	9008320000
PS 2.3 RT	5.4 mm	20	0180400000
SIHA 3/G20	5.95 mm	25	7921560000
SIHA 3/G20/LD 10-36V	5.95 mm	25	7921570000
SIHA 3/G20/LD 140-250V	5.95 mm	25	7921600000
BEST	5.1 mm	50	1833100000
BEST/DRBR	5.1 mm	50	1878570000
BEST/D	5.1 mm	50	1878560000
TNST		50	1833090000

DEK 5/5 / WS 10/5

Detailed information for working with twin ferrules can be found in the P Series Accessories section.

PTR 2.5/4 3AN 0 TNHE

2.5 mm²

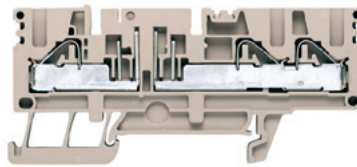

5.1 x 85 x 39.5
22 / 6
0.13...6



IEC 60947-7-1

IEC	UL	CSA
500		
22		
2.5		
6 kV / 3		
A3 / V-0		



Rated connection

0.5...6
 0.5...4 / 0.5...4
 0.5...2.5
 12 / 0.6 x 3.5 mm

Type	Qty.	Order No.
PTR 2.5/4/3AN 0 TNHE	50	1933990000

For 4 mm² conductors, use ferrules with a cross-section-optimised plastic collar (Order no. 9203630000).

Type	current	Qty.	Order No.
ZQV 2.5/2	24 A	60	1608860000
ZQV 2.5/3	24 A	60	1608870000
ZQV 2.5/4	24 A	60	1608880000
ZQV 2.5/10	24 A	20	1608940000
ZQV 2.5/20	24 A	20	1908960000
Width			
PAP PTR2.5/4/3AN	2.5 mm	20	1934690000
ZEW 35	6 mm	20	9540000000
SDS 0.5X3.0X80		1	9008320000
PS 2.3 RT	5.4 mm	20	0180400000
SIHA 3/G20	5.95 mm	25	7921560000
SIHA 3/G20/LD 10-36V	5.95 mm	25	7921570000
SIHA 3/G20/LD 140-250V	5.95 mm	25	7921600000
BEST	5.1 mm	50	1833100000
BEST/DRBR	5.1 mm	50	1878570000
BEST/D	5.1 mm	50	1878560000
TNST		50	1833090000

DEK 5/5 / WS 10/5

Detailed information for working with twin ferrules can be found in the P Series Accessories section.

PTR 2.5/4 4AN

2.5 mm²

With isolator

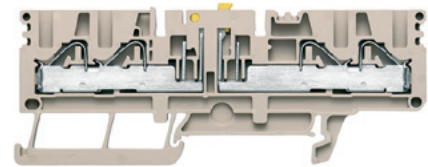

5.1 x 99 x 39.5
22 / 6
0.13...6



IEC 60947-7-1

IEC	UL	CSA
500	600 (C)	600 (C)
22	24 (C)	24 (C)
2.5	AWG 26...10	AWG 26...10
6 kV / 3		
A3 / V-0		



Rated connection

0.5...6
 0.5...4 / 0.5...4
 0.5...2.5
 12 / 0.6 x 3.5 mm

Type	Qty.	Order No.
PTR 2.5/4/4AN	50	1933940000
PTR 2.5/4/4AN BL	50	1934000000

For 4 mm² conductors, use ferrules with a cross-section-optimised plastic collar (Order no. 9203630000).

Type	current	Qty.	Order No.
ZQV 2.5/2	24 A	60	1608860000
ZQV 2.5/3	24 A	60	1608870000
ZQV 2.5/4	24 A	60	1608880000
ZQV 2.5/10	24 A	20	1608940000
ZQV 2.5/20	24 A	20	1908960000
Width			
PAP PTR2.5/4/4AN	2.5 mm	20	1934700000
ZEW 35	6 mm	20	9540000000
SDS 0.5X3.0X80		1	9008320000
PS 2.3 RT	5.4 mm	20	0180400000
SIHA 3/G20	5.95 mm	25	7921560000
SIHA 3/G20/LD 10-36V	5.95 mm	25	7921570000
SIHA 3/G20/LD 140-250V	5.95 mm	25	7921600000
BEST	5.1 mm	50	1833100000
BEST/DRBR	5.1 mm	50	1878570000
BEST/D	5.1 mm	50	1878560000
TNST		50	1833090000

DEK 5/5 / WS 10/5

Detailed information for working with twin ferrules can be found in the P Series Accessories section.

Test-disconnect terminals

B

In hazardous area applications, the installation instructions and the rated data specifications for accessories given in the technical appendix must be followed.

Width/Length/Height of lowest version	mm
max. current / max. cond. cross-section	A/mm ²
Max. clamping range	mm ²

Technical data

Rated data	
Rated voltage of feed-through terminal	V
Rated current	A
Rated cross-section	mm ²
Rated impulse withstand voltage / Pollution severity	
Gauge to IEC 60947-1 / Flammability class UL94	
Approvals	
Clamped conductors (H05V/H07V)	
Solid / stranded	mm ²
Flexible / Flexible with ferrule	mm ²
Twin wire-end ferrule	mm ²
Stripping length / Blade size	mm/-

Note

Ordering data

Version	Dark beige Wemid Blue Wemid Without isolator, Dark beige Wemid
Note	

Accessories

Pluggable cross-connection	
	2-pole 3-pole 4-pole 10-pole 20-/24-pole
End plate / Partition plate	Dark beige Wemid
End bracket	Dark beige Wemid
Screwdriver	Standard
Testing / Checking	Test plug
Holder for cartridge fuse 5 x 20mm	400 V AC/DC, without LED 10 - 36 V AC/DC, red LED 140 - 250 V AC/DC, red LED
Module connector (max. 250 V)	without fittings with wire jumper With 1N4007 diode
Disconnect plug	removable, as replacement for release lever

Identification systems	(see assortment in catalogue 7) Marking tags
Note	

PTR 2.5/4 4AN 0 TNHE

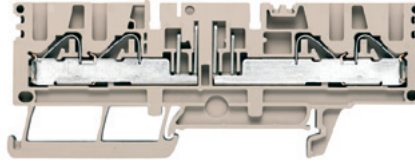
2.5 mm²

5.1 x 99 x 39.5
22 / 6
0.13...6

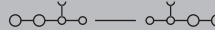

IEC 60947-7-1

IEC	UL	CSA
500		
22		
2.5		
	6 kV / 3	
	A3 / V-0	



Rated connection	
0.5...6	
0.5...4 / 0.5...4	
0.5...2.5	
12 / 0.6 x 3.5 mm	

Type	Qty.	Order No.
PTR 2.5/4/4AN 0 TNHE	50	1933890000
For 4 mm ² conductors, use ferrules with a cross-section-optimised plastic collar (Order no. 9203630000).		

Type	current	Qty.	Order No.
ZQV 2.5/2	24 A	60	1608860000
ZQV 2.5/3	24 A	60	1608870000
ZQV 2.5/4	24 A	60	1608880000
ZQV 2.5/10	24 A	20	1608940000
ZQV 2.5/20	24 A	20	1908960000
Width			
PAP PTR2.5/4/4AN	2.5 mm	20	1934700000
ZEW 35	6 mm	20	9540000000
SDS 0.5X3.0X80		1	9008320000
PS 2.3 RT	5.4 mm	20	0180400000
SIHA 3/G20	5.95 mm	25	7921560000
SIHA 3/G20/LD 10-36V	5.95 mm	25	7921570000
SIHA 3/G20/LD 140-250V	5.95 mm	25	7921600000
BEST	5.1 mm	50	1833100000
BEST/DRBR	5.1 mm	50	1878570000
BEST/D	5.1 mm	50	1878560000
TNST		50	1833090000

DEK 5/5 / WS 10/5
Detailed information for working with twin ferrules can be found in the P Series Accessories section.

PDL 4/TR/DU 0 TNHE

4 mm²



5.1 x 100 x 49.5
/ 4
0.08...4

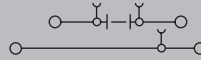

IEC 60947-7-1

IEC	UL	CSA
400	150 (C)	300 (B)
20	17 (C)	6.3 (B)
4	AWG 28...10	AWG 28...10
4 kV / 3		
A3 / V-0		



Rated connection

0.5...4 / 1.5...4
0.5...4 / 0.5...4
0.5...1.5
12 / 3.0 x 0.5 mm

PDL 4/TR/DU/PE 0 TNHE

4 mm²

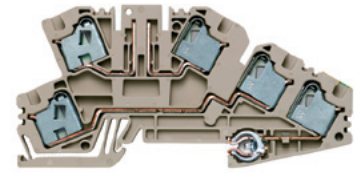

5.1 x 100 x 49.5
/ 4
0.08...4

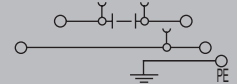

IEC 60947-7-1 (-7-2)

IEC	UL	CSA
400	300 (D)	300 (B)
20	10 (D)	6.3 (B)
4	AWG 28...10	AWG 28...10
4 kV / 3		
A3 / V-0		



Rated connection

0.5...4 / 1.5...4
0.5...4 / 0.5...4
0.5...1.5
12 / 3.0 x 0.5 mm

In hazardous area applications, the installation instructions and the rated data specifications for accessories given in the technical appendix must be followed.

Width/Length/Height of lowest version	mm
max. current / max. cond. cross-section	A/mm ²
Max. clamping range	mm ²

Technical data

Rated data	
Rated voltage of feed-through terminal	V
Rated current	A
Rated cross-section	mm ²
Rated impulse withstand voltage / Pollution severity	
Gauge to IEC 60947-1 / Flammability class UL94	
Approvals	
Clamped conductors (H05V/H07V)	
Solid / stranded	mm ²
Flexible / Flexible with ferrule	mm ²
Twin wire-end ferrule	mm ²
Stripping length / Blade size	mm/-
Note	

Ordering data

Version	
Dark beige Wemid	
Without isolator, Dark beige Wemid	
Note	

Accessories

Pluggable cross-connection	
2-pole	
3-pole	
4-pole	
10-pole	
20-/24-pole	
End plate / Partition plate	
Dark beige Wemid	
End bracket	
Dark beige Wemid	
Screwdriver	
Standard	
Holder for cartridge fuse 5 x 20mm	
400 V AC/DC, without LED	
10 - 36 V AC/DC, red LED	
140 - 250 V AC/DC, red LED	
Module connector (max. 250 V)	
without fittings	
with wire jumper	
With 1N4007 diode	
Disconnect plug	
removable, as replacement for release lever	
Identification systems (see assortment in catalogue 7)	
Marking tags	
Note	

Type	Qty.	Order No.
PDL 4/TR/DU 0 TNHE	50	1899210000
...without disconnecting lever. Suitable for the SIHA 3 fuse holder with G fuse, for the BEST component plug and for the TNST isolating plug.		

Type	current	Qty.	Order No.
ZQV 2.5/2	24 A	60	1608860000
ZQV 2.5/3	24 A	60	1608870000
ZQV 2.5/4	24 A	60	1608880000
ZQV 2.5/10	24 A	20	1608940000
ZQV 2.5/20	24 A	20	1908960000
Width			
PAP PDL4	1.5 mm	20	1883210000
ZEW 35/2			
	8 mm	20	8630740000
SDS 0.5X3.0X80			
		1	9008320000
SIHA 3/G20			
	5.95 mm	25	7921560000
SIHA 3/G20/LD 10-36V	5.95 mm	25	7921570000
SIHA 3/G20/LD 140-250V	5.95 mm	25	7921600000
BEST			
	5.1 mm	50	1833100000
BEST/DRBR	5.1 mm	50	1878570000
BEST/D	5.1 mm	50	1878560000
TNST			
		50	1833090000

Type	Qty.	Order No.
PDL 4/TR/DU/PE 0 TNHE	50	1899220000
...without disconnecting lever. Suitable for the SIHA 3 fuse holder with G fuse, for the BEST component plug and for the TNST isolating plug.		

Type	current	Qty.	Order No.
ZQV 2.5/2	24 A	60	1608860000
ZQV 2.5/3	24 A	60	1608870000
ZQV 2.5/4	24 A	60	1608880000
ZQV 2.5/10	24 A	20	1608940000
ZQV 2.5/20	24 A	20	1908960000
Width			
PAP PDL4	1.5 mm	20	1883210000
ZEW 35/2			
	8 mm	20	8630740000
SDS 0.5X3.0X80			
		1	9008320000
SIHA 3/G20			
	5.95 mm	25	7921560000
SIHA 3/G20/LD 10-36V	5.95 mm	25	7921570000
SIHA 3/G20/LD 140-250V	5.95 mm	25	7921600000
BEST			
	5.1 mm	50	1833100000
BEST/DRBR	5.1 mm	50	1878570000
BEST/D	5.1 mm	50	1878560000
TNST			
		50	1833090000

DEK 5/5 / WS 10/5	
Detailed information for working with twin ferrules can be found in the P Series Accessories section.	

Test-disconnect terminals

B

In hazardous area applications, the installation instructions and the rated data specifications for accessories given in the technical appendix must be followed.

Width/Length/Height of lowest version	mm
max. current / max. cond. cross-section	A/mm ²
Max. clamping range	mm ²

Technical data

Rated data	
Rated voltage of feed-through terminal	V
Rated current	A
Rated cross-section	mm ²
Rated impulse withstand voltage / Pollution severity	
Gauge to IEC 60947-1 / Flammability class UL94	
Approvals	
Clamped conductors (H05V/H07V)	
Solid / stranded	mm ²
Flexible / Flexible with ferrule	mm ²
Twin wire-end ferrule	mm ²
Stripping length / Blade size	mm/-
Note	

Ordering data

Version	
	Dark beige Wemid
	Without isolator, Dark beige Wemid
Note	

Accessories

Pluggable cross-connection	
	2-pole
	3-pole
	4-pole
	10-pole
	20-/24-pole
End plate / Partition plate	
	Dark beige Wemid
End bracket	
	Dark beige Wemid
Screwdriver	
	Standard
Holder for cartridge fuse 5 x 20mm	
	400 V AC/DC, without LED
	10 - 36 V AC/DC, red LED
	140 - 250 V AC/DC, red LED
Module connector (max. 250 V)	
	without fittings
	with wire jumper
	With 1N4007 diode
Disconnect plug	
	removable, as replacement for release lever

Identification systems	(see assortment in catalogue 7)
	Marking tags
Note	

PDL 4/TR/DU

4 mm²

With isolator

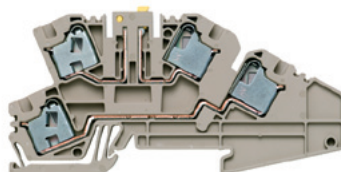

5.1 x 100 x 49.5	
/ 4	
0.08...4	

IEC 60947-7-1

IEC	UL	CSA
400	150 (C)	300 (B)
20	17 (C)	20 (B)
4	AWG 28...10	AWG 28...10
4 kV / 3		
A3 / V-0		

Rated connection	
0.5...4 / 1.5...4	
0.5...4 / 0.5...4	
0.5...1.5	
12 / 3.0 x 0.5 mm	

Type	Qty.	Order No.
PDL 4/TR/DU	50	1899190000
Without isolator: PDL 4 TR/DU 0 TNHE Order no.: 1899210000		

Type	current	Qty.	Order No.
ZQV 2.5/2	24 A	60	1608860000
ZQV 2.5/3	24 A	60	1608870000
ZQV 2.5/4	24 A	60	1608880000
ZQV 2.5/10	24 A	20	1608940000
ZQV 2.5/20	24 A	20	1908960000
Width			
PAP PDL4	1.5 mm	20	1883210000
ZEW 35/2			
	8 mm	20	8630740000
SDS 0.5X3.0X80			
		1	9008320000
SIHA 3/G20			
	5.95 mm	25	7921560000
	5.95 mm	25	7921570000
	5.95 mm	25	7921600000
BEST			
	5.1 mm	50	1833100000
	5.1 mm	50	1878570000
	5.1 mm	50	1878560000
TNST			
		50	1833090000

Identification systems	(see assortment in catalogue 7)
	DEK 5/5 / WS 10/5
Note	
Detailed information for working with twin ferrules can be found in the P Series Accessories section.	

PDL 4/TR/DU/PE

4 mm²

With isolator

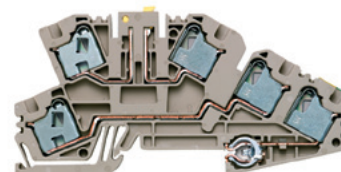

5.1 x 100 x 49.5	
/ 4	
0.08...4	

IEC 60947-7-1 (-7-2)

IEC	UL	CSA
400	300 (D)	300 (B)
20	10 (D)	20 (B)
4	AWG 28...10	AWG 28...10
4 kV / 3		
A3 / V-0		

Rated connection	
0.5...4 / 1.5...4	
0.5...4 / 0.5...4	
0.5...1.5	
12 / 3.0 x 0.5 mm	

Type	Qty.	Order No.
PDL 4/TR/DU/PE	50	1899200000
Without isolator: PDL 4 TR/DU/PE 0 TNHE Order no.: 1899220000		

Type	current	Qty.	Order No.
ZQV 2.5/2	24 A	60	1608860000
ZQV 2.5/3	24 A	60	1608870000
ZQV 2.5/4	24 A	60	1608880000
ZQV 2.5/10	24 A	20	1608940000
ZQV 2.5/20	24 A	20	1908960000
Width			
PAP PDL4	1.5 mm	20	1883210000
ZEW 35/2			
	8 mm	20	8630740000
SDS 0.5X3.0X80			
		1	9008320000
SIHA 3/G20			
	5.95 mm	25	7921560000
	5.95 mm	25	7921570000
	5.95 mm	25	7921600000
BEST			
	5.1 mm	50	1833100000
	5.1 mm	50	1878570000
	5.1 mm	50	1878560000
TNST			
		50	1833090000

Identification systems	(see assortment in catalogue 7)
	DEK 5/5 / WS 10/5
Note	
Detailed information for working with twin ferrules can be found in the P Series Accessories section.	

PTL 6/10

10 mm²

NEW

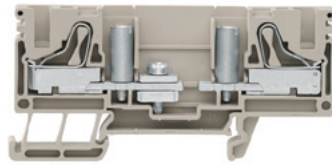

8.1 x 82 x 40.35
/ 10
1.5...10

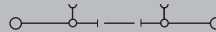

IEC 60947-7-1

IEC	UL	CSA
800	600 (C)	
57	45 (C)	
10	AWG 16...16	
8 kV / 3		
A5 / V-0		
Rated connection		
1.5...6		
1.5...10 / 1.5...10		
14 / 0.6 x 3.5 mm		

PTD 6/10

10 mm²

NEW

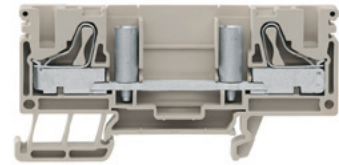

8.1 x 82 x 40.35
/ 10
1.5...10

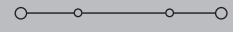

IEC 60947-7-1

IEC	UL	CSA
800	600 (C)	
57	45 (C)	
10	AWG 16...16	
8 kV / 3		
A5 / V-0		
Rated connection		
1.5...6		
1.5...10 / 1.5...10		
14 / 0.6 x 3.5 mm		

In hazardous area applications, the installation instructions and the rated data specifications for accessories given in the technical appendix must be followed.

Width/Length/Height of lowest version	mm
max. current / max. cond. cross-section	A/mm ²
Max. clamping range	mm ²

Technical data

Rated data	
Rated voltage of feed-through terminal	V
Rated current	A
Rated cross-section	mm ²
Rated impulse withstand voltage / Pollution severity	
Gauge to IEC 60947-1 / Flammability class UL94	
Approvals	
Clamped conductors (H05V/H07V)	
Solid / stranded	mm ²
Flexible / Flexible with ferrule	mm ²
Twin wire-end ferrule	mm ²
Stripping length / Blade size	mm/-
Note	

Ordering data

Version	
	Dark beige Wernid
Note	

Type	Qty.	Order No.
PTL 6/10/STB	50	1084780000

Type	Qty.	Order No.
PTD 6/10/STB	50	1084790000

Accessories

End plate / Partition plate	Dark beige Wernid black
End bracket	Dark beige Wernid
Screwdriver	Standard
Miscellaneous accessories	Short-circuit plug, 2-pole
Threaded bushing	Standard
Screwable cross-connection	2-pole 3-pole 4-pole 10-pole
Testing / Checking	Socket - blue Socket - yellow Socket - green Socket - magenta Socket Socket - blue Socket - yellow Socket - green Socket - magenta Socket

Type	Width	Qty.	Order No.
PAP PTL/PSI 6/10	2.5 mm	20	1165320000
PAP PTL/PSI 6/10 SW	2.5 mm	20	1165330000
ZEW 35	6 mm	20	9540000000
SDS 0.5X3.0X80		1	9008320000
QS 2/8/4	12 mm	20	0270960000
GWHUE M3 WTL6		50	1255010000
current			
WQV 6/2	57 A	50	1052360000
WQV 6/3	57 A	50	1054760000
WQV 6/4	57 A	50	1054860000
WQV 6/10	57 A	20	1052260000
Width			
STB 21.6/45 BL	6.1 mm	50	1936290000
STB 21.6/45 GE	6.1 mm	50	1936240000
STB 21.6/45 GN	6.1 mm	50	1936250000
STB 21.6/45 VI	6.1 mm	50	1936260000
STB 14/D6/4/M3 SAK10		500	2012420000
STB 36.8/IH/BL WTL6/1	6 mm	50	1847790000
STB 36.8/IH/GE WTL6/1	6 mm	50	1847760000
STB 36.8/IH/GN WTL6/1	6 mm	50	1847770000
STB 36.8/IH/VI WTL6/1	6 mm	50	1847780000
STB 36.8/IH/DB WTL6/1	6 mm	50	1847740000

Type	Width	Qty.	Order No.
PAP PTL/PSI 6/10	2.5 mm	20	1165320000
PAP PTL/PSI 6/10 SW	2.5 mm	20	1165330000
ZEW 35	6 mm	20	9540000000
SDS 0.5X3.0X80		1	9008320000
QS 2/8/4	12 mm	20	0270960000
GWHUE M3 WTL6		50	1255010000
current			
WQV 6/2	57 A	50	1052360000
WQV 6/3	57 A	50	1054760000
WQV 6/4	57 A	50	1054860000
WQV 6/10	57 A	20	1052260000
Width			
STB 21.6/45 BL	6.1 mm	50	1936290000
STB 21.6/45 GE	6.1 mm	50	1936240000
STB 21.6/45 GN	6.1 mm	50	1936250000
STB 21.6/45 VI	6.1 mm	50	1936260000
STB 14/D6/4/M3 SAK10		500	2012420000
STB 36.8/IH/BL WTL6/1	6 mm	50	1847790000
STB 36.8/IH/GE WTL6/1	6 mm	50	1847760000
STB 36.8/IH/GN WTL6/1	6 mm	50	1847770000
STB 36.8/IH/VI WTL6/1	6 mm	50	1847780000
STB 36.8/IH/DB WTL6/1	6 mm	50	1847740000

Identification systems	(see assortment in catalogue 7) Marking tags
Note	

DEK 5/8	
Note	

DEK 5/8	
Note	

Distribution terminal blocks for simple maintenance



A cost-effective solution for building and facility installations: with "PUSH IN" connections

This addition to Weidmüller's comprehensive line of "PUSH IN" terminal block products speeds up your installation while also providing better power specifications in a smaller size.

It offers key advantages wherever solid wires or wires with ferrules are being connected.

Quick and safe

A universal wire connection range from 2.5 to 16 mm². Solid and flexible conductors with wire-end ferrules can be connected using this connection system.

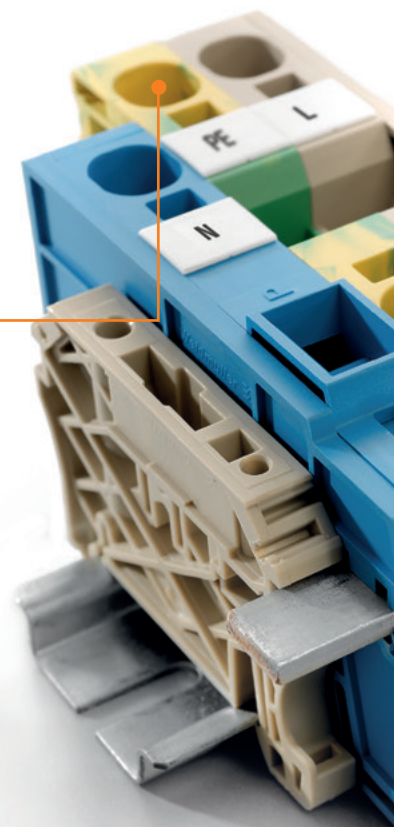
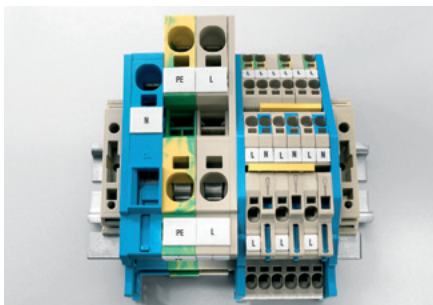

PUSH IN with screw combination

The large cross-section of screw terminals can be combined with PUSH IN terminals.

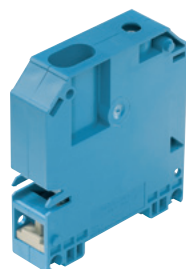

Increased flexibility
Simple to swap-out PDL terminals from the group when connected with the PDU 16S.

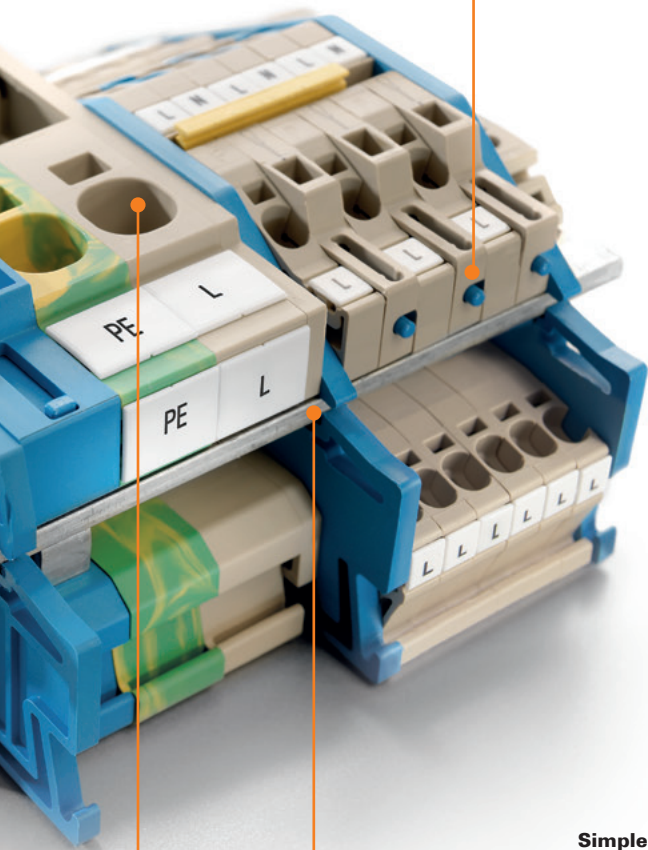

Simple handling
The asymmetric design of the terminal enables the neutral-wire busbar to be bypassed.



Actuator and installation terminals

Feed-through terminals

PDU 16S

16 mm²

NEW

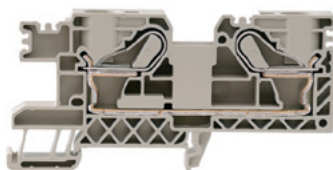

12.1 x 96.5 x 48
/ 16
2.5...16

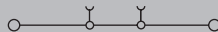

In hazardous area applications, the installation instructions and the rated data specifications for accessories given in the technical appendix must be followed.

Width/Length/Height of lowest version	mm
max. current / max. cond. cross-section	A/mm ²
Max. clamping range	mm ²

Technical data

Rated data	
Rated voltage	V
Rated current	A
Rated cross-section	mm ²
Rated impulse withstand voltage / Pollution severity	
Gauge to IEC 60947-1 / Flammability class UL94	
Approvals	
Clamped conductors (H05V/H07V)	
Solid / stranded	mm ²
Flexible / Flexible with ferrule	mm ²
Twin wire-end ferrule	mm ²
Stripping length / Blade size	mm/-

Note

Ordering data

Version	Dark beige Wemid
Note	

Accessories

Pluggable cross-connection	2-pole
End plate / Partition plate	Dark beige Wemid
End bracket	Dark beige Wemid
Screwdriver	Standard
Cover	With lightning flash symbol

IEC	UL	CSA
800		
76		
16		
	8 kV / 3	
	B6 / V-0	

Rated connection	
2.5...16	
2.5...16 / 2.5...16	
18 / 1.0 x 5.5 mm	

Type	Qty.	Order No.
PDU 16S	25	1139580000

Type	current	Qty.	Order No.
ZQV 16/2	76 A	25	1739690000
Width			
PAP PDU16S	2.7 mm	10	1139910000
ZEW 35	6 mm	20	9540000000
SDIS SL 1.0X4.5X125		1	1274680000
PAD 16/4	7.3 mm	80	1916170000

Identification systems	(see assortment in catalogue 7)
	Marking tags
Note	

WS 12/8

PE terminals

PPE 16S

16 mm²

NEW

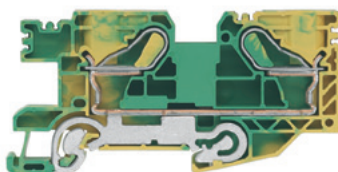

In hazardous area applications, the installation instructions and the rated data specifications for accessories given in the technical appendix must be followed.

Width/Length/Height of lowest version	mm
max. current / max. cond. cross-section	A/mm ²
Max. clamping range	mm ²

12.1 x 96.5 x 48
/ 16
2.5...16



Technical data

Rated data	
Rated cross-section	mm ²
Rated voltage to adjoining terminal	V
Rated impulse withstand voltage to adjacent terminal	kV
Rated short-time current	
Pollution severity	
Flammability class UL94	
Approvals	

IEC 60947-7-2

IEC	UL	CSA
16		
800		
8		
	1920 A (16 mm ²)	
	3	
	V-0	

Clamped conductors (H05V/H07V)	
Solid / stranded	mm ²
Flexible / Flexible with ferrule	mm ²
Blade size	

Rated connection	
2.5...16	
2.5...16 / 2.5...16	
1.0 x 5.5 mm	

Note

Ordering data

Version	green/yellow Wemid
---------	--------------------

Type	Qty.	Order No.
PPE 16S	10	1139570000

Note

Accessories

Pluggable cross-connection	2-pole
----------------------------	--------



End plate / Partition plate	Dark beige Wemid
-----------------------------	------------------

End bracket	Dark beige Wemid
-------------	------------------

Screwdriver	Standard
-------------	----------

Cover	With lightning flash symbol
-------	-----------------------------



Type	current	Qty.	Order No.
ZQV 16/2	76 A	25	1739690000

Width			
PAP PDU16S	2.7 mm	10	1139910000

ZEW 35	6 mm	20	9540000000
--------	------	----	------------

SDIS SL 1.0X4.5X125		1	1274680000
---------------------	--	---	------------

PAD 16/4	7.3 mm	80	1916170000
----------	--------	----	------------

Identification systems	(see assortment in catalogue 7)
	Marking tags

WS 10/12

Note

Actuator and installation terminals

Neutral conductor disconnect terminals

In hazardous area applications, the installation instructions and the rated data specifications for accessories given in the technical appendix must be followed.

Width/Length/Height of lowest version	mm
max. current / max. cond. cross-section	A/mm ²
Max. clamping range	mm ²

Technical data

Rated data	
Rated voltage	V
Rated current	A
Rated cross-section	mm ²
Rated impulse withstand voltage / Pollution severity	
Gauge to IEC 60947-1 / Flammability class UL94	
Approvals	
Clamped conductors (H05V/H07V)	
Solid / stranded	mm ²
Flexible / Flexible with ferrule	mm ²
Twin wire-end ferrule	mm ²
Stripping length / Blade size	mm/-

Note

Ordering data

Version	Blue Wemid
Note	

Accessories

Pluggable cross-connection	
	2-pole
	3-pole
	4-pole
	10-pole
	20-/24-pole
Support bracket for 10 x 3 (required every 20 cm)	
	Blue Wemid
	For a vertical installation position
End bracket	
	Dark beige Wemid
Screwdriver	
	Standard
Busbar 10 x 3 (140 A)	
	OK, Busbar up to OK, TS35 = 25.5 mm
Clamping yoke for power supply to 10 x 3 busbars	
	Rigid / flexible 0.5 - 6 / 4 mm ²
	Rigid / flexible 6 - 16 mm ²
	Flexible 16 - 35 mm ²

Identification systems	(see assortment in catalogue 7)
Note	Marking tags

PNT 2.5/4

4 mm²

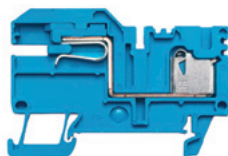

5.1 x 63.5 x 48.5	
/ 6	
0.08...6	

IEC 60947-7-1

IEC	UL	CSA
250		
32		
4		
	4 kV / 3	
	A3 / V-0	
Rated connection		
0.5...6		
2.5...4 / 0.5...4		
...1.5		
12 / 3.0 x 0.5 mm		

Type	Qty.	Order No.
PNT 2.5/4	50	1896360000

Type	current	Qty.	Order No.
ZQV 2.5/2	24 A	60	1608860000
ZQV 2.5/3	24 A	60	1608870000
ZQV 2.5/4	24 A	60	1608880000
ZQV 2.5/10	24 A	20	1608940000
ZQV 2.5/20	24 A	20	1908960000
Width			
PHP PNT 2.5/4	3 mm	20	1896390000
PHP PNT 2.5/4 SO	3 mm	20	1916790000
ZEW 35	6 mm	20	9540000000
SDS 0.5X3.0X80		1	9008320000
SSCH 10X3X1000 CU/SN	10 mm	1	0348900000
ZF 4 S BL	6.1 mm	50	1814660000
ZB 16K BL	10 mm	50	0502880000
ZB 35/M6X16	14 mm	20	0266500000

DEK 5/5 / WS 10/5

PNT 6/10

10 mm²

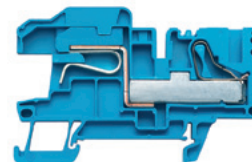

8.1 x 72.5 x 46.5	
/ 10	
1.5...10	

IEC 60947-7-1

IEC	UL	CSA
250		
41		
10		
	8 kV / 3	
	A4 / V-0	
Rated connection		
1.5...6		
1.5...10 / 1.5...10		
14 / 0.6 x 3.5 mm		

Type	Qty.	Order No.
PNT 6/10	25	1896370000

Type	current	Qty.	Order No.
ZQV 6N/2		60	1906210000
ZQV 6N/3		60	1906220000
ZQV 6N/4		60	1906230000
ZQV 6N/20		20	1906240000
Width			
PHP PNT 6/10	3 mm	10	1896100000
PHP PNT 6/10 SO	3 mm	10	1919710000
ZEW 35	6 mm	20	9540000000
SDS 0.5X3.0X80		1	9008320000
SSCH 10X3X1000 CU/SN	10 mm	1	0348900000
ZF 4 S BL	6.1 mm	50	1814660000
ZB 16K BL	10 mm	50	0502880000
ZB 35/M6X16	14 mm	20	0266500000

WS 10/8

PNT 16

16 mm²

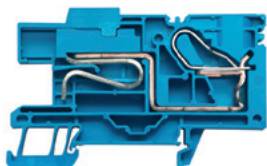

12.1 x 80.5 x 50
/ 16
2.5...16



IEC	UL	CSA
400		
76		
16		
	8 kV / 3	
	B6 / V-0	



Rated connection

2.5...16
2.5...16 / 2.5...16

18 / 1.0 x 5.5 mm

Type	Qty.	Order No.
PNT 16	10	1896350000

Type	current	Qty.	Order No.
Width			
PHP PNT16	3 mm	10	1896380000
PHP PNT16 SO	3 mm	10	1919690000
ZEW 35	6 mm	20	9540000000
SDIS SL 1.0X4.5X125		1	1274680000
SSCH 10X3X1000 CU/SN	10 mm	1	0348900000
ZF 4 S BL	6.1 mm	50	1814660000
ZB 16K BL	10 mm	50	0502880000
ZB 35/M6X16	14 mm	20	0266500000

WS 10/12

Actuator and installation terminals

Distribution terminals for 10 x 3 mm

In hazardous area applications, the installation instructions and the rated data specifications for accessories given in the technical appendix must be followed.

Width/Length/Height of lowest version	mm
max. current / max. cond. cross-section	A/mm ²
Max. clamping range	mm ²





Technical data

Rated data	
Rated voltage	V
Rated current	A
Rated cross-section	mm ²
Rated impulse withstand voltage / Pollution severity Gauge to IEC 60947-1 / Flammability class UL94	
Approvals	
Clamped conductors (H05V/H07V)	
Solid / stranded	mm ²
Flexible / Flexible with ferrule	mm ²
Twin wire-end ferrule	mm ²
Stripping length / Blade size	mm/-
Note	

Ordering data

Version	
	Dark beige Wemid
Note	

Accessories

Pluggable cross-connection	
	2-pole
	3-pole
	4-pole
	10-pole
End plate / Partition plate	
	Dark beige Wemid
Support bracket for 10 x 3 (required every 20 cm)	
	Blue Wemid For a vertical installation position
End bracket	
	Dark beige Wemid
Screwdriver	
	Standard
Busbar 10 x 3 (140 A)	
	OK, Busbar up to OK, TS35 = 25.5 mm
Clamping yoke for power supply to 10 x 3 busbars	
	Rigid / flexible 0.5 - 6 / 4 mm ²
	Rigid / flexible 6 - 16 mm ²
	Flexible 16 - 35 mm ²

Identification systems	(see assortment in catalogue 7)
	Marking tags
Note	

PDL 4 S/NT/L/PE

4 mm²

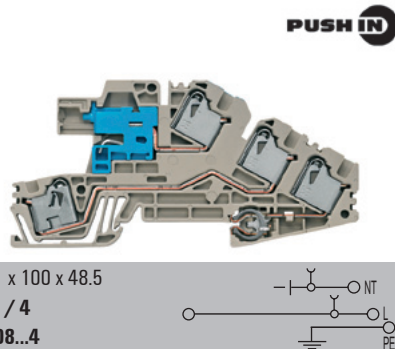

5.1 x 100 x 48.5	
36 / 4	
0.08...4	

IEC 60947-7-1 (-7-2)

IEC	UL	CSA
400		
32		
4		
	6 kV / 3	
	A3 / V-0	
Rated connection		
0.5...4 / 1.5...4		
0.5...4 / 0.5...4		
0.5...1.5		
12 / 3.0 x 0.5 mm		
Note		

Type	Qty.	Order No.
PDL 4 S/NT/L/PE	50	1837060000
Note		

Type	current	Qty.	Order No.
ZQV 2.5/2	24 A	60	1608860000
ZQV 2.5/3	24 A	60	1608870000
ZQV 2.5/4	24 A	60	1608880000
ZQV 2.5/10	24 A	20	1608940000
Width			
PAP PDL4S	1.5 mm	20	1837070000
PHP PDL	3 mm	20	1837090000
PHP PDL SO	3 mm	20	1837080000
Note			
ZEW 35/2	8 mm	20	8630740000
SDIS 0.4X2.5X75		1	9008370000
SSCH 10X3X1000 CU/SN	10 mm	1	0348900000
ZF 4 S BL	6.1 mm	50	1814660000
ZB 16 ZKSC	10 mm	50	0316600000
ZB 35/M6X16	14 mm	20	0266500000

Identification systems	(see assortment in catalogue 7)
	Marking tags
Note	

PDL 4 S/L/L

4 mm²

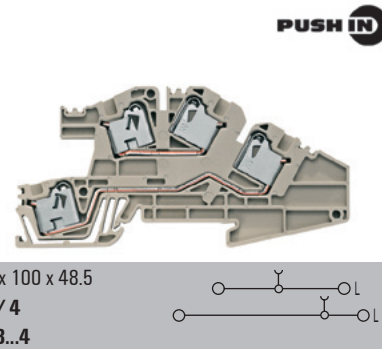

5.1 x 100 x 48.5	
36 / 4	
0.08...4	

IEC 60947-7-1

IEC	UL	CSA
400		
32		
4		
	6 kV / 3	
	A3 / V-0	
Rated connection		
0.5...4 / 1.5...4		
0.5...4 / 0.5...4		
0.5...1.5		
12 / 3.0 x 0.5 mm		
Note		

Type	Qty.	Order No.
PDL 4 S/L/L	50	1837030000
Note		

Type	current	Qty.	Order No.
ZQV 2.5/2	24 A	60	1608860000
ZQV 2.5/3	24 A	60	1608870000
ZQV 2.5/4	24 A	60	1608880000
ZQV 2.5/10	24 A	20	1608940000
Width			
PAP PDL4S	1.5 mm	20	1837070000
PHP PDL	3 mm	20	1837090000
PHP PDL SO	3 mm	20	1837080000
Note			
ZEW 35/2	8 mm	20	8630740000
SDIS 0.4X2.5X75		1	9008370000
SSCH 10X3X1000 CU/SN	10 mm	1	0348900000
ZF 4 S BL	6.1 mm	50	1814660000
ZB 16 ZKSC	10 mm	50	0316600000
ZB 35/M6X16	14 mm	20	0266500000

Identification systems	(see assortment in catalogue 7)
	Marking tags
Note	

PDL 4 S/L

4 mm²



5.1 x 100 x 48.5
36 / 4
0.08...4

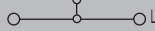

IEC 60947-7-1

IEC	UL	CSA
400		
32		
4		
6 kV / 3 A3 / V-0		



Rated connection

0.5...4 / 1.5...4
0.5...4 / 0.5...4
0.5...1.5
12 / 3.0 x 0.5 mm

Type	Qty.	Order No.
PDL 4 S/L	50	1847610000

Type	current	Qty.	Order No.
ZQV 2.5/2	24 A	60	1608860000
ZQV 2.5/3	24 A	60	1608870000
ZQV 2.5/4	24 A	60	1608880000
ZQV 2.5/10	24 A	20	1608940000
Width			
PAP PDL4S	1.5 mm	20	1837070000
PHP PDL	3 mm	20	1837090000
PHP PDL SO	3 mm	20	1837080000
ZEW 35/2	8 mm	20	8630740000
SDIS 0.4X2.5X75		1	9008370000
SSCH 10X3X1000 CU/SN	10 mm	1	0348900000
ZF 4 S BL	6.1 mm	50	1814660000
ZB 16 ZKSC	10 mm	50	0316600000
ZB 35/M6X16	14 mm	20	0266500000

DEK 5/5

PDL 4 S/N/L/PE

4 mm²

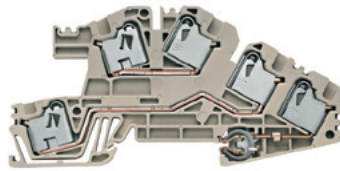

5.1 x 100 x 48.5
36 / 4
0.08...4

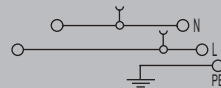

IEC 60947-7-1 (-7-2)

IEC	UL	CSA
400		
32		
4		
6 kV / 3 A3 / V-0		



Rated connection

0.5...4 / 1.5...4
0.5...4 / 0.5...4
0.5...1.5
12 / 3.0 x 0.5 mm

Type	Qty.	Order No.
PDL 4 S/N/L/PE	50	1837050000

Type	current	Qty.	Order No.
ZQV 2.5/2	24 A	60	1608860000
ZQV 2.5/3	24 A	60	1608870000
ZQV 2.5/4	24 A	60	1608880000
ZQV 2.5/10	24 A	20	1608940000
Width			
PAP PDL4S	1.5 mm	20	1837070000
PHP PDL	3 mm	20	1837090000
PHP PDL SO	3 mm	20	1837080000
ZEW 35/2	8 mm	20	8630740000
SDIS 0.4X2.5X75		1	9008370000
SSCH 10X3X1000 CU/SN	10 mm	1	0348900000
ZF 4 S BL	6.1 mm	50	1814660000
ZB 16 ZKSC	10 mm	50	0316600000
ZB 35/M6X16	14 mm	20	0266500000

DEK 5/5

PDL 4 S/N/L

4 mm²



5.1 x 100 x 48.5
36 / 4
0.08...4



IEC 60947-7-1

IEC	UL	CSA
400		
32		
4		
6 kV / 3 A3 / V-0		



Rated connection

0.5...4 / 1.5...4
0.5...4 / 0.5...4
0.5...1.5
12 / 3.0 x 0.5 mm

Type	Qty.	Order No.
PDL 4 S/N/L	50	1847630000

Type	current	Qty.	Order No.
ZQV 2.5/2	24 A	60	1608860000
ZQV 2.5/3	24 A	60	1608870000
ZQV 2.5/4	24 A	60	1608880000
ZQV 2.5/10	24 A	20	1608940000
Width			
PAP PDL4S	1.5 mm	20	1837070000
PHP PDL	3 mm	20	1837090000
PHP PDL SO	3 mm	20	1837080000
ZEW 35/2	8 mm	20	8630740000
SDIS 0.4X2.5X75		1	9008370000
SSCH 10X3X1000 CU/SN	10 mm	1	0348900000
ZF 4 S BL	6.1 mm	50	1814660000
ZB 16 ZKSC	10 mm	50	0316600000
ZB 35/M6X16	14 mm	20	0266500000

DEK 5/5

Actuator and installation terminals

Distribution terminals for 10 x 3 mm

In hazardous area applications, the installation instructions and the rated data specifications for accessories given in the technical appendix must be followed.

Width/Length/Height of lowest version	mm
max. current / max. cond. cross-section	A/mm ²
Max. clamping range	mm ²

Technical data











Rated data	
Rated voltage	V
Rated current	A
Rated cross-section	mm ²
Rated impulse withstand voltage / Pollution severity Gauge to IEC 60947-1 / Flammability class UL94	
Approvals	
Clamped conductors (H05V/H07V)	
Solid / stranded	mm ²
Flexible / Flexible with ferrule	mm ²
Twin wire-end ferrule	mm ²
Stripping length / Blade size	mm/-

Note

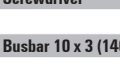
Ordering data

Version	
	Dark beige Wemid
Note	

Accessories

Pluggable cross-connection	
	2-pole
	3-pole
	4-pole
	10-pole
End plate / Partition plate	
	Dark beige Wemid
Support bracket for 10 x 3 (required every 20 cm)	
	Blue Wemid For a vertical installation position
End bracket	
	Dark beige Wemid
Screwdriver	
	Standard
Busbar 10 x 3 (140 A)	
	OK, Busbar up to OK, TS35 = 25.5 mm
Clamping yoke for power supply to 10 x 3 busbars	
	Rigid / flexible 0.5 - 6 / 4 mm ² Rigid / flexible 6 - 16 mm ² Flexible 16 - 35 mm ²

Identification systems	(see assortment in catalogue 7)
	Marking tags
Note	

PDL 4 S/N

4 mm²

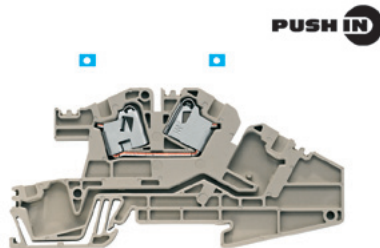

5.1 x 100 x 48.5	
36 / 4	
0.08...4	

IEC 60947-7-1

IEC	UL	CSA
400		
32		
4		
6 kV / 3		
A3 / V-0		

Rated connection			
0.5...4	/	1.5...4	
0.5...4	/	0.5...4	
0.5...1.5			
12 / 3.0 x 0.5 mm			

Type	Qty.	Order No.
PDL 4 S/N	50	1847620000

Type	current	Qty.	Order No.
ZQV 2.5/2	24 A	60	1608860000
ZQV 2.5/3	24 A	60	1608870000
ZQV 2.5/4	24 A	60	1608880000
ZQV 2.5/10	24 A	20	1608940000
Width			
PAP PDL4S	1.5 mm	20	1837070000
PHP PDL	3 mm	20	1837090000
PHP PDL SO	3 mm	20	1837080000
ZEW 35/2	8 mm	20	8630740000
SDIS 0.4X2.5X75		1	9008370000
SSCH 10X3X1000 CU/SN	10 mm	1	0348900000
ZF 4 S BL	6.1 mm	50	1814660000
ZB 16 ZKSC	10 mm	50	0316600000
ZB 35/M6X16	14 mm	20	0266500000

DEK 5/5

PDL 4 S/L/L/PE

4 mm²

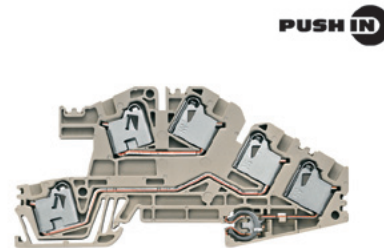

5.1 x 100 x 48.5	
36 / 4	
0.08...4	

IEC 60947-7-1 (-7-2)

IEC	UL	CSA
400		
32		
4		
6 kV / 3		
A3 / V-0		

Rated connection			
0.5...4	/	1.5...4	
0.5...4	/	0.5...4	
0.5...1.5			
12 / 3.0 x 0.5 mm			

Type	Qty.	Order No.
PDL 4 S/L/L/PE	50	1837040000

Type	current	Qty.	Order No.
ZQV 2.5/2	24 A	60	1608860000
ZQV 2.5/3	24 A	60	1608870000
ZQV 2.5/4	24 A	60	1608880000
ZQV 2.5/10	24 A	20	1608940000
Width			
PAP PDL4S	1.5 mm	20	1837070000
PHP PDL	3 mm	20	1837090000
PHP PDL SO	3 mm	20	1837080000
ZEW 35/2	8 mm	20	8630740000
SDIS 0.4X2.5X75		1	9008370000
SSCH 10X3X1000 CU/SN	10 mm	1	0348900000
ZF 4 S BL	6.1 mm	50	1814660000
ZB 16 ZKSC	10 mm	50	0316600000
ZB 35/M6X16	14 mm	20	0266500000

DEK 5/5

Modular distribution terminals

PDL 4 NT/L/PE

4 mm²

PDL 4 NT/L

4 mm²

In hazardous area applications, the installation instructions and the rated data specifications for accessories given in the technical appendix must be followed.

Width/Length/Height of lowest version	mm
max. current / max. cond. cross-section	A/mm ²
Max. clamping range	mm ²

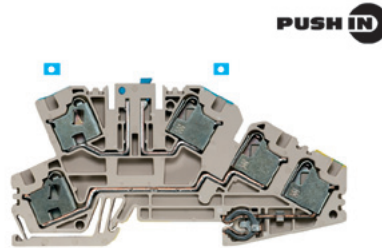

5.1 x 100 x 49.1	
/ 4	
0.08...4	

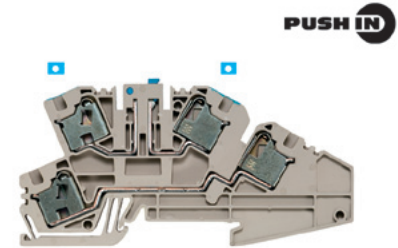

5.1 x 100 x 49.1	
/ 4	
0.08...4	

Technical data

Rated data	
Rated voltage	V
Rated current	A
Rated cross-section	mm ²
Rated impulse withstand voltage / Pollution severity	
Gauge to IEC 60947-1 / Flammability class UL94	
Approvals	
Clamped conductors (H05V/H07V)	
Solid / stranded	mm ²
Flexible / Flexible with ferrule	mm ²
Twin wire-end ferrule	mm ²
Stripping length / Blade size	mm/-
Note	

IEC	UL	CSA
400	300 (D)	300 (B)
20	10 (D)	20 (B)
4	AWG 28...10	AWG 28...10
6 kV / 3		
A3 / V-0		
Rated connection		
0.5...4 / 1.5...4		
0.5...4 / 0.5...4		
0.5...1.5		
12 / 3.0 x 0.5 mm		
Note		

IEC	UL	CSA
400	150 (C)	300 (B)
20	17 (C)	20 (B)
4	AWG 28...10	AWG 28...10
6 kV / 3		
A3 / V-0		
Rated connection		
0.5...4 / 1.5...4		
0.5...4 / 0.5...4		
0.5...1.5		
12 / 3.0 x 0.5 mm		
Note		

Ordering data

Version	Dark beige Wemid
Note	

Type	Qty.	Order No.
PDL 4/NT/L/PE	50	1882620000

Type	Qty.	Order No.
PDL 4/NT/L	50	1882600000

Accessories

Pluggable cross-connection	
	2-pole
	3-pole
	4-pole
	10-pole
End plate / Partition plate	
	Dark beige Wemid
End bracket	
	Dark beige Wemid
Screwdriver	
	Standard

Type	current	Qty.	Order No.
ZQV 2.5/2	24 A	60	1608860000
ZQV 2.5/3	24 A	60	1608870000
ZQV 2.5/4	24 A	60	1608880000
ZQV 2.5/10	24 A	20	1608940000
Width			
PAP PDL4	1.5 mm	20	1883210000
ZEW 35/2	8 mm	20	8630740000
SDIS 0.4X2.5X75		1	9008370000

Type	current	Qty.	Order No.
ZQV 2.5/2	24 A	60	1608860000
ZQV 2.5/3	24 A	60	1608870000
ZQV 2.5/4	24 A	60	1608880000
ZQV 2.5/10	24 A	20	1608940000
Width			
PAP PDL4	1.5 mm	20	1883210000
ZEW 35/2	8 mm	20	8630740000
SDIS 0.4X2.5X75		1	9008370000

Identification systems	(see assortment in catalogue 7)
	Marking tags
Note	

DEK 5/5
Note

DEK 5/5
Note

Actuator and installation terminals

Modular distribution terminals

In hazardous area applications, the installation instructions and the rated data specifications for accessories given in the technical appendix must be followed.

Width/Length/Height of lowest version	mm
max. current / max. cond. cross-section	A/mm ²
Max. clamping range	mm ²

Technical data

Rated data	
Rated voltage	V
Rated current	A
Rated cross-section	mm ²
Rated impulse withstand voltage / Pollution severity	
Gauge to IEC 60947-1 / Flammability class UL94	
Approvals	
Clamped conductors (H05V/H07V)	
Solid / stranded	mm ²
Flexible / Flexible with ferrule	mm ²
Twin wire-end ferrule	mm ²
Stripping length / Blade size	mm/-
Note	

Ordering data

Version	Dark beige Wemid
Note	

Accessories

Pluggable cross-connection	
	2-pole
	3-pole
	4-pole
	10-pole
End plate / Partition plate	
	Dark beige Wemid
End bracket	
	Dark beige Wemid
Screwdriver	
	Standard

Identification systems	(see assortment in catalogue 7)
	Marking tags
Note	

PDL 4 N/L/PE

4 mm²

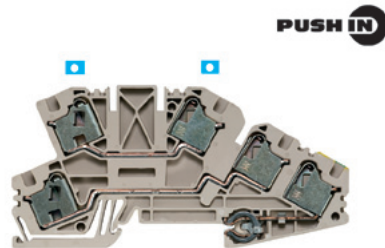

5.1 x 100 x 49.1	
/ 4	
0.08...4	

IEC	UL	CSA
400	300 (D)	300 (B)
32	10 (D)	20 (B)
4	AWG 28...10	AWG 28...10
6 kV / 3		
A3 / V-0		
Rated connection		
0.5...4 / 1.5...4		
0.5...4 / 0.5...4		
0.5...1.5		
12 / 3.0 x 0.5 mm		

Type	Qty.	Order No.
PDL 4/N/L/PE	50	1899180000

Type	current	Qty.	Order No.
ZQV 2.5/2	24 A	60	1608860000
ZQV 2.5/3	24 A	60	1608870000
ZQV 2.5/4	24 A	60	1608880000
ZQV 2.5/10	24 A	20	1608940000
Width			
PAP PDL4	1.5 mm	20	1883210000
ZEW 35/2	8 mm	20	8630740000
SDIS 0.4X2.5X75		1	9008370000

Identification systems	(see assortment in catalogue 7)
	Marking tags
Note	

PDL 4 L/L/PE

4 mm²

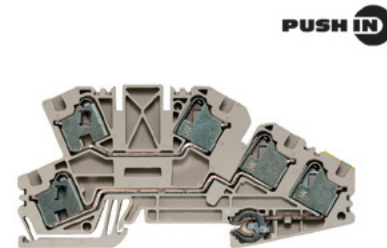

5.1 x 100 x 49.5	
/ 4	
0.08...4	

IEC	UL	CSA
400	300 (D)	300 (B)
32	10 (D)	20 (B)
4	AWG 28...10	AWG 28...10
6 kV / 3		
A3 / V-0		
Rated connection		
0.5...4 / 1.5...4		
0.5...4 / 0.5...4		
0.5...1.5		
12 / 3.0 x 0.5 mm		

Type	Qty.	Order No.
PDL 4/L/L/PE	50	1882610000

Type	current	Qty.	Order No.
ZQV 2.5/2	24 A	60	1608860000
ZQV 2.5/3	24 A	60	1608870000
ZQV 2.5/4	24 A	60	1608880000
ZQV 2.5/10	24 A	20	1608940000
Width			
PAP PDL4	1.5 mm	20	1883210000
ZEW 35/2	8 mm	20	8630740000
SDIS 0.4X2.5X75		1	9008370000

Identification systems	(see assortment in catalogue 7)
	Marking tags
Note	

PDL 4 L/L

4 mm²



5.1 x 100 x 49.5
/ 4
0.08...4

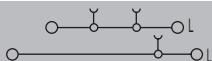

IEC	UL	CSA
400	150 (C)	300 (B)
32	17 (C)	20 (B)
4	AWG 28...10	AWG 28...10
6 kV / 3		
A3 / V-0		



Rated connection

0.5...4 / 1.5...4

0.5...4 / 0.5...4

0.5...1.5

12 / 3.0 x 0.5 mm

Type	Qty.	Order No.
PDL 4/L/L	50	1882590000

Type	current	Qty.	Order No.
ZQV 2.5/2	24 A	60	1608860000
ZQV 2.5/3	24 A	60	1608870000
ZQV 2.5/4	24 A	60	1608880000
ZQV 2.5/10	24 A	20	1608940000
Width			
PAP PDL4	1.5 mm	20	1883210000
ZEW 35/2	8 mm	20	8630740000
SDIS 0.4X2.5X75		1	9008370000

DEK 5/5

The PRV and PPV marshalling- and potential distribution terminal blocks



The affordable and space-saving method for signal distribution and routing

Today's control systems are becoming increasingly more complex with higher and higher demands for the monitoring and capturing of operational data. These demands have resulted in a relentless growth in the number of field measuring devices. These trends pose new challenges to engineers.

On one hand, the additional signals for the automation need to be connected and processed. On the other hand this means using up more space and increased costs.

These challenges can be simply dealt with using Weidmüller's new marshalling and distribution terminals. The PRV, with its PUSH IN wire connection, is the most compact marshalling terminal worldwide.

Amazing space saving

In comparison to conventional multi-tier terminals, the new marshalling- and potential distribution terminal blocks have a higher contact density.

Up to 50 % less space is used in the electrical cabinet with the optimised PRV design.

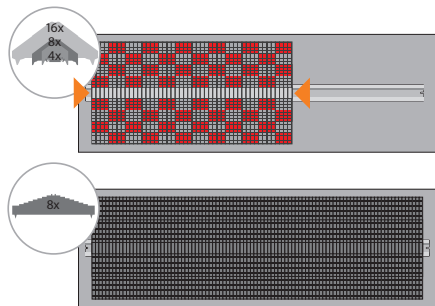

Optimal orientation

Colour coding on the terminals provides for easy assignment of signals and clarity during extension work or maintenance.



product design award

2012

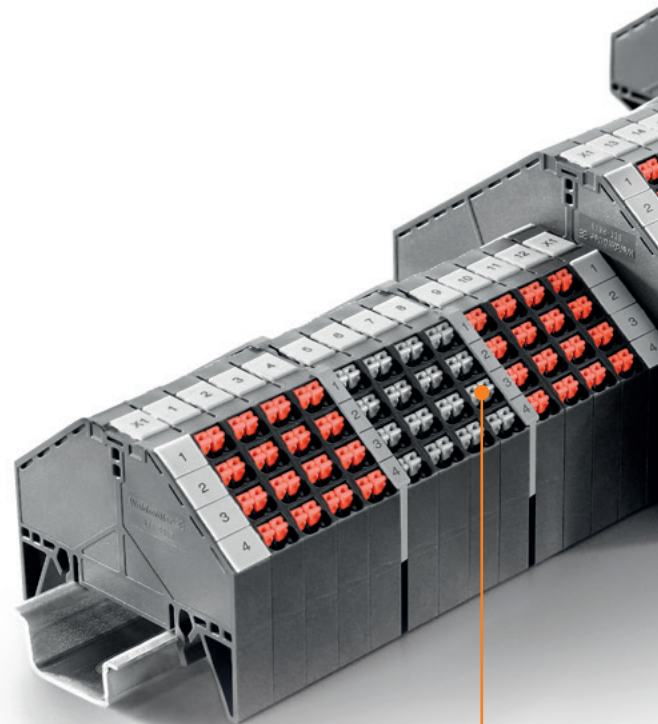

Compact and redundant

The PUSH IN double connection offers redundant connection, taking up minimal space.

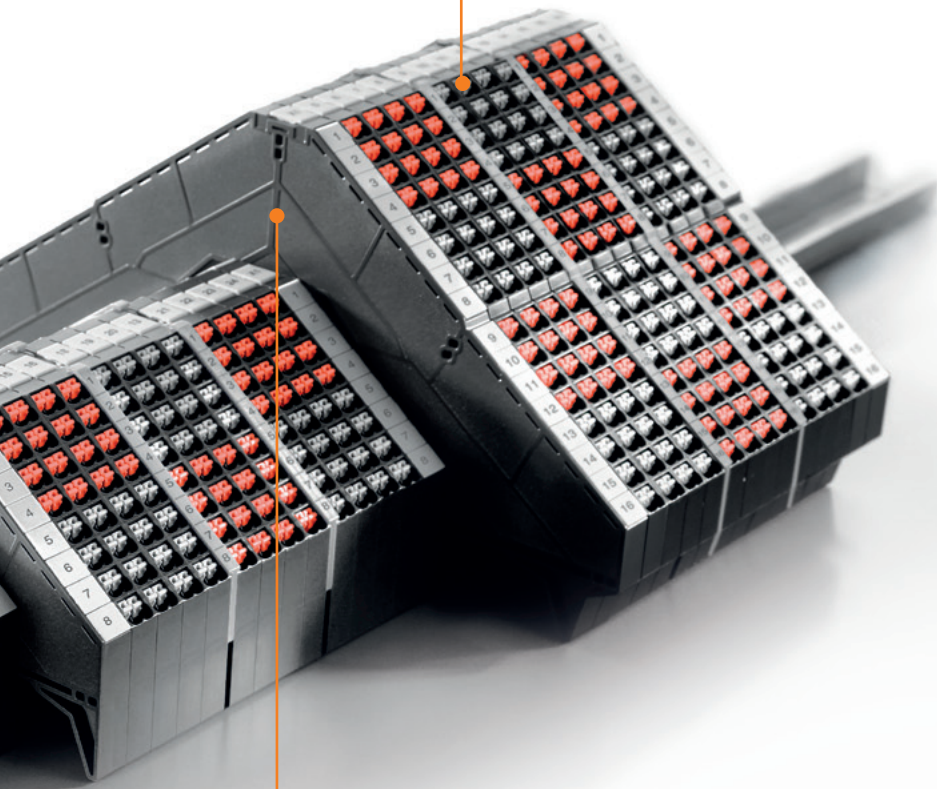
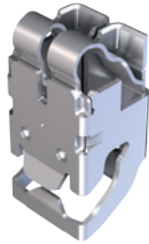

Low contact resistance

The busbar's unique V-shape allows for varying expansion of materials and ensures low contact resistances.



PPV power distribution terminal

For simple and safe potential distribution, the four-level and eight-level marshalling terminals are also available as potential distribution terminals.

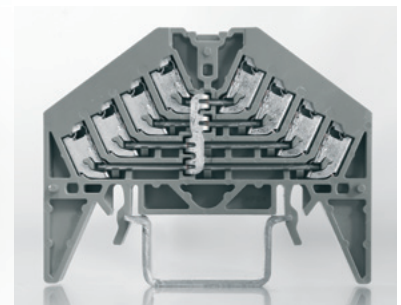

PUSH IN

Simple – The stripped wire is simply inserted into the terminal point, and a reliable, vibration proof, gas-tight connection is guaranteed.

Safe – The best designed connection method features high wire extraction forces and vibration resistance.



Marshalling- and potential distribution terminal blocks

PRV

In hazardous area applications, the installation instructions and the rated data specifications for accessories given in the technical appendix must be followed.

Width/Length/Height of lowest version	mm
max. current / max. cond. cross-section	A/mm ²
Max. clamping range	mm ²

Technical data

Rated data	
Rated voltage	V
Rated current	A
Rated cross-section	mm ²
Rated impulse withstand voltage / Pollution severity	
Gauge to IEC 60947-1 / Flammability class UL94	
Approvals	
Clamped conductors (H05V/H07V)	
Solid / stranded	mm ²
Flexible / Flexible with ferrule	mm ²
Twin wire-end ferrule	mm ²
Stripping length / Blade size	mm/-
Note	

Ordering data

Version	
	Black for TS 35x15
	Blue for TS 35x15
	Black for TS 35x7.5
	Blue for TS 35x7.5
Note	

Accessories

End plate	
	black
	blue
	grey
Marker holder	
	Black for TS 35x15
	Blue for TS 35x15
	Black for TS 35x7.5
	Blue for TS 35x7.5
Partition plate	
	Unprinted
	Printed 0...3 or 0...7 or 0...15
	Printed 1...4 or 1...8 or 1...16
	Printed A...D or A...H or A...P
End bracket	
	black
Screwdriver	
	Standard
Pluggable cross-connection	
	2-pole
Identification systems	
	(see assortment in catalogue 7)
	Marking tags
Note	

PRV 4 RT

1.5 mm²

NEW



9.2 x 70 x	
13 / 1.5	
0.2...1.5	

IEC	UL	CSA
250	300 (D)	300 (D)
10	10 (D)	10 (D)
1.5	AWG 26...16	AWG 26...16
4 kV / 3 / V-0		
Rated connection		
0.2...1.5 / 0.2...1.5		
0.2...1.5 / 0.2...1.5		
10 / 0.6 x 3.5 mm		
Note		

Type	Qty.	Order No.
PRV 4 SW 35X15 RT	20	1173810000
PRV 4 BL 35X15 RT	20	1267890000
PRV 4 SW 35X7.5 RT	20	1173830000
PRV 4 BL 35X7.5 RT	20	1267900000
RT = red actuators		

Type	Width	Qty.	Order No.
PAP PRV/PPV4 SW	3 mm	10	1173750000
PAP PRV/PPV4 BL	3 mm	10	1268010000
PAP PRV/PPV4 GR	3 mm	10	1211450000
BZT PRV4 SW 35X15	10.2 mm	20	1173590000
BZT PRV4 BL 35X15	10.2 mm	20	1267980000
BZT PRV4 SW 35X7.5	10.2 mm	20	1173600000
BZT PRV4 BL 35X7.5	10.2 mm	20	1267990000
TW PRV4	2 mm	10	1173700000
TW PRV4 0-3	2 mm	10	1230060000
TW PRV4 1-4	2 mm	10	1230050000
TW PRV4 A-D	2 mm	10	1230070000
ZEW 35/2 SW	8 mm	20	1162610000
SDIS SL 0.6X3.5X100		1	1274660000
current			
SRC-I QV P		10	8870840000

WS 7.8/9.2	
Note	

PRV 4 WS

1.5 mm²

NEW



9.2 x 70 x	
13 / 1.5	
0.2...1.5	

IEC	UL	CSA
250	300 (D)	300 (D)
10	10 (D)	10 (D)
1.5	AWG 26...16	AWG 26...16
4 kV / 3 / V-0		
Rated connection		
0.2...1.5 / 0.2...1.5		
0.2...1.5 / 0.2...1.5		
10 / 0.6 x 3.5 mm		
Note		

Type	Qty.	Order No.
PRV 4 SW 35X15 WS	20	1173820000
PRV 4 BL 35X15 WS	20	1173920000
PRV 4 SW 35X7.5 WS	20	1173840000
PRV 4 BL 35X7.5 WS	20	1173930000
WS = white actuators		

Type	Width	Qty.	Order No.
PAP PRV/PPV4 SW	3 mm	10	1173750000
PAP PRV/PPV4 BL	3 mm	10	1268010000
PAP PRV/PPV4 GR	3 mm	10	1211450000
BZT PRV4 SW 35X15	10.2 mm	20	1173590000
BZT PRV4 BL 35X15	10.2 mm	20	1267980000
BZT PRV4 SW 35X7.5	10.2 mm	20	1173600000
BZT PRV4 BL 35X7.5	10.2 mm	20	1267990000
TW PRV4	2 mm	10	1173700000
TW PRV4 0-3	2 mm	10	1230060000
TW PRV4 1-4	2 mm	10	1230050000
TW PRV4 A-D	2 mm	10	1230070000
ZEW 35/2 SW	8 mm	20	1162610000
SDIS SL 0.6X3.5X100		1	1274660000
current			
SRC-I QV P		10	8870840000

WS 7.8/9.2	
Note	

PRV

In hazardous area applications, the installation instructions and the rated data specifications for accessories given in the technical appendix must be followed.

Width/Length/Height of lowest version	mm
max. current / max. cond. cross-section	A/mm ²
Max. clamping range	mm ²

Technical data

Rated data	
Rated voltage	V
Rated current	A
Rated cross-section	mm ²
Rated impulse withstand voltage / Pollution severity	
Gauge to IEC 60947-1 / Flammability class UL94	
Approvals	
Clamped conductors (H05V/H07V)	
Solid / stranded	mm ²
Flexible / Flexible with ferrule	mm ²
Twin wire-end ferrule	mm ²
Stripping length / Blade size	mm/-
Note	

Ordering data

Version	
	Black for TS 35x15
	Blue for TS 35x15
	Black for TS 35x7.5
	Blue for TS 35x7.5
Note	

Accessories

End plate	
	black
	blue
	grey
Marker holder	
	Black for TS 35x15
	Blue for TS 35x15
	Black for TS 35x7.5
	Blue for TS 35x7.5
Partition plate	
	Unprinted
	Printed 0...3 or 0...7 or 0...15
	Printed 1...4 or 1...8 or 1...16
	Printed A...D or A...H or A...P
End bracket	
	black
Screwdriver	
	Standard
Pluggable cross-connection	
	2-pole
Identification systems (see assortment in catalogue 7)	
	Marking tags
Note	

PRV 8 RT/WS

1.5 mm²

NEW

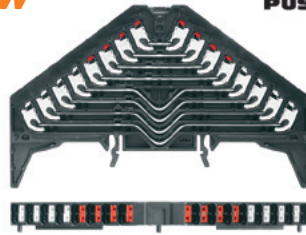

9.2 x 120 x	
10 / 1.5	
0.2...1.5	

IEC	UL	CSA
250	300 (D)	300 (D)
8	10 (D)	10 (D)
1.5	AWG 26...16	AWG 26...16
4 kV / 3 / V-0		
Rated connection		
0.2...1.5 / 0.2...1.5		
0.2...1.5 / 0.2...1.5		
10 / 0.6 x 3.5 mm		

Type	Qty.	Order No.
PRV 8 SW 35X15 RT/WS	20	1173740000
PRV 8 BL 35X15 RT/WS	20	1267830000
PRV 8 SW 35X7.5 RT/WS	20	1173790000
PRV 8 BL 35X7.5 RT/WS	20	1267840000

RT = red actuators
WS = white actuators

Type	Width	Qty.	Order No.
PAP PRV/PPV8 SW	3 mm	10	1173720000
PAP PRV/PPV8 BL	3 mm	10	1268000000
PAP PRV/PPV8 GR	3 mm	10	1211460000
BZT PRV8 SW 35X15	10.2 mm	20	1173570000
BZT PRV8 BL 35X15	10.2 mm	20	1267950000
BZT PRV8 SW 35X7.5	10.2 mm	20	1173580000
BZT PRV8 BL 35X7.5	10.2 mm	20	1267970000
TW PRV8	2 mm	10	1173670000
TW PRV8 0-7	2 mm	10	1230090000
TW PRV8 1-8	2 mm	10	1230080000
TW PRV8 A-H	2 mm	10	1230110000
ZEW 35/2 SW	8 mm	20	1162610000
SDIS SL 0.6X3.5X100		1	1274660000
current			
SRC-I QV P		10	8870840000
Identification systems			
WS 7.8/9.2			
Note			

PRV 8 WS/RT

1.5 mm²

NEW



9.2 x 120 x	
10 / 1.5	
0.2...1.5	

IEC	UL	CSA
250	300 (D)	300 (D)
8	10 (D)	10 (D)
1.5	AWG 26...16	AWG 26...16
4 kV / 3 / V-0		
Rated connection		
0.2...1.5 / 0.2...1.5		
0.2...1.5 / 0.2...1.5		
10 / 0.6 x 3.5 mm		

Type	Qty.	Order No.
PRV 8 SW 35X15 WS/RT	20	1173780000
PRV 8 BL 35X15 WS/RT	20	1173900000
PRV 8 SW 35X7.5 WS/RT	20	1173800000
PRV 8 BL 35X7.5 WS/RT	20	1173910000

RT = red actuators
WS = white actuators

Type	Width	Qty.	Order No.
PAP PRV/PPV8 SW	3 mm	10	1173720000
PAP PRV/PPV8 BL	3 mm	10	1268000000
PAP PRV/PPV8 GR	3 mm	10	1211460000
BZT PRV8 SW 35X15	10.2 mm	20	1173570000
BZT PRV8 BL 35X15	10.2 mm	20	1267950000
BZT PRV8 SW 35X7.5	10.2 mm	20	1173580000
BZT PRV8 BL 35X7.5	10.2 mm	20	1267970000
TW PRV8	2 mm	10	1173670000
TW PRV8 0-7	2 mm	10	1230090000
TW PRV8 1-8	2 mm	10	1230080000
TW PRV8 A-H	2 mm	10	1230110000
ZEW 35/2 SW	8 mm	20	1162610000
SDIS SL 0.6X3.5X100		1	1274660000
current			
SRC-I QV P		10	8870840000
Identification systems			
WS 7.8/9.2			
Note			

Marshalling- and potential distribution terminal blocks

PRV

In hazardous area applications, the installation instructions and the rated data specifications for accessories given in the technical appendix must be followed.

Width/Length/Height of lowest version	mm
max. current / max. cond. cross-section	A/mm ²
Max. clamping range	mm ²

Technical data

Rated data	
Rated voltage	V
Rated current	A
Rated cross-section	mm ²
Rated impulse withstand voltage / Pollution severity	
Gauge to IEC 60947-1 / Flammability class UL94	
Approvals	
Clamped conductors (H05V/H07V)	
Solid / stranded	mm ²
Flexible / Flexible with ferrule	mm ²
Twin wire-end ferrule	mm ²
Stripping length / Blade size	mm/-
Note	

Ordering data

Version	
	Black for TS 35x15
	Blue for TS 35x15
	Black for TS 35x7.5
	Blue for TS 35x7.5
Note	

Accessories

End plate	
	black
	blue
	grey
Marker holder	
	Black for TS 35x15
	Blue for TS 35x15
	Black for TS 35x7.5
	Blue for TS 35x7.5
Partition plate	
	Unprinted
	Printed 0...3 or 0...7 or 0...15
	Printed 1...4 or 1...8 or 1...16
	Printed A...D or A...H or A...P
End bracket	
	black
Screwdriver	
	Standard
Pluggable cross-connection	
	2-pole
Identification systems	
	(see assortment in catalogue 7)
	Marking tags
Note	

PRV 16 RT/WS

1.5 mm²

NEW

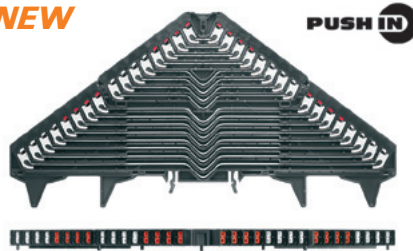

9.2 x 225 x	
11 / 1.5	
0.2...1.5	

IEC 60947-7-1, DIN EN 60079

IEC	UL	CSA
250	300 (D)	300 (D)
6	1 (D)	1 (D)
1.5	AWG 26...16	AWG 26...16
4 kV / 3 / V-0		
Rated connection		
0.2...1.5 / 0.2...1.5		
0.2...1.5 / 0.2...1.5		
10 / 0.6 x 3.5 mm		

Type	Qty.	Order No.
PRV 16 SW 35X15 RT/WS	20	1173620000
PRV 16 BL 35X15 RT/WS	20	1267790000
PRV 16 SW 35X7.5 RT/WS	20	1173680000
PRV 16 BL 35X7.5 RT/WS	20	1267810000

RT = red actuators
WS = white actuators

Type	Width	Qty.	Order No.
BZT PRV16 SW 35X15	10.2 mm	20	1173540000
BZT PRV16 BL 35X15	10.2 mm	20	1267930000
BZT PRV16 SW 35X7.5	10.2 mm	20	1173550000
BZT PRV16 BL 35X7.5	10.2 mm	20	1267940000
TW PRV16	2 mm	10	1173630000
TW PRV16 0-15	2 mm	10	1230130000
TW PRV16 1-16	2 mm	10	1230120000
TW PRV16 A-P	2 mm	10	1230140000
WEW 35/1 SW	12 mm	50	1162600000
SDIS SL 0.6X3.5X100		1	1274660000
		current	
SRC-I QV P		10	8870840000

WS 7.8/9.2

PRV 16 WS/RT

1.5 mm²

NEW

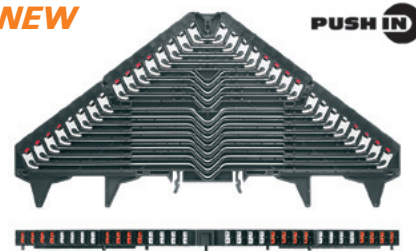

9.2 x 225 x	
11 / 1.5	
0.2...1.5	

IEC 60947-7-1, DIN EN 60079

IEC	UL	CSA
250	300 (D)	300 (D)
6	1 (D)	1 (D)
1.5	AWG 26...16	AWG 26...16
4 kV / 3 / V-0		
Rated connection		
0.2...1.5 / 0.2...1.5		
0.2...1.5 / 0.2...1.5		
10 / 0.6 x 3.5 mm		

Type	Qty.	Order No.
PRV 16 SW 35X15 WS/RT	20	1173650000
PRV 16 BL 35X15 WS/RT	20	1267800000
PRV 16 SW 35X7.5 WS/RT	20	1173710000
PRV 16 BL 35X7.5 WS/RT	20	1267820000

RT = red actuators
WS = white actuators

Type	Width	Qty.	Order No.
BZT PRV16 SW 35X15	10.2 mm	20	1173540000
BZT PRV16 BL 35X15	10.2 mm	20	1267930000
BZT PRV16 SW 35X7.5	10.2 mm	20	1173550000
BZT PRV16 BL 35X7.5	10.2 mm	20	1267940000
TW PRV16	2 mm	10	1173630000
TW PRV16 0-15	2 mm	10	1230130000
TW PRV16 1-16	2 mm	10	1230120000
TW PRV16 A-P	2 mm	10	1230140000
WEW 35/1 SW	12 mm	50	1162600000
SDIS SL 0.6X3.5X100		1	1274660000
		current	
SRC-I QV P		10	8870840000

WS 7.8/9.2

PPV

In hazardous area applications, the installation instructions and the rated data specifications for accessories given in the technical appendix must be followed.

Width/Length/Height of lowest version	mm
max. current / max. cond. cross-section	A/mm ²
Max. clamping range	mm ²

Technical data

Rated data	
Rated voltage	V
Rated current	A
Rated cross-section	mm ²
Rated impulse withstand voltage / Pollution severity	
Gauge to IEC 60947-1 / Flammability class UL94	
Approvals	
Clamped conductors (H05V/H07V)	
Solid / stranded	mm ²
Flexible / Flexible with ferrule	mm ²
Twin wire-end ferrule	mm ²
Stripping length / Blade size	mm/-
Note	

Ordering data

Version	
	Blue for TS 35x15
	Grey for TS 35x15
	Blue for TS 35x7.5
	Grey for TS 35x7.5
Note	

Accessories

End plate	
	black
	blue
	grey
Marker holder	
	Black for TS 35x15
	Blue for TS 35x15
	Black for TS 35x7.5
	Blue for TS 35x7.5
Partition plate	
	Unprinted
	Printed 0...3 or 0...7 or 0...15
	Printed 1...4 or 1...8 or 1...16
	Printed A...D or A...H or A...P
End bracket	
	black
Screwdriver	
	Standard
Pluggable cross-connection	
	2-pole
Identification systems	
	(see assortment in catalogue 7)
	Marking tags
Note	

PPV 4

1.5 mm²

NEW

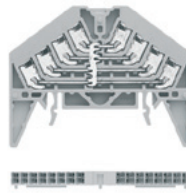

9.2 x 70 x	
/ 1.5	
0.2...1.5	

IEC 60947-7-1, DIN EN 60079

IEC	UL	CSA
250	300 (D)	300 (D)
17.5	10 (D)	10 (D)
1.5	AWG 26...16	AWG 26...16
4 kV / 3 / V-0		
Rated connection		
0.2...1.5 / 0.2...1.5		
0.2...1.5 / 0.2...1.5		
10 / 0.6 x 3.5 mm		

Type	Qty.	Order No.
PPV 4 BL 35X15 DGR	20	1267910000
PPV 4 GR 35X15 DGR	20	1173880000
PPV 4 BL 35X7.5 DGR	20	1267920000
PPV 4 GR 35X7.5 DGR	20	1173890000

DRG = dark grey actuators

Type	Width	Qty.	Order No.
PAP PRV/PPV4 SW	3 mm	10	1173750000
PAP PRV/PPV4 BL	3 mm	10	1268010000
PAP PRV/PPV4 GR	3 mm	10	1211450000
BZT PRV4 SW 35X15	10.2 mm	20	1173590000
BZT PRV4 BL 35X15	10.2 mm	20	1267980000
BZT PRV4 SW 35X7.5	10.2 mm	20	1173600000
BZT PRV4 BL 35X7.5	10.2 mm	20	1267990000
TW PRV4	2 mm	10	1173700000
TW PRV4 0-3	2 mm	10	1230060000
TW PRV4 1-4	2 mm	10	1230050000
TW PRV4 A-D	2 mm	10	1230070000
ZEW 35/2 SW	8 mm	20	1162610000
SDIS SL 0.6X3.5X100		1	1274660000
current			
SRC-I QV P		10	8870840000

WS 7.8/9.2

PPV 8

1.5 mm²

NEW

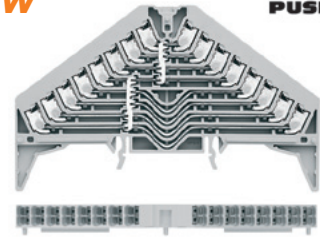

9.2 x 120 x	
/ 1.5	
0.2...1.5	

IEC 60947-7-1, DIN EN 60079

IEC	UL	CSA
250	300 (D)	300 (D)
17.5	10 (D)	10 (D)
1.5	AWG 26...16	AWG 26...16
4 kV / 3 / V-0		
Rated connection		
0.2...1.5 / 0.2...1.5		
0.2...1.5 / 0.2...1.5		
10 / 0.6 x 3.5 mm		

Type	Qty.	Order No.
PPV 8 BL 35X15 DGR	20	1267870000
PPV 8 GR 35X15 DGR	20	1173850000
PPV 8 BL 35X7.5 DGR	20	1267880000
PPV 8 GR 35X7.5 DGR	20	1173870000

DRG = dark grey actuators

Type	Width	Qty.	Order No.
PAP PRV/PPV8 SW	3 mm	10	1173720000
PAP PRV/PPV8 BL	3 mm	10	1268000000
PAP PRV/PPV8 GR	3 mm	10	1211460000
BZT PRV8 SW 35X15	10.2 mm	20	1173570000
BZT PRV8 BL 35X15	10.2 mm	20	1267950000
BZT PRV8 SW 35X7.5	10.2 mm	20	1173580000
BZT PRV8 BL 35X7.5	10.2 mm	20	1267970000
TW PRV8	2 mm	10	1173670000
TW PRV8 0-7	2 mm	10	1230090000
TW PRV8 1-8	2 mm	10	1230080000
TW PRV8 A-H	2 mm	10	1230110000
ZEW 35/2 SW	8 mm	20	1162610000
SDIS SL 0.6X3.5X100		1	1274660000
current			
SRC-I QV P		10	8870840000

WS 7.8/9.2

16 level terminals with
Pushers in white and red
PRV 16 SW 35X7.5 WS/RT

Marker
WS7.8/9.2 PLUS MC GR

16 level terminals with
Pushers in red and white
PRV 16 SW 35X7.5 RT/WS

End bracket in black
WEW 35/1 SW

Mounting rail
Type TS35, 7.5 mm high

Printed partition plate
TW PRV 1-16

Marker carrier BZT PRV 16 SW 35X7.5
Marker WS7.8/9.2 PLUS MC GR

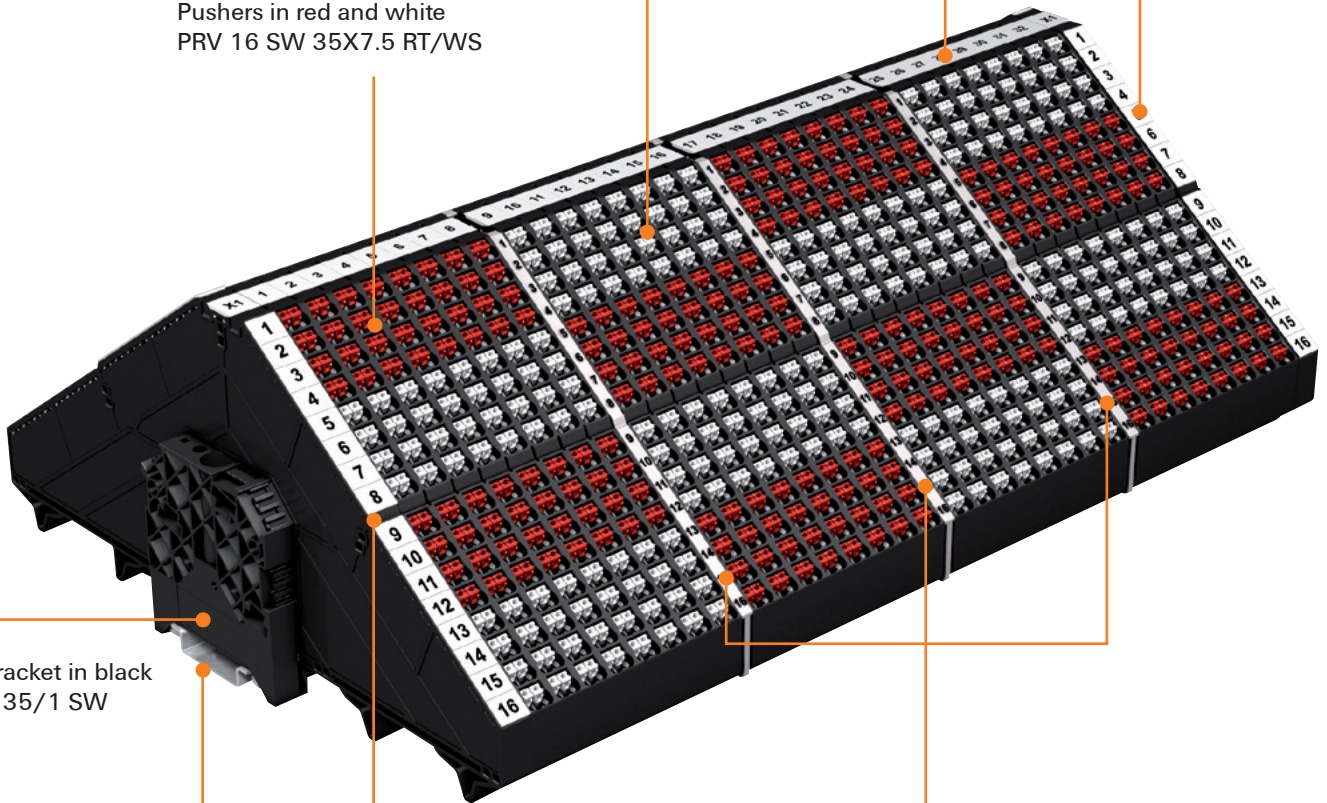

Technical data

Partition plate	Type	Order No.
unprinted	TW PRV4	1173700000
unprinted	TW PRV8	1173670000
unprinted	TW PRV16	1173630000
printed 0...3	TW PRV4 0-3	1230060000
printed 0...7	TW PRV8 0-7	1230090000
printed 0...15	TW PRV16 0-15	1230130000
printed 1...4	TW PRV4 1-4	1230050000
printed 1...8	TW PRV8 1-8	1230080000
printed 1...16	TW PRV16 1-16	1230120000
printed A...D	TW PRV4 A-D	1230070000
printed A...H	TW PRV8 A-H	1230110000
printed A...P	TW PRV16 A-P	1230140000

Extra functions

Introduction

The accessories for our other ranges of modular terminals can also be used with the P-Series in order to reduce the number of variations. The use of accessories enables users to adapt and mould the terminals, to perfectly match the needs of their application.

All Weidmüller accessories are built to the same high-quality standards as the terminals themselves.

Retaining and end plates

Page B.46

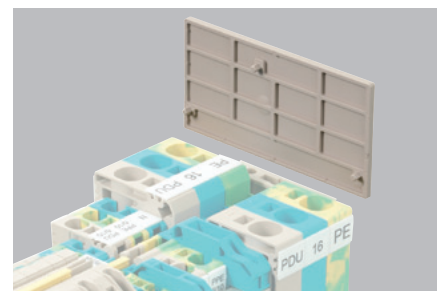

End plates cover the open side of the terminals. This ensures touch protection for fingers and hands. Retaining plates, which for the P-Series also function as end plates, must be positioned every 200 mm when using the 10 x 3 busbar.

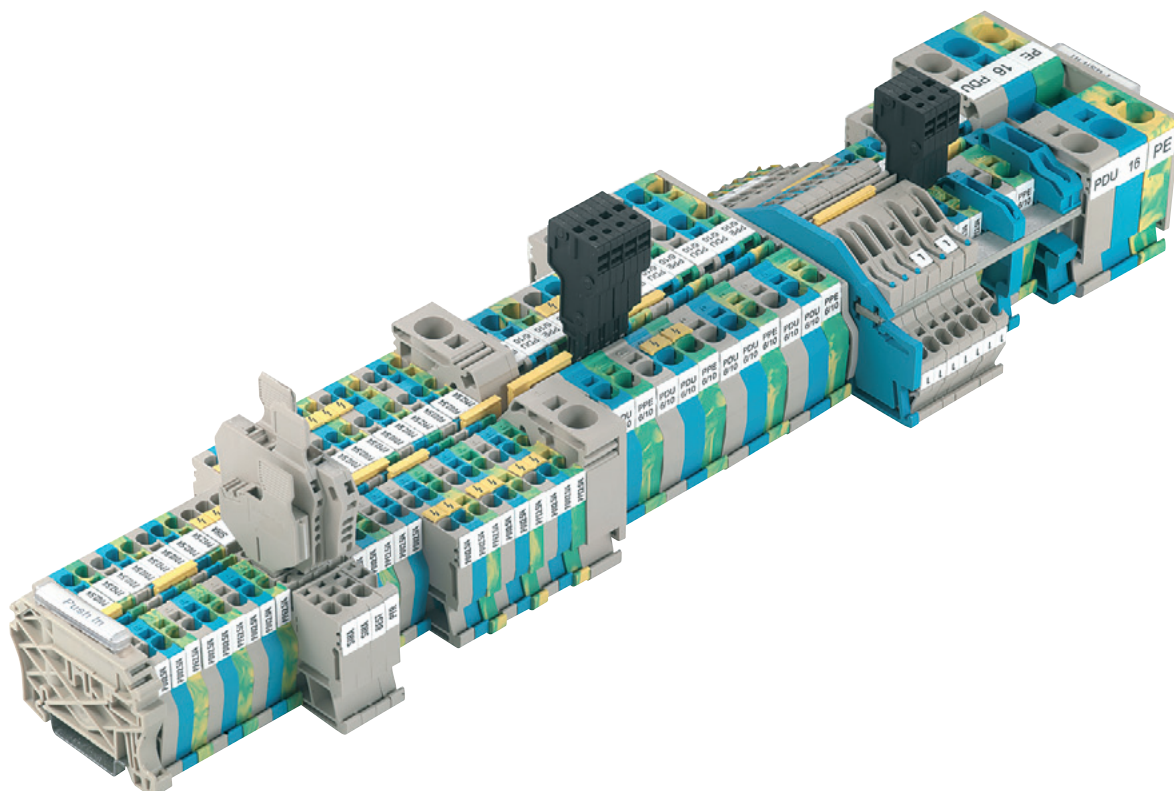

Fastening

Chapter F

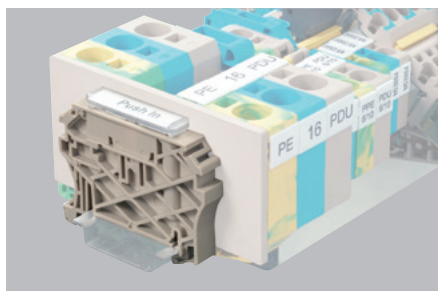

An end bracket is fitted on the mounting rail to the right and left of the terminals to ensure that they sit firmly in position. The marking surface of the end bracket can also be used for group marking. Details of the wide range of Weidmüller end brackets and mounting rails are given in **chapter F**.

Electrical supply

Page B.47

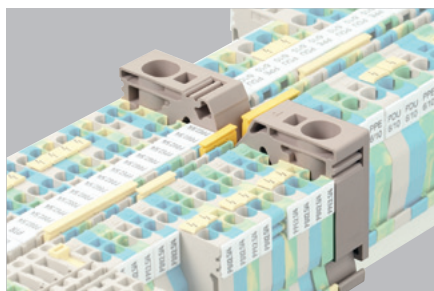

There are three options for supplying power to the Weidmüller PUSH IN modular terminals: the **PEI 16** supply terminals, the PDU 6/10 or the PDU 2.5/4 feed-through terminal. The input current is split into several output currents by means of cross-connections. A 16 mm² conductor carries the incoming supply, which is distributed to the neighbouring terminals with cross-sections from 0.5 to 10 mm².

Electrical distribution

Page B.48

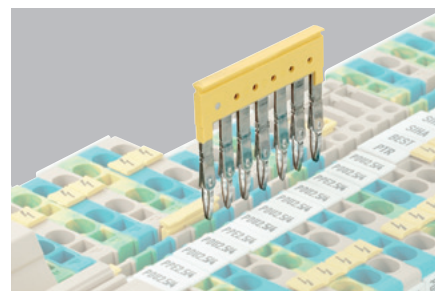

A pluggable **cross-connection system (ZQV)** is available for all P-Series terminals. The current is distributed across any number of terminals by simply plugging the cross-connection into the middle of the terminals. As a rule, 400 V can be transmitted across the cross-section, depending on the rated voltage of the terminal.

Testing / checking

Page B.50

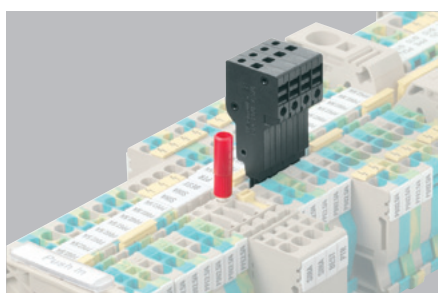

The plug-in **test adapter (PTA)** is used as a single unit and as a test adapter strip for voltage measurement in control cabinets. The test adapter is ideal for convenient testing of assembled terminals. It is simply clipped into the cross-connection channel of the terminal. This ensures that it makes contact with the busbar carrying the current.

Marking

Page B.50

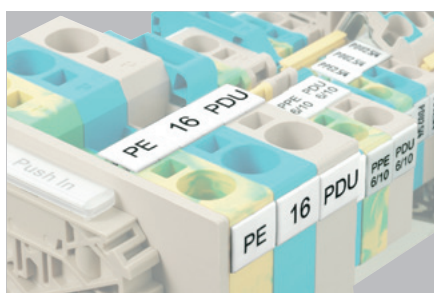

Weidmüller's identification systems in **chapter F** are used to mark PUSH IN technology terminals. Individual terminals, groups of terminals and cables or conductors can be marked. Marker strips are available for every size of terminal, which means that several terminals can be marked together.

Connecting

Page B.53



The PUSH IN connection saves time and requires solid single-core wires or wire-end ferrules. Ferrules have well-established installation advantages. In addition, they guarantee an electrical connection of permanent and consistent quality. By using twin ferrules, it is possible to connect two wires in one terminal point.

Support plates and end plates

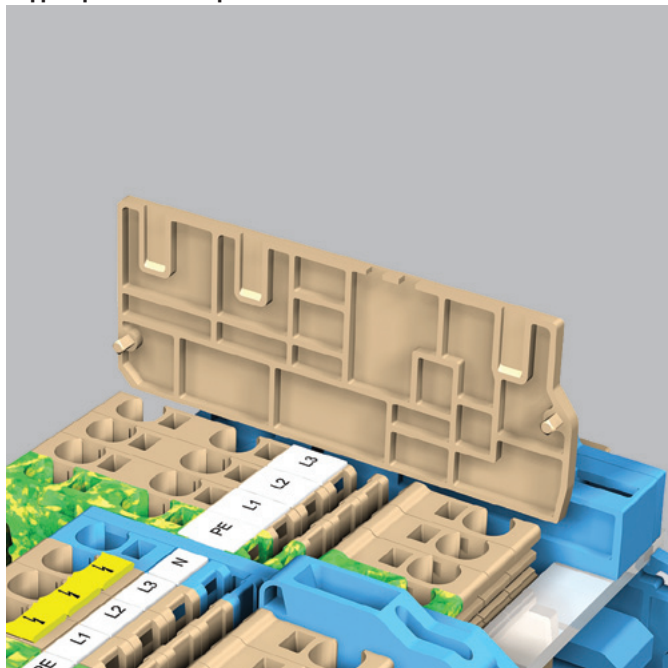

Touch-safe protection

With only a few exceptions, the last terminal in a terminal strip must be closed off with a PAP-type end plate. End plates must also be used within a terminal strip when it makes use of terminals of different sizes. This ensures the touch-safe requirement is met for live voltage components. The terminals have touch protection.

Ensuring the operating voltage

End plates can also be used to maintain the required clearance and creepage distances, in order to guarantee the rated voltage for the application. They can be used, for example, when cross-connections are used side-by-side.

Contour matching

The outer dimensions of the end plates match the external dimensions of the associated terminal.

Mounting

The end plate's snap-in pegs allow it to be simply fitted on to the corresponding terminal. The corresponding indentations in the terminal are used to ensure that position follows the identical contours.

Ordering data

Type	Colour	Qty.	Order No.	For terminal:
Width 3 mm				
PAP PRV/PPV8 SW	black	10	1173720000	PRV 8
PAP PRV/PPV8 GR	grey	10	1211460000	PPV 8
Width 3 mm				
PAP PRV/PPV4 SW	black	10	1173750000	PRV 4
PAP PRV/PPV4 GR	grey	10	1211450000	PPV 4
PAP PRV/PPV4 BL	blue	10	1268010000	
Width 3 mm				
PAP 2.5/4	dark beige	50	1896300000	PDU 2.5/4
PAP 2.5/4 BL	blue	50	1049210000	PDU 2.5/4 BL PNT 2.5/4 PPE 2.5/4
Width 3 mm				
PAP 2.5/4/3AN	dark beige	50	1896480000	PDU 2.5/4 3AN
PAP 2.5/4/3AN BL	blue	50	1052300000	PDU 2.5/4 3AN BL PPE 2.5/4 3AN
Width 3 mm				
PAP 2.5/4/4AN	dark beige	50	1896320000	PDU 2.5/4 2x2
PAP 2.5/4/4AN BL	blue	50	1052290000	PDU 2.5/4 4AN PDU 2.5/4 4AN BL PPE 2.5/4 4AN
Width 2.7 mm				
PAP PDU16S	dark beige	10	1139910000	PDU 16S PPE 16S
Width 1 mm				
PAP PMAK 4	dark beige	20	1221360000	PMAK 4
Width 3 mm				
PAP 16	dark beige	10	1896290000	PDU 16 PDU 16 BL PPE 16
Width 3 mm				
PAP PDU6/10	dark beige	20	1896330000	PDU 6/10
PAP PDU6/10 BL	blue	50	1049200000	PDU 6/10 BL PPE 6/10 PPE 6/10 3AN
Width 3 mm				
PAP PDU6/10/3AN	dark beige	20	1896340000	PDU 6/10 3AN PDU 6/10 3AN BL
Width 3 mm				
PAP PTR2.5/4	dark beige	20	1934680000	PTR 2.5/4 PTR 2.5/4 0 TNHE
Width 3 mm				
PAP PTR2.5/4/3AN	dark beige	20	1934690000	PTR 2.5/4 3AN PTR 2.5/4 3AN 0 TNHE
Width 3 mm				
PAP PTR2.5/4/4AN	dark beige	20	1934700000	PTR 2.5/4 4AN PTR 2.5/4 4AN 0 TNHE
Width 3 mm				
PAP PDK 2.5/4	dark beige	20	1919720000	PDK 2.5/4 PDK 2.5/4 BL PDK 2.5/4 PE PDK 2.5/4L-PE PDK 2.5/4N-L PDK 2.5/4V PDK 2.5/4V BL
Width 3 mm				
PAP PDL4	dark beige	20	1883210000	PDL 4 L/L PDL 4 L/L/PE PDL 4 N/L/PE PDL 4 NT/L PDL 4 NT/L/PE PDL 4/TR/DU/PE PDL 4/TR/DU PDL 4/TR/DU 0 TNHE PDL 4/TR/DU/PE 0 TNHE
Width 3 mm				
PAP PDL4S	dark beige	20	1837070000	PDL4 S/NT/L/PE PDL4 S/L/L PDL 4 S/L PDL4 S/N/L/PE PDL 4 S/N/L PDL 4 S/N PDL4 S/L/L/PE
Width 3 mm				
PHP PNT 2.5/4	blue	20	1896390000	PNT 2.5/4
PHP PNT 2.5/4 SO*	blue	20	1916790000	
Width 3 mm				
PHP PNT 6/10	blue	10	1896100000	PNT 6/10
PHP PNT 6/10 SO*	blue	10	1919710000	
Width 3 mm				
PHP PNT16	blue	10	1896380000	PNT 16
PHP PNT16 SO*	blue	10	1919690000	
Width 3 mm				
PAP PTL/PSI 6/10	dark beige	20	1165320000	PSI 6/10
PAP PTL/PSI 6/10 SW	black	20	1165330000	PTL 6/10 PTD 6/10

*) For a vertical installation position

Feeding with standard terminals

Using standard terminals for the supply is ideal because the feed-through terminals of the P-Series exhibit a very wide clamping range.

Left-hand feed

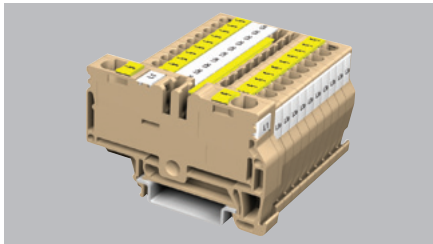

Right-hand feed

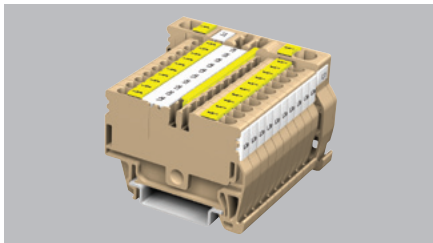

Feed options and cross-connections to be used

Feed terminal	Output terminal	Cross-connection	Left-hand feed	Right-hand feed
PDU 2.5/4	PDU 2.5/4	ZQV 2.5/...	•	•
	PDU 2.5/4/3AN	ZQV 2.5/...	•	
	PDU 2.5/4/4AN	ZQV 2.5/...	•	
	PTR 2.5/4	ZQV 2.5/...	•	
PDU 2.5/4/3AN	PDU 2.5/4	ZQV 2.5/...		•
	PDU 2.5/4/3AN	ZQV 2.5/...	•	•
	PDU 2.5/4/4AN	ZQV 2.5/...	•	
PDU 2.5/4/4AN	PDU 2.5/4	ZQV 2.5/...		•
	PDU 2.5/4/3AN	ZQV 2.5/...		•
	PDU 2.5/4/4AN	ZQV 2.5/...	•	•
PTR 2.5/4	PKD 2.5/4	ZQV 2.5/...	•	
PDU 6/10	PDU 2.5/4	ZQV 2.5/...		•
	PDU 2.5/4/4AN	ZQV 2.5/...	•	
	PDU 6/10	ZQV 6N/...	•	•
	PDU 6/10/3AN	ZQV 6N/...	•	
	PTR 2.5/4	ZQV 2.5/...		•
PDU 6/10/3AN	PDU 2.5/4	ZQV 2.5/...		•
	PDU 2.5/4/3AN	ZQV 2.5/...		•
	PDU 6/10	ZQV 6N/...	•	
	PDU 6/10/3AN	ZQV 6N/...	•	•
	PTR 2.5/4	ZQV 2.5/...		•

Feed terminal PEI 16

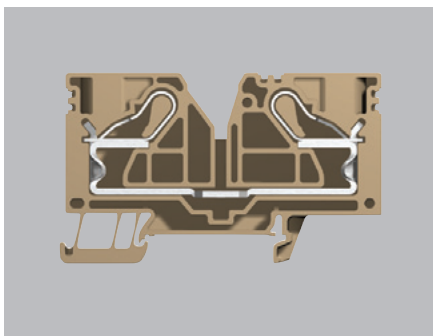

A supply cable with a cross-section of up to 25 mm² is possible with the PEI 16 feed terminal. Standard cross-connections are used to distribute the current to any number of terminals with a smaller cross-section.

The table on the right shows a number of variations for distributing the current with the cross-connection specified.

Output possible on left and right

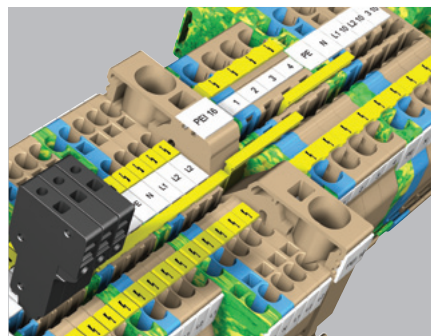

Output options and cross-connections to be used

Feed terminal	Output terminal	Cross-connection	Left-hand feed	Right-hand feed
PEI 16	PDU 2.5/4	ZQV 2.5/...	•	•
	PDU 2.5/4/3AN	ZQV 2.5/...	•	•
	PDU 2.5/4/4AN	ZQV 2.5/...	•	•
	PTR 2.5/4	ZQV 2.5/...		•
	PDU 6/10	ZQV 6N...	•	•
	PDU 6/10 3AN	ZQV 6N...	•	•

Plug-in cross-connection ZQV

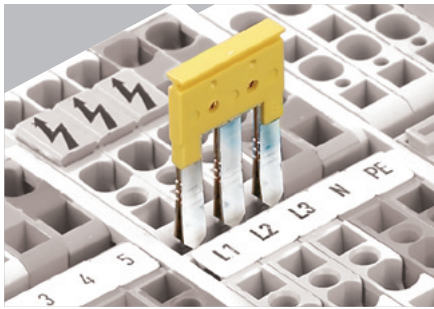

The time-saving, easy-to-use cross-connection combs for terminals, featuring PUSH IN technology.

- **ZQV 2.5** as 2- to 10-pole combs and ZQV2.5/20 – continuous (20-pole)
- **ZQV 6/N** as 2- to 4-pole combs and ZQV6N/20 – continuous (24-pole)
- **ZQV 16/2** as 2-pole comb (link)

These versions come with complete shock protection.

However, please note that the rated voltage is reduced to 400 V when using cross-connections. This does not apply to terminals with a rated voltage below 400 V. Here the rated voltage of the used terminal is mandatory.

Breaking out contact elements

If one or more (max. 60 % for reasons of stability and temperature rise) of the contact elements are broken out of the cross-connections, terminals may be bypassed to suit the application.



Fitting and changing cross-connections

The fitting and changing of cross-connections is a trouble-free and fast operation:

- Insert the cross-connection into the cross-connection channel in the terminal...

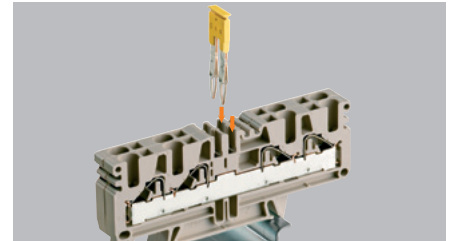

... and press it fully home. (The cross-connection may not project from the channel.)

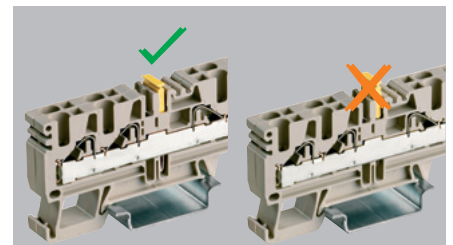

- Remove a cross-connection by simply prising it out with a screwdriver.

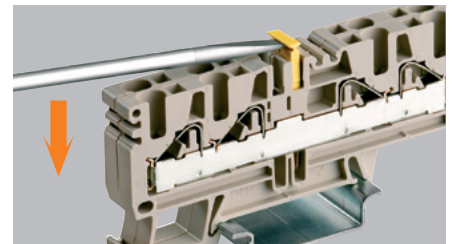

Shortening cross-connections

Cross-connections can be shortened in length using a suitable cutting tool, e.g. KT ZQV (order no. 9002170000). However, three contact elements must always be retained.

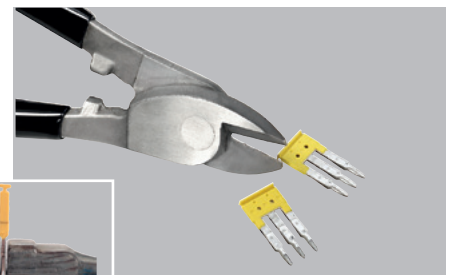

Caution:
Contact elements must not be deformed!



If the user shortens the cross-connections it is necessary to use end plates with the terminals in order to maintain the rated voltage of 250 V (at the bare, cut edges of the cross-connection).

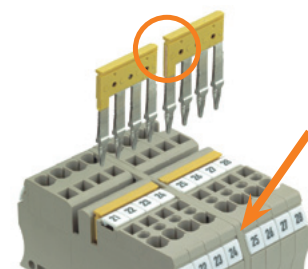

Possible combinations

In one cross-connection channel

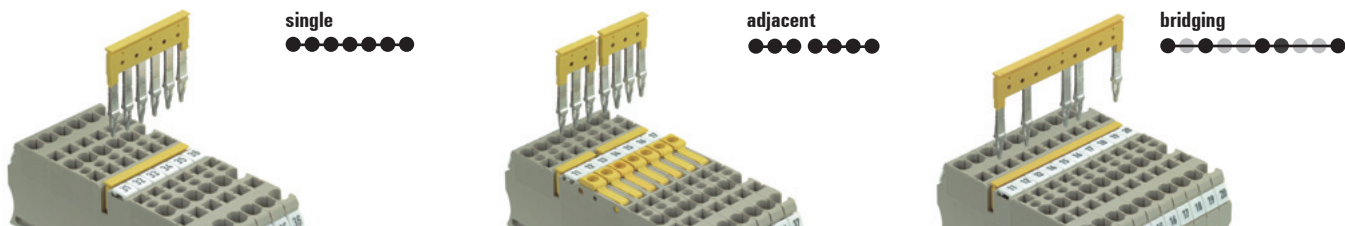

In two cross-connection channels

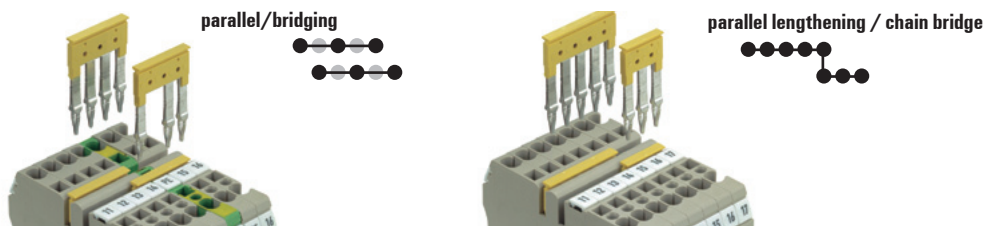

Possible cross-connections of terminals of the same type with corresponding cross-connectors

Terminal type	Cross-connection	single	adjacent	bridging	parallel bridging	chain bridge parallel/lengthening
Standard terminals						
PDU 2.5/4	ZQV 2.5/...	•	•	•	•	•
PDU 2.5/4/3AN	ZQV 2.5/...	•	•	•	•	•
PDU 2.5/4/4AN	ZQV 2.5/...	•	•	•	•	•
PDU 6/10	ZQV 6N/...	•	•	•	•	•
PDU 6/10/3AN	ZQV 6N/...	•	•	•	•	•
PDU 16	ZQV 16/2	•	•			•

The ZQV 2.5/20 cross-connector allows you to easily and separately connect up to 20 terminals with each other. The electrician can cut off the required amount of contact elements from the continuous 20-pole cross-connection comb.

ZQV 2.5



ZQV 6 N



ZQV 16/2



Technical data	
Rated current	A
Ordering data	
2-pole	
3-pole	
4-pole	
5-pole	
6-pole	
7-pole	
8-pole	
9-pole	
10-pole	
20-pole	

24 / 24			
Type	Qty.	Order No.	
ZQV 2.5/2	60	1608860000	
ZQV 2.5/3	60	1608870000	
ZQV 2.5/4	60	1608880000	
ZQV 2.5/5	20	1608890000	
ZQV 2.5/6	20	1608900000	
ZQV 2.5/7	20	1608910000	
ZQV 2.5/8	20	1608920000	
ZQV 2.5/9	20	1608930000	
ZQV 2.5/10	20	1608940000	
ZQV 2.5/20	20	1908960000	
For terminal:			
PDL 4 ...			
PDL 4S ...			
PDU 2.5/4 ...			
PDIC 2.5/4			

57			
Type	Qty.	Order No.	
ZQV 6N/2	60	1906210000	
ZQV 6N/3	60	1906220000	
ZQV 6N/4	60	1906230000	
ZQV 6N/20	20	1906240000	
For terminal:			
PDU 6/10			
PDU 6/10 3AN			
PNT 6/10			

76 / 76			
Type	Qty.	Order No.	
ZQV 16/2	25	1739690000	
For terminal:			
PDU 16			

Test adapter

The clip-on test adapter PTA is used as a single thin element and as a test adapter strip for voltage measurements in electrical cabinets. Conductors with cross-sections from 0.5 mm² to 1.5 mm² can be connected. The test adapter simply clips onto the terminal and thus guarantees reliable contact with the live busbar.

Dimensions	
Width / Length / Height	mm
Stripping length	mm
Rated data	
Rated voltage	V
Rated current	A
Rated cross-section	mm ²
Clamped conductors (H05V/H07V)	
solid / stranded	mm ²
flexible / flexible with ferrule	mm ²
Ordering data	
	1-pole
	With snap-in pegs

PTA

With assembly peg

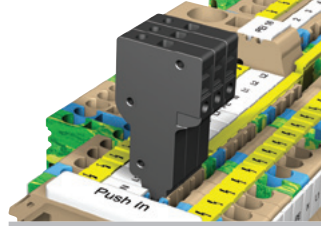

5.1 / 20 / 59		
6		
Technical data		
Product type		
Ordering data		
	For conductor 0.5 mm ² , grey	
	For conductor 1 mm ² , dark grey	
For terminal:		
PDU 2.5/4	25	1916180000
PTA ZA PDU2.5/4	25	1916190000
For terminal:		
PDU 2.5/4		

Reducing sleeves

The use of reducing sleeves simplifies the connection of conductors with smaller cross-sections. Conductors can be reliably inserted into the clamping point without the strands fraying. The use of a reducing sleeve centres the conductor in the entry point.

Packaged in sets of 100 x 10-pole strips

Technical data	
Product type	
Ordering data	
	For conductor 0.5 mm ² , grey
	For conductor 1 mm ² , dark grey

PRH 2.5/4

Reducing sleeves



Reducing sleeve		
Type	Qty.	Order No.
PRH 2.5/4/1	100	1916410000
PRH 2.5/4/2	100	1916400000
For terminal:		
PDU 2.5/4		
PDK 2.5/4		

Cover

The VDE standards call for power connection terminals to be covered. For this purpose, Weidmüller can supply yellow warning PAD covers with the "lightning flash" symbol. The cover is clipped into the screwdriver slit in the terminal and each one covers a group of four terminals.

Technical data	
Product type	
Ordering data	
	Terminal width, 5.1 mm
	Terminal width, 8 mm
	Terminal width, 12 mm

PAD



end plate and intermediate plate		
Type	Qty.	Order No.
PAD 2.5/4/4	80	1916150000
PAD 6/10/4	80	1916160000
PAD 16/4	80	1916170000
For terminal:		
PDU 2.5/4 ...		
PTR 2.5/4 ...		
PDK 2.5/4 ...		
PDU 6/10 ...		
PDU 16 ...		

Label

The BZT marking tags enable you to label the middle of the marking channel with the **WS 10/5** tags. The marking tags can be put together with pins in order to achieve the greatest degree of stability.

Technical data	
Product type	
Ordering data	
	One-sided, without peg
	One-sided, with peg
	Two-sided without pin
	Two-sided, with pin

BZT 1/BZT 2



Marker holder		
Type	Qty.	Order No.
BZT 1 WS 10/5	100	1805490000
BZT 1 ZA WS 10/5	100	1805520000
BZT 2 WS 10/5	100	1805480000
BZT 2 ZA WS 10/5	100	1805530000
For terminal:		
PDK 2.5/4 ...		
PDL 4 ...		

SIHA fuse holder

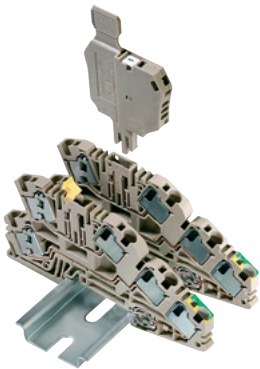

For 5 x 20 G-fuse cartridges

The SIHA fuse holder converts a simple terminal into a fuse terminal in next to no time.

Simply remove the disconnect lever and insert the fuse plug.

Better: order the PDL 4... OTNHE and insert the SIHA immediately.

- Simple handling without tools
- Housing made of Wemid (VO)
- Rated current 6.3 A
- Even fits on 5 mm wide terminals when fitted in offset arrangement



1. Open fuse holder with fingers or screwdriver.

2. Press out old fuse.

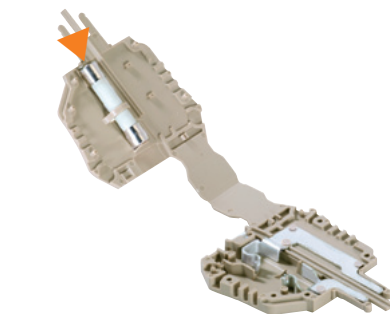

3. Position new fuse.



4. Press fuse holder together again with fingers or screwdriver.



SIHA 3



SIHA STRAP

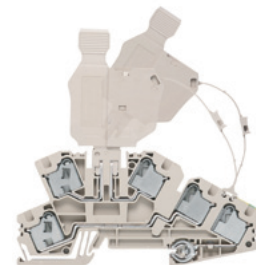

- Identification position for Dekafix 5 and space for the E-Fix self-adhesive label, size 8/20



	Qty.	Order No.
without LED		
SIHA3/G20	400 V 1	7921560000
with LED (red)		
SIHA3/G20		
	10 - 36 V 1	7921570000
	35 - 70 V 1	7921580000
	60 - 150 V 1	7921590000
	140 - 250 V 1	7921600000

For test-disconnect terminals versions

PTR 2.5/4...
PDL 4 TR/...

	Qty.	Order No.
with strap		
SIHA STRAP	20	9537680000

Connector for retro-fit assembly

- Receptacle in the terminal is the identification position
- Integrated identification position on the strap
- Slots into fuse holder either on the left or on the right

Applications with PTR 2.5/4..., PDL 4 TR/... and SIHA 3

		Short-circuit protection		Overload and short-circuit protection	
		Nom. value		Nom. value	
		Power loss	Rated current	Power loss	Rated current
PTR 2.5/4...	Single	4.0 W	6.3 A	1.6 W	6.3 A
	Group	1.6 W	6.3 A		
PDL 4 TR/... und SIHA 3	Single	1.6 W	6.3 A	1.6 W	6.3 A
	Group	1.6 W	6.3 A		

Accessories – Other functions

Fuse carrier ZST 1



The ZST 1 fuse-carrier can hold 6 device fuses (5 x 20 or 5 x 25 mm) which are available for use during servicing work.

ZST 1

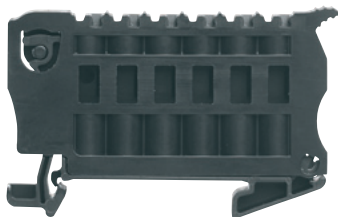

Dimensions		
Width / Length / Height	mm	8 / 62 / 40

Ordering data

Type	Qty.	Order No.
ZST 1	25	1269070000

Component isolating plugs

The Weidmüller philosophy is to realise a multitude of applications with just a few parts. The component and isolating plugs (BEST and TNST) represent a logical extension of this cost-effective and efficient approach. The component plug can accommodate electronic components and connect them to the terminal. And once an isolating plug is removed, the clamping point is obviously disconnected. The opening is easy to recognise.

An unintentional reconnection of the circuit is prevented by simply removing the isolating plug. The BEST and the TNST have the same pin arrangement. Both plugs are also identical with the SIHA 3 fuse holder, meaning that they can be used in all the "disconnecting products" of the W-, Z-, I- and P-Series.

Component plug (up to 250 V)

can be reversed

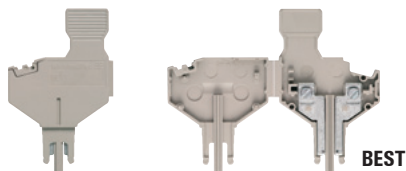

Ordering data

Type	Fitted with...	Qty.	Order No.
BEST	-	25	1833100000
BEST/DRBR	wire jumper	25	1878570000
BEST/D	diode 1N4007	25	1878560000

For terminal type
 PTR 2.5/4...
 PDL 4 TR/...

Isolating plug

Isolating plug



Ordering data

Type	Colour	Qty.	Order No.
TNST	yellow Wemid	25	1833090000

For terminal type
 PTR 2.5/4...
 PDL 4 TR/...

Crimp-Set PZ 6 roto PUSH IN



Assembly

Article description	Type	Qty.
Crimping tools for wire end ferrules 0.14 to 6 mm ²	PZ 6 Roto	1
Stripping tool for up to 6 mm ²	STRIPAX	1
Wire end ferrule with plastic collar, Colour grey	H 4.0/20 DS GR	500
Wire end ferrule with plastic collar, Colour orange	H0.5/16 OR	500
Wire end ferrule with plastic collar, Colour white	H0.75/18 W	500
Wire end ferrule with plastic collar, Colour yellow	H1.0/18 GE	500
Wire end ferrule with plastic collar, Colour black	H1.5/18D SW	500
Wire end ferrule with plastic collar, Colour blue	H2.5/18D BL	500
Wire end ferrule with plastic collar, Colour black	H6.0/20 SW	100

Technical data

Length x Width x Height	340/270/60 mm
Weight	1760 g

Ordering data

Type	Colour code	Order No.
CRIMP-SET PZ 6 ROTO	PI Weidmüller	9028680000

Crimp-Set PZ 16 PUSH IN



Assembly

Article description	Type	Qty.
Crimping tools for wire end ferrules 6 to 16 mm ²	PZ 16	1
Stripping tool for up to 6 mm ²	STRIPAX	1
Wire end ferrule with plastic collar, Colour ivory	H 10.0/22 S EB	100
Wire end ferrule with plastic collar, Colour black	H6.0/20 SW	100
Wire end ferrule with plastic collar, Colour ivory	H10.0/22 EB	100
Wire end ferrule with plastic collar, Colour green	H16.0/24 GN	100

Technical data

Length x Width x Height	340/270/60 mm
Weight	1725 g

Ordering data

Type	Colour code	Order No.
CRIMP-SET PZ 16	Weidmüller	9025850000

Accessories - Wire end ferrules with plastic collar

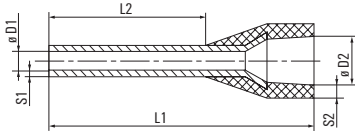

- Polypropylene conical cable entry
- Heat-resistant up to 105 °C
- Cable entry made from non-flammable material on request

For conductors of size 0.14-150 mm² (AWG 26-300MCM)

Material: E-Cu, tin galvanised

Dimensional tolerance acc. to DIN 46228 sect. 4

Weidmüller colour code

packed loose

Ordering data

Type	Ø mm ²	AWG	L1	L2	D1	D2	S1	S2	Stripping length	Colour	Qty.	Order No.
H0.25/12	0.25	24	12.0	8.0	0.8	1.8	0.15	0.25	10.0	light blue	500	9025760000
H0.34/12	0.34	22	12.0	8.0	0.8	2.0	0.15	0.25	10.0	turquoise	500	9025770000
H0.5/14	0.50	20	14.0	8.0	1.0	2.6	0.15	0.25	10.0	orange	500	0690700000
H0.5/16	0.50	20	16.0	10.0	1.0	2.6	0.15	0.25	12.0	orange	500	9025870000
H0.75/14	0.75	18	14.0	8.0	1.2	2.8	0.15	0.25	10.0	white	500	0462900000
H0.75/16	0.75	18	16.0	10.0	1.2	2.8	0.15	0.25	12.0	white	500	9025860000
H0.75/18	0.75	18	18.0	12.0	1.2	2.8	0.15	0.25	14.0	white	500	9025910000
H1.0/14	1.00	17	14.0	8.0	1.4	3.0	0.15	0.25	10.0	yellow	500	0463000000
H1.0/16	1.00	17	16.0	10.0	1.4	3.0	0.15	0.25	12.0	yellow	500	9025950000
H1.0/18	1.00	17	18.0	12.0	1.4	3.0	0.15	0.25	15.0	yellow	500	9025930000
H1.5/14	1.50	16	14.0	8.0	1.7	3.5	0.15	0.25	10.0	red	500	0463100000
H1.5/16	1.50	16	16.0	10.0	1.7	3.5	0.15	0.25	12.0	red	500	0635100000
H2.5/14D	2.50	14	14.0	8.0	2.2	4.2	0.15	0.25	10.0	blue	500	9019160000
H2.5/18D	2.50	14	18.0	12.0	2.2	4.2	0.15	0.25	14.0	blue	500	9019170000
H4.0/20 DS	4.00	12	20.0	12.0	2.8	4.8	0.2	0.3	15.0	grey	500	9203630000
H6.0/20	6.00	10	20.0	12.0	3.5	6.3	0.2	0.3	14.0	black	100	0533500000
H 10.0/22 S	10.00	7	22.0	12.0	4.6	7.1	0.2	0.4	14.0	ivory	100	9203620000
H16.0/24	16.00	6	24.0	12.0	5.8	8.8	0.2	0.4	15.0	green	100	0565900000

Weidmüller colour code

in multi-pack bag

Ordering data

Type	Ø mm ²	AWG	L1	L2	D1	D2	S1	S2	Stripping length	Colour	Qty.	Order No.
H0.14/12	0.14	26	12.0	8.0	0.6	1.5	0.15	0.25	10.0	grey	500	9028240000
H0.25/12	0.25	24	12.0	8.0	0.8	1.8	0.15	0.25	10.0	light blue	500	9025780000
H0.34/12	0.34	22	12.0	8.0	0.8	2.0	0.15	0.25	10.0	turquoise	500	9025790000
H0.5/14	0.50	20	14.0	8.0	1.0	2.6	0.15	0.25	10.0	orange	500	9026060000
H0.5/16	0.50	20	16.0	10.0	1.0	2.6	0.15	0.25	12.0	orange	500	9028270000
H0.75/14	0.75	18	14.0	8.0	1.2	2.8	0.15	0.25	10.0	white	500	9026070000
H0.75/16	0.75	18	16.0	10.0	1.2	2.8	0.15	0.25	12.0	white	500	9028290000
H0.75/18	0.75	18	18.0	12.0	1.2	2.8	0.15	0.25	14.0	white	500	9028300000
H1.0/16	1.00	17	16.0	10.0	1.4	3.0	0.15	0.25	12.0	yellow	500	9028320000
H1.0/18	1.00	17	18.0	12.0	1.4	3.0	0.15	0.25	15.0	yellow	500	9028340000
H1.5/16	1.50	16	16.0	10.0	1.7	3.5	0.15	0.25	12.0	red	500	9028350000

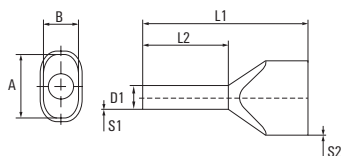

- EPolypropylene conical cable entry
- Heat-resistant up to 105 °C
- Cable entry made from non-flammable material on request

For conductors each at 2 x 0.5 – 2 x 16 mm² (2 x AWG 20 – 2 x AWG 6)

Material: E-Cu, tin galvanised

Dimensional tolerance acc. to DIN 46228 sect. 4

Weidmüller colour code

packed loose

Type
PDU, PPE, PDK, PTR

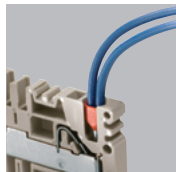

Ordering data

Type	∅ mm ²	AWG	L1	L2	D1	D2	S1	S2	Stripping length	Colour	Qty.	Order No.
H0.5/15	0.50	20	15.0	8.0	1.4		0.15	0.3	11.0	● orange	500	9037200000
H0.5/16.5	0.50	20	16.0	10.0	1.4		0.15	0.3	13.0	● orange	500	9037210000
H0.5/18.5	0.50	20	19.0	12.0	1.4		0.15	0.3	15.0	● orange	500	9037220000
*H0.75/15	0.75	18	15.0	8.0	1.7		0.15	0.3	11.0	○ white	500	9037230000
*H0.75/17	0.75	18	17.0	10.0	1.7		0.15	0.3	13.0	○ white	500	9037240000
*H0.75/19S	0.75	18	19.0	12.0	1.4		0.15	0.3	21.0	○ white	500	9202820000
*H0.75/24.5	0.75	18	24.0	18.0	1.7		0.15	0.3	21.0	○ white	500	9037250000
*H1.0/25.6	1.00	17	25.0	18.0	2.0		0.15	0.3	22.0	● yellow	500	9037280000
*H1.5/25.6	1.50	16	26.0	18.0	2.2		0.15	0.3	21.0	● red	100	9037310000
**H2.5/26.5D	2.50	14	27.0	18.0	2.8		0.15	0.4	21.0	● blue	100	9037520000

Note: * Voltage reduced to 320 V ** Voltage reduced to 160 V

Weidmüller colour code

packed loose

Type
PDL DU/PE



Ordering data

Type	∅ mm ²	AWG	L1	L2	D1	D2	S1	S2	Stripping length	Colour	Qty.	Order No.
H0.5/15	0.50	20	15.0	8.0	1.4		0.15	0.3	11.0	● orange	500	9037200000
H0.5/16.5	0.50	20	16.0	10.0	1.4		0.15	0.3	13.0	● orange	500	9037210000
H0.5/18.5	0.50	20	19.0	12.0	1.4		0.15	0.3	15.0	● orange	500	9037220000
H0.75/15	0.75	18	15.0	8.0	1.7		0.15	0.3	11.0	○ white	500	9037230000
H0.75/17	0.75	18	17.0	10.0	1.7		0.15	0.3	13.0	○ white	500	9037240000
H0.75/19S	0.75	18	19.0	12.0	1.4		0.15	0.3	21.0	○ white	500	9202820000
H0.75/24.5	0.75	18	24.0	18.0	1.7		0.15	0.3	21.0	○ white	500	9037250000
H1.0/25.6	1.00	17	25.0	18.0	2.0		0.15	0.3	22.0	● yellow	500	9037280000
H1.5/25.6	1.50	16	26.0	18.0	2.2		0.15	0.3	21.0	● red	100	9037310000
H2.5/26.5D	2.50	14	27.0	18.0	2.8		0.15	0.4	21.0	● blue	100	9037520000

Hook-type cable connector

according to ESI 50-18 part 2

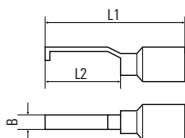

Ordering data

Type	∅ mm ²	Colour	L1	L2	L3	Qty.	Order No.
HB 1-17	0.25 - 1.5	●	27.2	16.75	4.6	100	9036290000
HB 1-13	1.0 - 2.5	●	27.2	16.75	3.0	100	9036300000

Terminals, Z-Series

Terminals, Z-Series	Overview Z-Series	C.2
	Feed-through terminals	C.4
	Double- / Multi-level terminals	C.20
	Motor-connect terminal blocks	C.34
	PE terminals	C.36
	Fuse terminals	C.54
	Test-disconnect terminals	C.66
	Earth wire disconnect terminal blocks	C.71
	Installation terminals	C.72
	Overview WeiCoS	C.80
	Pluggable standard terminals WeiCoS	C.82
	Overview initiator and actuator terminals	C.108
	Initiator and actuator terminals	C.110
	Overview mini terminals	C.112
	Mini terminals	C.114
	Terminals with electronic components	C.120
	Accessories Z-Series	C.128

A broad line of terminal block products with tension-clamp wire connection

A proven solution for every application

The terminal blocks with their proven tension-clamp wire connection system, cannot fail to impress, with their small design, a wide and deep product range and many additional functions and accessories for all applications in electrical cabinet construction.

C

Terminals with tension-clamp connections are tailored specially to the customer's requirements: small design, generous marking areas, integrated test point. The Z-series terminals have a large clamping range and up to two cross-connection channels. Plug-in standard cross-connections enable potentials to be distributed over any number of terminals.

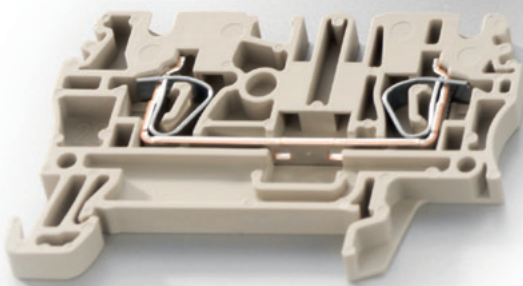
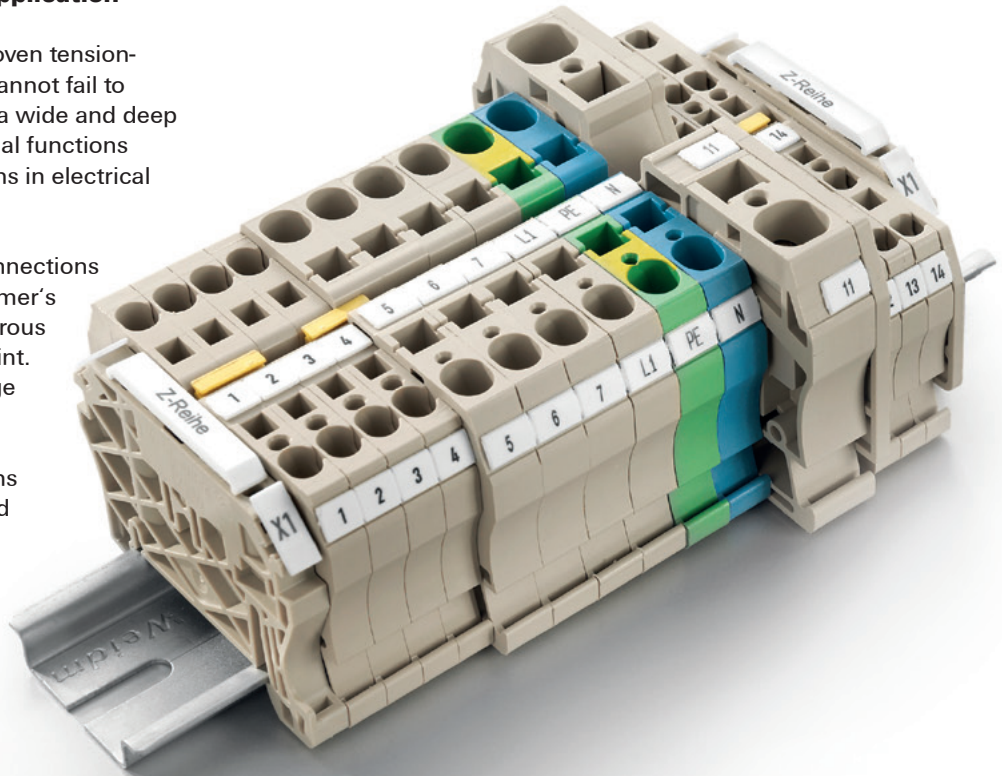

Wemid insulating material

- Non-tracking, CTI 600
- Thermally stable up to 120 °C
- High UL94 flammability class V0
- Contains no halogen or phosphorous

Designs

Z-Standard with wire cross sections from 0.05 to 35 mm² and TOP entry wire insertion parallel to the screwdriver actuators. Z-Roof with wire cross sections from 0.13 to 16 mm², dimensions reduced by up to 36 % and oblique operation direction.

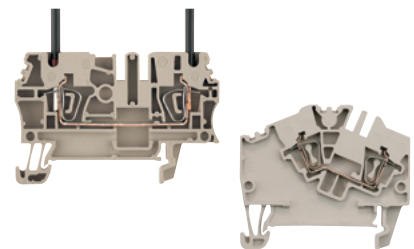
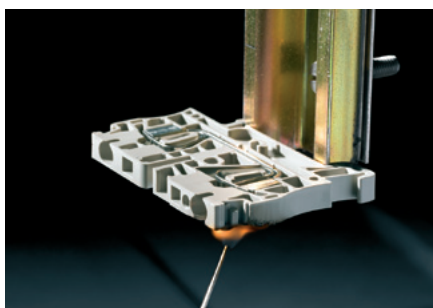

Safe, thanks to the clarity

Easy to use thanks to the large clamping space for the wire connections from 0.08 to 35 mm², only one wire can be connected in each clamping unit.

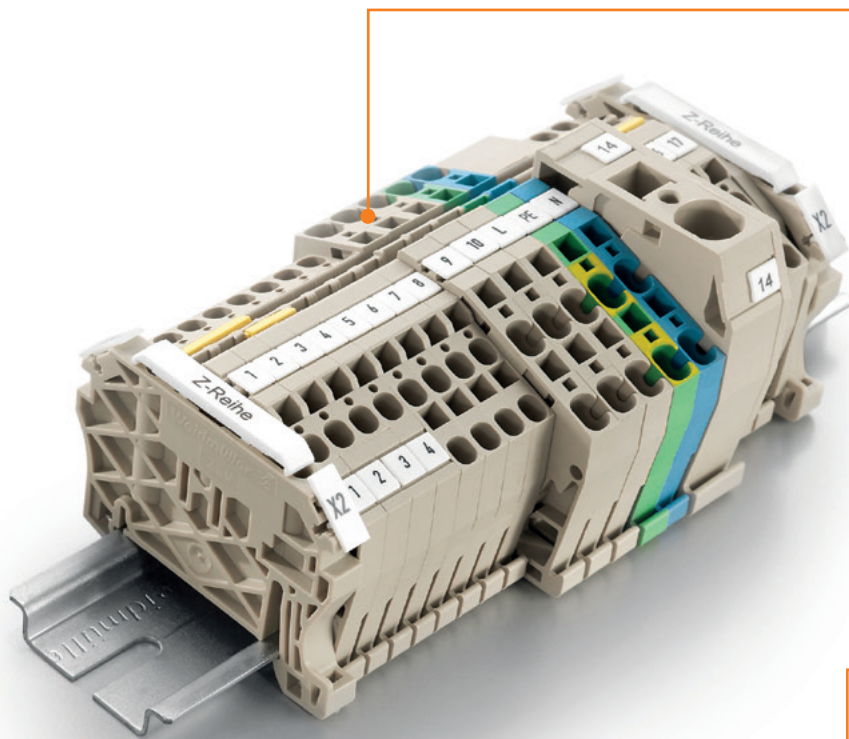

Extensive accessories

Test adapters and plugs, standard and group markers, closing plates and partitions, covers, and reducing sleeves are available for the Z-series.

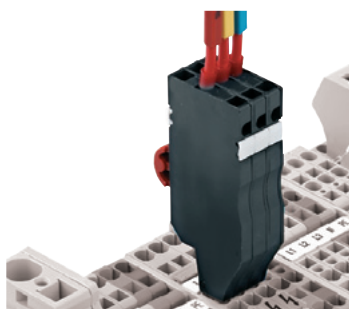

Simple operation

The practical connection aligns the wire insertion direction and the screwdriver operating points, creating a TOP connection system for which no special tools are needed and which comes with an integrated test point.

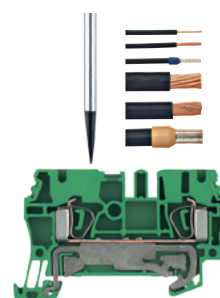

Contact security

The products have maintenance-free connections for a life-long secure contact. They are 100 % shock and vibration proof.



Feed-through terminals

Standard form

Z-series standard ranges provide solutions for conductor cross-sections from 0.05 to 35 mm².

In hazardous area applications, the installation instructions and the rated data specifications for accessories given in the technical appendix must be followed.

Width/Length/Height of lowest version	mm
max. current / max. cond. cross-section	A/mm ²
Max. clamping range	mm ²

Technical data

Rated data	
Rated voltage	V
Rated current	A
Rated cross-section	mm ²
Rated impulse withstand voltage / Pollution severity	
Gauge to IEC 60947-1 / Flammability class UL94	
Approvals	
Clamped conductors (H05V/H07V)	
Solid / stranded	mm ²
Flexible / Flexible with ferrule	mm ²
Stripping length / Blade size	mm/-
Note	

Ordering data

Version	
	Dark beige Wemid
	Blue Wemid
Note	

Accessories

Pluggable cross-connection	
	2-pole
	3-pole
	4-pole
	10-pole
	20-/24-pole
End plate / Partition plate	
	Dark beige Wemid
	Blue Wemid
End bracket	Dark beige Wemid
Test adapter	
	Standard
	With assembly peg
Screwdriver	Standard
Reducing sleeves	
	For conductors < 0.5 mm ² / AWG 20
	For conductors < 1.0 mm ² / AWG 18
Cover	
	With lightning flash symbol
Identification systems	(see assortment in catalogue 7)
	Marking tags
Note	

ZDU 1.5

1.5 mm²

Two connections

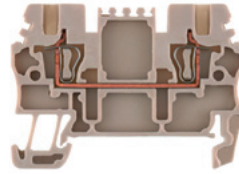

3.5 x 51.5 x 37
17.5 / 1.5
0.05...1.5

IEC 60947-7-1	Ex e II	Ex	II 2 G D
IEC	UL	CSA	EN 60079-7
500	300 (C)	300 (C)	550
17.5	15 (C)	20 (C)	15
1.5	AWG 26...14	AWG 26...14	1.5
6 kV / 3			
B1 / V-0			
KEMA 01ATEX2106 U			
Rated connection			
0.5...1.5			
0.5...1.5 / 0.5...1.5			
10 / 0.4 x 2.0 mm			

Type	Qty.	Order No.
ZDU 1.5	100	1775480000
ZDU 1.5 BL	100	1775490000

Type	current	Qty.	Order No.
ZQV 1.5/2	17.5 A	60	1776120000
ZQV 1.5/3	17.5 A	60	1776130000
ZQV 1.5/4	17.5 A	60	1776140000
ZQV 1.5/10	17.5 A	20	1776200000
Width			
ZAP/TW ZDU1.5/2AN	2 mm	20	1776030000
ZAP/TW ZDU1.5/2AN BL	2 mm	20	1776040000
ZEW 35	6 mm	20	9540000000
ZTA 5	3.5 mm	25	1776210000
ZTA 5/ZA	3.5 mm	25	1776220000
SDS 0.4X2.0X60		1	9037160000
ZRH 1.5S/1	4.55 mm	500	1781950000
ZRH 1.5S/2	4.55 mm	500	1781960000
ZAD 7/4	4.3 mm	20	1781940000

Identification systems	(see assortment in catalogue 7)
	Marking tags
Note	

DEK 5/3,5 / WS 12/3,5

ZDU 1.5/3 AN

1.5 mm²

Three connections

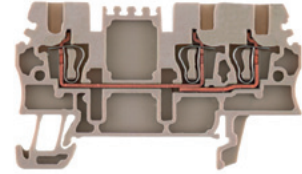

3.5 x 63.5 x 37
17.5 / 1.5
0.05...1.5

IEC 60947-7-1	Ex e II	Ex	II 2 G D
IEC	UL	CSA	EN 60079-7
500	300 (C)	300 (C)	550
17.5	15 (C)	20 (C)	15
1.5	AWG 26...14	AWG 26...14	1.5
6 kV / 3			
B1 / V-0			
KEMA 01ATEX2106 U			
Rated connection			
0.5...1.5			
0.5...1.5 / 0.5...1.5			
10 / 0.4 x 2.0 mm			

Type	Qty.	Order No.
ZDU 1.5/3AN	100	1775530000
ZDU 1.5/3AN BL	100	1775540000

Type	current	Qty.	Order No.
ZQV 1.5/2	17.5 A	60	1776120000
ZQV 1.5/3	17.5 A	60	1776130000
ZQV 1.5/4	17.5 A	60	1776140000
ZQV 1.5/10	17.5 A	20	1776200000
Width			
ZAP/TW ZDU1.5/3AN	2 mm	20	1776060000
ZAP/TW ZDU1.5/3AN BL	2 mm	20	1776070000
ZEW 35	6 mm	20	9540000000
ZTA 5	3.5 mm	25	1776210000
ZTA 5/ZA	3.5 mm	25	1776220000
SDS 0.4X2.0X60		1	9037160000
ZRH 1.5S/1	4.55 mm	500	1781950000
ZRH 1.5S/2	4.55 mm	500	1781960000
ZAD 7/4	4.3 mm	20	1781940000

Identification systems	(see assortment in catalogue 7)
	Marking tags
Note	

DEK 5/3,5 / WS 12/3,5

ZDU 1.5/4 AN

1.5 mm²

Four connections

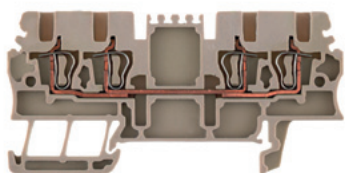

3.5 x 75.5 x 37
17.5 / 1.5
0.05...1.5



IEC 60947-7-1

Ex e II II 2 G D

IEC	UL	CSA	EN 60079-7
500	300 (C)	300 (C)	550
17.5	15 (C)	20 (C)	15
1.5	AWG 26...14	AWG 26...14	1.5

6 kV / 3
B1 / V-0

KEMA 01ATEX2106 U

Rated connection

0.5...1.5
0.5...1.5 / 0.5...1.5
10 / 0.4 x 2.0 mm

Type	Qty.	Order No.
ZDU 1.5/4AN	100	1775580000
ZDU 1.5/4AN BL	100	1775600000

Type	current	Qty.	Order No.
ZQV 1.5/2	17.5 A	60	1776120000
ZQV 1.5/3	17.5 A	60	1776130000
ZQV 1.5/4	17.5 A	60	1776140000
ZQV 1.5/10	17.5 A	20	1776200000

Width			
ZAP/TW ZDU1.5/4AN	2 mm	20	1776090000
ZAP/TW ZDU1.5/4AN BL	2 mm	20	1776100000

ZEW 35	6 mm	20	9540000000
--------	------	----	------------

ZTA 5	3.5 mm	25	1776210000
ZTA 5/ZA	3.5 mm	25	1776220000

SDS 0.4X2.0X60		1	9037160000
----------------	--	---	------------

ZRH 1.5S/1	4.55 mm	500	1781950000
ZRH 1.5S/2	4.55 mm	500	1781960000

ZAD 7/4	4.3 mm	20	1781940000
---------	--------	----	------------

DEK 5/3,5 / WS 12/3,5

ZDU 1.5 2x2AN

1.5 mm²

2 x 2 connections

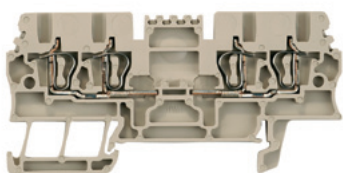

3.5 x 75.5 x 37
17.5 / 1.5
0.05...1.5

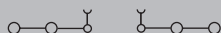

IEC 60947-7-1

IEC	UL	CSA
500		
17.5		
1.5		

6 kV / 3
B1 / V-0

KEMA 01ATEX2106 U

Rated connection

0.5...1.5
0.5...1.5 / 0.5...1.5
10 / 0.4 x 2.0 mm

Type	Qty.	Order No.
ZDU 1.5/2X2AN	100	1826970000
ZDU 1.5/2X2AN BL	100	1826990000

Type	current	Qty.	Order No.
ZQV 1.5/2	17.5 A	60	1776120000
ZQV 1.5/3	17.5 A	60	1776130000
ZQV 1.5/4	17.5 A	60	1776140000
ZQV 1.5/10	17.5 A	20	1776200000

Width			
ZAP/TW ZDU1.5/4AN	2 mm	20	1776090000
ZAP/TW ZDU1.5/4AN BL	2 mm	20	1776100000

ZEW 35	6 mm	20	9540000000
--------	------	----	------------

ZTA 5	3.5 mm	25	1776210000
ZTA 5/ZA	3.5 mm	25	1776220000

SDS 0.4X2.0X60		1	9037160000
----------------	--	---	------------

ZRH 1.5S/1	4.55 mm	500	1781950000
ZRH 1.5S/2	4.55 mm	500	1781960000

ZAD 7/4	4.3 mm	20	1781940000
---------	--------	----	------------

DEK 5/3,5 / WS 12/3,5

ZEI 6

6 mm²

Supply terminal

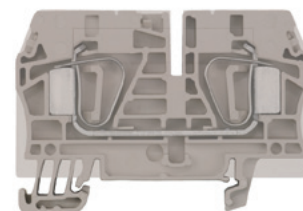

10 x 65 x 45.5
57 / 10
0.5...10

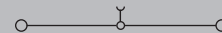

IEC 60947-7-1

IEC	UL	CSA
500		
41		
6		

8 kV / 4
A5 / V-0

KEMA 01ATEX2106 U

Rated connection

0.5...10
0.5...10 / 0.5...6
13 / 1.0 x 5.5 mm

Rated voltage is reduced to 400 V or the rated voltage of the distribution terminals.

Type	Qty.	Order No.
ZEI 6	20	1791190000

Integrated end plate.

Type	current	Qty.	Order No.
ZQV 1.5/2	17.5 A	60	1776120000
ZQV 1.5/3	17.5 A	60	1776130000
ZQV 1.5/4	17.5 A	60	1776140000
ZQV 1.5/10	17.5 A	20	1776200000

Width			
ZEW 35	6 mm	20	9540000000

ZTA 3 ZDU6	8.1 mm	25	1654050000
------------	--------	----	------------

SDIS SL 0.8X4.0X100		1	1274670000
---------------------	--	---	------------

ZAD 3/4	10 mm	20	1609120000
---------	-------	----	------------

DEK 8 / WS 12/6

The plug-in cross-connections ZQV 1.5/... can be used.

Feed-through terminals

Standard form

Z-series standard ranges provide solutions for conductor cross-sections from 0.05 to 35 mm².

In hazardous area applications, the installation instructions and the rated data specifications for accessories given in the technical appendix must be followed.

Width/Length/Height of lowest version	mm
max. current / max. cond. cross-section	A/mm ²
Max. clamping range	mm ²

Technical data

Rated data	
Rated voltage	V
Rated current	A
Rated cross-section	mm ²
Rated impulse withstand voltage / Pollution severity Gauge to IEC 60947-1 / Flammability class UL94	
Approvals	
Clamped conductors (H05V/H07V)	
Solid / stranded	mm ²
Flexible / Flexible with ferrule	mm ²
Stripping length / Blade size	mm/-
Note	

Ordering data

Version	
	Dark beige Wemid
	Blue Wemid
Note	

Accessories

Pluggable cross-connection	
	2-pole
	3-pole
	4-pole
	10-pole
	20-/24-pole
End plate / Partition plate	
	Dark beige Wemid
	Blue Wemid
End bracket	
	Dark beige Wemid
Test adapter	
	Standard
	With assembly peg
Screwdriver	
	Standard
Reducing sleeves	
	For conductors < 0.5 mm ² / AWG 20
	For conductors < 1.0 mm ² / AWG 18
Cover	
	With lightning flash symbol
Identification systems	
	(see assortment in catalogue 7)
	Marking tags
Note	

ZDU 2.5

2.5 mm²

Two connections

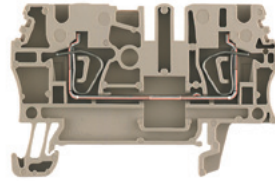

5.1 x 59.5 x 39.5
31 / 4
0.05...4

IEC 60947-7-1	Ex e II	Ex	II 2 G D
IEC	UL	CSA	EN 60079-7
800	600 (C)	600 (C)	550
24	25 (C)	27 (C)	21
2.5	AWG 30...12	AWG 26...12	2.5
8 kV / 3			
A3 / V-0			
KEMA 97ATEX2521 U			
Rated connection			
0.5...4			
0.5...4 / 0.5...2.5			
10 / 0.6 x 3.5 mm			

Type	Qty.	Order No.
ZDU 2.5	100	1608510000
ZDU 2.5 BL	100	1608520000

The rated voltage is reduced to 400 V when using the cross-connection.

Type	current	Qty.	Order No.
ZQV 2.5/2	24 A	60	1608860000
ZQV 2.5/3	24 A	60	1608870000
ZQV 2.5/4	24 A	60	1608880000
ZQV 2.5/10	24 A	20	1608940000
ZQV 2.5/20	24 A	20	1908960000
Width			
ZAP/TW 1	2 mm	50	1608740000
ZAP/TW 1 BL	2 mm	50	1608750000
ZEW 35	6 mm	20	9540000000
ZTA 1	5.1 mm	25	1609040000
ZTA 1/ZA	5.1 mm	25	1609050000
SDIS SL 0.6X3.5X100		1	1274660000
ZRH 2.5/1 WS	5.55 mm	1000	1614300000
ZRH 2.5/2 GR/VO	5.55 mm	1000	1614290000
ZAD 1/4	8 mm	20	1609110000

Identification systems	
	(see assortment in catalogue 7)
	Marking tags
Note	

ZDU 2.5/3AN

2.5 mm²

Three connections

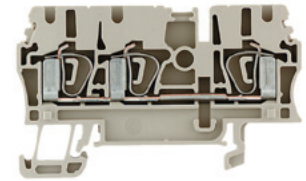

5.1 x 64.5 x 39.5
31 / 4
0.05...4

IEC 60947-7-1	Ex e II	Ex	II 2 G D
IEC	UL	CSA	EN 60079-7
800	600 (C)	600 (C)	550
24	25 (C)	27 (C)	21
2.5	AWG 30...12	AWG 26...12	2.5
8 kV / 3			
A3 / V-0			
KEMA 97ATEX2521 U			
Rated connection			
0.5...4			
0.5...4 / 0.5...2.5			
10 / 0.6 x 3.5 mm			

Type	Qty.	Order No.
ZDU 2.5/3AN	100	1608540000
ZDU 2.5/3AN BL	100	1608550000

The rated voltage is reduced to 400 V when using the cross-connection.

Type	current	Qty.	Order No.
ZQV 2.5/2	24 A	60	1608860000
ZQV 2.5/3	24 A	60	1608870000
ZQV 2.5/4	24 A	60	1608880000
ZQV 2.5/10	24 A	20	1608940000
ZQV 2.5/20	24 A	20	1908960000
Width			
ZAP/TW 2 DB	2 mm	50	1608770000
ZAP/TW 2 BL	2 mm	50	1608780000
ZEW 35	6 mm	20	9540000000
ZTA 1	5.1 mm	25	1609040000
ZTA 1/ZA	5.1 mm	25	1609050000
SDIS SL 0.6X3.5X100		1	1274660000
ZRH 2.5/1 WS	5.55 mm	1000	1614300000
ZRH 2.5/2 GR/VO	5.55 mm	1000	1614290000
ZAD 1/4	8 mm	20	1609110000

Identification systems	
	(see assortment in catalogue 7)
	Marking tags
Note	

ZDU 2.5/4AN

2.5 mm²

Four connections

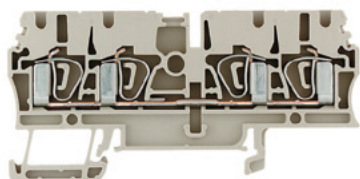

5.1 x 79.5 x 39.5
27 / 4
0.05...4



IEC 60947-7-1

Ex e II II 2 G D

IEC	UL	CSA	EN 60079-7
800	600 (C)	600 (C)	550
24	25 (C)	27 (C)	21
2.5	AWG 30...12	AWG 26...12	2.5

8 kV / 3

A3 / V-0

KEMA 97ATEX2521 U

Rated connection

0.5...4

0.5...4 / 0.5...2.5

10 / 0.6 x 3.5 mm

Type	Qty.	Order No.
ZDU 2.5/4AN	100	1608570000
ZDU 2.5/4AN BL	100	1608580000

Type	current	Qty.	Order No.
ZQV 2.5/2	24 A	60	1608860000
ZQV 2.5/3	24 A	60	1608870000
ZQV 2.5/4	24 A	60	1608880000
ZQV 2.5/10	24 A	20	1608940000
ZQV 2.5/20	24 A	20	1908960000
Width			
ZAP/TW 3	2 mm	50	1608800000
ZAP/TW 3 BL	2 mm	50	1608810000
ZEW 35	6 mm	20	9540000000
ZTA 1	5.1 mm	25	1609040000
ZTA 1/ZA	5.1 mm	25	1609050000
SDIS SL 0.6X3.5X100		1	1274660000
ZRH 2.5/1 WS	5.55 mm	1000	1614300000
ZRH 2.5/2 GR/V0	5.55 mm	1000	1614290000
ZAD 1/4	8 mm	20	1609110000

DEK 5/5 / WS 10/5

ZDU 2.5/2x2AN

2.5 mm²

Two potentials feasible

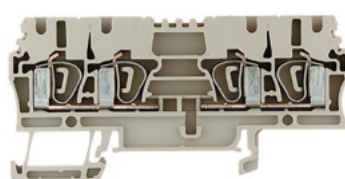

5.1 x 79.5 x 39.5
30 / 4
0.05...4

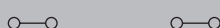

IEC 60947-7-1

Ex e II II 2 G D

IEC	UL	CSA	EN 60079-7
800	600 (C)	600 (C)	550
24	25 (C)	27 (C)	21
2.5	AWG 26...12	AWG 26...12	2.5

8 kV / 3

A3 / V-0

KEMA 97ATEX2521 U

Rated connection

0.5...4

0.5...4 / 0.5...2.5

10 / 0.6 x 3.5 mm

Type	Qty.	Order No.
ZDU 2.5/2X2AN	100	1608600000
ZDU 2.5/2X2AN BL	100	1608610000

Type	current	Qty.	Order No.
ZAP/TW 3	2 mm	50	1608800000
ZAP/TW 3 BL	2 mm	50	1608810000
ZEW 35	6 mm	20	9540000000
ZTA 1	5.1 mm	25	1609040000
ZTA 1/ZA	5.1 mm	25	1609050000
SDIS SL 0.6X3.5X100		1	1274660000
ZRH 2.5/1 WS	5.55 mm	1000	1614300000
ZRH 2.5/2 GR/V0	5.55 mm	1000	1614290000
ZAD 1/4	8 mm	20	1609110000

DEK 5/5 / WS 10/5

Feed-through terminals

Standard form

Z-series standard ranges provide solutions for conductor cross-sections from 0.05 to 35 mm².

In hazardous area applications, the installation instructions and the rated data specifications for accessories given in the technical appendix must be followed.

Width/Length/Height of lowest version	mm
max. current / max. cond. cross-section	A/mm ²
Max. clamping range	mm ²

Technical data

Rated data	
Rated voltage	V
Rated current	A
Rated cross-section	mm ²
Rated impulse withstand voltage / Pollution severity Gauge to IEC 60947-1 / Flammability class UL94	
Approvals	
Clamped conductors (H05V/H07V)	
Solid / stranded	mm ²
Flexible / Flexible with ferrule	mm ²
Stripping length / Blade size	mm/-
Note	

Ordering data

Version	
	Dark beige Wemid
	Blue Wemid
Note	

Accessories

Pluggable cross-connection	
	2-pole
	3-pole
	4-pole
	10-pole
	20-/24-pole
End plate / Partition plate	
	Dark beige Wemid
	Blue Wemid
End bracket	
	Dark beige Wemid
Test adapter	
	Standard
	With assembly peg
Screwdriver	
	Standard
Reducing sleeves	
	For conductors < 0.5 mm ² / AWG 20
	For conductors < 1.0 mm ² / AWG 18
Cover	
	With lightning flash symbol
Identification systems	
	(see assortment in catalogue 7)
	Marking tags
Note	

ZDU 4

4 mm²

Two connections

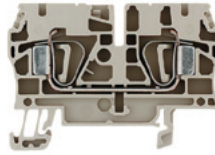

6.1 x 62 x 43.5
41 / 6
0.13...6

IEC 60947-7-1	Ex e II	Ex	II 2 G D
IEC	UL	CSA	EN 60079-7
800	600 (C)	600 (C)	550
32	33 (C)	35 (C)	28
4	AWG 26...10	AWG 26...10	4
8 kV / 3			
A4 / V-0			
KEMA 97ATEX2521 U			
Rated connection			
0.5...6 / 0.5...6			
0.5...6 / 0.5...4			
12 / 0.6 x 3.5 mm			
When using twin ferrules, the rated voltage is 690 V.			

Type	Qty.	Order No.
ZDU 4	100	1632050000
ZDU 4 BL	100	1632060000

Type	current	Qty.	Order No.
ZQV 4/2 GE	32 A	60	1608950000
ZQV 4/3 GE	32 A	60	1608960000
ZQV 4/4 GE	32 A	60	1608970000
ZQV 4/10 GE	32 A	20	1609030000
ZQV 4/20 GE	32 A	20	1909010000
Width			
ZAP/TW 4	2 mm	50	1632090000
ZAP/TW 4 BL	2 mm	50	1632100000
ZEW 35	6 mm	20	9540000000
ZTA 2 ZDU4	6.1 mm	25	1609060000
ZTA 2/ZA ZDU4	6.1 mm	25	1609070000
SDIS SL 0.6X3.5X100		1	1274660000
ZRH 4/1 WS	7.4 mm	1000	1636640000
ZRH 4/2	7.4 mm	1000	1636650000
ZAD 2/4	8.94 mm	20	1609080000

DEK 5/6 / WS 10/6

ZDU 4/3 AN

4 mm²

Three connections

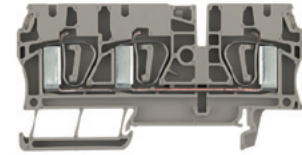

6.1 x 83.5 x 43.5
41 / 6
0.13...6

IEC 60947-7-1	Ex e II	Ex	II 2 G D
IEC	UL	CSA	EN 60079-7
800	600 (C)	600 (C)	550
32	33 (C)	35 (C)	28
4	AWG 26...10	AWG 26...10	4
8 kV / 3			
A4 / V-0			
KEMA 00ATEX2107 U			
Rated connection			
0.5...6 / 0.5...6			
0.5...6 / 0.5...4			
12 / 0.6 x 3.5 mm			
When using twin ferrules, the rated voltage is 690 V.			

Type	Qty.	Order No.
ZDU 4/3AN	50	7904180000
ZDU 4/3AN BL	50	7904190000

Type	current	Qty.	Order No.
ZQV 4/2 GE	32 A	60	1608950000
ZQV 4/3 GE	32 A	60	1608960000
ZQV 4/4 GE	32 A	60	1608970000
ZQV 4/10 GE	32 A	20	1609030000
ZQV 4/20 GE	32 A	20	1909010000
Width			
ZAP/TW 4/3AN	2 mm	20	7904100000
ZAP/TW 4/3AN BL	2 mm	20	7904110000
ZEW 35	6 mm	20	9540000000
ZTA 2 ZDU4	6.1 mm	25	1609060000
ZTA 2/ZA ZDU4	6.1 mm	25	1609070000
SDIS SL 0.6X3.5X100		1	1274660000
ZRH 4/1 WS	7.4 mm	1000	1636640000
ZRH 4/2	7.4 mm	1000	1636650000
ZAD 2/4	8.94 mm	20	1609080000

DEK 5/6 / WS 12/6

ZDU 4/4 AN

4 mm²

Four connections

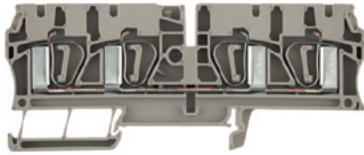

6.1 x 104.5 x 43.5
41 / 6
0.13...6

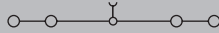

IEC 60947-7-1

Ex e II II 2 G D

IEC	UL	CSA	EN 60079-7
800	600 (C)	600 (C)	550
32	33 (C)	35 (C)	28
4	AWG 26...10	AWG 26...10	4

8 kV / 3
 A4 / V-0

KEMA 00ATEX2107 U

Rated connection

0.5...6 / 0.5...6
 0.5...6 / 0.5...4
 12 / 0.6 x 3.5 mm

When using twin ferrules, the rated voltage is 690 V.

Type	Qty.	Order No.
ZDU 4/4AN	50	7904290000
ZDU 4/4AN BL	50	7904300000

Type	current	Qty.	Order No.
ZQV 4/2 GE	32 A	60	1608950000
ZQV 4/3 GE	32 A	60	1608960000
ZQV 4/4 GE	32 A	60	1608970000
ZQV 4/10 GE	32 A	20	1609030000
ZQV 4/20 GE	32 A	20	1909010000
Width			
ZAP/TW4/4AN	2 mm	20	7904210000
ZAP/TW4/4AN BL	2 mm	20	7904220000
ZEW 35			
ZTA 2 ZDU4	6.1 mm	25	1609060000
ZTA 2/ZA ZDU4	6.1 mm	25	1609070000
SDIS SL 0.6X3.5X100			
		1	1274660000
ZRH 4/1 WS			
	7.4 mm	1000	1636640000
ZRH 4/2			
	7.4 mm	1000	1636650000
ZAD 2/4			
	8.94 mm	20	1609080000

DEK 5/6 / WS 12/6

ZDU 6

6 mm²

Two connections

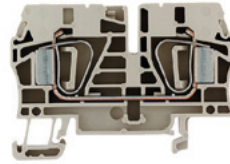

8.1 x 65 x 45.5
57 / 10
0.22...10

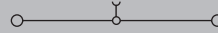

IEC 60947-7-1

Ex e II II 2 G D

IEC	UL	CSA	EN 60079-7
800	600 (C)	600 (C)	550
41	50 (C)	50 (C)	36
6	AWG 22...8	AWG 20...8	6

8 kV / 3
 A5 / V-0

KEMA 97ATEX2521 U

Rated connection

0.5...10
 0.5...10 / 0.5...6
 13 / 1.0 x 5.5 mm

The ZH 0.5 - ZH 2.5 twin ferrules can be used.

Type	Qty.	Order No.
ZDU 6	50	1608620000
ZDU 6 BL	50	1608630000

1000 V DC rated voltage tested.

Type	current	Qty.	Order No.
ZQV 6/2 GE	41 A	60	1627850000
ZQV 6/3 GE	41 A	60	1627860000
ZQV 6/4 GE	41 A	60	1627870000
ZQV 6/24 GE			
	41 A	10	1908990000
Width			
ZAP/TW 5	2 mm	50	1608830000
ZAP/TW 5 BL	2 mm	50	1608840000
ZEW 35			
ZTA 3 ZDU6	8.1 mm	25	1654050000
SDIS SL 1.0X4.5X125			
		1	1274680000
ZAD 3/4			
	10 mm	20	1609120000

DEK 5/8 / WS 12/6

ZDU 6/3 AN

6 mm²

Three connections

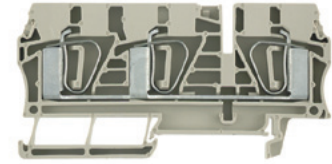

8.1 x 90 x 45.5
57 / 10
0.22...10

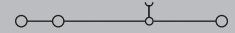

IEC 60947-7-1

Ex e II II 2 G D

IEC	UL	CSA	EN 60079-7
800	600 (C)	600 (C)	550
41	50 (C)	50 (C)	36
6	AWG 22...8	AWG 20...8	6

8 kV / 3
 A5 / V-0

KEMA 00ATEX2107 U

Rated connection

0.5...10
 0.5...10 / 0.5...6
 13 / 1.0 x 5.5 mm

The ZH 0.5 - ZH 2.5 twin ferrules can be used.

Type	Qty.	Order No.
ZDU 6/3AN	50	7907410000
ZDU 6/3AN BL	50	7907420000

Type	current	Qty.	Order No.
ZQV 6/2 GE	41 A	60	1627850000
ZQV 6/3 GE	41 A	60	1627860000
ZQV 6/4 GE	41 A	60	1627870000
ZQV 6/24 GE			
	41 A	10	1908990000
Width			
ZAP/TW6/3AN	2 mm	20	7907370000
ZAP/TW6/3AN BL	2 mm	20	7907380000
ZEW 35			
ZTA 3 ZDU6	8.1 mm	25	1654050000
SDIS SL 1.0X4.5X125			
		1	1274680000
ZAD 3/4			
	10 mm	20	1609120000

DEK 5/8 / WS 12/6

Feed-through terminals

Standard form

Z-series standard ranges provide solutions for conductor cross-sections from 0.05 to 35 mm².

In hazardous area applications, the installation instructions and the rated data specifications for accessories given in the technical appendix must be followed.

Width/Length/Height of lowest version	mm
max. current / max. cond. cross-section	A/mm ²
Max. clamping range	mm ²

Technical data

Rated data	
Rated voltage	V
Rated current	A
Rated cross-section	mm ²
Rated impulse withstand voltage / Pollution severity	
Gauge to IEC 60947-1 / Flammability class UL94	
Approvals	
Clamped conductors (H05V/H07V)	
Solid / stranded	mm ²
Flexible / Flexible with ferrule	mm ²
Stripping length / Blade size	mm/-
Note	

Ordering data

Version	
	Dark beige Wemid
	Blue Wemid
Note	

Accessories

Pluggable cross-connection	
	2-pole
	3-pole
	4-pole
	10-pole
	20-/24-pole
End plate / Partition plate	
	Dark beige Wemid
	Blue Wemid
End bracket	
	Dark beige Wemid
Test adapter	
	Standard
	With assembly peg
Screwdriver	
	Standard
Reducing sleeves	
	For conductors < 0.5 mm ² / AWG 20
	For conductors < 1.0 mm ² / AWG 18
Cover	
	With lightning flash symbol
Identification systems	
	(see assortment in catalogue 7)
	Marking tags
Note	

ZDU 10

10 mm²

Two connections

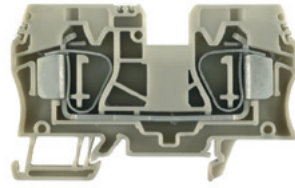

10.1 x 73.5 x 50.5
72 / 16
1.31...16

IEC 60947-7-1	Ex e II	Ex	II 2 G D
IEC	UL	CSA	EN 60079-7
800	600 (C)	600 (C)	550
57	60 (C)	55 (C)	50
10	AWG 16...6	AWG 16...6	10
8 kV / 3			
A6 / V-0			
KEMA 99ATEX5514 U			
Rated connection			
1.5...16 / 1.5...16			
1.5...10 / 1.5...10			
18 / 1.0 x 5.5 mm			
Cross-connection of ZDU 10 and ZDU 16 is possible using the ZDV 16-10. Cross-connection of ZDU 10 and ZDU 35 is possible using the ZDV 35-10.			

Type	Qty.	Order No.
ZDU 10	25	1746750000
ZDU 10 BL	25	1746760000

Type	current	Qty.	Order No.
ZDV 10/2	17.5 A	25	1739680000
Width			
ZAP/TW ZDU10	2.7 mm	20	1748660000
ZAP/TW ZDU10 BL	2.7 mm	20	1764110000
ZEW 35	6 mm	20	9540000000
SDIS SL 1.0X4.5X125		1	1274680000
ZAD 4/5	12.48 mm	20	1746730000

DEK 5/5 / WS 12/5

ZDU 10/3AN

10 mm²

Three connections

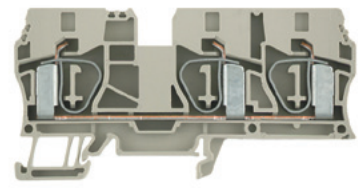

10.1 x 99 x 50.5
57 / 16
1.31...16

IEC 60947-7-1	Ex e II	Ex	II 2 G D
IEC	UL	CSA	EN 60079-7
800	600 (C)	600 (C)	550
57	60 (C)	55 (C)	50
10	AWG 16...6	AWG 16...6	10
8 kV / 3			
A6 / V-0			
KEMA 00ATEX2107 U			
Rated connection			
1.5...16 / 1.5...16			
1.5...10 / 1.5...10			
18 / 1.0 x 5.5 mm			
Cross-connection of ZDU 10 and ZDU 16 is possible using the ZDV 16-10. Cross-connection of ZDU 10 and ZDU 35 is possible using the ZDV 35-10.			

Type	Qty.	Order No.
ZDU 10/3AN	20	1767690000
ZDU 10/3AN BL	20	1767700000

Type	current	Qty.	Order No.
ZDV 10/2	17.5 A	25	1739680000
Width			
ZAP/TW 10/16	3 mm	20	1749580000
ZAP/TW 10/16 BL	3 mm	20	1768520000
ZEW 35	6 mm	20	9540000000
SDIS SL 1.0X4.5X125		1	1274680000
ZAD 4/5	12.48 mm	20	1746730000

DEK 5/5 / WS 12/5

ZDU 16

16 mm²

Two connections

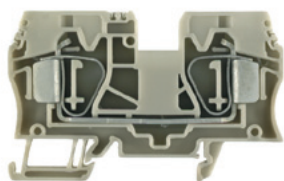

12.1 x 82.5 x 51.5
98 / 25
1.5...25



IEC 60947-7-1

Ex e II II 2 G D

IEC	UL	CSA	EN 60079-7
1000	600 (C)	600 (C)	550
76	65 (C)	65 (C)	66
16	AWG 14...4	AWG 14...4	16

8 kV / 3
 A7 / V-0

KEMA 99ATEX5514 U

Rated connection

1.5...16 / 1.5...25
 1.5...16 / 1.5...16
 18 / 1.0 x 5.5 mm

Cross-connection of ZDU 16 and ZDU 35 is possible using the ZDV 35-16. Cross-connection of ZDU 10 and ZDU 16 is possible using the ZDV 16-10.

Type	Qty.	Order No.
ZDU 16	25	1745230000
ZDU 16 BL	25	1745240000

Type	current	Qty.	Order No.
ZQV 16/2	76 A	25	1739690000
Width			
ZAP/TW ZDU16	3 mm	20	1745150000
ZAP/TW ZDU16 BL	3 mm	20	1764100000
ZEW 35	6 mm	20	9540000000
SDIS SL 1.0X4.5X125		1	1274680000
ZAD 5/5	14.15 mm	20	1745210000

DEK 5/5 / WS 15/5

ZDU 16/3 AN

16 mm²

Three connections

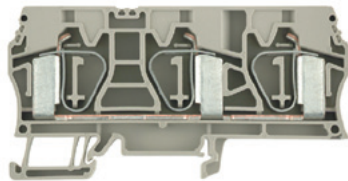

12.1 x 99 x 51.5
76 / 25
1.5...25

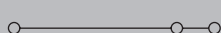

IEC 60947-7-1

Ex e II II 2 G D

IEC	UL	CSA	EN 60079-7
800	600 (C)	600 (C)	550
76	65 (C)	65 (C)	66
16	AWG 14...4	AWG 14...4	16

8 kV / 3
 A7 / V-0

KEMA 00ATEX2107 U

Rated connection

1.5...16 / 1.5...25
 1.5...16 / 1.5...16
 18 / 1.0 x 5.5 mm

Type	Qty.	Order No.
ZDU 16/3AN	20	1768320000
ZDU 16/3AN BL	20	1768330000

Type	current	Qty.	Order No.
ZAP/TW 10/16	3 mm	20	1749580000
ZAP/TW 10/16 BL	3 mm	20	1768520000
ZEW 35	6 mm	20	9540000000
SDIS SL 1.0X4.5X125		1	1274680000
ZAD 5/5	14.15 mm	20	1745210000

DEK 5/5 / WS 15/5

ZEI 16

16 mm²

Supply terminal

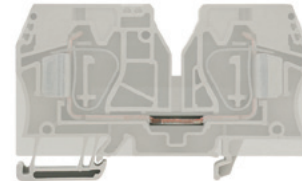

15 x 82.5 x 51.5
76 / 25
1.5...25

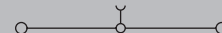

IEC 60947-7-1

IEC	UL	CSA
500	600 (C)	600 (C)
76	65 (C)	65 (C)
16	AWG 14...4	AWG 14...4

8 kV / 3
 A7 / V-0

Rated connection

1.5...16 / 1.5...25
 1.5...16 / 1.5...16
 18 / 1.0 x 5.5 mm

Type	Qty.	Order No.
ZEI 16	20	1745350000
ZEI 16 BL	20	1766240000

Type	current	Qty.	Order No.
ZQV 2.5/2	24 A	60	1608860000
ZQV 4/3 GE	32 A	60	1608960000
ZQV 6/4 GE	41 A	60	1627870000
Width			
ZEW 35	6 mm	20	9540000000
SDIS SL 1.0X4.5X125		1	1274680000
ZAD 5/5	14.15 mm	20	1745210000

DEK 5/5 / WS 15/5

Feed-through terminals

Standard form

Z-series standard ranges provide solutions for conductor cross-sections from 0.05 to 35 mm².

In hazardous area applications, the installation instructions and the rated data specifications for accessories given in the technical appendix must be followed.

Width/Length/Height of lowest version	mm
max. current / max. cond. cross-section	A/mm ²
Max. clamping range	mm ²

Technical data

Rated data	
Rated voltage	V
Rated current	A
Rated cross-section	mm ²
Rated impulse withstand voltage / Pollution severity Gauge to IEC 60947-1 / Flammability class UL94	
Approvals	
Clamped conductors (H05V/H07V)	
Solid / stranded	mm ²
Flexible / Flexible with ferrule	mm ²
Stripping length / Blade size	mm/-

Note

Ordering data

Version	Dark beige Wemid Blue Wemid
---------	--------------------------------

Note

Accessories

Pluggable cross-connection	2-pole 3-pole 4-pole 10-pole 20-/24-pole
End plate / Partition plate	Dark beige Wemid Blue Wemid
End bracket	Dark beige Wemid
Test adapter	Standard With assembly peg
Screwdriver	Standard
Reducing sleeves	For conductors < 0.5 mm ² / AWG 20 For conductors < 1.0 mm ² / AWG 18
Cover	With lightning flash symbol

Identification systems (see assortment in catalogue 7)
Marking tags

Note

ZDU 35

35 mm²

Two connections

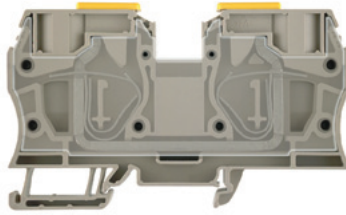

16 x 100.5 x 59.5	
125 / 35	
2.5...35	

IEC 60947-7-1 Ex e II II 2 G D

IEC	UL	CSA	EN 60079-7
800	600 (C)	600 (C)	550
125	120 (C)	120 (C)	109
35	AWG 12...2	AWG 12...2	35
8 kV / 3			
A8 / V-0			

KEMA 00ATEX2107 U

Rated connection	
2.5...16 / 2.5...35	
2.5...35 / 2.5...35	
25 / 1.0 x 5.5 mm	

Cross-connection of ZDU 10 and ZDU 35 is possible using the ZDV 35-10. Cross-connection of ZDU 16 and ZDU 35 is possible using the ZDV 35-16.

Type	Qty.	Order No.
ZDU 35	10	1739620000
ZDU 35 BL	10	1739630000
Integrated end plate.		

Type	current	Qty.	Order No.
ZDV 35/2	105 A	10	1739700000
Width			
ZEW 35	6 mm	20	9540000000
SDIS SL 1.0X4.5X125		1	1274680000
ZAD 6/5	18.74 mm	20	1752620000

Feed-through terminals

Roof-style

The compact terminal range for conductor cross-sections 0.13 to 16 mm².

In hazardous area applications, the installation instructions and the rated data specifications for accessories given in the technical appendix must be followed.

Width/Length/Height of lowest version	mm
max. current / max. cond. cross-section	A/mm ²
Max. clamping range	mm ²

Technical data

Rated data	
Rated voltage	V
Rated current	A
Rated cross-section	mm ²
Rated impulse withstand voltage / Pollution severity Gauge to IEC 60947-1 / Flammability class UL94	
Approvals	
Clamped conductors (H05V/H07V)	
Solid / stranded	mm ²
Flexible / Flexible with ferrule	mm ²
Stripping length / Blade size	mm/-
Note	

Ordering data

Version	
	Dark beige Wemid
	Blue Wemid
Note	

Accessories

Pluggable cross-connection	
	2-pole
	3-pole
	4-pole
	10-pole
	20-/24-pole
End plate / Partition plate	
	Dark beige Wemid
	Blue Wemid
End bracket	
	Dark beige Wemid
Test adapter	
	With assembly peg
Screwdriver	
	Standard
Reducing sleeves	
	For conductors < 0.5 mm ² / AWG 20
	For conductors < 1.0 mm ² / AWG 18
Cover	
	With lightning flash symbol

Identification systems	
	(see assortment in catalogue 7)
	Marking tags
Note	

ZDU 2.5-2

2.5 mm²

Two connections

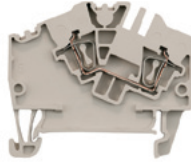

5.1 x 50.5 x 44
24 / 4
0.13...4

IEC 60947-7-1		Ex e II		II 2 G D	
IEC	UL	CSA	EN 60079-7		
800	600 (C)	600 (C)	550		
24	24 (C)	24 (C)	21		
2.5	AWG 26...12	AWG 26...12	2.5		
8 kV / 3					
A2 / V-0					
KEMA 97ATEX4677 U					
Rated connection					
0.5...4					
0.5...2.5 / 0.5...2.5					
10 / 0.6 x 3.5 mm					
2.5 mm ² flexible wires with wire-end ferrules are crimped with the Weidmüller PZ 6/5 crimping tool.					

Type	Qty.	Order No.
ZDU 2.5-2	100	1772060000
ZDU 2.5-2 BL	100	1772070000
The rated voltage is reduced to 400 V when using the cross-connection.		

Type	current	Qty.	Order No.
ZQV 2.5/2	24 A	60	1608860000
ZQV 2.5/3	24 A	60	1608870000
ZQV 2.5/4	24 A	60	1608880000
ZQV 2.5/10	24 A	20	1608940000
ZQV 2.5/20	24 A	20	1908960000
Width			
ZAP/TW7	2.5 mm	50	1706110000
ZAP/TW7 BL	2.5 mm	50	1706120000
ZEW 35	6 mm	20	9540000000
ZTA 4	5.1 mm	25	1688110000
SDIS SL 0.6X3.5X100		1	1274660000
ZRH 1.5H/1	4.85 mm	1000	1678810000
ZRH 1.5H/2	4.85 mm	1000	1678800000
ZAD 1/4-2 GE	8 mm	20	1764560000

Identification systems	
	(see assortment in catalogue 7)
	Marking tags
Note	
	DEK 5/5 / WS 14/5
	The rated voltage is decreased to 250 V when using the shielding rail LS 2.8 (1056400000).

ZDU 2.5-2/3AN

2.5 mm²

Three connections

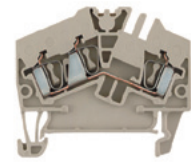

5.1 x 50.5 x 44
24 / 4
0.13...4

IEC 60947-7-1		Ex e II		II 2 G D	
IEC	UL	CSA	EN 60079-7		
800	600 (C)	600 (C)	550		
24	20 (C)	23 (C)	21		
2.5	AWG 26...12	AWG 26...14	2.5		
8 kV / 3					
A2 / V-0					
KEMA 97ATEX4677 U					
Rated connection					
0.5...4					
0.5...2.5 / 0.5...2.5					
10 / 0.6 x 3.5 mm					
2.5 mm ² flexible wires with wire-end ferrules are crimped with the Weidmüller PZ 6/5 crimping tool.					

Type	Qty.	Order No.
ZDU 2.5-2/3AN	100	1706010000
ZDU 2.5-2/3AN BL	100	1706040000
The rated voltage is reduced to 400 V when using the cross-connection.		

Type	current	Qty.	Order No.
ZQV 2.5/2	24 A	60	1608860000
ZQV 2.5/3	24 A	60	1608870000
ZQV 2.5/4	24 A	60	1608880000
ZQV 2.5/10	24 A	20	1608940000
ZQV 2.5/20	24 A	20	1908960000
Width			
ZAP/TW7	2.5 mm	50	1706110000
ZAP/TW7 BL	2.5 mm	50	1706120000
ZEW 35	6 mm	20	9540000000
ZTA 4	5.1 mm	25	1688110000
SDIS SL 0.6X3.5X100		1	1274660000
ZRH 1.5H/1	4.85 mm	1000	1678810000
ZRH 1.5H/2	4.85 mm	1000	1678800000
ZAD 1/4-2 GE	8 mm	20	1764560000

Identification systems	
	(see assortment in catalogue 7)
	Marking tags
Note	
	DEK 5/5 / WS 14/5
	The rated voltage is decreased to 250 V when using the shielding rail LS 2.8 (1056400000).

ZDU 2.5-2/4AN

2.5 mm²

Four connections



5.1 x 50.5 x 44
24 / 4
0.13...4



IEC 60947-7-1

Ex e II II 2 G D

IEC	UL	CSA	EN 60079-7
800	600 (C)	600 (C)	550
24	20 (C)	23 (C)	21
2.5	AWG 26...12	AWG 26...14	2.5

8 kV / 3

A2 / V-0

KEMA 97ATEX4677 U

Rated connection

0.5...4
 0.5...2.5 / 0.5...2.5
 10 / 0.6 x 3.5 mm

2.5 mm² flexible wires with wire-end ferrules are crimped with the Weidmüller PZ 6/5 crimping tool.

Type	Qty.	Order No.
ZDU 2.5-2/4AN	100	1706060000
ZDU 2.5-2/4AN BL	100	1706070000

The wire cross section is decreased to 1.5 mm² when using the ZQB 2.5 for single core and finely stranded wires.

Type	current	Qty.	Order No.
ZQB 2.5-2	24 A	50	1677120000
Width			
ZAP/TW7	2.5 mm	50	1706110000
ZAP/TW7 BL	2.5 mm	50	1706120000
ZEW 35	6 mm	20	9540000000
ZTA 4	5.1 mm	25	1688110000
SDIS SL 0.6X3.5X100		1	1274660000
ZRH 1.5H/1	4.85 mm	1000	1678810000
ZRH 1.5H/2	4.85 mm	1000	1678800000
ZAD 1/4-2 GE	8 mm	20	1764560000

DEK 5/5 / WS 14/5

The rated voltage is decreased to 250 V when using the shielding rail LS 2.8 (1056400000).

ZDU 4-2

4 mm²

Two connections



6.1 x 61.5 x 46
32 / 6
0.13...6



IEC 60947-7-1

Ex e II II 2 G D

IEC	UL	CSA	EN 60079-7
800	600 (C)	600 (C)	550
32	33 (C)	35 (C)	28
4	AWG 26...10	AWG 26...10	4

8 kV / 3

A3 / V-0

KEMA 97ATEX4677 U

Rated connection

0.5...6
 0.5...4 / 0.5...4
 10 / 0.6 x 3.5 mm

Type	Qty.	Order No.
ZDU 4-2/2AN	100	1770370000
ZDU 4-2/2AN BL	100	1770840000

The rated voltage is reduced to 400 V when using the cross-connection.

Type	current	Qty.	Order No.
ZQV 4/2 GE	32 A	60	1608950000
ZQV 4/3 GE	32 A	60	1608960000
ZQV 4/4 GE	32 A	60	1608970000
ZQV 4/10 GE	32 A	20	1609030000
ZQV 4/20 GE	32 A	20	1909010000
Width			
ZAP ZDU4-2	2 mm	50	1770400000
ZAP ZDU4-2 BL	2 mm	50	1770880000
ZEW 35	6 mm	20	9540000000
ZTA 6/ZTA	6.1 mm	25	1780660000
SDIS SL 0.6X3.5X100		1	1274660000
ZAD 1/4	8 mm	20	1609110000

DEK 5/6 / WS 12/6

The rated voltage is decreased to 250 V when using the shielding rail LS 2.8 (1056400000).

ZDU 4-2/3AN

4 mm²

Three connections



6.1 x 61.5 x 46
38 / 6
0.13...6

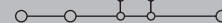

IEC 60947-7-1

Ex e II II 2 G D

IEC	UL	CSA	EN 60079-7
800	600 (C)	600 (C)	550
32	33 (C)	35 (C)	28
4	AWG 26...10	AWG 26...10	4

8 kV / 3

A3 / V-0

KEMA 97ATEX4677 U

Rated connection

0.5...6
 0.5...4 / 0.5...4
 10 / 0.6 x 3.5 mm

Type	Qty.	Order No.
ZDU 4-2/3AN	100	1770360000
ZDU 4-2/3AN BL	100	1770860000

The rated voltage is reduced to 400 V when using the cross-connection.

Type	current	Qty.	Order No.
ZQV 4/2 GE	32 A	60	1608950000
ZQV 4/3 GE	32 A	60	1608960000
ZQV 4/4 GE	32 A	60	1608970000
ZQV 4/10 GE	32 A	20	1609030000
ZQV 4/20 GE	32 A	20	1909010000
Width			
ZAP ZDU4-2	2 mm	50	1770400000
ZAP ZDU4-2 BL	2 mm	50	1770880000
ZEW 35	6 mm	20	9540000000
ZTA 6/ZTA	6.1 mm	25	1780660000
SDIS SL 0.6X3.5X100		1	1274660000
ZAD 1/4	8 mm	20	1609110000

WS 12/6

The rated voltage is decreased to 250 V when using the shielding rail LS 2.8 (1056400000).

Feed-through terminals

Roof-style

The compact terminal range for conductor cross-sections 0.13 to 16 mm²

In hazardous area applications, the installation instructions and the rated data specifications for accessories given in the technical appendix must be followed.

Width/Length/Height of lowest version	mm
max. current / max. cond. cross-section	A/mm ²
Max. clamping range	mm ²

Technical data

Rated data	
Rated voltage	V
Rated current	A
Rated cross-section	mm ²
Rated impulse withstand voltage / Pollution severity Gauge to IEC 60947-1 / Flammability class UL94	
Approvals	
Clamped conductors (H05V/H07V)	
Solid / stranded	mm ²
Flexible / Flexible with ferrule	mm ²
Stripping length / Blade size	mm/-
Note	

Ordering data

Version	
	Dark beige Wemid
	Blue Wemid
Note	

Accessories

Pluggable cross-connection	
	2-pole
	3-pole
	4-pole
	10-pole
	20-/24-pole
End plate / Partition plate	
	Dark beige Wemid
	Blue Wemid
End bracket	
	Dark beige Wemid
Test adapter	
	With assembly peg
Screwdriver	
	Standard
Reducing sleeves	
	For conductors < 0.5 mm ² / AWG 20
	For conductors < 1.0 mm ² / AWG 18
Cover	
	With lightning flash symbol
Identification systems	
	(see assortment in catalogue 7)
	Marking tags
Note	

ZDU 4-2/3AN LSC

4 mm²

Three connections



6.1 x 61.5 x 46
38 / 6
0.13...6

IEC 60947-7-1	Ex e II	Ex	II 2 G D
IEC	UL	CSA	EN 60079-7
800			550
32			28
4			4
8 kV / 3			
A3 / V-0			
KEMA 97ATEX4677 U			
Rated connection			
0.5...6			
0.5...4 / 0.5...4			
10 / 0.6 x 3.5 mm			
The ZDU 4-2/3AN LSC version can be mounted on a 40mm Lütze frame.			

Type	Qty.	Order No.
ZDU 4-2/3AN LSC	100	1790520000
The rated voltage is reduced to 400 V when using the cross-connection.		

Type	current	Qty.	Order No.
ZQV 4/2 GE	32 A	60	1608950000
ZQV 4/3 GE	32 A	60	1608960000
ZQV 4/4 GE	32 A	60	1608970000
ZQV 4/10 GE	32 A	20	1609030000
ZQV 4/20 GE	32 A	20	1909010000
Width			
ZAP ZDU4-2	2 mm	50	1770400000
ZAP ZDU4-2 BL	2 mm	50	1770880000
ZEW 35	6 mm	20	9540000000
ZTA 6/ZA	6.1 mm	25	1780660000
SDIS SL 0.6X3.5X100		1	1274660000
ZAD 1/4	8 mm	20	1609110000

DEK 5/6 / WS 12/6
The rated voltage is decreased to 250 V when using the shielding rail LS 2.8 (1056400000).

ZDU 4-2/4AN

4 mm²

Four connections



6.1 x 75.1 x 46
32 / 6
0.13...6

IEC 60947-7-1	Ex e II	Ex	II 2 G D
IEC	UL	CSA	EN 60079-7
800	600 (C)	600 (C)	550
32	33 (C)	35 (C)	28
4	AWG 26...10	AWG 26...10	4
8 kV / 3			
A3 / V-0			
KEMA 97ATEX4677 U			
Rated connection			
0.5...6			
0.5...4 / 0.5...4			
10 / 0.6 x 3.5 mm			

Type	Qty.	Order No.
ZDU 4-2/4AN	100	1806980000
ZDU 4-2/4AN BL	100	1806990000
The rated voltage is reduced to 400 V when using the cross-connection.		

Type	current	Qty.	Order No.
ZQV 4/2 GE	32 A	60	1608950000
ZQV 4/3 GE	32 A	60	1608960000
ZQV 4/4 GE	32 A	60	1608970000
ZQV 4/10 GE	32 A	20	1609030000
ZQV 4/20 GE	32 A	20	1909010000
Width			
ZAP ZDU4-2/4AN	2 mm	50	1807010000
ZAP ZDU4-2/4AN BL	2 mm	50	1807020000
ZEW 35	6 mm	20	9540000000
ZTA 6/ZA	6.1 mm	25	1780660000
SDIS SL 0.6X3.5X100		1	1274660000
ZAD 1/4	8 mm	20	1609110000

DEK 5/6 / WS 12/6

ZDU 6-2/2AN

6 mm²

Two connections



8.1 x 68 x 50
41 / 10
0.22...10



IEC 60947-7-1

Ex e II II 2 G D

IEC	UL	CSA	EN 60079-7
800	600 (C)	600 (C)	550
41	45 (C)	50 (C)	36
6	AWG 22...8	AWG 20...8	6
8 kV / 3			
A5 / V-0			

KEMA 97ATEX4677 U

Rated connection
0.5...10
0.5...10 / 0.5...6
12 / 0.6 x 3.5 mm, 0.8 x 4.0 mm

Type	Qty.	Order No.
ZDU 6-2/2AN	50	1771380000
ZDU 6-2/2AN BL	50	1771390000

The rated voltage is reduced to 400 V when using the cross-connection.

Type	current	Qty.	Order No.
ZQV 6/2 GE	41 A	60	1627850000
ZQV 6/3 GE	41 A	60	1627860000
ZQV 6/4 GE	41 A	60	1627870000
ZQV 6/24 GE	41 A	10	1908990000
Width			
ZAP ZDU6-2	2 mm	50	1771440000
ZEW 35	6 mm	20	9540000000
ZTA 7/ZA	8.1 mm	25	1780670000
SDIS SL 0.8X4.0X100		1	1274670000

DEK 5/8

ZDU 6-2/3AN

6 mm²

Three connections



8.1 x 68 x 50
41 / 10
0.22...10



IEC 60947-7-1

Ex e II II 2 G D

IEC	UL	CSA	EN 60079-7
800	600 (C)	600 (C)	550
41	45 (C)	50 (C)	36
6	AWG 22...8	AWG 20...8	6
8 kV / 3			
A5 / V-0			

KEMA 97ATEX4677 U

Rated connection
0.5...10
0.5...10 / 0.5...6
12 / 0.6 x 3.5 mm, 0.8 x 4.0 mm

Type	Qty.	Order No.
ZDU 6-2/3AN	50	1771410000
ZDU 6-2/3AN BL	50	1771420000

The rated voltage is reduced to 400 V when using the cross-connection.

Type	current	Qty.	Order No.
ZQV 6/2 GE	41 A	60	1627850000
ZQV 6/3 GE	41 A	60	1627860000
ZQV 6/4 GE	41 A	60	1627870000
ZQV 6/24 GE	41 A	10	1908990000
Width			
ZAP ZDU6-2	2 mm	50	1771440000
ZEW 35	6 mm	20	9540000000
ZTA 7/ZA	8.1 mm	25	1780670000
SDIS SL 0.8X4.0X100		1	1274670000

DEK 5/8

ZEI 16-2 / 1 AN

16 mm²

Supply terminal



14 x 61.5 x 51.5
76 / 25
1.5...25



IEC 60947-7-1

IEC	UL	CSA
800	600 (C)	600 (C)
76	65 (C)	65 (C)
16	AWG 14...4	AWG 14...4
6 kV / 3		
A7 / V-0		

Rated connection
1.5...10 / 16...25
1.5...16 / 1.5...16
18 / 1.0 x 5.5 mm

Rated voltage is reduced to 400 V or the IP rated voltage of the distribution terminals.

Type	Qty.	Order No.
ZEI 16-2/1AN	20	1772940000
ZEI 16-2/1AN BL	20	1772950000

Integrated end plate.

Type	current	Qty.	Order No.
ZQV 2.5/2	24 A	60	1608860000
ZQV 4/3 GE	32 A	60	1608960000
ZQV 6/4 GE	41 A	60	1627870000
Width			
ZAP/Z...16-2/1AN	2.5 mm	10	1772970000
ZEW 35	6 mm	20	9540000000
SDIS SL 1.0X4.5X125		1	1274680000

DEK 8
The plug-in cross-connections ZQV 2.5/..., ZQV 4/... and ZQV 6/... can be used.

Feed-through terminals

Compact style

In hazardous area applications, the installation instructions and the rated data specifications for accessories given in the technical appendix must be followed.

Width/Length/Height of lowest version	mm
max. current / max. cond. cross-section	A/mm ²
Max. clamping range	mm ²

Technical data

Rated data	
Rated voltage	V
Rated current	A
Rated cross-section	mm ²
Rated impulse withstand voltage / Pollution severity Gauge to IEC 60947-1 / Flammability class UL94	
Approvals	
Clamped conductors (H05V/H07V)	
Solid / stranded	mm ²
Flexible / Flexible with ferrule	mm ²
Stripping length / Blade size	mm/-
Note	

Ordering data

Version	
	Dark beige Wemid
	Blue Wemid
Note	

Accessories

Pluggable cross-connection	
	2-pole
	3-pole
	4-pole
	10-pole
	20-/24-pole
End plate / Partition plate	
	Dark beige Wemid
End bracket	
	Dark beige Wemid
Test adapter	
	Standard
	With assembly peg
Screwdriver	
	Standard
Reducing sleeves	
	For conductors < 0.5 mm ² / AWG 20
	For conductors < 1.0 mm ² / AWG 18
Cover	
	With lightning flash symbol

Identification systems	
	(see assortment in catalogue 7)
	Marking tags
Note	

ZDU 2.5N

2.5 mm²

2 connections

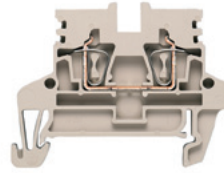

5.1 x 50.5 x 39
24 / 4
0.05...4

IEC 60947-7-1	II 2 G D	
IEC	UL	CSA
800	300 (C)	300 (C)
24	20 (C)	24 (C)
2.5	AWG 30...12	AWG 30...12
6 kV / 3		
A2 / V-0		
Rated connection		
0.5...4 / 1.5...2.5		
0.5...2.5 / 0.5...1.5		
10 / 0.6 x 3.5 mm		
2.5 mm ² flexible wires with wire-end ferrules are crimped with the Weidmüller PZ 6/5 crimping tool.		

Type	Qty.	Order No.
ZDU 2.5N	50	1933700000
ZDU 2.5N BL	50	1933710000

Type	current	Qty.	Order No.
ZQV 2.5/2	24 A	60	1608860000
ZQV 2.5/3	24 A	60	1608870000
ZQV 2.5/4	24 A	60	1608880000
ZQV 2.5/10	24 A	20	1608940000
ZQV 2.5/20	24 A	20	1908960000
Width			
ZAP/TW ZDU/ZPE 2.5N	2 mm	20	1933790000
ZEW 35	6 mm	20	9540000000
ZTA ZT2.5	5.1 mm	25	1827080000
ZTA ZT2.5/ZA	5.1 mm	25	1847600000
SDIS SL 0.6X3.5X100		1	1274660000
ZRH 1.5H/1	4.85 mm	1000	1678810000
ZRH 1.5H/2	4.85 mm	1000	1678800000
ZAD 9/4	6 mm	20	1934160000

Identification systems	
	(see assortment in catalogue 7)
	Marking tags
Note	
DEK 5/5 / WS 10/5	
2.5 mm ² wires with wire ferrules including the plastic collar only clampable with diameter-optimised collar (Order no. 1333100000, pack of 500).	

ZDU 2.5N/3AN

2.5 mm²

3 connections

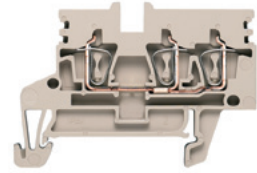

5.1 x 56.5 x 39
24 / 4
0.05...4

IEC 60947-7-1	II 2 G D	
IEC	UL	CSA
800	300 (C)	300 (C)
24	20 (C)	24 (C)
2.5	AWG 30...12	AWG 30...12
6 kV / 3		
A2 / V-0		
Rated connection		
0.5...4 / 1.5...2.5		
0.5...2.5 / 0.5...1.5		
10 / 0.6 x 3.5 mm		
2.5 mm ² flexible wires with wire-end ferrules are crimped with the Weidmüller PZ 6/5 crimping tool.		

Type	Qty.	Order No.
ZDU 2.5N/3AN	50	1933720000
ZDU 2.5N/3AN BL	50	1933730000

Type	current	Qty.	Order No.
ZQV 2.5/2	24 A	60	1608860000
ZQV 2.5/3	24 A	60	1608870000
ZQV 2.5/4	24 A	60	1608880000
ZQV 2.5/10	24 A	20	1608940000
ZQV 2.5/20	24 A	20	1908960000
Width			
ZAP/TW ZDU/ZPE 2.5N/3AN	2 mm	50	1933800000
ZEW 35	6 mm	20	9540000000
ZTA ZT2.5	5.1 mm	25	1827080000
ZTA ZT2.5/ZA	5.1 mm	25	1847600000
SDIS SL 0.6X3.5X100		1	1274660000
ZRH 1.5H/1	4.85 mm	1000	1678810000
ZRH 1.5H/2	4.85 mm	1000	1678800000
ZAD 9/4	6 mm	20	1934160000

Identification systems	
	(see assortment in catalogue 7)
	Marking tags
Note	
DEK 5/5 / WS 10/5	
2.5 mm ² wires with wire ferrules including the plastic collar only clampable with diameter-optimised collar (Order no. 1333100000, pack of 500).	

ZDU 2.5N/4AN

2.5 mm²

4 connections

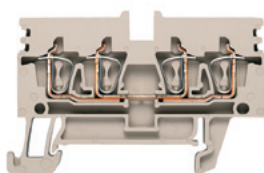

5.1 x 60 x 39
24 / 4
0.05...4



IEC 60947-7-1

II 2 G D

IEC	UL	CSA
800	300 (C)	300 (C)
24	20 (C)	24 (C)
2.5	AWG 30...12	AWG 30...12
6 kV / 3		
A2 / V-0		



Rated connection

0.5...4 / 1.5...2.5
 0.5...2.5 / 0.5...1.5
 10 / 0.6 x 3.5 mm

2.5 mm² flexible wires with wire-end ferrules are crimped with the Weidmüller PZ 6/5 crimping tool.

Type	Qty.	Order No.
ZDU 2.5N/4AN	50	1933740000
ZDU 2.5N/4AN BL	50	1933750000

Type	current	Qty.	Order No.
ZQV 2.5/2	24 A	60	1608860000
ZQV 2.5/3	24 A	60	1608870000
ZQV 2.5/4	24 A	60	1608880000
ZQV 2.5/10	24 A	20	1608940000
ZQV 2.5/20	24 A	20	1908960000
Width			
ZAP/TW ZDU/ZPE 2.5N/4AN	2 mm	50	1933810000
ZEW 35	6 mm	20	9540000000
ZTA ZT2.5	5.1 mm	25	1827080000
ZTA ZT2.5/ZA	5.1 mm	25	1847600000
SDIS SL 0.6X3.5X100		1	1274660000
ZRH 1.5H/1	4.85 mm	1000	1678810000
ZRH 1.5H/2	4.85 mm	1000	1678800000
ZAD 9/4	6 mm	20	1934160000

DEK 5/5 / WS 10/5

2.5 mm² wires with wire ferrules including the plastic collar only clampable with diameter-optimised collar (Order no. 1333100000, pack of 500).

Double- / Multi-level terminals

Standard form

Z-series standard ranges provide solutions for conductor cross-sections from 0.05 to 35 mm².

In hazardous area applications, the installation instructions and the rated data specifications for accessories given in the technical appendix must be followed.

Width/Length/Height of lowest version	mm
max. current / max. cond. cross-section	A/mm ²
Max. clamping range	mm ²

Technical data

Rated data	
Rated voltage	V
Rated current	A
Rated cross-section	mm ²
Rated impulse withstand voltage / Pollution severity	
Gauge to IEC 60947-1 / Flammability class UL94	
Approvals	
Clamped conductors (H05V/H07V)	
Solid / stranded	mm ²
Flexible / Flexible with ferrule	mm ²
Stripping length / Blade size	mm/-
Note	

Ordering data

Version	
	Dark beige Wemid
	Blue Wemid
Note	

Accessories

Pluggable cross-connection	
	1.5-pole
	2-pole
	3-pole
	4-pole
	10-pole
	20-/24-pole
End plate / Partition plate	
	Dark beige Wemid
	Blue Wemid
End bracket	
	Dark beige Wemid
Test adapter	
	Standard
	With assembly peg
Screwdriver	
	Standard
	With "swifty set" cutting device
Reducing sleeves	
	For conductors < 0.5 mm ² / AWG 20
	For conductors < 1.0 mm ² / AWG 18
Identification systems	
	(see assortment in catalogue 7)
	Marking tags
Note	

ZDK 1.5

1.5 mm²

Double-level terminal

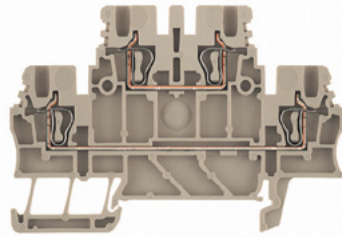

3.5 x 75.5 x 50	
17.5 / 1.5	
0.05...1.5	

IEC 60947-7-1

IEC	UL	CSA
500	300 (D)	600 (C)
17.5	10 (D)	10 (C)
1.5	AWG 28...16	AWG 28...16
6 kV / 3		
B1 / V-0		
Rated connection		
0.5...1.5		
0.5...1.5 / 0.5...1.5		
10 / 0.4 x 2.0 mm		

Type	Qty.	Order No.
ZDK 1.5	100	1791100000
ZDK 1.5 BL	100	1791110000

Type	current	Qty.	Order No.
ZQV 1.5/2	17.5 A	60	1776120000
ZQV 1.5/3	17.5 A	60	1776130000
ZQV 1.5/4	17.5 A	60	1776140000
ZQV 1.5/10	17.5 A	20	1776200000
Width			
ZAP/TW ZDK1.5	2 mm	20	1791160000
ZAP/TW ZDK1.5 BL	2 mm	20	1791170000
ZEW 35	6 mm	20	9540000000
ZTA 5	3.5 mm	25	1776210000
ZTA 5/ZA	3.5 mm	25	1776220000
SDS 0.4X2.0X60		1	9037160000
ZRH 1.5S/1	4.55 mm	500	1781950000
ZRH 1.5S/2	4.55 mm	500	1781960000

Note	
	DEK 5/3,5

ZDK 1.5V

1.5 mm²

Vertically cross-connected double-level terminal

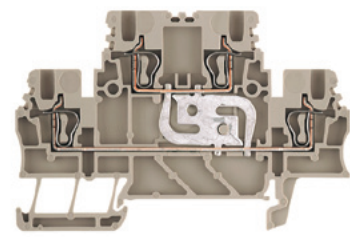

3.5 x 75.5 x 50	
17.5 / 1.5	
0.05...1.5	

IEC 60947-7-1

IEC	UL	CSA
500	300 (D)	600 (C)
17.5	10 (D)	10 (C)
1.5	AWG 28...16	AWG 28...16
6 kV / 3		
B1 / V-0		
Rated connection		
0.5...1.5		
0.5...1.5 / 0.5...1.5		
10 / 0.4 x 2.0 mm		

Type	Qty.	Order No.
ZDK 1.5V	100	1791130000
ZDK 1.5V BL	100	1791140000

Type	current	Qty.	Order No.
ZQV 1.5/2	17.5 A	60	1776120000
ZQV 1.5/3	17.5 A	60	1776130000
ZQV 1.5/4	17.5 A	60	1776140000
ZQV 1.5/10	17.5 A	20	1776200000
Width			
ZAP/TW ZDK1.5	2 mm	20	1791160000
ZAP/TW ZDK1.5 BL	2 mm	20	1791170000
ZEW 35	6 mm	20	9540000000
ZTA 5	3.5 mm	25	1776210000
ZTA 5/ZA	3.5 mm	25	1776220000
SDS 0.4X2.0X60		1	9037160000
ZRH 1.5S/1	4.55 mm	500	1781950000
ZRH 1.5S/2	4.55 mm	500	1781960000

Note	
	DEK 5/3,5

ZDK 1.5 DU-PE

1.5 mm²

Double-level terminals (DU - PE)

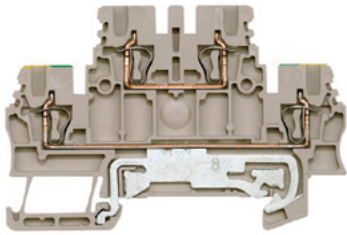

3.5 x 75.5 x 50
17.5 / 1.5
0.05...1.5

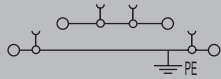

IEC 60947-7-1 (-7-2)

IEC	UL	CSA
500	300 (D)	
17.5	10 (D)	
1.5	AWG 28...16	AWG 28...16
6 kV / 3		
B1 / V-0		



Rated connection

0.5...1.5
 0.5...1.5 / 0.5...1.5
 10 / 0.4 x 2.0 mm

Type	Qty.	Order No.
ZDK 1.5DU-PE	100	1791120000

Upper level: feed-through terminal
 Lower level: PE terminal

Type	current	Qty.	Order No.
ZQV 1.5/2	17.5 A	60	1776120000
ZQV 1.5/3	17.5 A	60	1776130000
ZQV 1.5/4	17.5 A	60	1776140000
ZQV 1.5/10	17.5 A	20	1776200000
Width			
ZAP/TW ZDK1.5	2 mm	20	1791160000
ZAP/TW ZDK1.5 BL	2 mm	20	1791170000
ZEW 35	6 mm	20	9540000000
ZTA 5	3.5 mm	25	1776210000
ZTA 5/ZA	3.5 mm	25	1776220000
SDS 0.4X2.0X60		1	9037160000
ZRH 1.5S/1	4.55 mm	500	1781950000
ZRH 1.5S/2	4.55 mm	500	1781960000

DEK 5/3,5

Double- / Multi-level terminals

Standard form

Z-series standard ranges provide solutions for conductor cross-sections from 0.05 to 35 mm².

In hazardous area applications, the installation instructions and the rated data specifications for accessories given in the technical appendix must be followed.

Width/Length/Height of lowest version	mm
max. current / max. cond. cross-section	A/mm ²
Max. clamping range	mm ²

Technical data

Rated data	
Rated voltage	V
Rated current	A
Rated cross-section	mm ²
Rated impulse withstand voltage / Pollution severity	
Gauge to IEC 60947-1 / Flammability class UL94	
Approvals	
Clamped conductors (H05V/H07V)	
Solid / stranded	mm ²
Flexible / Flexible with ferrule	mm ²
Stripping length / Blade size	mm/-
Note	

Ordering data

Version	
	Dark beige Wemid
	Blue Wemid
Note	

Accessories

Pluggable cross-connection	
	1.5-pole
	2-pole
	3-pole
	4-pole
	10-pole
	20-/24-pole
End plate / Partition plate	
	Dark beige Wemid
	Blue Wemid
End bracket	
	Dark beige Wemid
Test adapter	
	Standard
	With assembly peg
Screwdriver	
	Standard
	With "swifty set" cutting device
Reducing sleeves	
	For conductors < 0.5 mm ² / AWG 20
	For conductors < 1.0 mm ² / AWG 18

Identification systems	(see assortment in catalogue 7)
	Marking tags
Note	

ZDK 2.5

2.5 mm²

Double-level terminal

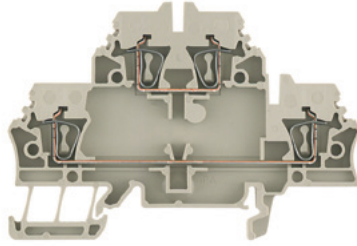

5.1 x 79.5 x 54	
20 / 2.5	
0.05...2.5	

IEC 60947-7-1	Ex e II	Ex	II 2 G D
IEC	UL	CSA	EN 60079-7
500	300 (C)	300 (C)	275
20	15 (C)	25 (C)	18
2.5	AWG 26...14	AWG 26...12	2.5
6 kV / 3			
A2 / V-0			
KEMA 97ATEX4677 U			
Rated connection			
0.5...2.5			
0.5...2.5 / 0.5...2.5			
10 / 0.6 x 3.5 mm			
2.5 mm ² flexible wires with wire-end ferrules are crimped with the Weidmüller PZ 6/5 crimping tool.			

Type	Qty.	Order No.
ZDK 2.5	50	1674300000
ZDK 2.5 BL	50	1678630000
ZBS 1 component plug ZBS 1 can be used for LED (1764550000).		

Type	current	Qty.	Order No.
ZQV 2.5/2	24 A	60	1608860000
ZQV 2.5/3	24 A	60	1608870000
ZQV 2.5/4	24 A	60	1608880000
ZQV 2.5/10	24 A	20	1608940000
ZQV 2.5/20	24 A	20	1908960000
Width			
ZAP/TW ZDK2.5	1.5 mm	20	1674730000
ZAP/TW ZDK2.5 BL	1.5 mm	20	1748800000
ZEW 35	6 mm	20	9540000000
ZTA 4	5.1 mm	25	1688110000
SDIS SL 0.6X3.5X100		1	1274660000
ZRH 1.5H/1	4.85 mm	1000	1678810000
ZRH 1.5H/2	4.85 mm	1000	1678800000

DEK 5/5 / WS 12/5
ZVQ 2.5/15 (1720700000) connects two busbars, one above the other.

ZDK 2.5 V

2.5 mm²

Vertically cross-connected double-level terminal

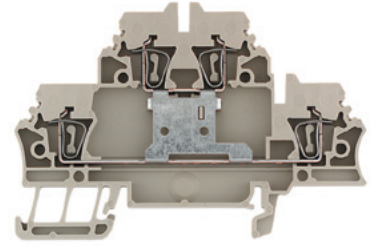

5.1 x 79.5 x 54	
20 / 2.5	
0.05...2.5	

IEC 60947-7-1	Ex e II	Ex	II 2 G D
IEC	UL	CSA	EN 60079-7
500	300 (C)	300 (D)	275
20	15 (C)	10 (D)	20
2.5	AWG 26...14	AWG 26...12	2.5
6 kV / 3			
A2 / V-0			
KEMA 97ATEX4677 U			
Rated connection			
0.5...2.5			
0.5...2.5 / 0.5...2.5			
10 / 0.6 x 3.5 mm			
2.5 mm ² flexible wires with wire-end ferrules are crimped with the Weidmüller PZ 6/5 crimping tool.			

Type	Qty.	Order No.
ZDK 2.5V	50	1689990000
ZDK 2.5V BL	50	1745880000

Type	current	Qty.	Order No.
ZQV 2.5/2	24 A	60	1608860000
ZQV 2.5/3	24 A	60	1608870000
ZQV 2.5/4	24 A	60	1608880000
ZQV 2.5/10	24 A	20	1608940000
ZQV 2.5/20	24 A	20	1908960000
Width			
ZAP/TW ZDK2.5	1.5 mm	20	1674730000
ZAP/TW ZDK2.5 BL	1.5 mm	20	1748800000
ZEW 35	6 mm	20	9540000000
ZTA 4	5.1 mm	25	1688110000
SDIS SL 0.6X3.5X100		1	1274660000
ZRH 1.5H/1	4.85 mm	1000	1678810000
ZRH 1.5H/2	4.85 mm	1000	1678800000

DEK 5/5 / WS 10/5

ZDK 2.5 DU-PE

2.5 mm²

Phase - PE conductor

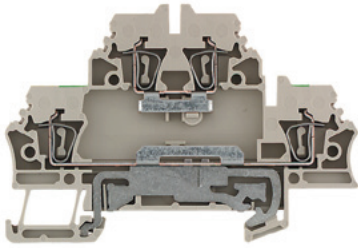

5.1 x 79.5 x 54
24 / 2.5
0.05...2.5

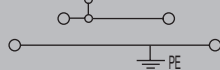

IEC 60947-7-1 (-7-2)

Ex e II II 2 G D

IEC	UL	CSA	EN 60079-7
500	300 (C)	300 (D)	275
20	15 (C)	10 (D)	20
2.5	AWG 26...14	AWG 26...12	2.5

6 kV / 3
A2 / V-0

KEMA 97ATEX4677 U

Rated connection

0.5...2.5
0.5...2.5 / 0.5...2.5
10 / 0.6 x 3.5 mm

2.5 mm² flexible wires with wire-end ferrules are crimped with the Weidmüller PZ 6/5 crimping tool.

Type	Qty.	Order No.
ZDK 2.5DU-PE	50	1689970000

Type	current	Qty.	Order No.
ZQV 2.5/2	24 A	60	1608860000
ZQV 2.5/3	24 A	60	1608870000
ZQV 2.5/4	24 A	60	1608880000
ZQV 2.5/10	24 A	20	1608940000
ZQV 2.5/20	24 A	20	1908960000
Width			
ZAP/TW ZDK2.5	1.5 mm	20	1674730000
ZAP/TW ZDK2.5 BL	1.5 mm	20	1748800000
ZEW 35	6 mm	20	9540000000
ZTA 4	5.1 mm	25	1688110000
SDIS SL 0.6X3.5X100		1	1274660000
ZRH 1.5H/1	4.85 mm	1000	1678810000
ZRH 1.5H/2	4.85 mm	1000	1678800000

DEK 5/5 / WS 12/5

ZDK 2.5 N-DU

2.5 mm²

Neutral conductor - phase

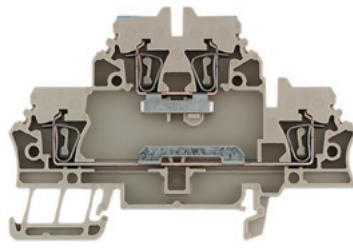

5.1 x 79.5 x 54
23 / 2.5
0.05...2.5

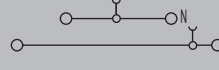

IEC 60947-7-1

Ex e II II 2 G D

IEC	UL	CSA	EN 60079-7
500	300 (C)	300 (D)	275
20	15 (C)	10 (D)	20
2.5	AWG 26...14	AWG 26...12	2.5

6 kV / 3
A2 / V-0

KEMA 97ATEX4677 U

Rated connection

0.5...2.5
0.5...2.5 / 0.5...2.5
10 / 0.6 x 3.5 mm

2.5 mm² flexible wires with wire-end ferrules are crimped with the Weidmüller PZ 6/5 crimping tool.

Type	Qty.	Order No.
ZDK 2.5N-DU	50	1689960000

Type	current	Qty.	Order No.
ZQV 2.5/2	24 A	60	1608860000
ZQV 2.5/3	24 A	60	1608870000
ZQV 2.5/4	24 A	60	1608880000
ZQV 2.5/10	24 A	20	1608940000
ZQV 2.5/20	24 A	20	1908960000
Width			
ZAP/TW ZDK2.5	1.5 mm	20	1674730000
ZAP/TW ZDK2.5 BL	1.5 mm	20	1748800000
ZEW 35	6 mm	20	9540000000
ZTA 4	5.1 mm	25	1688110000
SDIS SL 0.6X3.5X100		1	1274660000
ZRH 1.5H/1	4.85 mm	1000	1678810000
ZRH 1.5H/2	4.85 mm	1000	1678800000

DEK 5/5 / WS 12/5

ZDK 2.5 N-PE

2.5 mm²

Neutral & PE conductor

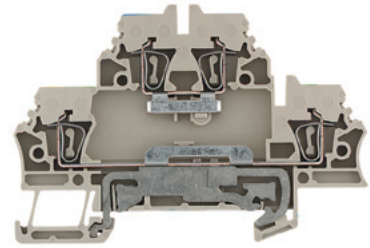

5.1 x 79.5 x 54
24 / 2.5
0.05...2.5



IEC 60947-7-1 (-7-2)

Ex e II II 2 G D

IEC	UL	CSA	EN 60079-7
500	300 (C)	300 (D)	275
20	15 (C)	10 (D)	20
2.5	AWG 26...14	AWG 26...12	2.5

6 kV / 3
A2 / V-0

KEMA 97ATEX4677 U

Rated connection

0.5...2.5
0.5...2.5 / 0.5...2.5
10 / 0.6 x 3.5 mm

2.5 mm² flexible wires with wire-end ferrules are crimped with the Weidmüller PZ 6/5 crimping tool.

Type	Qty.	Order No.
ZDK 2.5N-PE	50	1689980000

Type	current	Qty.	Order No.
ZQV 2.5/2	24 A	60	1608860000
ZQV 2.5/3	24 A	60	1608870000
ZQV 2.5/4	24 A	60	1608880000
ZQV 2.5/10	24 A	20	1608940000
ZQV 2.5/20	24 A	20	1908960000
Width			
ZAP/TW ZDK2.5	1.5 mm	20	1674730000
ZAP/TW ZDK2.5 BL	1.5 mm	20	1748800000
ZEW 35	6 mm	20	9540000000
ZTA 4	5.1 mm	25	1688110000
SDIS SL 0.6X3.5X100		1	1274660000
ZRH 1.5H/1	4.85 mm	1000	1678810000
ZRH 1.5H/2	4.85 mm	1000	1678800000

DEK 5/5 / WS 12/5

Double- / Multi-level terminals

Standard form

Z-series standard ranges provide solutions for conductor cross-sections from 0.05 to 35 mm².

In hazardous area applications, the installation instructions and the rated data specifications for accessories given in the technical appendix must be followed.

Width/Length/Height of lowest version	mm
max. current / max. cond. cross-section	A/mm ²
Max. clamping range	mm ²

Technical data

Rated data	
Rated voltage	V
Rated current	A
Rated cross-section	mm ²
Rated impulse withstand voltage / Pollution severity	
Gauge to IEC 60947-1 / Flammability class UL94	
Approvals	
Clamped conductors (H05V/H07V)	
Solid / stranded	mm ²
Flexible / Flexible with ferrule	mm ²
Stripping length / Blade size	mm/-
Note	

Ordering data

Version	
	Dark beige Wemid
	Blue Wemid
Note	

Accessories

Pluggable cross-connection	
	1.5-pole
	2-pole
	3-pole
	4-pole
	10-pole
	20-/24-pole
End plate / Partition plate	
	Dark beige Wemid
	Blue Wemid
End bracket	
	Dark beige Wemid
Test adapter	
	Standard
	With assembly peg
Screwdriver	
	Standard
	With "swifty set" cutting device
Reducing sleeves	
	For conductors < 0.5 mm ² / AWG 20
	For conductors < 1.0 mm ² / AWG 18

Identification systems	
	(see assortment in catalogue 7)
	Marking tags
Note	

ZDLD 2.5-2 N

2.5 mm²

Three levels

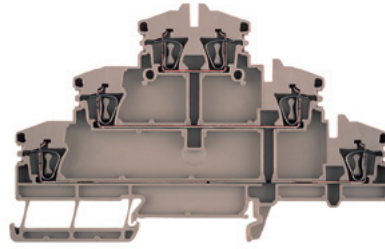

5.1 x 110.5 x 70	
20 / 2.5	
0.13...2.5	

IEC 60947-7-1

IEC	UL	CSA
500	300 (D)	300 (D)
20	10 (D)	10 (D)
2.5	AWG 26...12	AWG 26...12
6 kV / 3		
A2 / V-0		
Rated connection		
0.5...2.5		
0.5...2.5 / 0.5...2.5		
10 / 0.6 x 3.5 mm		
2.5 mm ² flexible wires with wire-end ferrules are crimped with the Weidmüller PZ 6/5 crimping tool.		

Type	Qty.	Order No.
ZDLD 2.5-2N	50	1782300000
ZDLD 2.5-2N BL	50	1782310000

Type	current	Qty.	Order No.
ZVQ 2.5/1.5	23 A	50	1720700000
ZVQ 2.5/2	24 A	60	1608860000
ZVQ 2.5/3	24 A	60	1608870000
ZVQ 2.5/4	24 A	60	1608880000
ZVQ 2.5/10	24 A	20	1608940000
ZVQ 2.5/20	24 A	20	1908960000
Width			
ZAP/TW ZDLD2.5-2N	1.5 mm	20	1782340000
ZAP/TW ZDLD2.5-2N BL	1.5 mm	20	1782350000
ZEW 35	6 mm	20	9540000000
ZTA 4			
SDIS SL 0.6X3.5X100		1	1274660000
SWIFTY SET	18 mm	1	9006060000
ZRH 1.5H/1	4.85 mm	1000	1678810000
ZRH 1.5H/2	4.85 mm	1000	1678800000

Identification systems	
	(see assortment in catalogue 7)
	Marking tags
Note	
	DEK 5/5 / WS 12/5
	ZVQ 2.5/15 (1720700000) connects two busbars, one above the other.

ZDLD 2.5-2 VN

2.5 mm²

Vertically cross-connected multi-level terminal

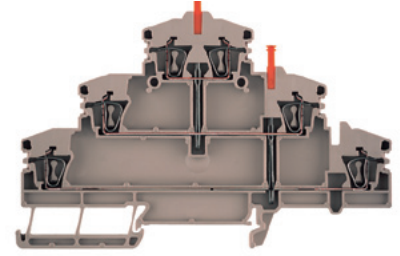

5.1 x 110.5 x 70	
20 / 2.5	
0.13...2.5	

IEC 60947-7-1

IEC	UL	CSA
400	300 (D)	300 (D)
20	10 (D)	10 (D)
2.5	AWG 26...12	AWG 26...12
6 kV / 3		
A2 / V-0		
Rated connection		
0.5...2.5		
0.5...2.5 / 0.5...2.5		
10 / 0.6 x 3.5 mm		
2.5 mm ² flexible wires with wire-end ferrules are crimped with the Weidmüller PZ 6/5 crimping tool.		

Type	Qty.	Order No.
ZDLD 2.5-2VN	25	1782320000
ZDLD 2.5-2VN BL	25	1782330000

Type	current	Qty.	Order No.
ZVQ 2.5/2	24 A	60	1608860000
ZVQ 2.5/3	24 A	60	1608870000
ZVQ 2.5/4	24 A	60	1608880000
ZVQ 2.5/10	24 A	20	1608940000
ZVQ 2.5/20	24 A	20	1908960000
Width			
ZAP/TW ZDLD2.5-2N	1.5 mm	20	1782340000
ZAP/TW ZDLD2.5-2N BL	1.5 mm	20	1782350000
ZEW 35	6 mm	20	9540000000
ZTA 4			
SDIS SL 0.6X3.5X100		1	1274660000
SWIFTY SET	18 mm	1	9006060000
ZRH 1.5H/1	4.85 mm	1000	1678810000
ZRH 1.5H/2	4.85 mm	1000	1678800000

Identification systems	
	(see assortment in catalogue 7)
	Marking tags
Note	
	DEK 5/5 / WS 12/5

ZDLD 2.5-2 N PE/L/L

2.5 mm²

NEW

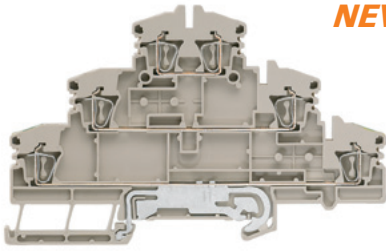

5.1 x 110.5 x 70
/ 2.5
0.08...2.5

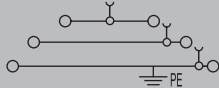

IEC	UL	CSA
500	150 (C)	150 (C)
20	15 (C)	15 (C)
2.5	AWG 26...12	AWG 26...12
6 kV / 3		
A2 / V-0		

UL	
Rated connection	
0.5...2.5	
0.5...2.5 / 0.5...1.5	
10 / 0.6 x 3.5 mm	

Type	Qty.	Order No.
ZDLD 2.5-2N/PE/L/L	50	1131750000

Type	current	Qty.	Order No.
ZVQ 2.5/1.5	23 A	50	1720700000
ZQV 2.5/2	24 A	60	1608860000
ZQV 2.5/3	24 A	60	1608870000
ZQV 2.5/4	24 A	60	1608880000
ZQV 2.5/10	24 A	20	1608940000
Width			
ZAP/TW ZDLD2.5-2N	1.5 mm	20	1782340000
ZAP/TW ZDLD2.5-2N BL	1.5 mm	20	1782350000
ZEW 35	6 mm	20	9540000000
ZTA 4	5.1 mm	25	1688110000
SDIS SL 0.6X3.5X100		1	1274660000
SWIFTY SET	18 mm	1	9006060000
ZRH 1.5H/1	4.85 mm	1000	1678810000
ZRH 1.5H/2	4.85 mm	1000	1678800000

DEK 5/5 / WS 12/5

ZDLD 2.5-2 N PE/L/N

2.5 mm²

NEW

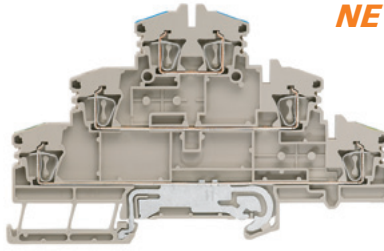

5.1 x 110.5 x 70
/ 2.5
0.08...2.5

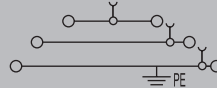

IEC	UL	CSA
500	150 (C)	150 (C)
20	15 (C)	15 (C)
2.5	AWG 26...12	AWG 26...12
6 kV / 3		
A2 / V-0		

UL	
Rated connection	
0.5...2.5	
0.5...2.5 / 0.5...1.5	
10 / 0.6 x 3.5 mm	

Type	Qty.	Order No.
ZDLD 2.5-2N/PE/L/N	50	1131760000

Type	current	Qty.	Order No.
ZVQ 2.5/1.5	23 A	50	1720700000
ZQV 2.5/2	24 A	60	1608860000
ZQV 2.5/3	24 A	60	1608870000
ZQV 2.5/4	24 A	60	1608880000
ZQV 2.5/10	24 A	20	1608940000
ZQV 2.5/20	24 A	20	1908960000
Width			
ZAP/TW ZDLD2.5-2N	1.5 mm	20	1782340000
ZAP/TW ZDLD2.5-2N BL	1.5 mm	20	1782350000
ZEW 35	6 mm	20	9540000000
ZTA 4	5.1 mm	25	1688110000
SDIS SL 0.6X3.5X100		1	1274660000
SWIFTY SET	18 mm	1	9006060000
ZRH 1.5H/1	4.85 mm	1000	1678810000
ZRH 1.5H/2	4.85 mm	1000	1678800000

DEK 5/5 / WS 12/5

ZDLD 2.5-2 N PE

2.5 mm²

NEW

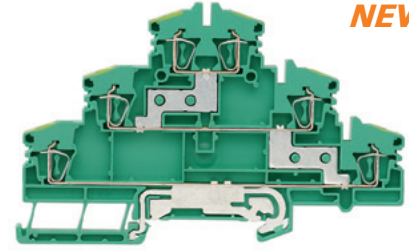

5.1 x 110.5 x 70
/ 2.5
0.08...2.5

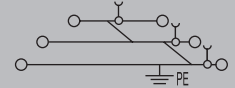

IEC	UL	CSA
500		
20		
2.5	AWG 26...12	AWG 26...12
6 kV / 3		
A2 / V-0		

UL	
Rated connection	
0.5...2.5	
0.5...2.5 / 0.5...1.5	
10 / 0.6 x 3.5 mm	

Type	Qty.	Order No.
ZDLD 2.5-2N PE	50	1131740000

Type	current	Qty.	Order No.
ZVQ 2.5/1.5	23 A	50	1720700000
ZQV 2.5/2	24 A	60	1608860000
ZQV 2.5/3	24 A	60	1608870000
ZQV 2.5/4	24 A	60	1608880000
ZQV 2.5/10	24 A	20	1608940000
ZQV 2.5/20	24 A	20	1908960000
Width			
ZAP/TW ZDLD2.5-2N	1.5 mm	20	1782340000
ZAP/TW ZDLD2.5-2N BL	1.5 mm	20	1782350000
ZEW 35	6 mm	20	9540000000
ZTA 4	5.1 mm	25	1688110000
SDIS SL 0.6X3.5X100		1	1274660000
SWIFTY SET	18 mm	1	9006060000
ZRH 1.5H/1	4.85 mm	1000	1678810000
ZRH 1.5H/2	4.85 mm	1000	1678800000

DEK 5/5 / WS 12/5

Double- / Multi-level terminals

Standard form

ZVLD 2.5

2.5 mm²

NEW

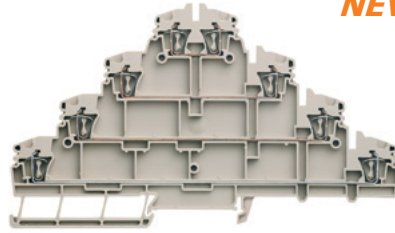

In hazardous area applications, the installation instructions and the rated data specifications for accessories given in the technical appendix must be followed.

Width/Length/Height of lowest version	mm
max. current / max. cond. cross-section	A/mm ²
Max. clamping range	mm ²

5.1 x 148 x 86	
/ 2.5	
0.14...2.5	

Technical data

Rated data	
Rated voltage	V
Rated current	A
Rated cross-section	mm ²
Rated impulse withstand voltage / Pollution severity	
Gauge to IEC 60947-1 / Flammability class UL94	
Approvals	
Clamped conductors (H05V/H07V)	
Solid / stranded	mm ²
Flexible / Flexible with ferrule	mm ²
Stripping length / Blade size	mm/-

IEC 60947-7-1		
IEC	UL	CSA
250		
24		
2.5		
	6 kV / 3	
	/ V-0	
Rated connection		
0.5...2.5 / 0.5...2.5		
0.5...2.5 / 0.5...2.5		

Note

Ordering data

Version	
	Dark beige Wemid
	Blue Wemid
Note	

Type	Qty.	Order No.
ZVLD 2.5	50	1208920000

Accessories

Pluggable cross-connection	
	1.5-pole
	2-pole
	3-pole
	4-pole
	10-pole
	20-/24-pole
End plate / Partition plate	
	Dark beige Wemid
	Blue Wemid
End bracket	
	Dark beige Wemid
Test adapter	
	Standard
	With assembly peg
Screwdriver	
	Standard
	With "swifty set" cutting device
Reducing sleeves	
	For conductors < 0.5 mm ² / AWG 20
	For conductors < 1.0 mm ² / AWG 18

Type	current	Qty.	Order No.
ZVQ 2.5/1.5	23 A	50	1720700000
ZQV 2.5/2	24 A	60	1608860000
ZQV 2.5/3	24 A	60	1608870000
ZQV 2.5/4	24 A	60	1608880000
ZQV 2.5/10	24 A	20	1608940000
ZQV 2.5/20	24 A	20	1908960000
Width			
ZAP ZVLD 2.5	1.5 mm	10	1210410000
ZEW 35/2	8 mm	20	8630740000
ZTA ZVLD	5.1 mm	50	1210390000
ZTA ZVLD/ZA	5.1 mm	50	1271870000

Identification systems	
	(see assortment in catalogue 7)
	Marking tags
Note	

DEK 5/5

Double- / Multi-level terminals

Roof-style

The compact terminal range for conductor cross-sections 0.13 to 16 mm²

In hazardous area applications, the installation instructions and the rated data specifications for accessories given in the technical appendix must be followed.

Width/Length/Height of lowest version	mm
max. current / max. cond. cross-section	A/mm ²
Max. clamping range	mm ²

Technical data

Rated data	
Rated voltage	V
Rated current	A
Rated cross-section	mm ²
Rated impulse withstand voltage / Pollution severity	
Gauge to IEC 60947-1 / Flammability class UL94	
Approvals	
Clamped conductors (H05V/H07V)	
Solid / stranded	mm ²
Flexible / Flexible with ferrule	mm ²
Stripping length / Blade size	mm/-

Note

Ordering data

Version	
	Dark beige Wemid
	Blue Wemid

Note

Accessories

Pluggable cross-connection	
	2-pole
	3-pole
	4-pole
	10-pole
	20-/24-pole
End plate / Partition plate	
	Dark beige Wemid
	Blue Wemid
End bracket	
	Dark beige Wemid
Test adapter	
	With assembly peg
Screwdriver	
	Standard
	With "swifty set" cutting device
Reducing sleeves	
	For conductors < 0.5 mm ² / AWG 20
	For conductors < 1.0 mm ² / AWG 18
Cover	
	With lightning flash symbol

Identification systems	
(see assortment in catalogue 7)	
Marking tags	

Note

ZDK 2.5-2

2.5 mm²

Double-level terminal

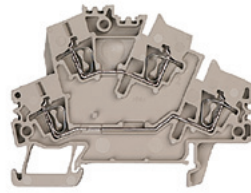

5.1 x 72.5 x 55.5
24 / 4
0.05...4

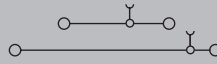

IEC 60947-7-1

II 2 G D

IEC	UL	CSA
800	600 (C)	600 (C)
24	20 (C)	25 (C)
2.5	AWG 30...12	AWG 30...12
8 kV / 3		
A2 / V-0		

Rated connection

0.5...4
0.5...2.5 / 0.5...2.5
10 / 0.6 x 3.5 mm

2.5 mm² flexible wires with wire-end ferrules are crimped with the Weidmüller PZ 6/5 crimping tool.

Type	Qty.	Order No.
ZDK 2.5-2	50	1790990000
ZDK 2.5-2 BL	50	1791000000

The rated voltage is reduced to 400 V when using the cross-connection.

Type	current	Qty.	Order No.
ZQV 2.5/2	24 A	60	1608860000
ZQV 2.5/3	24 A	60	1608870000
ZQV 2.5/4	24 A	60	1608880000
ZQV 2.5/10	24 A	20	1608940000
ZQV 2.5/20	24 A	20	1908960000
Width			
ZAP/TW ZDK2.5-2	2 mm	20	1791050000
ZAP/TW ZDK2.5-2 BL	2 mm	20	1791060000
ZEW 35	6 mm	20	9540000000
ZTA 4	5.1 mm	25	1688110000
SDIS SL 0.6X3.5X100		1	1274660000
ZRH 1.5H/1	4.85 mm	1000	1678810000
ZRH 1.5H/2	4.85 mm	1000	1678800000
ZAD 1/4-2 GE	8 mm	20	1764560000

DEK 5/5 / WS 10/5
ZDK 2.5-2/LD 24VUC order number 1905310000

ZDK 2.5-2V

2.5 mm²

Vertical cross-connected double-level terminal



5.1 x 72.5 x 55.5
24 / 4
0.05...4

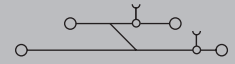

IEC 60947-7-1

II 2 G D

IEC	UL	CSA
800	600 (C)	300 (D)
24	20 (C)	10 (D)
2.5	AWG 30...12	AWG 30...12
8 kV / 3		
A2 / V-0		

Rated connection

0.5...4
0.5...2.5 / 0.5...2.5
10 / 0.6 x 3.5 mm

2.5 mm² flexible wires with wire-end ferrules are crimped with the Weidmüller PZ 6/5 crimping tool.

Type	Qty.	Order No.
ZDK 2.5-2V	50	1791030000
ZDK 2.5-2V BL	50	1791040000

The rated voltage is reduced to 400 V when using the cross-connection.

Type	current	Qty.	Order No.
ZQV 2.5/2	24 A	60	1608860000
ZQV 2.5/3	24 A	60	1608870000
ZQV 2.5/4	24 A	60	1608880000
ZQV 2.5/10	24 A	20	1608940000
ZQV 2.5/20	24 A	20	1908960000
Width			
ZAP/TW ZDK2.5-2	2 mm	20	1791050000
ZAP/TW ZDK2.5-2 BL	2 mm	20	1791060000
ZEW 35	6 mm	20	9540000000
ZTA 4	5.1 mm	25	1688110000
SDIS SL 0.6X3.5X100		1	1274660000
ZRH 1.5H/1	4.85 mm	1000	1678810000
ZRH 1.5H/2	4.85 mm	1000	1678800000
ZAD 1/4-2 GE	8 mm	20	1764560000

DEK 5/5 / WS 10/5

Roof-style

The compact terminal range for conductor cross-sections 0.13 to 16 mm²

In hazardous area applications, the installation instructions and the rated data specifications for accessories given in the technical appendix must be followed.

Width/Length/Height of lowest version	mm
max. current / max. cond. cross-section	A/mm ²
Max. clamping range	mm ²



Technical data

Rated data	
Rated voltage	V
Rated current	A
Rated cross-section	mm ²
Rated impulse withstand voltage / Pollution severity Gauge to IEC 60947-1 / Flammability class UL94	
Approvals	
Clamped conductors (H05V/H07V)	
Solid / stranded	mm ²
Flexible / Flexible with ferrule	mm ²
Stripping length / Blade size	mm/-
Note	

Ordering data

Version	
	Dark beige Wemid Blue Wemid
Note	

Accessories

Pluggable cross-connection	
	2-pole 3-pole 4-pole 10-pole 20-/24-pole
	
End plate / Partition plate	
	Dark beige Wemid Blue Wemid
End bracket	
	Dark beige Wemid
Test adapter	
	With assembly peg
Screwdriver	
	Standard With "swifty set" cutting device
Reducing sleeves	
	For conductors < 0.5 mm ² / AWG 20 For conductors < 1.0 mm ² / AWG 18
Cover	
	With lightning flash symbol
Identification systems (see assortment in catalogue 7)	
	Marking tags
Note	

ZDKPE 2.5-2

2.5 mm²

Double-tier terminal with one-sided PE connection

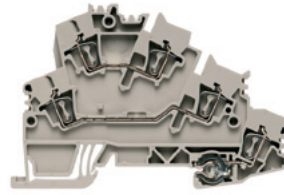

5.1 x 89.5 x 60.5
24 / 4
0.05...4

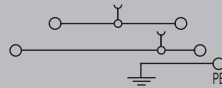

IEC 60947-7-1 (-7-2)

IEC	UL	CSA
800	600 (C)	300 (D)
24	20 (C)	10 (D)
2.5	AWG 26...12	AWG 30...12
8 kV / 3		
A2 / V-0		
		
Rated connection		
0.5...4		
0.5...2.5 / 0.5...2.5		
10 / 0.6 x 3.5 mm		
2.5 mm ² flexible wires with wire-end ferrules are crimped with the Weidmüller PZ 6/5 crimping tool.		

Type	Qty.	Order No.
ZDKPE 2.5-2	50	1805940000
The rated voltage is reduced to 400 V when using the cross-connection.		

Type	current	Qty.	Order No.
ZQV 2.5/2	24 A	60	1608860000
ZQV 2.5/3	24 A	60	1608870000
ZQV 2.5/4	24 A	60	1608880000
ZQV 2.5/10	24 A	20	1608940000
ZQV 2.5/20	24 A	20	1908960000
Width			
ZAP/TW ZDKPE2.5-2	2 mm	25	1805960000
ZEW 35			
	6 mm	20	9540000000
ZTA 4			
	5.1 mm	25	1688110000
SDIS SL 0.6X3.5X100			
		1	1274660000
SWIFTY SET			
	18 mm	1	9006060000
ZRH 1.5H/1			
	4.85 mm	1000	1678810000
ZRH 1.5H/2			
	4.85 mm	1000	1678800000
ZAD 1/4-2 GE			
	8 mm	20	1764560000

DEK 5/5 / WS 10/5

ZDKPE 2.5-2/N/L/PE

2.5 mm²

Double-tier terminal with one-sided PE connection

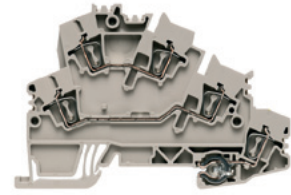

5.1 x 89.5 x 60.5
24 / 4
0.05...4

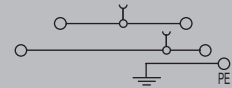

IEC 60947-7-1 (-7-2)

IEC	UL	CSA
800	600 (C)	
24	20 (C)	
2.5	AWG 26...12	
8 kV / 3		
A2 / V-0		
		
Rated connection		
0.5...4		
0.5...2.5 / 0.5...2.5		
10 / 0.6 x 3.5 mm		
2.5 mm ² flexible wires with wire-end ferrules are crimped with the Weidmüller PZ 6/5 crimping tool.		

Type	Qty.	Order No.
ZDKPE 2.5-2/N/L/PE	50	1895700000
The rated voltage is reduced to 400 V when using the cross-connection.		

Type	current	Qty.	Order No.
ZQV 2.5/2	24 A	60	1608860000
ZQV 2.5/3	24 A	60	1608870000
ZQV 2.5/4	24 A	60	1608880000
ZQV 2.5/10	24 A	20	1608940000
ZQV 2.5/20	24 A	20	1908960000
Width			
ZAP/TW ZDKPE2.5-2	2 mm	25	1805960000
ZEW 35			
	6 mm	20	9540000000
ZTA 4			
	5.1 mm	25	1688110000
SDIS SL 0.6X3.5X100			
		1	1274660000
SWIFTY SET			
	18 mm	1	9006060000
ZRH 1.5H/1			
	4.85 mm	1000	1678810000
ZRH 1.5H/2			
	4.85 mm	1000	1678800000
ZAD 1/4-2 GE			
	8 mm	20	1764560000

DEK 5/5 / WS 10/5

Double- / Multi-level terminals

Roof-style

In hazardous area applications, the installation instructions and the rated data specifications for accessories given in the technical appendix must be followed.

Width/Length/Height of lowest version	mm
max. current / max. cond. cross-section	A/mm ²
Max. clamping range	mm ²

Technical data

Rated data	
Rated voltage	V
Rated current	A
Rated cross-section	mm ²
Rated impulse withstand voltage / Pollution severity Gauge to IEC 60947-1 / Flammability class UL94	
Approvals	
Clamped conductors (H05V/H07V)	
Solid / stranded	mm ²
Flexible / Flexible with ferrule	mm ²
Stripping length / Blade size	mm/-
Note	

Ordering data

Version	
	Dark beige Wemid
	Blue Wemid
Note	

Accessories

Pluggable cross-connection	
	2-pole
	3-pole
	4-pole
	10-pole
	20-/24-pole
End plate / Partition plate	
	Dark beige Wemid
	Blue Wemid
End bracket	
	Dark beige Wemid
Test adapter	
	With assembly peg
Screwdriver	
	Standard
	With "swifty set" cutting device
Reducing sleeves	
	For conductors < 0.5 mm ² / AWG 20
	For conductors < 1.0 mm ² / AWG 18
Cover	
	With lightning flash symbol
Identification systems	
	(see assortment in catalogue 7)
	Marking tags
Note	

ZDK 4-2

4 mm²

Double-level terminal

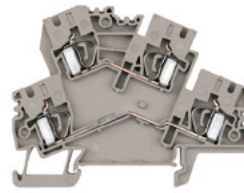

6.1 x 77.6 x 61	
32 / 6	
0.13...6	

IEC 60947-7-1

IEC	UL	CSA
800	600 (C)	600 (C)
32	25 (C)	30 (C)
4	AWG 26...10	AWG 26...10
8 kV / 3		
A3 / V-0		
Rated connection		
0.5...6		
0.5...4 / 0.5...4		
10 / 0.6 x 3.5 mm		

Type	Qty.	Order No.
ZDK 4-2	50	8670750000
ZDK 4-2 BL	50	8670850000

Type	current	Qty.	Order No.
ZQV 4/2 GE	32 A	60	1608950000
ZQV 4/3 GE	32 A	60	1608960000
ZQV 4/4 GE	32 A	60	1608970000
ZQV 4/10 GE	32 A	20	1609030000
ZQV 4/20 GE	32 A	20	1909010000
Width			
ZAP/TW ZDK4-2	2 mm	50	8670760000
ZAP/TW ZDK4-2 BL	2 mm	50	8670620000
ZEW 35	6 mm	20	9540000000
ZTA 6/ZA	6.1 mm	25	1780660000
SDIS SL 0.6X3.5X100		1	1274660000
ZAD 1/4	8 mm	20	1609110000

DEK 5/6

ZDK 4-2 V

4 mm²

Vertical cross-connected double-level terminal

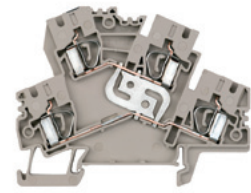

6.1 x 77.6 x 61	
32 / 6	
0.13...6	

IEC 60947-7-1

IEC	UL	CSA
800	600 (C)	600 (C)
32	25 (C)	30 (C)
4	AWG 26...10	AWG 26...10
8 kV / 3		
A3 / V-0		
Rated connection		
0.5...6		
0.5...4 / 0.5...4		
10 / 0.6 x 3.5 mm		

Type	Qty.	Order No.
ZDK 4-2 V	50	8671080000

Type	current	Qty.	Order No.
ZQV 4/2 GE	32 A	60	1608950000
ZQV 4/3 GE	32 A	60	1608960000
ZQV 4/4 GE	32 A	60	1608970000
ZQV 4/10 GE	32 A	20	1609030000
ZQV 4/20 GE	32 A	20	1909010000
Width			
ZAP/TW ZDK4-2	2 mm	50	8670760000
ZAP/TW ZDK4-2 BL	2 mm	50	8670620000
ZEW 35	6 mm	20	9540000000
ZTA 6/ZA	6.1 mm	25	1780660000
SDIS SL 0.6X3.5X100		1	1274660000
ZAD 1/4	8 mm	20	1609110000

DEK 5/6

ZDK 4-2 DU/PE

4 mm²

Phase - PE conductor



6.1 x 77.6 x 61
32 / 6
0.13...6

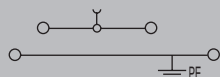

IEC 60947-7-1 (-7-2)

IEC	UL	CSA
800	600 (C)	600 (C)
32	25 (C)	30 (C)
4	AWG 26...10	AWG 26...10
8 kV / 3		
A3 / V-0		



Rated connection

0.5...6
0.5...4 / 0.5...4
10 / 0.6 x 3.5 mm

Type	Qty.	Order No.
ZDK 4-2/DU-PE	50	8671120000

Type	current	Qty.	Order No.
ZQV 4/2 GE	32 A	60	1608950000
ZQV 4/3 GE	32 A	60	1608960000
ZQV 4/4 GE	32 A	60	1608970000
ZQV 4/10 GE	32 A	20	1609030000
ZQV 4/20 GE	32 A	20	1909010000
Width			
ZAP/TW ZDK4-2	2 mm	50	8670760000
ZAP/TW ZDK4-2 BL	2 mm	50	8670620000
Width			
ZEW 35	6 mm	20	9540000000
ZTA 6/ZA	6.1 mm	25	1780660000
SDIS SL 0.6X3.5X100		1	1274660000
Width			
ZAD 1/4	8 mm	20	1609110000

DEK 5/6

ZDK 4-2/N/L

4 mm²

Double-level terminal



6.1 x 77.6 x 61
32 / 6
0.13...6

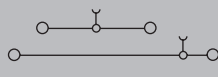

IEC 60947-7-1

IEC	UL	CSA
800	600 (C)	
32	25 (C)	
4	AWG 26...10	
8 kV / 3		
A3 / V-0		



Rated connection

0.5...6
0.5...4 / 0.5...4
10 / 0.6 x 3.5 mm

Type	Qty.	Order No.
ZDK 4-2/N/L	50	1905170000

Upper level printed blue

Type	current	Qty.	Order No.
ZQV 4/2 GE	32 A	60	1608950000
ZQV 4/3 GE	32 A	60	1608960000
ZQV 4/4 GE	32 A	60	1608970000
ZQV 4/10 GE	32 A	20	1609030000
ZQV 4/20 GE	32 A	20	1909010000
Width			
ZAP/TW ZDK4-2	2 mm	50	8670760000
ZAP/TW ZDK4-2 BL	2 mm	50	8670620000
Width			
ZEW 35	6 mm	20	9540000000
ZTA 6/ZA	6.1 mm	25	1780660000
SDIS SL 0.6X3.5X100		1	1274660000
Width			
ZAD 1/4	8 mm	20	1609110000

DEK 5/6

ZDK 4-2/2AN

4 mm²

NEW



8.1 x 78 x 61
/ 6
0.13...6



IEC	UL	CSA
800		
32		
4	AWG 26...10	
/ 3		
A3 / V-0		



Rated connection

0.5...6
0.5...4 / 0.5...4
10 / 0.6 x 3.5 mm

Type	Qty.	Order No.
ZDK 4-2/2AN	50	1119700000

Type	current	Qty.	Order No.
ZQV 4/2 GE	32 A	60	1608950000
ZQV 4/3 GE	32 A	60	1608960000
ZQV 4/4 GE	32 A	60	1608970000
ZQV 4/10 GE	32 A	20	1609030000
ZQV 4/20 GE	32 A	20	1909010000
Width			
ZAP/TW ZDK4-2	2 mm	50	8670760000
ZAP/TW ZDK4-2 BL	2 mm	50	8670620000
Width			
ZEW 35	6 mm	20	9540000000
ZTA 6/ZA	6.1 mm	25	1780660000
SDIS SL 0.6X3.5X100		1	1274660000
Width			
ZAD 1/4	8 mm	20	1609110000

DEK 5/6

Double- / Multi-level terminals

Compact style

In hazardous area applications, the installation instructions and the rated data specifications for accessories given in the technical appendix must be followed.

Width/Length/Height of lowest version	mm
max. current / max. cond. cross-section	A/mm ²
Max. clamping range	mm ²

Technical data

Rated data	
Rated voltage	V
Rated current	A
Rated cross-section	mm ²
Rated impulse withstand voltage / Pollution severity Gauge to IEC 60947-1 / Flammability class UL94	
Approvals	
Clamped conductors (H05V/H07V)	
Solid / stranded	mm ²
Flexible / Flexible with ferrule	mm ²
Stripping length / Blade size	mm/-
Note	

Ordering data

Version	
	Dark beige Wemid
	Blue Wemid
Note	

Accessories

Pluggable cross-connection	
	2-pole
	3-pole
	4-pole
	10-pole
	20-/24-pole
End plate / Partition plate	
	Dark beige Wemid
End bracket	
	Dark beige Wemid
Test adapter	
	Standard
	With assembly peg
Screwdriver	
	Standard
Reducing sleeves	
	For conductors < 0.5 mm ² / AWG 20
	For conductors < 1.0 mm ² / AWG 18
Cover	
	With lightning flash symbol
Identification systems	
	(see assortment in catalogue 7)
	Marking tags
Note	

ZDK 2.5/3AN

2.5 mm²

Double-level terminal

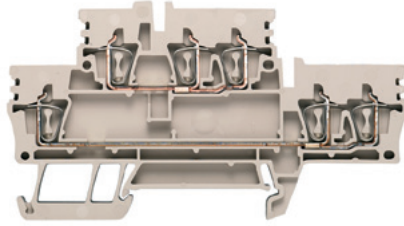

5.1 x 93 x 51.5	
24 / 4	
0.05...4	

IEC 60947-7-1 II 2 G D

IEC	UL	CSA
800	300 (C)	300 (C)
24	20 (C)	24 (C)
2.5	AWG 30...12	AWG 30...12
8 kV / 3		
A2 / V-0		

Rated connection	
0.5...4 / 0.5...2.5	
0.5...2.5 / 0.5...2.5	
10 / 0.6 x 3.5 mm	
2.5 mm ² flexible wires with wire-end ferrules are crimped with the Weidmüller PZ 6/5 crimping tool.	

Type	Qty.	Order No.
ZDK 2.5/3AN	50	1924510000
ZDK 2.5/3AN BL	50	1924500000
Diode versions ZDK 2.5/3AN D1, 1924440000 and ZDK 2.5/3AN D2, 1924450000.		

Type	current	Qty.	Order No.
ZQV 2.5/2	24 A	60	1608860000
ZQV 2.5/3	24 A	60	1608870000
ZQV 2.5/4	24 A	60	1608880000
ZQV 2.5/10	24 A	20	1608940000
ZQV 2.5/20	24 A	20	1908960000
Width			
ZAP/TW ZDK 2.5/3AN	1.5 mm	20	1924910000
ZEW 35	6 mm	20	9540000000
ZTA ZT2.5	5.1 mm	25	1827080000
ZTA ZT2.5/ZA	5.1 mm	25	1847600000
SDIS SL 0.6X3.5X100		1	1274660000
ZRH 1.5H/1	4.85 mm	1000	1678810000
ZRH 1.5H/2	4.85 mm	1000	1678800000
ZAD 9/4	6 mm	20	1934160000

SNAPMARK I / DEK 5/5 / WS 10/5	
2.5 mm ² wires with wire ferrules including the plastic collar only clampable with diameter-optimised collar (Order no. 1333100000, pack of 500).	

ZDK 2.5/3AN V

2.5 mm²

Vertical cross-connected double-level terminal

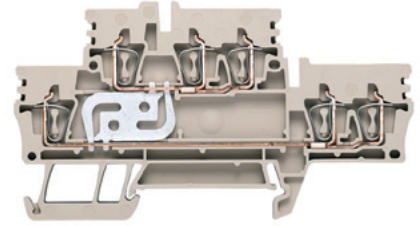

5.1 x 93 x 51.5	
24 / 4	
0.05...4	

IEC 60947-7-1 II 2 G D

IEC	UL	CSA
800	300 (C)	300 (C)
24	20 (C)	24 (C)
2.5	AWG 30...12	AWG 30...12
8 kV / 3		
A2 / V-0		

Rated connection	
0.5...4 / 0.5...2.5	
0.5...2.5 / 0.5...2.5	
10 / 0.6 x 3.5 mm	
2.5 mm ² flexible wires with wire-end ferrules are crimped with the Weidmüller PZ 6/5 crimping tool.	

Type	Qty.	Order No.
ZDK 2.5/3AN V	50	1924490000
ZDK 2.5/3AN V BL	50	1924480000

Type	current	Qty.	Order No.
ZQV 2.5/2	24 A	60	1608860000
ZQV 2.5/3	24 A	60	1608870000
ZQV 2.5/4	24 A	60	1608880000
ZQV 2.5/10	24 A	20	1608940000
ZQV 2.5/20	24 A	20	1908960000
Width			
ZAP/TW ZDK 2.5/3AN	1.5 mm	20	1924910000
ZEW 35	6 mm	20	9540000000
ZTA ZT2.5	5.1 mm	25	1827080000
ZTA ZT2.5/ZA	5.1 mm	25	1847600000
SDIS SL 0.6X3.5X100		1	1274660000
ZRH 1.5H/1	4.85 mm	1000	1678810000
ZRH 1.5H/2	4.85 mm	1000	1678800000
ZAD 9/4	6 mm	20	1934160000

SNAPMARK I / DEK 5/5 / WS 10/5	
2.5 mm ² wires with wire ferrules including the plastic collar only clampable with diameter-optimised collar (Order no. 1333100000, pack of 500).	

Compact style

ZDK 2.5/3AN DU-PE

2.5 mm²

Double-level terminal (DU-PE)

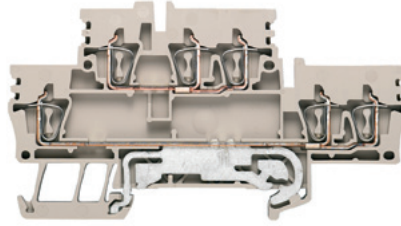

In hazardous area applications, the installation instructions and the rated data specifications for accessories given in the technical appendix must be followed.

Width/Length/Height of lowest version	mm
max. current / max. cond. cross-section	A/mm ²
Max. clamping range	mm ²

5.1 x 93 x 51.5	
31 / 4	
0.05...4	

Technical data

Rated data	
Rated cross-section	mm ²
Rated voltage to adjoining terminal	V
Rated impulse withstand voltage to adjacent terminal	kV
Pollution severity	
Gauge to IEC 60947-1 / Flammability class UL94	
Approvals	
Clamped conductors (H05V/H07V)	
Solid / stranded	mm ²
Flexible / Flexible with ferrule	mm ²
Stripping length / Blade size	mm/-
Note	

IEC 60947-7-1 (-7-2)		II 2 G D	
IEC	UL	CSA	
2.5	AWG 30...12	AWG 30...12	
800			
8			
3			
A2 / V-0			
Rated connection			
0.5...4 / 0.5...2.5			
0.5...2.5 / 0.5...2.5			
10 / 0.6 x 3.5 mm			
2.5 mm ² flexible wires with wire-end ferrules are crimped with the Weidmüller PZ 6/5 crimping tool.			

Ordering data

Version	green/yellow Wemid
Note	

Type	Qty.	Order No.
ZDK 2.5/3AN DU-PE	50	1924460000

Accessories

Pluggable cross-connection	
	2-pole
	3-pole
	4-pole
	10-pole
	20-/24-pole
End plate / Partition plate	
	Dark beige Wemid
End bracket	
	Dark beige Wemid
Test adapter	
	Standard
	With assembly peg
Screwdriver	
	Standard
Reducing sleeves	
	For conductors < 0.5 mm ² / AWG 20
	For conductors < 1.0 mm ² / AWG 18
Cover	
	With lightning flash symbol

Type	current	Qty.	Order No.
ZQV 2.5/2	24 A	60	1608860000
ZQV 2.5/3	24 A	60	1608870000
ZQV 2.5/4	24 A	60	1608880000
ZQV 2.5/10	24 A	20	1608940000
ZQV 2.5/20	24 A	20	1908960000
Width			
ZAP/TW ZDK 2.5/3AN	1.5 mm	20	1924910000
ZEW 35	6 mm	20	9540000000
ZTA ZT2.5	5.1 mm	25	1827080000
ZTA ZT2.5/ZA	5.1 mm	25	1847600000
SDIS SL 0.6X3.5X100		1	1274660000
ZRH 1.5H/1	4.85 mm	1000	1678810000
ZRH 1.5H/2	4.85 mm	1000	1678800000
ZAD 9/4	6 mm	20	1934160000

Identification systems	(see assortment in catalogue 7)
	Marking tags
Note	

Snapmark 1 / DEK 5/5 / WS 10/5
2.5 mm ² wires with wire ferrules including the plastic collar only clampable with diameter-optimised collar (Order no. 1333100000, pack of 500).

Motor-connect terminal blocks

Standard form

Z-series standard ranges provide solutions for conductor cross-sections from 0.05 to 35 mm².

In hazardous area applications, the installation instructions and the rated data specifications for accessories given in the technical appendix must be followed.

Width/Length/Height of lowest version	mm
max. current / max. cond. cross-section	A/mm ²
Max. clamping range	mm ²

Technical data

Rated data	
Rated voltage	V
Rated current	A
Rated cross-section	mm ²
Rated impulse withstand voltage / Pollution severity	
Gauge to IEC 60947-1 / Flammability class UL94	
Approvals	
Clamped conductors (H05V/H07V)	
Solid / stranded	mm ²
Flexible / Flexible with ferrule	mm ²
Stripping length / Blade size	mm/-
Note	

Ordering data

Version	Dark beige Wemid
Note	

Accessories

End plate / Partition plate	Dark beige Wemid
End bracket	Dark beige Wemid
Screwdriver	Standard
Reducing sleeves	For conductors < 0.5 mm ² / AWG 20 For conductors < 1.0 mm ² / AWG 18
Test adapter	Standard

Identification systems	(see assortment in catalogue 7) Marking tags
Note	

ZMAK 2.5

2.5 mm²

Motor-supply terminal

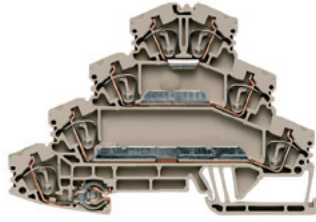

5.1 x 102 x 70	
31 / 4	
0.13...4	

IEC 60947-7-1 (-7-2)

IEC	UL	CSA
400	300 (D)	300 (D)
24	10 (D)	25 (D)
2.5	AWG 26...12	AWG 26...12
6 kV / 3		
A3 / V-0		
Rated connection		
0.5...4		
0.5...4 / 0.5...2.5		
10 / 0.6 x 3.5 mm		

Type	Qty.	Order No.
ZMAK 2.5	25	1768000000
The ZMAK 2.5 690 V: with pre-assembled end plate and a width of 6.1 mm!		

Type	Width	Qty.	Order No.
ZAP ZMAK2.5	1.5 mm	10	1768010000
ZEW 35	6 mm	20	9540000000
SDIS SL 0.6X3.5X100		1	1274660000
ZRH 1.5H/1	4.85 mm	1000	1678810000
ZRH 1.5H/2	4.85 mm	1000	1678800000
ZTA 1	5.1 mm	25	1609040000

Identification systems	(see assortment in catalogue 7) Marking tags
Note	

ZMAK 2.5 690 V

2.5 mm²

Motor-supply terminal

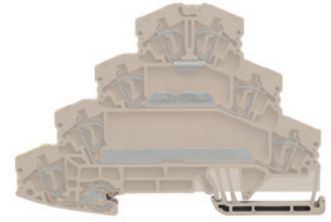

6.1 x 102 x 70	
31 / 4	
0.13...4	

IEC 60947-7-1 (-7-2)

IEC	UL	CSA
690	300 (D)	
24	10 (D)	
2.5	AWG 26...12	
6 kV / 3		
A3 / V-0		
Rated connection		
0.5...4		
0.5...4 / 0.5...2.5		
10 / 0.6 x 3.5 mm		

Type	Qty.	Order No.
ZMAK 2.5 690V	25	1027550000
The ZMAK 2.5 690 V: with pre-assembled end plate and a width of 6.1 mm!		

Type	Width	Qty.	Order No.
ZAP ZMAK2.5	1.5 mm	10	1768010000
ZEW 35	6 mm	20	9540000000
SDIS SL 0.6X3.5X100		1	1274660000
ZRH 1.5H/1	4.85 mm	1000	1678810000
ZRH 1.5H/2	4.85 mm	1000	1678800000

Identification systems	(see assortment in catalogue 7) Marking tags
Note	

PE terminals

Standard model

Z-series standard ranges provide solutions for conductor cross-sections from 0.05 to 35 mm².

In hazardous area applications, the installation instructions and the rated data specifications for accessories given in the technical appendix must be followed.

Width/Length/Height of lowest version	mm
max. current / max. cond. cross-section	A/mm ²
Max. clamping range	mm ²

Technical data

Rated data	
Rated cross-section	mm ²
Rated voltage to adjoining terminal	V
Rated impulse withstand voltage to adjacent terminal	kV
Pollution severity	
Gauge to IEC 60947-1 / Flammability class UL94	
Approvals	
Clamped conductors (H05V/H07V)	
Solid / stranded	mm ²
Flexible / Flexible with ferrule	mm ²
Stripping length / Blade size	mm/-
Note	

Ordering data

Version	
	green/yellow Wemid
Note	

Accessories

End plate / Partition plate	
	Dark beige Wemid
End bracket	
	Dark beige Wemid
Test adapter	
	Standard
	With assembly peg
Screwdriver	
	Standard
Reducing sleeves	
	For conductors < 0.5 mm ² / AWG 20
	For conductors < 1.0 mm ² / AWG 18

Identification systems	(see assortment in catalogue 7)
	Marking tags
Note	

ZPE 1.5

1.5 mm²

Two connections

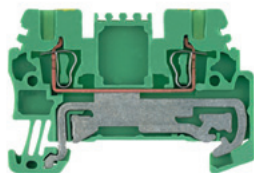

3.5 x 54.5 x 37	
/ 1.5	
0.05...1.5	

IEC 60947-7-2	Ex e II	Ex	II 2 G D
IEC	UL	CSA	EN 60079-7
1.5	AWG 26...14	AWG 26...14	1.5
500			
6			
	3		
	B1 / V-0		
KEMA 01ATEX2106 U			
Rated connection			
0.5...1.5			
0.5...1.5 / 0.5...1.5			
10 / 0.4 x 2.0 mm			

Type	Qty.	Order No.
ZPE 1.5	100	1775510000

Type	Width	Qty.	Order No.
ZAP/TW ZDU1.5/2AN	2 mm	20	1776030000
ZEW 35	6 mm	20	9540000000
ZTA 5	3.5 mm	25	1776210000
ZTA 5/ZA	3.5 mm	25	1776220000
SDS 0.4X2.0X60		1	9037160000
ZRH 1.5S/1	4.55 mm	500	1781950000
ZRH 1.5S/2	4.55 mm	500	1781960000

Identification systems	(see assortment in catalogue 7)
	Marking tags
Note	

DEK 5/3,5 / WS 12/3,5

ZPE 1.5/3AN

1.5 mm²

Three connections

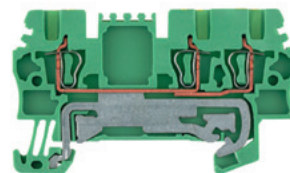

3.5 x 63 x 37	
/ 1.5	
0.05...1.5	

IEC 60947-7-2	Ex e II	Ex	II 2 G D
IEC	UL	CSA	EN 60079-7
1.5	AWG 26...14	AWG 26...14	1.5
500			
6			
	3		
	B1 / V-0		
KEMA 01ATEX2106 U			
Rated connection			
0.5...1.5			
0.5...1.5 / 0.5...1.5			
10 / 0.4 x 2.0 mm			

Type	Qty.	Order No.
ZPE 1.5/3AN	100	1775560000

Type	Width	Qty.	Order No.
ZAP/TW ZDU1.5/3AN	2 mm	20	1776060000
ZEW 35	6 mm	20	9540000000
ZTA 5	3.5 mm	25	1776210000
ZTA 5/ZA	3.5 mm	25	1776220000
SDS 0.4X2.0X60		1	9037160000
ZRH 1.5S/1	4.55 mm	500	1781950000
ZRH 1.5S/2	4.55 mm	500	1781960000

Identification systems	(see assortment in catalogue 7)
	Marking tags
Note	

DEK 5/3,5 / WS 12/3,5

ZPE 1.5/4AN

1.5 mm²

Four connections

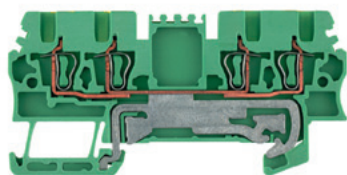

3.5 x 75.5 x 37
/ 1.5
0.05...1.5



IEC 60947-7-2

Ex e II II 2 G D

IEC	UL	CSA	EN 60079-7
1.5	AWG 26...14	AWG 26...12	1.5
500			
6			

3
B1 / V-0

KEMA 01ATEX2106 U

Rated connection
0.5...1.5
0.5...1.5 / 0.5...1.5
10 / 0.4 x 2.0 mm

Type	Qty.	Order No.
ZPE 1.5/4AN	100	1775620000

Type	Width	Qty.	Order No.
ZAP/TW ZDU1.5/4AN	2 mm	20	1776090000
ZEW 35	6 mm	20	9540000000
ZTA 5	3.5 mm	25	1776210000
ZTA 5/ZA	3.5 mm	25	1776220000
SDS 0.4X2.0X60		1	9037160000
ZRH 1.5S/1	4.55 mm	500	1781950000
ZRH 1.5S/2	4.55 mm	500	1781960000

DEK 5/3,5 / WS 12/3,5

ZPE 2.5

2.5 mm²

Two connections

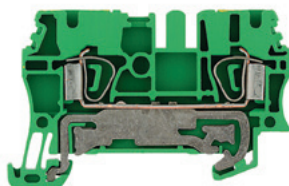

5.1 x 63 x 39.5
/ 4
0.05...4

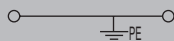

IEC 60947-7-2

Ex e II II 2 G D

IEC	UL	CSA	EN 60079-7
2.5	AWG 30...12	AWG 26...12	2.5
800			
8			

3
A3 / V-0

KEMA 97ATEX2521 U

Rated connection
0.5...4
0.5...4 / 0.5...2.5
10 / 0.6 x 3.5 mm

Type	Qty.	Order No.
ZPE 2.5	100	1608640000

Type	Width	Qty.	Order No.
ZAP/TW 1	2 mm	50	1608740000
ZEW 35	6 mm	20	9540000000
ZTA 1	5.1 mm	25	1609040000
ZTA 1/ZA	5.1 mm	25	1609050000
SDIS SL 0.6X3.5X100		1	1274660000
ZRH 2.5/1 WS	5.55 mm	1000	1614300000
ZRH 2.5/2 GR/V0	5.55 mm	1000	1614290000

DEK 5/5 / WS 10/5

ZPE 2.5/3AN

2.5 mm²

Three connections

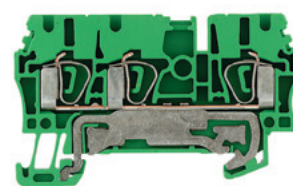

5.1 x 64.5 x 39.5
/ 4
0.05...4

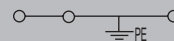

IEC 60947-7-2

Ex e II II 2 G D

IEC	UL	CSA	EN 60079-7
2.5	AWG 30...12	AWG 26...12	2.5
800			
8			

3
A3 / V-0

KEMA 97ATEX2521 U

Rated connection
0.5...4
0.5...4 / 0.5...2.5
10 / 0.6 x 3.5 mm

Type	Qty.	Order No.
ZPE 2.5/3AN	100	1608650000

Type	Width	Qty.	Order No.
ZAP/TW 2 DB	2 mm	50	1608770000
ZEW 35	6 mm	20	9540000000
ZTA 1	5.1 mm	25	1609040000
ZTA 1/ZA	5.1 mm	25	1609050000
SDIS SL 0.6X3.5X100		1	1274660000
ZRH 2.5/1 WS	5.55 mm	1000	1614300000
ZRH 2.5/2 GR/V0	5.55 mm	1000	1614290000

DEK 5/5 / WS 10/5

PE terminals

Standard model

Z-series standard ranges provide solutions for conductor cross-sections from 0.05 to 35 mm².

In hazardous area applications, the installation instructions and the rated data specifications for accessories given in the technical appendix must be followed.

Width/Length/Height of lowest version	mm
max. current / max. cond. cross-section	A/mm ²
Max. clamping range	mm ²

Technical data

Rated data	
Rated cross-section	mm ²
Rated voltage to adjoining terminal	V
Rated impulse withstand voltage to adjacent terminal	kV
Pollution severity	
Gauge to IEC 60947-1 / Flammability class UL94	
Approvals	
Clamped conductors (H05V/H07V)	
Solid / stranded	mm ²
Flexible / Flexible with ferrule	mm ²
Stripping length / Blade size	mm/-
Note	

Ordering data

Version	green/yellow Wemid
Note	

Accessories

End plate / Partition plate	Dark beige Wemid
End bracket	Dark beige Wemid
Test adapter	Standard With assembly peg
Screwdriver	Standard
Reducing sleeves	For conductors < 0.5 mm ² / AWG 20 For conductors < 1.0 mm ² / AWG 18

Identification systems	(see assortment in catalogue 7) Marking tags
Note	

ZPE 2.5/4AN

2.5 mm²

Four connections

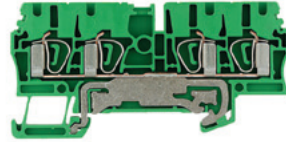

5.1 x 79.5 x 39.5	
/ 4	
0.05...4	

IEC 60947-7-2	Ex e II		II 2 G D
IEC	UL	CSA	EN 60079-7
2.5	AWG 30...12	AWG 26...12	2.5
800			
8			
	3		
	A3 / V-0		
			KEMA 97ATEX2521 U
Rated connection			
0.5...4			
0.5...4 / 0.5...2.5			
10 / 0.6 x 3.5 mm			

Type	Qty.	Order No.
ZPE 2.5/4AN	100	1608660000

Type	Width	Qty.	Order No.
ZAP/TW 3	2 mm	50	1608800000
ZEW 35	6 mm	20	9540000000
ZTA 1	5.1 mm	25	1609040000
ZTA 1/ZA	5.1 mm	25	1609050000
SDIS SL 0.6X3.5X100		1	1274660000
ZRH 2.5/1 WS	5.55 mm	1000	1614300000
ZRH 2.5/2 GR/V0	5.55 mm	1000	1614290000

Identification systems	(see assortment in catalogue 7) Marking tags
Note	

ZPE 4

4 mm²

Two connections

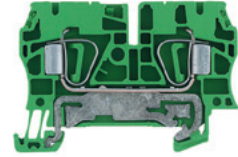

6.1 x 64 x 43.5	
/ 6	
0.13...6	

IEC 60947-7-2	Ex e II		II 2 G D
IEC	UL	CSA	EN 60079-7
4	AWG 26...10	AWG 26...10	4
800			
8			
	3		
	A4 / V-0		
			KEMA 97ATEX2521 U
Rated connection			
0.5...6 / 1.5...6			
0.5...6 / 0.5...4			
12 / 0.6 x 3.5 mm			

Type	Qty.	Order No.
ZPE 4	100	1632080000

Type	Width	Qty.	Order No.
ZAP/TW 4	2 mm	50	1632090000
ZEW 35	6 mm	20	9540000000
ZTA 2 ZDU4	6.1 mm	25	1609060000
ZTA 2/ZA ZDU4	6.1 mm	25	1609070000
SDIS SL 0.6X3.5X100		1	1274660000
ZRH 4/1 WS	7.4 mm	1000	1636640000
ZRH 4/2	7.4 mm	1000	1636650000

Identification systems	(see assortment in catalogue 7) Marking tags
Note	

ZPE 4/3 AN

4 mm²

Three connections

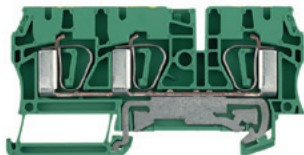

6.1 x 85.5 x 43.5
/ 6
0.13...6



IEC 60947-7-2 Ex e II II 2 G D

IEC	UL	CSA	EN 60079-7
4	AWG 26...10	AWG 26...10	4
800			
8			
3			
A4 / V-0			

KEMA 00ATEX2107 U

Rated connection
0.5...6 / 0.5...6
0.5...6 / 0.5...4
12 / 0.6 x 3.5 mm

Type	Qty.	Order No.
ZPE 4/3AN	50	7904170000

Type	Width	Qty.	Order No.
ZAP/TW 4/3AN	2 mm	20	7904100000
ZEW 35	6 mm	20	9540000000
ZTA 2 ZDU4	6.1 mm	25	1609060000
ZTA 2/ZA ZDU4	6.1 mm	25	1609070000
SDIS SL 0.6X3.5X100		1	1274660000
ZRH 4/1 WS	7.4 mm	1000	1636640000
ZRH 4/2	7.4 mm	1000	1636650000

DEK 5/6 / WS 12/6

ZPE 4/4 AN

4 mm²

Four connections

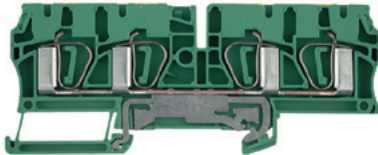

6.1 x 104.5 x 43.5
/ 6
0.13...6



IEC 60947-7-2 Ex e II II 2 G D

IEC	UL	CSA	EN 60079-7
4	AWG 26...10	AWG 26...10	4
800			
8			
3			
A4 / V-0			

KEMA 00ATEX2107 U

Rated connection
0.5...6 / 0.5...6
0.5...6 / 0.5...4
12 / 0.6 x 3.5 mm

Type	Qty.	Order No.
ZPE 4/4AN	50	7904280000

Type	Width	Qty.	Order No.
ZAP/TW4/4AN	2 mm	20	7904210000
ZEW 35	6 mm	20	9540000000
ZTA 2 ZDU4	6.1 mm	25	1609060000
ZTA 2/ZA ZDU4	6.1 mm	25	1609070000
SDIS SL 0.6X3.5X100		1	1274660000
ZRH 4/1 WS	7.4 mm	1000	1636640000
ZRH 4/2	7.4 mm	1000	1636650000

DEK 5/6 / WS 12/6

PE terminals

Standard model

Z-series standard ranges provide solutions for conductor cross-sections from 0.05 to 35 mm².

In hazardous area applications, the installation instructions and the rated data specifications for accessories given in the technical appendix must be followed.

Width/Length/Height of lowest version	mm
max. current / max. cond. cross-section	A/mm ²
Max. clamping range	mm ²

Technical data

Rated data	
Rated cross-section	mm ²
Rated voltage to adjoining terminal	V
Rated impulse withstand voltage to adjacent terminal	kV
Pollution severity	
Gauge to IEC 60947-1 / Flammability class UL94	
Approvals	
Clamped conductors (H05V/H07V)	
Solid / stranded	mm ²
Flexible / Flexible with ferrule	mm ²
Stripping length / Blade size	mm/-
Note	

Ordering data

Version	green/yellow Wemid
Note	

Accessories

End plate / Partition plate	Dark beige Wemid
End bracket	Dark beige Wemid
Test adapter	Standard With assembly peg
Screwdriver	Standard
Reducing sleeves	For conductors < 0.5 mm ² / AWG 20 For conductors < 1.0 mm ² / AWG 18

Identification systems	(see assortment in catalogue 7) Marking tags
Note	

ZPE 6

6 mm²

Two connections

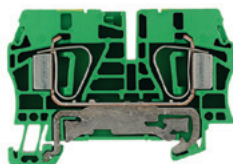

8.1 x 65 x 45.5	
/ 10	
0.22...10	

IEC 60947-7-2		Ex e II		Ex		II 2 G D	
IEC	UL	CSA	EN 60079-7				
6	AWG 22...8	AWG 20...8	6				
800							
8							
3							
A5 / V-0							
		KEMA 97ATEX2521 U					
Rated connection							
0.5...10 / 1.5...10							
0.5...10 / 0.5...6							
13 / 0.6 x 3.5 mm							
Note							

Type	Qty.	Order No.
ZPE 6	50	1608670000
Note		

Type	Width	Qty.	Order No.
ZAP/TW 5	2 mm	50	1608830000
ZEW 35	6 mm	20	9540000000
ZTA 3 ZDU6	8.1 mm	25	1654050000
SDIS SL 1.0X4.5X125		1	1274680000
Note			

Identification systems	(see assortment in catalogue 7) Marking tags
Note	DEK 5/8 / WS 12/6

ZPE 6/3 AN

6 mm²

Three connections

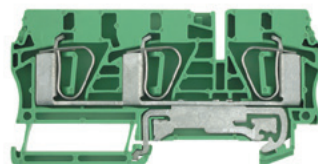

8.1 x 90 x 45.5	
/ 10	
0.22...10	

IEC 60947-7-2		Ex e II		Ex		II 2 G D	
IEC	UL	CSA	EN 60079-7				
6	AWG 22...8	AWG 20...8	6				
800							
8							
3							
A5 / V-0							
		KEMA 00ATEX2107 U					
Rated connection							
0.5...10 / 1.5...10							
0.5...10 / 0.5...6							
13 / 0.6 x 3.5 mm							
Note							

Type	Qty.	Order No.
ZPE 6/3AN	50	7907400000
Note		

Type	Width	Qty.	Order No.
ZAP/TW6/3AN	2 mm	20	7907370000
ZEW 35	6 mm	20	9540000000
ZTA 3 ZDU6	8.1 mm	25	1654050000
SDIS SL 1.0X4.5X125		1	1274680000
Note			

Identification systems	(see assortment in catalogue 7) Marking tags
Note	DEK 5/8 / WS 12/6

ZPE 10

10 mm²

Two connections

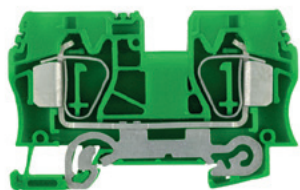

10.1 x 73.5 x 50.5
/ 16
1.31...16

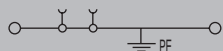

IEC 60947-7-2 Ex e II II 2 G D

IEC	UL	CSA	EN 60079-7
10	AWG 16...6	AWG 16...6	10
800			
8			
3			
A6 / V-0			

KEMA 99ATEX5514 U

Rated connection

1.5...16 / 10...16
1.5...10 / 1.5...10
18 / 1.0 x 5.5 mm

Type	Qty.	Order No.
ZPE 10	25	1746770000

Type	Width	Qty.	Order No.
ZAP/TW ZDU10	2.7 mm	20	1748660000
ZEW 35	6 mm	20	9540000000
SDIS SL 1.0X4.5X125		1	1274680000

DEK 5/5 / WS 12/6

ZPE 10/3 AN

10 mm²

Three connections

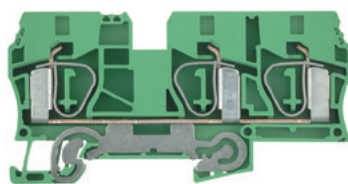

10.1 x 99 x 50.5
/ 16
1.31...16

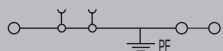

IEC 60947-7-2 Ex e II II 2 G D

IEC	UL	CSA	EN 60079-7
10	AWG 16...6	AWG 16...6	10
800			
8			
3			
A6 / V-0			

KEMA 00ATEX2107 U

Rated connection

1.5...16 / 10...16
1.5...10 / 1.5...10
18 / 1.0 x 5.5 mm

Type	Qty.	Order No.
ZPE 10/3AN	20	1767670000

Type	Width	Qty.	Order No.
ZAP/TW 10/16	3 mm	20	1749580000
ZEW 35	6 mm	20	9540000000
SDIS SL 1.0X4.5X125		1	1274680000

DEK 5/5 / WS 12/6

PE terminals

Standard model

Z-series standard ranges provide solutions for conductor cross-sections from 0.05 to 35 mm².

In hazardous area applications, the installation instructions and the rated data specifications for accessories given in the technical appendix must be followed.

Width/Length/Height of lowest version	mm
max. current / max. cond. cross-section	A/mm ²
Max. clamping range	mm ²

Technical data

Rated data	
Rated cross-section	mm ²
Rated voltage to adjoining terminal	V
Rated impulse withstand voltage to adjacent terminal	kV
Pollution severity	
Gauge to IEC 60947-1 / Flammability class UL94	
Approvals	
Clamped conductors (H05V/H07V)	
Solid / stranded	mm ²
Flexible / Flexible with ferrule	mm ²
Stripping length / Blade size	mm/-
Note	

Ordering data

Version	
	green/yellow Wemid
Note	

Accessories

End plate / Partition plate	
	Dark beige Wemid
End bracket	
	Dark beige Wemid
Test adapter	
	Standard With assembly peg
Screwdriver	
	Standard
Reducing sleeves	
	For conductors < 0.5 mm ² / AWG 20 For conductors < 1.0 mm ² / AWG 18

Identification systems	(see assortment in catalogue 7)
	Marking tags
Note	

ZPE 16

16 mm²

Two connections

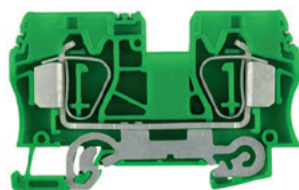

12.1 x 82.5 x 51.5	
/ 25	
1.5...25	

IEC 60947-7-2	Ex e II		II 2 G D
IEC	UL	CSA	EN 60079-7
16	AWG 14...4	AWG 14...4	16
800			
8			
3			
A7 / V-0			
KEMA 99ATEX5514 U			
Rated connection			
1.5...16 / 16...25			
1.5...16 / 1.5...16			
18 / 1.0 x 5.5 mm			
To ensure the current-carrying capacity of the mounting rail, it is necessary to use the TS 35 x 15.			

Type	Qty.	Order No.
ZPE 16	25	1745250000

Type	Width	Qty.	Order No.
ZAP/TW ZDU16	3 mm	20	1745150000
ZEW 35	6 mm	20	9540000000
SDIS SL 1.0X4.5X125		1	1274680000

DEK 5/5 / WS 15/5
The plug-in cross-connections ZQV 16/2 (1739690000) can be used.

ZPE 16/3AN

16 mm²

Three connections

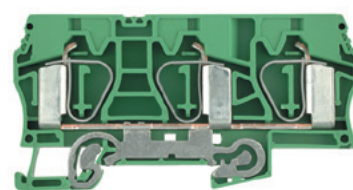

12.1 x 99 x 51.5	
/ 25	
1.5...25	

IEC 60947-7-2	Ex e II		II 2 G D
IEC	UL	CSA	EN 60079-7
16	AWG 14...4	AWG 14...4	16
800			
8			
3			
A7 / V-0			
KEMA 00ATEX2107 U			
Rated connection			
1.5...16 / 16...25			
1.5...16 / 1.5...16			
18 / 1.0 x 5.5 mm			
To ensure the current-carrying capacity of the mounting rail, it is necessary to use the TS 35 x 15.			

Type	Qty.	Order No.
ZPE 16/3AN	20	1768310000

Type	Width	Qty.	Order No.
ZAP/TW 10/16	3 mm	20	1749580000
ZEW 35	6 mm	20	9540000000
SDIS SL 1.0X4.5X125		1	1274680000

DEK 5/5 / WS 15/5

ZPE 35

35 mm²

Two connections

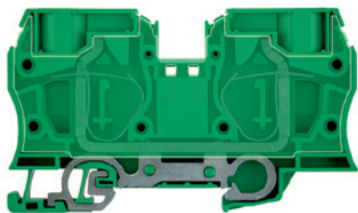

16 x 100.5 x 59.5
/ 35
2.5...35

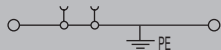

IEC 60947-7-2

Ex e II II 2 G D

IEC	UL	CSA	EN 60079-7
35	AWG 12...2	AWG 12...2	35
800			
8			
	3		
	A8 / V-0		

KEMA 00ATEX2107 U

Rated connection

2.5...16 / 2.5...35

2.5...35 / 2.5...35

25 / 1.0 x 5.5 mm

To ensure the current-carrying capacity of the mounting rail, it is necessary to use the TS 35 x 15.

Type	Qty.	Order No.
ZPE 35	10	1739650000
Integrated end plate.		

Type	Width	Qty.	Order No.
ZEW 35	6 mm	20	9540000000
SDIS SL 1.0X4.5X125		1	1274680000

DEK 5/5 / WS 15/5

The plug-in cross-connections ZDV 35/2 (1739700000) can be used.

PE terminals

Roof-style

The compact terminal range for conductor cross-sections 0.13 to 16 mm²

In hazardous area applications, the installation instructions and the rated data specifications for accessories given in the technical appendix must be followed.

Width/Length/Height of lowest version	mm
max. current / max. cond. cross-section	A/mm ²
Max. clamping range	mm ²

Technical data

Rated data	
Rated cross-section	mm ²
Rated voltage to adjoining terminal	V
Rated impulse withstand voltage to adjacent terminal	kV
Rated short-time current	
Pollution severity	
Gauge to IEC 60947-1 / Flammability class UL94	
Approvals	
Clamped conductors (H05V/H07V)	
Solid / stranded	mm ²
Flexible / Flexible with ferrule	mm ²
Stripping length / Blade size	mm/-
Note	

Ordering data

Version	green/yellow Wemid
Note	

Accessories

End plate / Partition plate	Dark beige Wemid
End bracket	Dark beige Wemid
Test adapter	With assembly peg
Screwdriver	Standard
Reducing sleeves	For conductors < 0.5 mm ² / AWG 20 For conductors < 1.0 mm ² / AWG 18

Identification systems	(see assortment in catalogue 7) Marking tags
Note	

ZPE 2.5-2

2.5 mm²

Two connections



5.1 x 50.5 x 44	
/ 4	
0.13...4	

IEC 60947-7-2	Ex e II		II 2 G D
IEC	UL	CSA	EN 60079-7
2.5	AWG 26...12	AWG 26...12	2.5
800			
8			
	300 A (2.5 mm ²)		
	3		
	A2 / V-0		
			KEMA 97ATEX4677 U
Rated connection			
0.5...4			
0.5...2.5 / 0.5...2.5			
10 / 0.6 x 3.5 mm			
2.5 mm ² flexible wires with wire-end ferrules are crimped with the Weidmüller PZ 6/5 crimping tool.			

Type	Qty.	Order No.
ZPE 2.5-2	100	1772090000

Type	Width	Qty.	Order No.
ZAP/TW7	2.5 mm	50	1706110000
ZEW 35	6 mm	20	9540000000
ZTA 4	5.1 mm	25	1688110000
SDIS SL 0.6X3.5X100		1	1274660000
ZRH 1.5H/1	4.85 mm	1000	1678810000
ZRH 1.5H/2	4.85 mm	1000	1678800000

Identification systems	(see assortment in catalogue 7) Marking tags
Note	

ZPE 2.5-2/3AN

2.5 mm²

Three connections



5.1 x 50.5 x 44	
/ 4	
0.13...4	

IEC 60947-7-2	Ex e II		II 2 G D
IEC	UL	CSA	EN 60079-7
2.5	AWG 26...12	AWG 26...14	2.5
800			
8			
	300 A (2.5 mm ²)		
	3		
	A2 / V-0		
			KEMA 97ATEX4677 U
Rated connection			
0.5...4			
0.5...2.5 / 0.5...2.5			
10 / 0.6 x 3.5 mm			
2.5 mm ² flexible wires with wire-end ferrules are crimped with the Weidmüller PZ 6/5 crimping tool.			

Type	Qty.	Order No.
ZPE 2.5-2/3AN	100	1706090000

Type	Width	Qty.	Order No.
ZAP/TW7	2.5 mm	50	1706110000
ZEW 35	6 mm	20	9540000000
ZTA 4	5.1 mm	25	1688110000
SDIS SL 0.6X3.5X100		1	1274660000
ZRH 1.5H/1	4.85 mm	1000	1678810000
ZRH 1.5H/2	4.85 mm	1000	1678800000

Identification systems	(see assortment in catalogue 7) Marking tags
Note	

ZPE 2.5-2/4AN

2.5 mm²

Four connections



5.1 x 50.5 x 44
/ 4
0.13...4



IEC 60947-7-2

Ex e II II 2 G D

IEC	UL	CSA	EN 60079-7
2.5	AWG 26...12	AWG 26...14	2.5
800			
8			
300 A (2.5 mm ²)			
3			
A2 / V-0			

KEMA 97ATEX4677 U

Rated connection
0.5...4
0.5...2.5 / 0.5...2.5
10 / 0.6 x 3.5 mm

2.5 mm² flexible wires with wire-end ferrules are crimped with the Weidmüller PZ 6/5 crimping tool.

Type	Qty.	Order No.
ZPE 2.5-2/4AN	100	1706100000

Type	Width	Qty.	Order No.
ZAP/TW7	2.5 mm	50	1706110000
ZEW 35	6 mm	20	9540000000
ZTA 4	5.1 mm	25	1688110000
SDIS SL 0.6X3.5X100		1	1274660000
ZRH 1.5H/1	4.85 mm	1000	1678810000
ZRH 1.5H/2	4.85 mm	1000	1678800000

DEK 5/5 / WS 10/5

ZPE 4-2/2AN

4 mm²

Two connections



6.1 x 61.5 x 46
/ 6
0.13...6



IEC 60947-7-2

Ex e II II 2 G D

IEC	UL	CSA	EN 60079-7
4	AWG 26...10	AWG 26...10	4
800			
8			
480 A (4 mm ²)			
3			
A3 / V-0			

KEMA 97ATEX4677 U

Rated connection
0.5...6
0.5...4 / 0.5...4
10 / 0.6 x 3.5 mm

Type	Qty.	Order No.
ZPE 4-2/2AN	100	1770380000

Type	Width	Qty.	Order No.
ZAP ZDU4-2	2 mm	50	1770400000
ZEW 35	6 mm	20	9540000000
ZTA 6/ZA	6.1 mm	25	1780660000
SDIS SL 0.6X3.5X100		1	1274660000
ZRH 4/1 WS	7.4 mm	1000	1636640000
ZRH 4/2	7.4 mm	1000	1636650000

DEK 5/6 / WS 12/6

ZPE 4-2/3AN

4 mm²

Three connections



6.1 x 61.5 x 46
/ 6
0.13...6



IEC 60947-7-2

Ex e II II 2 G D

IEC	UL	CSA	EN 60079-7
4	AWG 26...10	AWG 26...10	4
800			
8			
480 A (4 mm ²)			
3			
A3 / V-0			

KEMA 97ATEX4677 U

Rated connection
0.5...6
0.5...4 / 0.5...4
10 / 0.6 x 3.5 mm

Type	Qty.	Order No.
ZPE 4-2/3AN	100	1770390000

Type	Width	Qty.	Order No.
ZAP ZDU4-2	2 mm	50	1770400000
ZEW 35	6 mm	20	9540000000
ZTA 6/ZA	6.1 mm	25	1780660000
SDIS SL 0.6X3.5X100		1	1274660000
ZRH 4/1 WS	7.4 mm	1000	1636640000
ZRH 4/2	7.4 mm	1000	1636650000

DEK 5/6 / WS 12/6

PE terminals

Roof-style

The compact terminal range for conductor cross-sections 0.13 to 16 mm²

In hazardous area applications, the installation instructions and the rated data specifications for accessories given in the technical appendix must be followed.

Width/Length/Height of lowest version	mm
max. current / max. cond. cross-section	A/mm ²
Max. clamping range	mm ²

Technical data

Rated data	
Rated cross-section	mm ²
Rated voltage to adjoining terminal	V
Rated impulse withstand voltage to adjacent terminal	kV
Rated short-time current	480 A (4 mm ²)
Pollution severity	3
Gauge to IEC 60947-1 / Flammability class UL94	A3 / V-0
Approvals	
Clamped conductors (H05V/H07V)	
Solid / stranded	mm ²
Flexible / Flexible with ferrule	mm ²
Stripping length / Blade size	mm/-

Note

Ordering data

Version	green/yellow Wemid
Note	

Accessories

End plate / Partition plate	Dark beige Wemid
End bracket	Dark beige Wemid
Test adapter	With assembly peg
Screwdriver	Standard
Reducing sleeves	For conductors < 0.5 mm ² / AWG 20 For conductors < 1.0 mm ² / AWG 18

Identification systems (see assortment in catalogue 7)
Marking tags

Note

ZPE 4-2/4 AN

4 mm²

Four connections



6.1 x 75 x 46	/ 6	
0.13...6		

IEC 60947-7-2 Ex e II II 2 G D

IEC	UL	CSA	EN 60079-7
4	AWG 26...10	AWG 26...10	4
800			
8			
480 A (4 mm ²)			
3			
A3 / V-0			
Rated connection			
0.5...6			
0.5...4 / 0.5...4			
10 / 0.6 x 3.5 mm			

Type	Qty.	Order No.
ZPE 4-2/4AN	100	1807090000

Type	Width	Qty.	Order No.
ZAP ZDU4-2/4AN	2 mm	50	1807010000
ZEW 35	6 mm	20	9540000000
ZTA 6/ZA	6.1 mm	25	1780660000
SDIS SL 0.6X3.5X100		1	1274660000
ZRH 4/1 WS	7.4 mm	1000	1636640000
ZRH 4/2	7.4 mm	1000	1636650000

DEK 5/6 / WS 12/6

ZPE 6-2/2AN

6 mm²

Two connections



8.1 x 68 x 50	/ 10	
0.22...10		

IEC 60947-7-2 Ex e II II 2 G D

IEC	UL	CSA	EN 60079-7
6	AWG 22...8	AWG 20...8	6
800			
8			
720 A (6 mm ²)			
3			
A5 / V-0			
Rated connection			
0.5...10			
0.5...10 / 0.5...6			
12 / 0.6 x 3.5 mm			

Type	Qty.	Order No.
ZPE 6-2/2AN	50	1771370000

Type	Width	Qty.	Order No.
ZAP ZDU6-2	2 mm	50	1771440000
ZEW 35	6 mm	20	9540000000
ZTA 7/ZA	8.1 mm	25	1780670000
SDIS SL 0.6X3.5X100		1	1274660000

DEK 5/8

ZPE 6-2/3AN

6 mm²

Three connections



8.1 x 68 x 50
/ 10
0.22...10



IEC 60947-7-2

Ex e II II 2 G D

IEC	UL	CSA	EN 60079-7
6	AWG 22...8	AWG 20...8	6
800			
8			
	720 A (6 mm ²)		
	3		
	A5 / V-0		

KEMA 97ATEX4677 U

Rated connection

0.5...10
0.5...10 / 0.5...6
12 / 0.6 x 3.5 mm

Type	Qty.	Order No.
ZPE 6-2/3AN	50	1771360000

Type	Width	Qty.	Order No.
ZAP ZDU6-2	2 mm	50	1771440000
ZEW 35	6 mm	20	9540000000
ZTA 7/ZA	8.1 mm	25	1780670000
SDIS SL 0.8X4.0X100		1	1274670000

DEK 5/8

ZPE 16-2/1AN

16 mm²

Supply terminal - PE

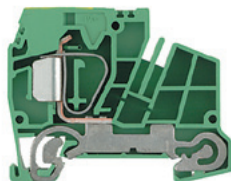

12 x 65 x 51.5
/ 25
1.5...25



IEC 60947-7-2

IEC	UL	CSA
16	AWG 14...4	AWG 26...14
800		
8		
	1920 A (16 mm ²)	
	3	
	A7 / V-0	

Rated connection

1.5...10 / 16...25
1.5...16 / 1.5...16
18 / 1.0 x 5.5 mm

Rated voltage is reduced to 400 V or the IP rated voltage of the distribution terminals.

Type	Qty.	Order No.
ZPE 16-2/1AN	20	1772960000

Type	Width	Qty.	Order No.
ZAP/Z...16-2/1AN	2.5 mm	10	1772970000
ZEW 35	6 mm	20	9540000000
SDIS SL 1.0X4.5X125		1	1274680000

DEK 5/8

The plug-in cross-connections ZQV 2.5/..., ZQV 4/... and ZQV 6/... can be used.

PE terminals

Compact style

In hazardous area applications, the installation instructions and the rated data specifications for accessories given in the technical appendix must be followed.

Width/Length/Height of lowest version	mm
max. current / max. cond. cross-section	A/mm ²
Max. clamping range	mm ²

Technical data

Rated data	
Rated cross-section	mm ²
Rated voltage to adjoining terminal	V
Rated impulse withstand voltage to adjacent terminal	kV
Pollution severity	
Gauge to IEC 60947-1 / Flammability class UL94	
Approvals	
Clamped conductors (H05V/H07V)	
Solid / stranded	mm ²
Flexible / Flexible with ferrule	mm ²
Stripping length / Blade size	mm/-
Note	

Ordering data

Version	green/yellow Wemid
Note	

Accessories

End plate / Partition plate	Dark beige Wemid
End bracket	Dark beige Wemid
Test adapter	Standard With assembly peg
Screwdriver	Standard
Reducing sleeves	For conductors < 0.5 mm ² / AWG 20 For conductors < 1.0 mm ² / AWG 18

Identification systems	(see assortment in catalogue 7) Marking tags
Note	

ZPE 2.5N

2.5 mm²

2 connections

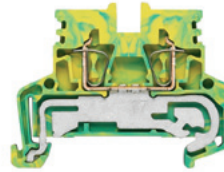

5.1 x 50.5 x 39	
/ 4	
0.05...4	

IEC 60947-7-2			II 2 G D
IEC	UL	CSA	
2.5	AWG 30...12	AWG 30...12	
800			
6			
	3		
	A2 / V-0		
Rated connection			
0.5...4 / 1.5...2.5			
0.5...2.5 / 0.5...1.5			
10 / 0.6 x 3.5 mm			
Note			
2.5 mm ² flexible wires with wire-end ferrules are crimped with the Weidmüller PZ 6/5 crimping tool.			

Type	Qty.	Order No.
ZPE 2.5N	50	1933760000

Type	Width	Qty.	Order No.
ZAP/TW ZDU/ZPE 2.5N	2 mm	20	1933790000
ZEW 35	6 mm	20	9540000000
ZTA ZT2.5	5.1 mm	25	1827080000
ZTA ZT2.5/ZA	5.1 mm	25	1847600000
SDIS SL 0.6X3.5X100		1	1274660000
ZRH 1.5H/1	4.85 mm	1000	1678810000
ZRH 1.5H/2	4.85 mm	1000	1678800000

DEK 5/5 / WS 10/5
2.5 mm ² wires with wire ferrules including the plastic collar only clampable with diameter-optimised collar (Order no. 1333100000, pack of 500).

ZPE 2.5N/3AN

2.5 mm²

3 connections

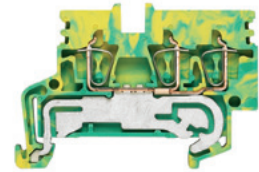

5.1 x 56.5 x 39	
/ 4	
0.05...4	

IEC 60947-7-2			II 2 G D
IEC	UL	CSA	
2.5	AWG 30...12	AWG 30...12	
800			
6			
	3		
	A2 / V-0		
Rated connection			
0.5...4 / 1.5...2.5			
0.5...2.5 / 0.5...1.5			
10 / 0.6 x 3.5 mm			
Note			
2.5 mm ² flexible wires with wire-end ferrules are crimped with the Weidmüller PZ 6/5 crimping tool.			

Type	Qty.	Order No.
ZPE 2.5N/3AN	50	1933770000

Type	Width	Qty.	Order No.
ZAP/TW ZDU/ZPE 2.5N/3AN	2 mm	50	1933800000
ZEW 35	6 mm	20	9540000000
ZTA ZT2.5	5.1 mm	25	1827080000
ZTA ZT2.5/ZA	5.1 mm	25	1847600000
SDIS SL 0.6X3.5X100		1	1274660000
ZRH 1.5H/1	4.85 mm	1000	1678810000
ZRH 1.5H/2	4.85 mm	1000	1678800000

DEK 5/5 / WS 10/5
2.5 mm ² wires with wire ferrules including the plastic collar only clampable with diameter-optimised collar (Order no. 1333100000, pack of 500).

ZPE 2.5N/4AN

2.5 mm²

4 connections



5.1 x 60 x 39
/ 4
0.05...4



IEC 60947-7-2

II 2 G D

IEC	UL	CSA
2.5	AWG 30...12	AWG 30...12
800		
6		
	3	
	A2 / V-0	



Rated connection

0.5...4 / 1.5...2.5

0.5...2.5 / 0.5...1.5

10 / 0.6 x 3.5 mm

2.5 mm² flexible wires with wire-end ferrules are crimped with the Weidmüller PZ 6/5 crimping tool.

Type	Qty.	Order No.
ZPE 2.5N/4AN	50	1933780000

Type	Width	Qty.	Order No.
ZAP/TW ZDU/ZPE 2.5N/4AN	2 mm	50	1933810000
ZEW 35	6 mm	20	9540000000
ZTA ZT2.5	5.1 mm	25	1827080000
ZTA ZT2.5/ZA	5.1 mm	25	1847600000
SDIS SL 0.6X3.5X100		1	1274660000
ZRH 1.5H/1	4.85 mm	1000	1678810000
ZRH 1.5H/2	4.85 mm	1000	1678800000

DEK 5/5 / WS 10/5

2.5 mm² wires with wire ferrules including the plastic collar only clampable with diameter-optimised collar (Order no. 1333100000, pack of 500).

PE terminals

Standard form

Z-series standard ranges provide solutions for conductor cross-sections from 0.05 to 35 mm².

In hazardous area applications, the installation instructions and the rated data specifications for accessories given in the technical appendix must be followed.

Width/Length/Height of lowest version	mm
max. current / max. cond. cross-section	A/mm ²
Max. clamping range	mm ²

Technical data

Rated data	
Rated cross-section	mm ²
Rated voltage to adjoining terminal	V
Rated impulse withstand voltage to adjacent terminal	kV
Pollution severity	
Gauge to IEC 60947-1 / Flammability class UL94	
Approvals	
Clamped conductors (H05V/H07V)	
Solid / stranded	mm ²
Flexible / Flexible with ferrule	mm ²
Stripping length / Blade size	mm/-
Note	

Ordering data

Version	green/yellow Wemid
Note	

Accessories

End bracket	Dark beige Wemid
Test adapter	Standard With assembly peg
Reducing sleeves	For conductors < 0.5 mm ² / AWG 20 For conductors < 1.0 mm ² / AWG 18
End plate / Partition plate	Dark beige Wemid
Screwdriver	Standard
Reducing sleeves	For conductors < 0.5 mm ² / AWG 20 For conductors < 1.0 mm ² / AWG 18

Identification systems	(see assortment in catalogue 7) Marking tags
Note	

ZDK 1.5 PE

1.5 mm²

Double-level terminal

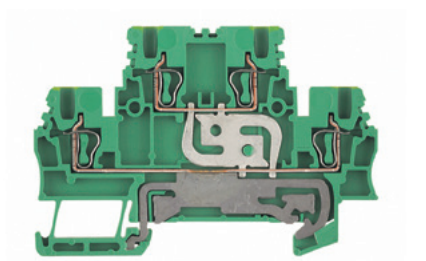

3.5 x 75.5 x 50 / 1.5 0.05...1.5	
--	--

IEC 60947-7-2	Ex e II		II 2 G D
IEC	UL	CSA	EN 60079-7
1.5	AWG 28...16	AWG 28...16	1.5
500			
6			
	3		
	B1 / V-0		
			KEMA 01ATEX2106 U
Rated connection			
0.5...1.5			
0.5...1.5 / 0.5...1.5			
10 / 0.4 x 2.0 mm			
Note			

Type	Qty.	Order No.
ZDK 1.5PE	100	1791150000
Note		

Type	Width	Qty.	Order No.
ZEW 35	6 mm	20	9540000000
ZTA 5	3.5 mm	25	1776210000
ZTA 5/ZA	3.5 mm	25	1776220000
ZRH 1.5S/1	4.55 mm	500	1781950000
ZRH 1.5S/2	4.55 mm	500	1781960000
ZAP/TW ZDK1.5	2 mm	20	1791160000
SDS 0.4X2.0X60		1	9037160000
ZRH 1.5S/1	4.55 mm	500	1781950000
ZRH 1.5S/2	4.55 mm	500	1781960000

Identification systems	(see assortment in catalogue 7) Marking tags
Note	

ZDK 2.5 PE

2.5 mm²

Vertically cross-connected

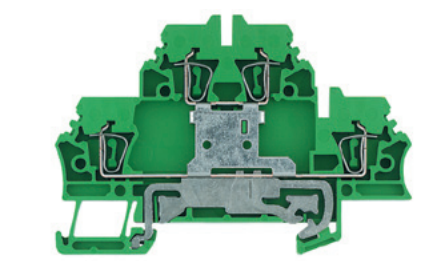

5.1 x 79.5 x 54 / 2.5 0.05...2.5	
--	--

IEC 60947-7-2	Ex e II		II 2 G D
IEC	UL	CSA	EN 60079-7
2.5	AWG 26...14	AWG 26...12	2.5
500			
6			
	3		
	A2 / V-0		
			KEMA 97ATEX4677 U
Rated connection			
0.5...2.5			
0.5...2.5 / 0.5...2.5			
10 / 0.6 x 3.5 mm			
2.5 mm ² flexible wires with wire-end ferrules are crimped with the Weidmüller PZ 6/5 crimping tool.			
Note			

Type	Qty.	Order No.
ZDK 2.5PE	50	1690000000
Note		

Type	Width	Qty.	Order No.
ZEW 35	6 mm	20	9540000000
ZTA 4	5.1 mm	25	1688110000
ZRH 1.5H/1	4.85 mm	1000	1678810000
ZRH 1.5H/2	4.85 mm	1000	1678800000
ZAP/TW ZDK2.5	1.5 mm	20	1674730000
SDIS SL 0.6X3.5X100		1	1274660000
ZRH 1.5H/1	4.85 mm	1000	1678810000
ZRH 1.5H/2	4.85 mm	1000	1678800000

Identification systems	(see assortment in catalogue 7) Marking tags
Note	

Roof-style

The compact terminal range for conductor cross-sections 0.13 to 16 mm².

In hazardous area applications, the installation instructions and the rated data specifications for accessories given in the technical appendix must be followed.

Width/Length/Height of lowest version	mm
max. current / max. cond. cross-section	A/mm ²
Max. clamping range	mm ²

Technical data

Rated data	
Rated cross-section	mm ²
Rated voltage to adjoining terminal	V
Rated impulse withstand voltage to adjacent terminal	kV
Rated short-time current	
Pollution severity	
Gauge to IEC 60947-1 / Flammability class UL94	
Approvals	
Clamped conductors (H05V/H07V)	
Solid / stranded	mm ²
Flexible / Flexible with ferrule	mm ²
Stripping length / Blade size	mm/-
Note	

Ordering data

Version	
	green/yellow Wemid
Note	

Accessories

End plate / Partition plate	
	Dark beige Wemid
End bracket	
	Dark beige Wemid
Test adapter	
	With assembly peg
Screwdriver	
	Standard
Reducing sleeves	
	For conductors < 0.5 mm ² / AWG 20
	For conductors < 1.0 mm ² / AWG 18

Identification systems	(see assortment in catalogue 7)
	Marking tags
Note	

ZDK 2.5-2 PE

2.5 mm²

Four connections



5.1 x 72.5 x 55.5	
/ 4	
0.05...4	

IEC 60947-7-2 II 2 G D

IEC	UL	CSA
2.5	AWG 26...12	AWG 30...12
800		
8		
	300 A (2.5 mm ²)	
	3	
	A2 / V-0	
Rated connection		
0.5...4		
0.5...2.5 / 0.5...1.5		
10 / 0.6 x 3.5 mm		
2.5 mm ² flexible wires with wire-end ferrules are crimped with the Weidmüller PZ 6/5 crimping tool.		

Type	Qty.	Order No.
ZDK 2.5-2PE	50	1791010000

Type	Width	Qty.	Order No.
ZAP/TW ZDK2.5-2	2 mm	20	1791050000
ZEW 35	6 mm	20	9540000000
ZTA 4	5.1 mm	25	1688110000
SDS 0.5X3.0X80		1	9008320000
ZRH 1.5H/1	4.85 mm	1000	1678810000
ZRH 1.5H/2	4.85 mm	1000	1678800000

Identification systems	
	DEK 5/5 / WS 10/5
Note	

ZDK 4-2 PE

4 mm²

Four connections



6.1 x 77.6 x 61	
/ 6	
0.13...6	

IEC 60947-7-2

IEC	UL	CSA
4	AWG 26...10	AWG 26...10
800		
8		
	480 A (4 mm ²)	
	3	
	A3 / V-0	
Rated connection		
0.5...6		
0.5...4 / 0.5...4		
10 / 0.6 x 3.5 mm		

Type	Qty.	Order No.
ZDK 4-2 PE	50	8671050000

Type	Width	Qty.	Order No.
ZAP/TW ZDK4-2	2 mm	50	8670760000
ZEW 35	6 mm	20	9540000000
ZTA 6/ZA	6.1 mm	25	1780660000
SDIS SL 0.6X3.5X100		1	1274660000

Identification systems	
	DEK 5/6
Note	

PE terminals

Compact style

ZDK 2.5/3AN PE

2.5 mm²

Double-level terminal



In hazardous area applications, the installation instructions and the rated data specifications for accessories given in the technical appendix must be followed.

Width/Length/Height of lowest version	mm
max. current / max. cond. cross-section	A/mm ²
Max. clamping range	mm ²

5.1 x 93 x 51.5
/ 4
0.05...4

Technical data

Rated data	
Rated voltage	V
Rated current	A
Rated cross-section	mm ²
Rated impulse withstand voltage / Pollution severity Gauge to IEC 60947-1 / Flammability class UL94	
Approvals	
Clamped conductors (H05V/H07V)	
Solid / stranded	mm ²
Flexible / Flexible with ferrule	mm ²
Stripping length / Blade size	mm/-
Note	

IEC 60947-7-2 II 2 G D

IEC	UL	CSA
800		300 (C)
		24 (C)
2.5	AWG 30...12	AWG 30...12
8 kV / 3		
A2 / V-0		

Rated connection	
0.5...4 / 0.5...2.5	
0.5...2.5 / 0.5...2.5	
10 / 0.6 x 3.5 mm	

2.5 mm² flexible wires with wire-end ferrules are crimped with the Weidmüller PZ 6/5 crimping tool.

Ordering data

Version	green/yellow Wemid
Note	

Type	Qty.	Order No.
ZDK 2.5/3AN PE	50	1924470000

Accessories

End plate / Partition plate	Dark beige Wemid
End bracket	Dark beige Wemid
Test adapter	Standard With assembly peg
Screwdriver	Standard
Reducing sleeves	Standard For conductors < 0.5 mm ² / AWG 20 For conductors < 1.0 mm ² / AWG 18

Type	Width	Qty.	Order No.
ZAP/TW ZDK 2.5/3AN	1.5 mm	20	1924910000
ZEW 35/2	8 mm	20	8630740000
ZTA ZT2.5	5.1 mm	25	1827080000
ZTA ZT2.5/ZA	5.1 mm	25	1847600000
SDIS SL 0.6X3.5X100		1	1274660000
ZRH 1.5H/1	4.85 mm	1000	1678810000
ZRH 1.5H/2	4.85 mm	1000	1678800000

Identification systems	(see assortment in catalogue 7) Marking tags
Note	

SNAPMARK I / DEK 5/5 / WS 10/5
2.5 mm ² wires with wire ferrules including the plastic collar only clampable with diameter-optimised collar (Order no. 1333100000, pack of 500).

Fuse terminals

Z-series standard ranges provide solutions for conductor cross-sections from 0.05 to 35 mm².

In hazardous area applications, the installation instructions and the rated data specifications for accessories given in the technical appendix must be followed.

Width/Length/Height of lowest version	mm
max. current / max. cond. cross-section	A/mm ²
Max. clamping range	mm ²

Technical data

Rated data	
Rated voltage to adjoining terminal	V
Rated current	A
Rated cross-section	mm ²
Rated impulse withstand voltage / Pollution severity	
Gauge to IEC 60947-1 / Flammability class UL94	
Approvals	
Clamped conductors (H05V/H07V)	
Solid / stranded	mm ²
Flexible / Flexible with ferrule	mm ²
Stripping length / Blade size	mm/-
Note	

Ordering data

Version	
	500 V AC/DC, w/o LED
	10-36 V AC/DC, with LED
	30-70 V AC/DC, with LED
	60-150 V AC/DC, with LED
	140-250 V AC/DC, with LED
Note	

Accessories

Pluggable cross-connection	
	2-pole
	3-pole
	4-pole
End plate / Partition plate	
	Dark beige Wemid
	Dark beige Wemid
Screwdriver	
	Standard
G-fuse cartridge, 5 x 20mm (IEC 60127-2)	
	0.25 A fast
	0.50 A fast
	1.00 A fast
	2.00 A fast
G25 with indicator / imperial (inch) fuse	
	0.50 A medium slow / 2 A
	1.00 A medium slow / 3 A
	2.00 A fast / 5 A
	4.00 A fast / 10 A

Identification systems	(see assortment in catalogue 7)
	Marking tags
Note	

ZSI 2.5

2.5 mm²

For metric fuses 5 x 20 mm

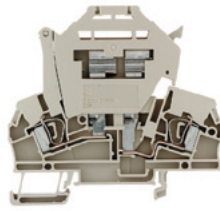

7.9 x 79.5 x 74
6.3 / 4
0.13...4

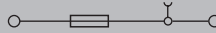

IEC 60947-7-3

	IEC	UL	CSA
	500	300 (C)	600 (C)
	6.3	10 (C)	15 (C)
	2.5	AWG 26...12	AWG 26...12
	6 kV / 3		
	A3 / V-0		
			
Rated connection			
	0.5...4		
	0.5...4 / 0.5...2.5		
	10 / 0.6 x 3.5 mm		
Max. power loss (1.6 W) at the cartridge fuse limits the rated current.			

Type	Qty.	Order No.
ZSI 2.5	50	1616400000
For the fuse insert carrier, the rated voltage is 250 V and the rated impulse voltage is 4 kV.		

Type	current	Qty.	Order No.
ZQV 6/2 GE	41 A	60	1627850000
ZQV 6/3 GE	41 A	60	1627860000
ZQV 6/4 GE	41 A	60	1627870000
Width			
ZAP/TW 3	2 mm	50	1608800000
ZAP TNHE/ZSI2.5	1.1 mm	25	1610840000
SDIS SL 0.6X3.5X100			
		1	1274660000
G 20/0.25A/F		10	0430500000
G 20/0.50A/F		10	0430600000
G 20/1.00A/F		10	0430700000
G 20/2.00A/F		10	0430900000

Identification systems	(see assortment in catalogue 7)
	Marking tags
Note	
	DEK 5/5 / WS 10/5
	Status display using a bi-directional LED.

ZSI 2.5

Overload and short-circuit protection

Type	Order No.			
ZSI 2.5	1616400000			
Arrangement				
	Applications			
	Only short-circuit protection		Overload and short-circuit protection	
	T_A max.	Nominal values	T_A max.	Nominal values
Individual	52 °C	4.0 W / 6.3 A	27 °C	2.5 W / 2.5 A
In combination	55 °C	2.5 W / 6.3 A	41 °C	1.6 W / 6.3 A

Z-series standard ranges provide solutions for conductor cross-sections from 0.05 to 35 mm².

In hazardous area applications, the installation instructions and the rated data specifications for accessories given in the technical appendix must be followed.

Width/Length/Height of lowest version	mm
max. current / max. cond. cross-section	A/mm ²
Max. clamping range	mm ²

Technical data

Rated data	
Rated voltage to adjoining terminal	V
Rated current	A
Rated cross-section	mm ²
Rated impulse withstand voltage / Pollution severity	
Gauge to IEC 60947-1 / Flammability class UL94	
Approvals	
Clamped conductors (H05V/H07V)	
Solid / stranded	mm ²
Flexible / Flexible with ferrule	mm ²
Stripping length / Blade size	mm/-
Note	

Ordering data

Version	
	500 V AC/DC, w/o LED
	10-36 V AC/DC, with LED
	30-70 V AC/DC, with LED
	60-150 V AC/DC, with LED
	140-250 V AC/DC, with LED
Note	

Accessories

Pluggable cross-connection	
	2-pole 3-pole 4-pole
End plate / Partition plate	
	Dark beige Wemid
	Dark beige Wemid
Screwdriver	
	Standard
G-fuse cartridge, 5 x 20mm (IEC 60127-2)	
	0.25 A fast
	0.50 A fast
	1.00 A fast
	2.00 A fast
G25 with indicator / imperial (inch) fuse	
	0.50 A medium slow / 2 A
	1.00 A medium slow / 3 A
	2.00 A fast / 5 A
	4.00 A fast / 10 A
Identification systems (see assortment in catalogue 7)	
	Marking tags
Note	

ZSI 2.5 LED

2.5 mm²

For metric fuses 5 x 20 mm

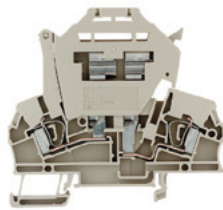

7.9 x 79.5 x 74
6.3 / 4
0.13...4

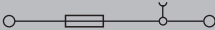

IEC 60947-7-3

IEC	UL	CSA
6.3		
2.5	AWG 26...12	AWG 26...12
6 kV / 3		
A3 / V-0		
Approvals		
Rated connection		
0.5...4		
0.5...4 / 0.5...2.5		
10 / 0.6 x 3.5 mm		
Note		
Max. power loss (1.6 W) at the cartridge fuse limits the rated current.		

Type	Qty.	Order No.
ZSI 2.5/LD 28AC	50	1616440000
ZSI 2.5/LD 60AC	50	1616430000
ZSI 2.5/LD 120AC	50	1616420000
ZSI 2.5/LD 250AC	50	1616410000
Note		
For the fuse insert carrier, the rated voltage is 250 V and the rated impulse voltage is 4 kV.		

ZSI 2.5/5x25

2.5 mm²

For metric fuses 5 x 25 mm

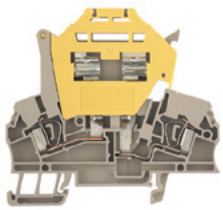

7.9 x 79.5 x 74
6.3 / 4
0.13...4

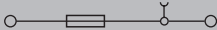

IEC 60947-7-3

IEC	UL	CSA
500		
6.3		
2.5		
6 kV / 3		
A3 / V-0		
Approvals		
Rated connection		
0.5...4		
0.5...4 / 0.5...2.5		
10 / 0.6 x 3.5 mm		
Note		
Max. power loss (1.6 W) at the cartridge fuse limits the rated current.		

Type	Qty.	Order No.
ZSI 2.5/5X25	50	1730900000
Note		
For the fuse insert carrier, the rated voltage is 250 V and the rated impulse voltage is 4 kV.		

Type	current	Qty.	Order No.
ZQV 6/2 GE	41 A	60	1627850000
ZQV 6/3 GE	41 A	60	1627860000
ZQV 6/4 GE	41 A	60	1627870000
Width			
ZAP/TW 3	2 mm	50	1608800000
ZAP TNHE/ZSI2.5	1.1 mm	25	1610840000
SDIS SL 0.6X3.5X100			
		1	1274660000
G 20/0.25A/F			
		10	0430500000
G 20/0.50A/F			
		10	0430600000
G 20/1.00A/F			
		10	0430700000
G 20/2.00A/F			
		10	0430900000

Type	current	Qty.	Order No.
ZQV 6/2 GE	41 A	60	1627850000
ZQV 6/3 GE	41 A	60	1627860000
ZQV 6/4 GE	41 A	60	1627870000
Width			
ZAP/TW 3	2 mm	50	1608800000
ZAP TNHE/ZSI2.5	1.1 mm	25	1610840000
SDIS SL 0.6X3.5X100			
		1	1274660000
G 25/0.50A/M WS			
		10	0510300000
G 25/1.00A/M RT			
		10	0265800000
G 25/2.00A/F BL			
		10	0192700000
G 25/4.00A/F BR			
		10	0192800000

DEK 5/5 / WS 10/5
Status display using a bi-directional LED.

DEK 5/5 / WS 10/5

Fuse terminals

Z-series standard ranges provide solutions for conductor cross-sections from 0.05 to 35 mm².

In hazardous area applications, the installation instructions and the rated data specifications for accessories given in the technical appendix must be followed.

Width/Length/Height of lowest version	mm
max. current / max. cond. cross-section	A/mm ²
Max. clamping range	mm ²

Technical data

Rated data	
Rated voltage to adjoining terminal	V
Rated current	A
Rated cross-section	mm ²
Rated impulse withstand voltage / Pollution severity	
Gauge to IEC 60947-1 / Flammability class UL94	
Approvals	
Clamped conductors (H05V/H07V)	
Solid / stranded	mm ²
Flexible / Flexible with ferrule	mm ²
Stripping length / Blade size	mm/-
Note	

Ordering data

Version	
	500 V AC/DC, w/o LED
	10-36 V AC/DC, with LED
	30-70 V AC/DC, with LED
	60-150 V AC/DC, with LED
	140-250 V AC/DC, with LED
Note	

Accessories

Pluggable cross-connection	
	2-pole
	3-pole
	4-pole
End plate / Partition plate	
	Dark beige Wemid
	Dark beige Wemid
Screwdriver	
	Standard
G-fuse cartridge, 5 x 20mm (IEC 60127-2)	
	0.25 A fast
	0.50 A fast
	1.00 A fast
	2.00 A fast
G25 with indicator / imperial (inch) fuse	
	0.50 A medium slow / 2 A
	1.00 A medium slow / 3 A
	2.00 A fast / 5 A
	4.00 A fast / 10 A

Identification systems	(see assortment in catalogue 7)
Note	Marking tags

ZSI 2.5/2

2.5 mm²

For imperial fuses



12.2 x 79.5 x 74
12 / 4
0.13...4

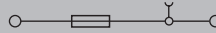

IEC 60947-7-3

IEC	UL	CSA
500	600 (C)	600 (C)
12	16 (C)	15 (C)
2.5	AWG 26...12	AWG 26...12
6 kV / 3		
A3 / V-0		



Rated connection	
	0.5...4
	0.5...4 / 0.5...2.5
	10 / 0.6 x 3.5 mm
Note	
Max. power loss (1.6 W) at the cartridge fuse limits the rated current.	

Type	Qty.	Order No.
ZSI 2.5/2 500AC	10	1616460000
Note		
For the fuse insert carrier, the rated voltage is 250 V and the rated impulse voltage is 4 kV.		

Type	current	Qty.	Order No.
ZQS 2.5/2	10 A	20	1633200000
ZQS 2.5/3	10 A	20	1633210000
ZQS 2.5/4	10 A	20	1633220000
Width			
ZAP TNHE/ZSI2.5	1.1 mm	25	1610840000
SDIS SL 0.6X3.5X100		1	1274660000
GZ 10.0A		10	0293900000

Identification systems	(see assortment in catalogue 7)
Note	DEK 5/5 / WS 10/5 Status display using a bi-directional LED. With use of inch fuse cartridges.

ZSI 2.5/2

Overload and short-circuit protection

Type	Order No.
ZSI 2.5/2 500AC	1616460000

Arrangement	Applications			
	Only short-circuit protection		Overload and short-circuit protection	
	T _A max.	Nominal values	T _A max.	Nominal values
Individual	46 °C	4.0 W / 10.0 A	40 °C	2.5 W / 2.5 A
In combination	72 °C	2.5 W / 2.5 A	29 °C	2.5 W / 2.5 A

Z-series standard ranges provide solutions for conductor cross-sections from 0.05 to 35 mm².

In hazardous area applications, the installation instructions and the rated data specifications for accessories given in the technical appendix must be followed.

Width/Length/Height of lowest version	mm
max. current / max. cond. cross-section	A/mm ²
Max. clamping range	mm ²

Technical data

Rated data	
Rated voltage to adjoining terminal	V
Rated current	A
Rated cross-section	mm ²
Rated impulse withstand voltage / Pollution severity	
Gauge to IEC 60947-1 / Flammability class UL94	
Approvals	
Clamped conductors (H05V/H07V)	
Solid / stranded	mm ²
Flexible / Flexible with ferrule	mm ²
Stripping length / Blade size	mm/-

Note

Ordering data

Version	
	500 V AC/DC, w/o LED
	10-36 V AC/DC, with LED
	30-70 V AC/DC, with LED
	60-150 V AC/DC, with LED
	140-250 V AC/DC, with LED

Note

Accessories

Pluggable cross-connection	
	2-pole
	3-pole
	4-pole

End plate / Partition plate	
	Dark beige Wemid
	Dark beige Wemid

Screwdriver	
	Standard

G-fuse cartridge, 5 x 20mm (IEC 60127-2)	
	0.25 A fast
	0.50 A fast
	1.00 A fast
	2.00 A fast

G25 with indicator / imperial (inch) fuse	
	0.50 A medium slow / 2 A
	1.00 A medium slow / 3 A
	2.00 A fast / 5 A
	4.00 A fast / 10 A

Identification systems	(see assortment in catalogue 7)
	Marking tags

Note

ZSI 2.5/2 LED

2.5 mm²

For imperial fuses



12.2 x 79.5 x 74
12 / 4
0.13...4



IEC 60947-7-3

IEC	UL	CSA
12		
2.5	AWG 26...12	AWG 26...12
	6 kV / 3	
	A3 / V-0	

IEC, UL, CSA, VDE, TÜV, CE, RoHS, REACH, A3, V-0

Rated connection
0.5...4
0.5...4 / 0.5...2.5
10 / 0.6 x 3.5 mm

Max. power loss (1.6 W) at the cartridge fuse limits the rated current.

Type	Qty.	Order No.
ZSI 2.5/2/LD 28AC	10	1616470000
ZSI 2.5/2/LD 60AC	10	1616480000
ZSI 2.5/2/LD 120AC	10	1616490000
ZSI 2.5/2/LD 250AC	10	1616500000

For the fuse insert carrier, the rated voltage is 250 V and the rated impulse voltage is 4 kV.

Type	current	Qty.	Order No.
ZQS 2.5/2	10 A	20	1633200000
ZQS 2.5/3	10 A	20	1633210000
ZQS 2.5/4	10 A	20	1633220000

Width			
ZAP TNHE/ZSI2.5	1.1 mm	25	1610840000
SDIS SL 0.6X3.5X100		1	1274660000

Type	current	Qty.	Order No.
GZ 10.0A		10	0293900000

DEK 5/5 / WS 10/5

Status display using a bi-directional LED. With use of inch fuse cartridges.

Fuse terminals

Z-series standard ranges provide solutions for conductor cross-sections from 0.05 to 35 mm².

In hazardous area applications, the installation instructions and the rated data specifications for accessories given in the technical appendix must be followed.

Width/Length/Height of lowest version	mm
max. current / max. cond. cross-section	A/mm ²
Max. clamping range	mm ²



Technical data

Rated data	
Rated voltage to adjoining terminal	V
Rated current	A
Rated cross-section	mm ²
Rated impulse withstand voltage / Pollution severity	
Gauge to IEC 60947-1 / Flammability class UL94	
Approvals	
Clamped conductors (H05V/H07V)	
Solid / stranded	mm ²
Flexible / Flexible with ferrule	mm ²
Stripping length / Blade size	mm/-
Note	

Ordering data

Version	
	500 V AC/DC, w/o LED
	10-36 V AC/DC, with LED
	60-150 V AC/DC, with LED
	140-250 V AC/DC, with LED
Note	

Accessories

Pluggable cross-connection	
	2-pole
	3-pole
	4-pole
End plate / Partition plate	
Screwdriver	Standard
G-fuse cartridge, 5 x 20mm (IEC 60127-2)	
	0.25 A fast
	0.50 A fast
	1.00 A fast
	2.00 A fast
G25 with indicator / imperial (inch) fuse	
	0.50 A medium slow / 2 A
	1.00 A medium slow / 3 A
	2.00 A fast / 5 A
	4.00 A fast / 10 A

Identification systems	(see assortment in catalogue 7)
Note	Marking tags

ZSI 2.5 2x2 AN

2.5 mm²

For metric fuses 5 x 20 mm / 5 x 25 mm

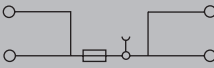

12.2 x 68 x 55.5	
10 / 4	
0.13...4	

IEC 60947-7-3

	IEC	UL	CSA
	500	300 (C)	300 (C)
	10	10 (C)	10 (C)
	2.5	AWG 26...12	AWG 26...12
	4 kV / 3		
	A3 / V-0		

Rated connection
0.5...4
0.5...4 / 0.5...2.5
10 / 0.6 x 3.5 mm
Note
The rated voltage of the fuse must not be exceeded. UL & CSA D = 600 V / 5 A

Type	Qty.	Order No.
ZSI 2.5-2/2X2AN/G20	20	1826050000
Note		
G 20 = G-fuse cartridge 5 x 20 / G 25 = G-fuse cartridge 5 x 25 G 25 LED versions upon request.		

Type	current	Qty.	Order No.
ZQV 4/2 GE	32 A	60	1608950000
	Width		
SDIS SL 0.6X3.5X100		1	1274660000
G 20/0.25A/F		10	0430500000
G 20/0.50A/F		10	0430600000
G 20/1.00A/F		10	0430700000
G 20/2.00A/F		10	0430900000
G 25/0.50A/M WS		10	0510300000
G 25/1.00A/M RT		10	0265800000
G 25/2.00A/F BL		10	0192700000
G 25/4.00A/F BR		10	0192800000

Note	DEK 5/5 / WS 10/5
	Status display via an LED.

ZSI 2.5-2

Overload and short-circuit protection

ZSI 2.5-2 / G20

Type	Order No.
ZSI 2.5-2/2X2AN/G20	1826050000
ZSI 2.5-2/2X2AN/G20/GL	1826030000

Arrangement	Applications			
	Only short-circuit protection		Overload and short-circuit protection	
	T _A max.	Nominal values	T _A max.	Nominal values
Individual			39 °C	2.5 W / 6.3 A
In combination			41 °C	1.6 W / 6.3 A

ZSI 2.5-2 / G25

Type	Order No.
ZSI 2.5-2/2X2AN/G25	1826200000
ZSI 2.5-2/2X2AN/G25/GL	1826090000

Arrangement	Applications			
	Only short-circuit protection		Overload and short-circuit protection	
	T _A max.	Nominal values	T _A max.	Nominal values
Individual	60 °C			
In combination	47 °C			

Z-series standard ranges provide solutions for conductor cross-sections from 0.05 to 35 mm².

In hazardous area applications, the installation instructions and the rated data specifications for accessories given in the technical appendix must be followed.

Width/Length/Height of lowest version	mm
max. current / max. cond. cross-section	A/mm ²
Max. clamping range	mm ²

Technical data



Rated data	
Rated voltage to adjoining terminal	V
Rated current	A
Rated cross-section	mm ²
Rated impulse withstand voltage / Pollution severity	
Gauge to IEC 60947-1 / Flammability class UL94	
Approvals	
Clamped conductors (H05V/H07V)	
Solid / stranded	mm ²
Flexible / Flexible with ferrule	mm ²
Stripping length / Blade size	mm/-

Note

Ordering data

Version	
	500 V AC/DC, w/o LED
	10-36 V AC/DC, with LED
	60-150 V AC/DC, with LED
	140-250 V AC/DC, with LED
Note	

Accessories

Pluggable cross-connection	
	2-pole
	3-pole
	4-pole
End plate / Partition plate	
Screwdriver	
	Standard
G-fuse cartridge, 5 x 20mm (IEC 60127-2)	
	0.25 A fast
	0.50 A fast
	1.00 A fast
	2.00 A fast
G25 with indicator / imperial (inch) fuse	
	0.50 A medium slow / 2 A
	1.00 A medium slow / 3 A
	2.00 A fast / 5 A
	4.00 A fast / 10 A

Identification systems	(see assortment in catalogue 7)
Note	Marking tags

ZSI 2.5 2x2 AN LED

2.5 mm²

For metric fuses 5 x 20 mm / 5 x 25 mm



12.2 x 65 x 55.5	
10 / 4	
0.13...4	

IEC 60947-7-3

IEC	UL	CSA
	300 (C)	
10	10 (C)	
2.5	AWG 26...12	AWG 26...12
	4 kV / 3	
	A3 / V-0	



Rated connection	
	0.5...4
	0.5...4 / 0.5...2.5
	10 / 0.6 x 3.5 mm

The rated voltage of the fuse must not be exceeded. UL & CSA D = 600 V / 5 A

Type	Qty.	Order No.
ZSI 2.5-2/2X2AN/G20/LD1	20	1867440000
ZSI 2.5-2/2X2AN/G20/LD3	20	1867420000
ZSI 2.5-2/2X2AN/G20/LD4	20	1879730000

G 20 = G-fuse cartridge 5 x 20 / G 25 = G-fuse cartridge 5 x 25
G 25 LED versions upon request.

Type	current	Qty.	Order No.
ZQV 4/2 GE	32 A	60	1608950000
Width			
SDIS SL 0.6X3.5X100			
		1	1274660000
G 20/0.25A/F			
		10	0430500000
G 20/0.50A/F			
		10	0430600000
G 20/1.00A/F			
		10	0430700000
G 20/2.00A/F			
		10	0430900000
G 25/0.50A/M WS			
		10	0510300000
G 25/1.00A/M RT			
		10	0265800000
G 25/2.00A/F BL			
		10	0192700000
G 25/4.00A/F BR			
		10	0192800000

Note	DEK 5/5 / WS 10/5
	Status display via an LED.

Fuse terminals

Z-series standard ranges provide solutions for conductor cross-sections from 0.05 to 35 mm².

In hazardous area applications, the installation instructions and the rated data specifications for accessories given in the technical appendix must be followed.

Width/Length/Height of lowest version	mm
max. current / max. cond. cross-section	A/mm ²
Max. clamping range	mm ²

Technical data

Rated data	
Rated voltage to adjoining terminal	V
Rated current	A
Rated cross-section	mm ²
Rated impulse withstand voltage / Pollution severity	
Gauge to IEC 60947-1 / Flammability class UL94	
Approvals	
Clamped conductors (H05V/H07V)	
Solid / stranded	mm ²
Flexible / Flexible with ferrule	mm ²
Stripping length / Blade size	mm/-
Note	

Ordering data

Version	
	500 V AC/DC, w/o LED
	10-36 V AC/DC, with LED
	60-150 V AC/DC, with LED
	140-250 V AC/DC, with LED
Note	

Accessories

Pluggable cross-connection	
	2-pole
	3-pole
	4-pole
End plate / Partition plate	
Screwdriver	Standard
G-fuse cartridge, 5 x 20mm (IEC 60127-2)	
	0.25 A fast
	0.50 A fast
	1.00 A fast
	2.00 A fast
	4.00 A fast
G25 with indicator / imperial (inch) fuse	
	0.50 A medium slow / 2 A
	1.00 A medium slow / 3 A
	2.00 A fast / 5 A
	4.00 A fast / 10 A

Identification systems	(see assortment in catalogue 7)
	Marking tags
Note	

ZSI 6-2

6 mm²

For metric fuses 5 x 20 mm / 5 x 25 mm



12.2 x 68 x 55.5	
10 / 10	
0.13...10	

IEC 60947-7-3

IEC	UL	CSA
500	300 (C)	300 (C)
10	10 (C)	10 (C)
6	AWG 26...12	AWG 26...8
4 kV / 3		
A3 / V-0		



Rated connection	
0.5...4	
0.5...4 / 0.5...2.5	
10 / 0.6 x 3.5 mm	
The rated voltage of the fuse must not be exceeded. Acc. to UL 600 V / 5 A. A3 terminal points AWG 26-12, A5 terminal points AWG 20-8.	

Type	Qty.	Order No.
ZSI 6-2 2X2.5/G20	20	1820930000
G 20 = G-fuse cartridge 5 x 20 / G 25 = G-fuse cartridge 5 x 25 G 25 LED versions upon request.		

Type	current	Qty.	Order No.
ZQV 6/2 GE	41 A	60	1627850000
Width			
SDIS SL 0.8X4.0X100		1	1274670000
G 20/0.25A/F		10	0430500000
G 20/0.50A/F		10	0430600000
G 20/1.00A/F		10	0430700000
G 20/2.00A/F		10	0430900000
G 25/0.50A/M WS		10	0510300000
G 25/1.00A/M RT		10	0265800000
G 25/2.00A/F BL		10	0192700000
G 25/4.00A/F BR		10	0192800000

DEK 5/5 / WS 10/5
Status display via an LED.

ZSI 6-2

Overload and short-circuit protection

ZSI 6-2 2x2.5 / G20

Type	Order No.
ZSI 6-2 2X2.5/G20	1820930000
ZSI 6-2 2X2.5/G20/GL	1820860000

Arrangement	Applications			
	Only short-circuit protection		Overload and short-circuit protection	
	T _A max.	Nominal values	T _A max.	Nominal values
Individual			37 °C	2.5 W / 6.3 A
In combination			40 °C	1.6 W / 6.3 A

ZSI 6 2x2.5 / G25

Type	Order No.
ZSI 6-2 2X2.5/G25	1820950000
ZSI 6-2 2X2.5/G25/GL	1820940000

Arrangement	Applications			
	Only short-circuit protection		Overload and short-circuit protection	
	T _A max.	Nominal values	T _A max.	Nominal values
Individual	60 °C			
In combination	47 °C			

Z-series standard ranges provide solutions for conductor cross-sections from 0.05 to 35 mm².

In hazardous area applications, the installation instructions and the rated data specifications for accessories given in the technical appendix must be followed.

Width/Length/Height of lowest version	mm
max. current / max. cond. cross-section	A/mm ²
Max. clamping range	mm ²

Technical data

Rated data	
Rated voltage to adjoining terminal	V
Rated current	A
Rated cross-section	mm ²
Rated impulse withstand voltage / Pollution severity	
Gauge to IEC 60947-1 / Flammability class UL94	
Approvals	
Clamped conductors (H05V/H07V)	
Solid / stranded	mm ²
Flexible / Flexible with ferrule	mm ²
Stripping length / Blade size	mm/-

Note

Ordering data

Version	500 V AC/DC, w/o LED 10-36 V AC/DC, with LED 60-150 V AC/DC, with LED 140-250 V AC/DC, with LED
Note	

Accessories

Pluggable cross-connection	2-pole 3-pole 4-pole
End plate / Partition plate	
Screwdriver	Standard
G-fuse cartridge, 5 x 20mm (IEC 60127-2)	0.25 A fast 0.50 A fast 1.00 A fast 2.00 A fast
G25 with indicator / imperial (inch) fuse	0.50 A medium slow / 2 A 1.00 A medium slow / 3 A 2.00 A fast / 5 A 4.00 A fast / 10 A

Identification systems	(see assortment in catalogue 7) Marking tags
Note	

ZSI 6-2 LED

6 mm²

For metric fuses 5 x 20 mm / 5 x 25 mm



12.2 x 65 x 55.5	
10 / 10	
0.13...10	

IEC 60947-7-3

IEC	UL	CSA
	300 (C)	
10	10 (C)	
6	AWG 26...12	AWG 20...8
	4 kV / 3	
	A3 / V-0	

Rated connection
0.5...10
0.5...10 / 0.5...6
10 / 0.6 x 3.5 mm

The rated voltage of the fuse must not be exceeded. Acc. to UL 600 V / 5 A. A3 terminal points AWG 26-12, A5 terminal points AWG 20-8.

Type	Qty.	Order No.
ZSI 6-2 2X2.5/G20/LD1	20	1867500000
ZSI 6-2 2X2.5/G20/LD4	20	1879750000

G 20 = G-fuse cartridge 5 x 20 / G 25 = G-fuse cartridge 5 x 25
G 25 LED versions upon request.

Type	current	Qty.	Order No.
ZQV 6/2 GE	41 A	60	1627850000
Width			
SDIS SL 0.8X4.0X100		1	1274670000
G 20/0.25A/F		10	0430500000
G 20/0.50A/F		10	0430600000
G 20/1.00A/F		10	0430700000
G 20/2.00A/F		10	0430900000
G 25/0.50A/M WS		10	0510300000
G 25/1.00A/M RT		10	0265800000
G 25/2.00A/F BL		10	0192700000
G 25/4.00A/F BR		10	0192800000

DEK 5/5 / WS 10/5
Status display via an LED.

Fuse terminals

Z-series standard ranges provide solutions for conductor cross-sections from 0.05 to 35 mm².

In hazardous area applications, the installation instructions and the rated data specifications for accessories given in the technical appendix must be followed.

Width/Length/Height of lowest version	mm
max. current / max. cond. cross-section	A/mm ²
Max. clamping range	mm ²



Technical data

Rated data	
Rated voltage to adjoining terminal	V
Rated current	A
Rated cross-section	mm ²
Rated impulse withstand voltage / Pollution severity	
Gauge to IEC 60947-1 / Flammability class UL94	
Approvals	
Clamped conductors (H05V/H07V)	
Solid / stranded	mm ²
Flexible / Flexible with ferrule	mm ²
Stripping length / Blade size	mm/-
Note	

Ordering data

Version	
	500 V AC/DC, w/o LED
	10-36 V AC/DC, with LED
	60-150 V AC/DC, with LED
	140-250 V AC/DC, with LED
Note	

Accessories

Pluggable cross-connection	
	2-pole
	3-pole
	4-pole
End plate / Partition plate	
Screwdriver	
	Standard
G-fuse cartridge, 5 x 20mm (IEC 60127-2)	
	0.25 A fast
	0.50 A fast
	1.00 A fast
	2.00 A fast
G25 with indicator / imperial (inch) fuse	
	0.50 A medium slow / 2 A
	1.00 A medium slow / 3 A
	2.00 A fast / 5 A
	4.00 A fast / 10 A

Identification systems	(see assortment in catalogue 7)
	Marking tags
Note	

ZSI 6-2/FC

6 mm²

For car fuses

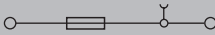

8.1 x 70 x 51	
30 / 10	
0.33...10	

DIN 72581-3, IEC 60947-7-3

IEC	UL	CSA
400		300 (C)
30		25 (C)
6	AWG 22...10	AWG 22...10
6 kV / 3		
A5 / V-0		

	
Rated connection	
0.5...10	
0.5...10 / 0.5...6	
10 / 4.0 x 0.8 mm	
Fuse continuous current max. 80 % IN.	

Type	Qty.	Order No.
ZSI 6-2/FC	25	1814690000
ZSI 6-2/FC LD	25	1814700000
Car fuses are not available from Weidmüller		

Type	current	Qty.	Order No.
ZQV 6/2 GE	41 A	60	1627850000
ZQV 6/3 GE	41 A	60	1627860000
ZQV 6/4 GE	41 A	60	1627870000
Width			
SDIS SL 0.8X4.0X100			
		1	1274670000

Identification systems	
	DEK 5/6 / WS 12/6
Note	
Status display using a bi-directional LED. With use of Pudenz fuses.	

ZSI 6-2/FC

Overload and short-circuit protection

Type	Order No.
ZSI 6-2/FC	1814690000

Arrangement	Applications			
	Only short-circuit protection		Overload	
	T _A max.	Nominal values	T _A max.	Nominal values
Individual	24 °C	3,0 W / 30 A	*	*
In combination	28 °C	1,90 W / 24 A (30 A)**	*	*

*) Values not available
 **) According to information from the manufacturer, the rated value of the fuse must be reduced to 80 % of the nominal value of the fuse. The permitted power loss is limited by the surface temperature of the fuse.
 => The 30 A fuse can be loaded to a maximum 24 A

Especially suitable for utility vehicles in combination with standard car fuses and thermal circuit breakers.

- Simple fuse protection for the plant or facility
- Simplifies the wiring by using ZQV cross-connections
- Simple distribution of potentials
- Vibration-proof
- Optimised wire insertion to connect short-circuit proof cables
- Pluggable solution for ETA circuit breaker (Typ 1170) or alternatively car fuses

ZSI 2x6/4x2.5 FC

6/2.5 mm²

**Circuit breaker ETA 1170
28 V DC**

NEW

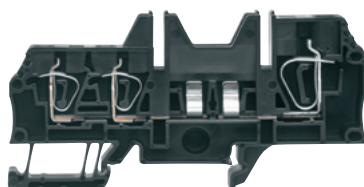

ZSI 2X6/4X2.5 FC / ZSI 2X6/4X2.5

Overload and short-circuit protection

Width/Length/Height with TS35x7.5	mm
Insulating stripping length	mm

16 / 93 / 47.5	
10	

Technical data

Rated data	
Rated voltage to adjoining terminal	V
Rated current	A
Rated cross-section	mm ²
Approvals	
Other technical data	
Clamped conductors	
solid H07V-U	mm ²
stranded H07V-K	mm ²
„f“ with ferrule acc. DIN 46 228/1	mm ²
„f“ ferrules with plastic collar	mm ²
max. clamping range in mm ²	
gauge acc. to IEC 60 947-1	Size
Note	

IEC	UL	CSA
500		
57		
2.5	AWG 26...12	AWG 26...12
6	AWG 20...8	AWG 20...8
	in work	in work
Output	Input	
0.5...4	0.5...10	
0.5...4	0.5...10	
0.5...2.5	0.5...6	
0.5...2.5	0.5...6	
	0.08...4	0.21...10
Note		
The maximum load of the single circuit breakers shouldn't be exceeded.		

Ordering data

Type	Qty.	Order No.
ZSI 2x6/4x2.5 FC	10	1058520000
Note		

Accessories

Pluggable cross-connection	
	2-pole
	3-pole
	4-pole
End plate / partition	
	ZAP black Wemid
Screwdriver	
	SD acc. to DIN 5264-A
Circuit breaker ETA and car fuses*	
Rated voltage	
Rated current	A
Switching capacity	A
Protection	IP
Rated current circuit breaker	A
ETA 1180	
ETA 1170	
Marking systems	
	(see assortment in catalogue 7)
	Marking tags
*) Note:	
not possible to order from Weidmüller	

Type	Current	Qty.	Order No.
ZQV 6/2 GE	41 A	60	1627850000
Circuit breaker 1170			
28 V DC			
3...25			
400			
40			
Circuit breaker 1170			
	Colour	Order No.	
3	violet	1278730000	
4	pink	1278740000	
5	orange	1278750000	
6	green	1278760000	
7.5	brown	1278770000	
8	yellow	1278780000	
10	red	1278790000	
15	blue	1278810000	
20	yellow	1278820000	
25	white	1278830000	
Marking systems			
	DEK 5/5 MC		
*) Note:			
not possible to order from Weidmüller			

Type	Order No.			
ZSI 2X6/4X2.5 FC	1058520000			
Arrangement				
Arrangement	Applications			
	ETA fuse		Automotive fuse	
	T _A max.	Nominal values	T _A max.	Nominal values
Individual	24 °C	1.68 W / 20 A (25 A)*	45 °C	1.9 W / 24 A (30 A)**
In combination	24 °C	1.68 W / 20 A (25 A)*	35 °C	1.9 W / 24 A (30 A)**
*) ETA circuit breakers 1170				
According to information from the manufacturer, the rated value of the fuse must be reduced to 80 % of the nominal value of the fuse. The permitted power loss is limited by the surface temperature of the fuse.				
⇒ The 25 A fuse can be loaded to a maximum 20 A				
**) Automotive fuses in accordance with DIN 41576				
According to information from the manufacturer, the rated value of the fuse must be reduced to 80 % of the nominal value of the fuse. The permitted power loss is limited by the surface temperature of the fuse.				
⇒ The 30 A fuse can be loaded to a maximum 24 A				

Fuse terminals

Especially suitable for utility vehicles in combination with standard car fuses and thermal circuit breakers.

- Simple fuse protection for the plant or facility
- Simplifies the wiring by using ZQV cross-connections
- Simple distribution of potentials
- Vibration-proof
- Optimised wire insertion to connect short-circuit proof cables
- Pluggable solution for ETA circuit breaker (Typ 1180)

Width/Length/Height with TS35x7.5	mm
Insulating stripping length	mm

Technical data

Rated data	
Rated voltage to adjoining terminal	V
Rated current	A
Rated cross-section	mm ²
Approvals	
Other technical data	
Clamped conductors	
solid H07V-U	mm ²
stranded H07V-K	mm ²
„f“ with ferrule acc. DIN 46 228/1	mm ²
„f“ ferrules with plastic collar	mm ²
max. clamping range in mm ²	
gauge acc. to IEC 60 947-1	Size

Note

Ordering data

Note

Accessories

Pluggable cross-connection	
	2-pole
	3-pole
	4-pole
End plate / partition	
	ZAP black Wemid
Screwdriver	
	SD acc. to DIN 5264-A
Circuit breaker ETA and car fuses*	
Rated voltage	
Rated current	A
Switching capacity	A
Protection	IP
Rated current circuit breaker	A

ETA 1180 ETA 1170

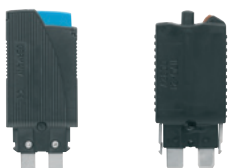

Marking systems (see assortment in catalogue 7)
Marking tags

***) Note:**
not possible to order from Weidmüller

ZSI 2x6/4x2.5

6/2.5 mm²

Circuit breaker ETA 1180
65 V DC / 250 V AC

NEW

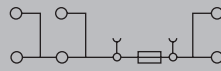
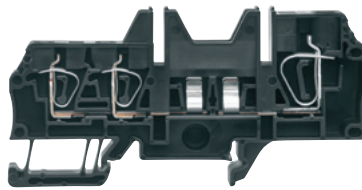

IEC	UL	CSA
500		
57		
2.5	AWG 26...12	AWG 26...12
6	AWG 20...8	AWG 20...8
	in work	in work
Output	Input	
0.5...4	0.5...10	
0.5...4	0.5...10	
0.5...2.5	0.5...6	
0.5...2.5	0.5...6	
0.08...4	0.21...10	

The maximum load of the single circuit breakers shouldn't be exceeded.

Type	Qty.	Order No.
ZSI 2x6/4x2.5	10	1265990000

Type	Strom	Qty.	Order No.
ZQV 6/2 GE	41 A	60	1627850000
ZAP ZSI2x6/4x2.5		50	1059310000
SD 0.6x3.5		1	9008330000
SD 0.8x4		1	9008340000

Circuit breaker 1180			
65 V DC / 250 V AC			
0.1...10			
400			
40			

Circuit breaker 1180			
	Order No.		Order No.
0.1	1278840000	2	1278970000
0.2	1278850000	2.5	1278980000
0.25	1278860000	3	1278990000
0.3	1278870000	3.5	1279010000
0.4	1278880000	4	1279020000
0.5	1278910000	5	1279030000
0.6	1278920000	6	1279040000
0.7	1278930000	7	1279050000
0.8	1278940000	8	1279060000
1	1278950000	10	1279070000
1.5	1278960000		

DEK 5/5 MC

ZSI 2X6/4X2.5 FC / ZSI 2X6/4X2.5

Overload and short-circuit protection

Type	Order No.
ZSI 2X6/4X2.5	1265990000

Arrangement	Applications			
	ETA fuse		Automotive fuse	
	T _A max.	Nominal values	T _A max.	Nominal values
Individual	24 °C	1.68 W / 20 A (25 A)*	45 °C	1.9 W / 24 A (30 A)**
In combination	24 °C	1.68 W / 20 A (25 A)*	35 °C	1.9 W / 24 A (30 A)**

***)** ETA circuit breakers 1170
According to information from the manufacturer, the rated value of the fuse must be reduced to 80 % of the nominal value of the fuse. The permitted power loss is limited by the surface temperature of the fuse.
⇒ The 25 A fuse can be loaded to a maximum 20 A

****)** Automotive fuses in accordance with DIN 41576
According to information from the manufacturer, the rated value of the fuse must be reduced to 80 % of the nominal value of the fuse. The permitted power loss is limited by the surface temperature of the fuse.
⇒ The 30 A fuse can be loaded to a maximum 24 A

Cartridge fuses and gauge pieces for Weidmüller fuse terminals

Cartridge fuses

For terminal type

ZSI 2.5
ZSI 6-2 2 x 2.5/G20...
ZSI 2.5 2 x 2 AN/G20...



Technical data / Ordering data

G-type cartridge fuses 5 x 20 without indicators to IEC 60127-2 (VDE 0820 pt.2 BI¹⁾)

Size (mm)	Nom. current (A)	Type	Qty.	Order No.
5 x 20 breaking capacity 1500 A (at 250 V, 50 Hz, cos φ 0.7)	0.1	(F) G 20/0.10A/F	10	0430300000
	0.2	(F) G 20/0.20A/F	10	0430400000
	0.25	(F) G 20/0.25A/F	10	0430500000
	0.5	(F) G 20/0.50A/F	10	0430600000
	0.63	(F) G 20/0.63A/F	10	0439000000
	1.0	(F) G 20/1.00A/F	10	0430700000
	1.6	(F) G 20/1.60A/F	10	0430800000
	2.0	(F) G 20/2.00A/F	10	0430900000
	2.5	(F) G 20/2.50A/F	10	0431000000
	3.15	(F) G 20/3.15A/F	10	0431100000
	4.0	(F) G 20/4.00A/F	10	0431200000
	5.0	(F) G 20/5.00A/F	10	0431300000
	6.3	(F) G 20/6.30A/F	10	0431400000

(M) = medium-blow (F) = fast-blow

G-type cartridge fuses 5 x 25 with indicators to DIN 41576¹⁾

ZSI 2.5/ 5 x 25
ZSI 6-2 2 x 2.5/G25...
ZSI 2.5 2 x 2 AN/G25...



5 x 25 m. K.1) breaking capacity 80 A (at 250 V, 50 Hz, cos : = 1)	0.25	(M) G 25/0.25A/M	10	0546900000
	0.5	(M) G 25/0.50A/M	10	0510300000
	0.8	(M) G 25/0.80A/M	10	0646400000
	1	(M) G 25/1.00A/M	10	0265800000
	10	(M) ²⁾ G 25/10.0A/M	10	0193100000
	2	(F) G 25/2.00A/F	10	0192700000
	4	(F) G 25/4.00A/F	10	0192800000
	6.3	(F) G 25/6.30A/F	10	0192900000

(M) = medium-blow (F) = fast-blow

Cartridge fuses 1/4" x 1/4" without indicators to BS 88

ZSI 2.5/2



33 kA breaking capacity 33 kA fast-blow	E 0.5	A	GZ 0.5A/F	10	0533800000
	E 1	A	GZ 1.0A/F	10	0525500000
	E 2	A	GZ 2.0A	10	0294500000
	E 3	A	GZ 3.0A	10	0295700000
	E 5	A	GZ 5.0A	10	0294600000
	E 7	A	GZ 7.0A	10	0295800000
	E 10	A	GZ 10.0A	10	0293900000
	E 10	A	GZ 12.5A FF	10	0245400000

(M) = medium-blow (F) = fast-blow

Note: ¹⁾ The SIBA company also supplies G-type cartridge fuses 5 x 25 with indicators suitable for 450 V~ shipbuilding applications.

Test-disconnect terminals

Standard model and Roof-style

Z-series standard ranges provide solutions for conductor cross-sections from 0.05 to 35 mm².

In hazardous area applications, the installation instructions and the rated data specifications for accessories given in the technical appendix must be followed.

Width/Length/Height of lowest version	mm
max. current / max. cond. cross-section	A/mm ²
Max. clamping range	mm ²

Technical data

Rated data	
Rated voltage	V
Rated current	A
Rated cross-section	mm ²
Rated impulse withstand voltage / Pollution severity	
Gauge to IEC 60947-1 / Flammability class UL94	
Approvals	
Clamped conductors (H05V/H07V)	
Solid / stranded	mm ²
Flexible / Flexible with ferrule	mm ²
Stripping length / Blade size	mm/-
Note	

Ordering data

Version	
	Dark beige Wemid
	Blue Wemid
	Without isolator, Dark beige Wemid
	Orange Wemid
Note	

Accessories

Pluggable cross-connection	
	2-pole
	3-pole
	4-pole
	10-pole
End plate / Partition plate	
	Dark beige Wemid
End bracket	
	Dark beige Wemid
Screwdriver	
	Standard
Testing / Checking	
	Test plug
Holder for cartridge fuse 5 x 20mm	
	400 V AC/DC, without LED
	10 - 36 V AC/DC, red LED
	140 - 250 V AC/DC, red LED
Module connector (max. 250 V)	
	without fittings
	with wire jumper
	With 1N4007 diode
Test adapter	
	Standard
	With assembly peg
Disconnect plug	
	removable, as replacement for release lever
Identification systems	
	(see assortment in catalogue 7)
	Marking tags
Note	

ZTR 2.5

2.5 mm²

Two connections

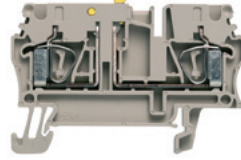

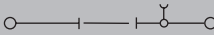
5.1 x 59.5 x 41	
20 / 4	
0.05...4	

IEC 60947-7-1

IEC	UL	CSA
500	600 (C)	600 (C)
20	20 (C)	15 (C)
2.5	AWG 30...12	AWG 30...12
6 kV / 3		
A3 / V-0		

Rated connection	
0.5...4	
0.5...4 / 0.5...2.5	
10 / 0.6 x 3.5 mm	
2.5 mm ² flexible wires with wire-end ferrules are crimped with the Weidmüller PZ 6/5 crimping tool.	

Type	Qty.	Order No.
ZTR 2.5	100	1831280000
ZTR 2.5 BL	100	8731710000
ZTR 2.5/O.TNHE	100	1831130000
ZTR 2.5 OR	100	8731680000

Type	current	Qty.	Order No.
ZQV 2.5/2	24 A	60	1608860000
ZQV 2.5/3	24 A	60	1608870000
ZQV 2.5/4	24 A	60	1608880000
ZQV 2.5/10	24 A	20	1608940000
Width			
ZAP/TW 1	2 mm	50	1608740000
ZEW 35	6 mm	20	9540000000
SDIS SL 0.6X3.5X100		1	1274660000
PS 2.3 RT	5.4 mm	20	0180400000
SIHA 3/G20	5.95 mm	25	7921560000
SIHA 3/G20/LD 10-36V	5.95 mm	25	7921570000
SIHA 3/G20/LD 140-250V	5.95 mm	25	7921600000
BEST	5.1 mm	50	1833100000
BEST/DRBR	5.1 mm	50	1878570000
BEST/D	5.1 mm	50	1878560000
ZTA 1	5.1 mm	25	1609040000
ZTA 1/ZA	5.1 mm	25	1609050000
TNST		50	1833090000

DEK 5/5 / WS 10/5
If the disconnect lever is replaced by the SIHA 3, a fused terminal is created.

ZTR 2.5/3AN

2.5 mm²

Three connections

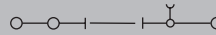

5.1 x 79.5 x 41	
20 / 4	
0.05...4	

IEC 60947-7-1

IEC	UL	CSA
500	600 (C)	300 (C)
20	20 (C)	10 (C)
2.5	AWG 30...12	AWG 26...12
6 kV / 3		
A3 / V-0		

Rated connection	
0.5...4	
0.5...4 / 0.5...2.5	
10 / 0.6 x 3.5 mm	
2.5 mm ² flexible wires with wire-end ferrules are crimped with the Weidmüller PZ 6/5 crimping tool.	

Type	Qty.	Order No.
ZTR 2.5/3AN	100	8731720000
ZTR 2.5/3AN BL	100	8731730000
ZTR 2.5/3AN/O.TNHE	100	8728450000
ZTR 2.5/3AN OR	100	8731690000

Type	current	Qty.	Order No.
ZQV 2.5/2	24 A	60	1608860000
ZQV 2.5/3	24 A	60	1608870000
ZQV 2.5/4	24 A	60	1608880000
ZQV 2.5/10	24 A	20	1608940000
Width			
ZAP/TW 3	2 mm	50	1608800000
ZEW 35	6 mm	20	9540000000
SDIS SL 0.6X3.5X100		1	1274660000
PS 2.3 RT	5.4 mm	20	0180400000
SIHA 3/G20	5.95 mm	25	7921560000
SIHA 3/G20/LD 10-36V	5.95 mm	25	7921570000
SIHA 3/G20/LD 140-250V	5.95 mm	25	7921600000
BEST	5.1 mm	50	1833100000
BEST/DRBR	5.1 mm	50	1878570000
BEST/D	5.1 mm	50	1878560000
ZTA 1	5.1 mm	25	1609040000
ZTA 1/ZA	5.1 mm	25	1609050000
TNST		50	1833090000

DEK 5/5 / WS 10/5
If the disconnect lever is replaced by the SIHA 3, a fused terminal is created.

ZTR 2.5/4AN

2.5 mm²

Four connections

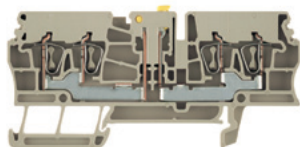

5.1 x 82.5 x 41
16 / 2.5
0.05...2.5



IEC 60947-7-1

IEC	UL	CSA
400	300 (D)	300 (C)
16	10 (D)	10 (C)
2.5	AWG 30...12	AWG 26...12
6 kV / 3		
A2 / V-0		



Rated connection

0.5...2.5
0.5...2.5 / 0.5...1.5
10 / 0.6 x 3.5 mm

2.5 mm² flexible wires with wire-end ferrules are crimped with the Weidmüller PZ 6/5 crimping tool.

Type	Qty.	Order No.
ZTR 2.5/4AN	100	7920900000
ZTR 2.5/4AN BL	100	7920930000
ZTR 2.5/4AN/O.TNHE	100	7920950000
ZTR 2.5/4AN OR	100	7920940000

Type	current	Qty.	Order No.
ZQV 2.5/2	24 A	60	1608860000
ZQV 2.5/3	24 A	60	1608870000
ZQV 2.5/4	24 A	60	1608880000
ZQV 2.5/10	24 A	20	1608940000
Width			
ZAP/TW 3	2 mm	50	1608800000
ZEW 35	6 mm	20	9540000000
SDIS SL 0.6X3.5X100		1	1274660000
PS 2.3 RT	5.4 mm	20	0180400000
SIHA 3/G20	5.95 mm	25	7921560000
SIHA 3/G20/LD 10-36V	5.95 mm	25	7921570000
SIHA 3/G20/LD 140-250V	5.95 mm	25	7921600000
BEST	5.1 mm	50	1833100000
BEST/DRBR	5.1 mm	50	1878570000
BEST/D	5.1 mm	50	1878560000
TNST		50	1833090000

WS 10/5 / DEK 5/5

If the disconnect lever is replaced by the SIHA 3, a fused terminal is created.

ZDTR 2.5

2.5 mm²

Four connections

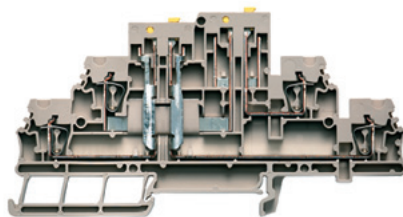

5.1 x 117 x 68
16 / 4
0.13...4

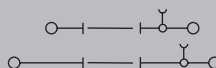

IEC 60947-7-1

IEC	UL	CSA
400	300 (D)	300 (B)
16	10 (D)	10 (B)
2.5	AWG 26...12	AWG 26...12
6 kV / 3		
A2 / V-0		



Rated connection

0.5...4
0.5...4 / 0.5...2.5
10 / 0.6 x 3.5 mm

2.5 mm² flexible wires with wire-end ferrules are crimped with the Weidmüller PZ 6/5 crimping tool.

Type	Qty.	Order No.
ZDTR 2.5	20	1745400000
ZDTR 2.5 BL	20	1798330000

Type	current	Qty.	Order No.
ZQV 2.5N/2 GE	24 A	60	1693800000
ZQV 2.5N/3 GE	24 A	60	1693810000
ZQV 2.5N/4 GE	24 A	60	1693820000
ZQV 2.5N/10 GE	24 A	20	1693880000
Width			
AP ZDTR2.5	1.5 mm	20	1745420000
ZEW 35	6 mm	20	9540000000
SDIS SL 0.6X3.5X100		1	1274660000
PS 2.3 RT	5.4 mm	20	0180400000
SIHA 2/G20 10-36V	5.95 mm	25	9543070000
SIHA 2/G20 140-250V	5.95 mm	25	9537640000
BEST	5.1 mm	50	1833100000
BEST/DRBR	5.1 mm	50	1878570000
BEST/D	5.1 mm	50	1878560000

DEK 5/5

If the disconnect lever is replaced by the SIHA 3 (only on the top level), a fused terminal is created.

Test-disconnect terminals

Test-disconnect terminal blocks for measuring with ZTL 6

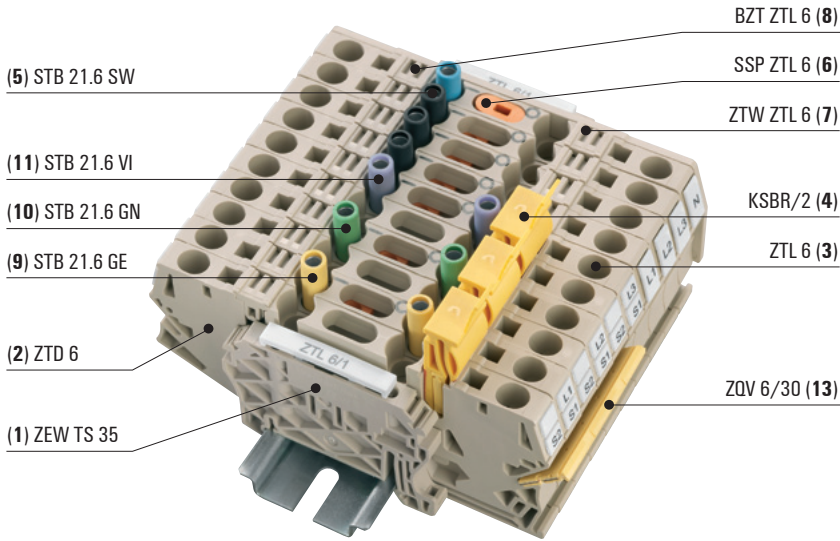

Pos.	Type	Qty.	Order No.
1	ZEW TS 35 (nur TS 35)	20	954000000
1	EWK1 (nur TS 32)	50	0206160000
2	ZTD 6	20	1771810000
3	ZTL 6	20	1771800000
4	KSBR/2	50	1771820000
5	STB 21.6 SW	50	1071040000
6	SSP ZTL 6	100	1771860000
7	ZTW ZTL 6	20	1771870000
8	BZT ZTL 6	20	1781140000

Optionally available for better labelling (instead of 11 x Pos. 5):

Pos.	Type	Qty.	Order No.
5	STB 21.6 BE	50	1071000000
9	STB 21.6 GE	50	1071010000
10	STB 21.6 GN	50	1071020000
11	STB 21.6 VI	50	1071030000
12	STB 21.6 BL	50	1071080000

Optionally available for a shared k-point:

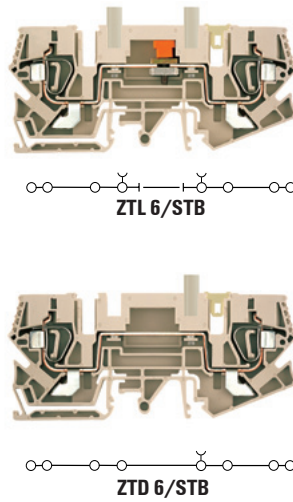

Operating status
(with internal distribution of the k-point)

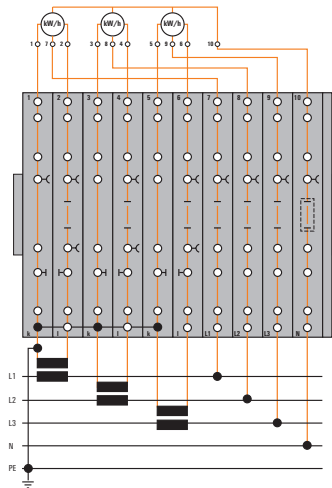

Comparison measurement for L1

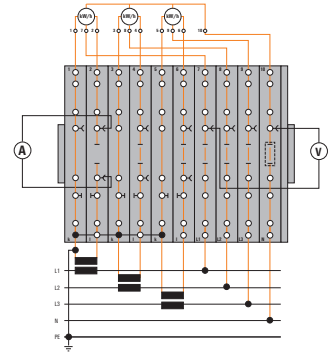

- Operation depending on the operating status:
1. Connect ammeter to test sockets of terminal 2.
 2. Open disconnect slide link of terminal 2.
 3. Connect voltameter to test sockets of terminals 7 and 10.

Meter test for L1 through external power supply

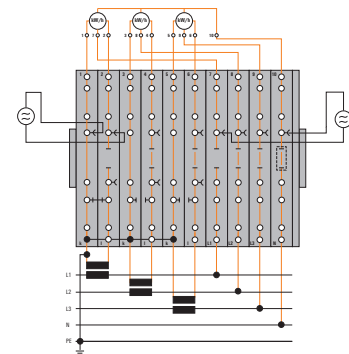

- Operation depending on the operating status:
1. Close short-circuit slide of terminals 1 and 2.
 2. Open disconnect slide link of terminals 2 and 7.
 3. Connect external power supply to the sockets of terminals 1, 2 and 7, 10.

Changing the meter for L1

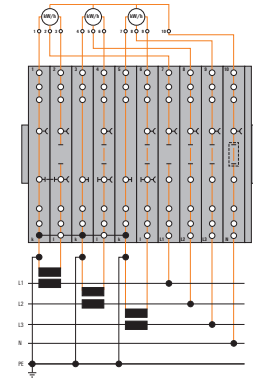

- Operation depending on the operating status:
1. Close short-circuit slide of terminals 1 and 2.
 2. Open disconnect slide link of terminals 2 and 7.
 3. Disconnect meter for L1 at terminals 1, 2 and 7.

Terminal for power supply

In hazardous area applications, the installation instructions and the rated data specifications for accessories given in the technical appendix must be followed.

Width/Length/Height of lowest version	mm
max. current / max. cond. cross-section	A/mm ²
Max. clamping range	mm ²

Technical data

Rated data	
Rated voltage	V
Rated current	A
Rated cross-section	mm ²
Rated impulse withstand voltage / Pollution severity Gauge to IEC 60947-1 / Flammability class UL94	
Approvals	
Clamped conductors (H05V/H07V)	
Solid / stranded	mm ²
Flexible / Flexible with ferrule	mm ²
Stripping length / Blade size	mm/-
Note	

Ordering data

Version	
	Without socket
	with socket
Note	

Accessories

Pluggable cross-connection	
	2-pole
	3-pole
	4-pole
End plate / Partition plate	
	End plate
Testing / Checking	
	Test plug
	Socket - blue
	Socket - yellow
	Socket - green
	Socket - magenta
Miscellaneous accessories	
	Lockout device
	Short-circuit plug, 2-pole
	Short-circuit plug, 3-pole
	Short-circuit plug, 4-pole
Marker holder	

Identification systems	
	(see assortment in catalogue 7)
	Marking tags
Note	

ZTD 6

6 mm²

Feed-through terminal

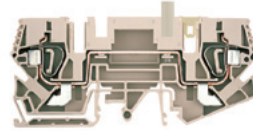

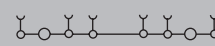
8 x 106 x 48	
52 / 10	
0.5...10	

IEC 60947-7-1

IEC	UL	CSA
800	300 (C)	300 (C)
41	33 (C)	33 (C)
6	AWG 20...8	AWG 20...8
8 kV / 3		
A5 / V-0		
Rated connection		
0.5...10 / 1.5...6		
0.5...6 / 0.5...6		
13 / 0.8 x 4.0 mm		
Note		
400 V when used as a disconnect terminal. Tightening torque for ZTD 6 disconnection element with screw = 0.5 - 0.6 Nm.		

Type	Qty.	Order No.
ZTD 6	20	1771810000
ZTD 6/STB	20	1771960000

Type	current	Qty.	Order No.
ZQV 6/2 GE	41 A	60	1627850000
ZQV 6/3 GE	41 A	60	1627860000
ZQV 6/4 GE	41 A	60	1627870000
Width			
ZTW ZTL6	2 mm	20	1771870000
Testing / Checking			
PS 4 F.STB 4	7.6 mm	20	0299600000
STB 21.6/IH/BL WTL6/3	6.2 mm	50	1071080000
STB 21.6/IH/GE WTL6/3	6.2 mm	50	1071010000
STB 21.6/IH/GN WTL6/3	6.2 mm	50	1071020000
STB 21.6/IH/VI WTL6/3	6.2 mm	50	1071030000
Miscellaneous accessories			
KSBR/2 ZTL6	13.7 mm	20	1771820000
KSBR/3 ZTL6	23.2 mm	20	1771830000
KSBR/4 ZTL6	31.3 mm	20	1771840000
Marker holder			
BZT ZTL6	7.8 mm	20	1781140000

Identification systems	
	(see assortment in catalogue 7)
	Marking tags
Note	
DEK 5/8 / WS 12/6,5	
Pluggable label holders for additional labelling tags are above the cross-connection channel (BZT ZTL 6).	

ZTL 6

6 mm²

Disconnect test terminal

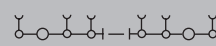

8 x 106 x 48	
52 / 10	
0.5...10	

IEC 60947-7-1

IEC	UL	CSA
800	300 (C)	300 (C)
41	33 (C)	33 (C)
6	AWG 20...8	AWG 20...8
8 kV / 3		
A5 / V-0		
Rated connection		
0.5...10 / 1.5...6		
0.5...6 / 0.5...6		
13 / 0.8 x 4.0 mm		
Note		
400 V when used as a disconnect terminal. Tightening torque for ZTL 6 disconnection element with screw = 0.5 - 0.6 Nm.		

Type	Qty.	Order No.
ZTL 6	20	1771800000
ZTL 6/STB	20	1771950000

Type	current	Qty.	Order No.
ZQV 6/2 GE	41 A	60	1627850000
ZQV 6/3 GE	41 A	60	1627860000
ZQV 6/4 GE	41 A	60	1627870000
Width			
ZTW ZTL6	2 mm	20	1771870000
Testing / Checking			
PS 4 F.STB 4	7.6 mm	20	0299600000
STB 21.6/IH/BL WTL6/3	6.2 mm	50	1071080000
STB 21.6/IH/GE WTL6/3	6.2 mm	50	1071010000
STB 21.6/IH/GN WTL6/3	6.2 mm	50	1071020000
STB 21.6/IH/VI WTL6/3	6.2 mm	50	1071030000
Miscellaneous accessories			
SSP ZTL6	6 mm	100	1771860000
KSBR/2 ZTL6	13.7 mm	20	1771820000
KSBR/3 ZTL6	23.2 mm	20	1771830000
KSBR/4 ZTL6	31.3 mm	20	1771840000
Marker holder			
BZT ZTL6	7.8 mm	20	1781140000

Identification systems	
	(see assortment in catalogue 7)
	Marking tags
Note	
DEK 5/8 / WS 12/6,5	
Pluggable label holders for additional labelling tags are above the cross-connection channel (BZT ZTL 6).	

Test-disconnect terminals

Standard model and Roof-style

The compact terminal range for conductor cross-sections 0.13 to 16 mm.

In hazardous area applications, the installation instructions and the rated data specifications for accessories given in the technical appendix must be followed.

Width/Length/Height of lowest version	mm
max. current / max. cond. cross-section	A/mm ²
Max. clamping range	mm ²

Technical data

Rated data	
Rated voltage	V
Rated current	A
Rated cross-section	mm ²
Rated impulse withstand voltage / Pollution severity	
Gauge to IEC 60947-1 / Flammability class UL94	
Approvals	
Clamped conductors (H05V/H07V)	
Solid / stranded	mm ²
Flexible / Flexible with ferrule	mm ²
Stripping length / Blade size	mm/-
Note	

Ordering data

Version	
	Dark beige Wemid
	Blue Wemid
	Without isolator, Dark beige Wemid
	Orange Wemid
Note	

Accessories

Pluggable cross-connection	
	2-pole
	3-pole
	4-pole
	10-pole
	20-/24-pole
End plate / Partition plate	
	Dark beige Wemid
End bracket	
	Dark beige Wemid
Screwdriver	
	Standard
Holder for cartridge fuse 5 x 20mm	
	400 V AC/DC, without LED
	10 - 36 V AC/DC, red LED
	140 - 250 V AC/DC, red LED
Module connector (max. 250 V)	
	without fittings
	with wire jumper
	With 1N4007 diode
Disconnect plug	
	removable, as replacement for release lever
Identification systems	
	(see assortment in catalogue 7)
	Marking tags
Note	

ZTR 2.5-2

2.5 mm²

Two connections



5.1 x 50.5 x 44
21 / 2.5
0.13...2.5

IEC 60947-7-1

IEC	UL	CSA
400	300 (D)	300 (C)
10	10 (D)	10 (C)
2.5	AWG 26...12	AWG 26...12
6 kV / 3		
A2 / V-0		
Rated connection		
0.5...2.5		
0.5...2.5 / 0.5...1.5		
10 / 0.6 x 3.5 mm		
2.5 mm ² flexible wires with wire-end ferrules are crimped with the Weidmüller PZ 6/5 crimping tool.		

Type	Qty.	Order No.
ZTR 2.5-2	100	1779010000
ZTR 2.5-2 BL	100	1779120000
ZTR 2.5-2/0.TNHE	100	1779020000
ZTR 2.5-2 OR	100	1779130000

Type	current	Qty.	Order No.
ZQV 2.5/2	24 A	60	1608860000
ZQV 2.5/3	24 A	60	1608870000
ZQV 2.5/4	24 A	60	1608880000
ZQV 2.5/10	24 A	20	1608940000
Width			
ZAP/TW7	2.5 mm	50	1706110000
ZEW 35			
	6 mm	20	9540000000
SDIS SL 0.6X3.5X100			
		1	1274660000
SIHA 3/G20	5.95 mm	25	7921560000
SIHA 3/G20/LD 10-36V	5.95 mm	25	7921570000
SIHA 3/G20/LD 140-250V	5.95 mm	25	7921600000
BEST	5.1 mm	50	1833100000
BEST/DRBR	5.1 mm	50	1878570000
BEST/D	5.1 mm	50	1878560000
TNST		50	1833090000

DEK 5/5 / WS 14/5
If the disconnect lever is replaced by the SIHA 2, a fused terminal is created.

ZTR 6-2

6 mm²

2 connections

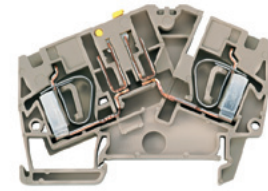

8.1 x 70 x 51
30 / 10
0.05...10

IEC	UL	CSA
500		
30		
6		
6 kV / 3		
A5 / V-0		
Rated connection		
0.5...10 / 0.5...6		
0.5...6 / 0.5...6		
12 / 0.6 x 3.5 mm		

Type	Qty.	Order No.
ZTR 6-2	50	1023830000

Type	current	Qty.	Order No.
ZQV 6/2 GE	41 A	60	1627850000
ZQV 6/3 GE	41 A	60	1627860000
ZQV 6/4 GE	41 A	60	1627870000
ZQV 6/24 GE	41 A	10	1908990000
Width			
ZAP ZDU6-2	2 mm	50	1771440000
ZEW 35			
	6 mm	20	9540000000
SDIS 0.6X3.5X100			
		1	9008390000

Roof-style

ZTR 6-2 E

6 mm²

Operation mode

In hazardous area applications, the installation instructions and the rated data specifications for accessories given in the technical appendix must be followed.

Width/Length/Height of lowest version	mm
max. current / max. cond. cross-section	A/mm ²
Max. clamping range	mm ²

Technical data

Rated data	
Rated voltage	V
Rated current	A
Rated cross-section	mm ²
Rated impulse withstand voltage / Pollution severity	
Gauge to IEC 60947-1 / Flammability class UL94	
Approvals	
Clamped conductors (H05V/H07V)	
Solid / stranded	mm ²
Flexible / Flexible with ferrule	mm ²
Stripping length / Blade size	mm/-
Note	

Ordering data

Version	
	Dark beige Wemid, 230 V UC
	Dark beige Wemid, 24 V DC
Note	

Accessories

End plate / Partition plate	
	Dark beige Wemid
End bracket	
	Dark beige Wemid
Test adapter	
	With assembly peg
Screwdriver	
	Standard

8.1 x 70 x 51
20 / 10
0.05...10

IEC	UL	CSA
230		
20		
6		
	8 kV / 3	
	A5 / V-0	

Rated connection	
0.5...10 / 0.5...6	
0.5...6 / 0.5...6	
12 / 0.6 x 3.5 mm	

Type	Qty.	Order No.
ZTR 6-2 E / 230V UC	10	8817930000
ZTR 6-2 E / 24V DC	10	8817920000

Type	Width	Qty.	Order No.
ZAP ZDU6-2	2 mm	50	1771440000
ZEW 35	6 mm	20	9540000000
ZTA 7/ZA	8.1 mm	25	1780670000
SDIS 0.6X3.5X100		1	9008390000



Operating mode

ZTR6-2 E

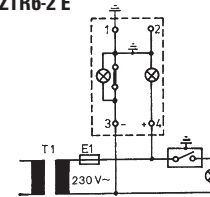

- Slide link is closed
- Auxiliary circuit is **earthed**
- Display is illuminated green

Test position

When measuring insulation resistance with voltages greater than U_{Nom}, the earth connection must first be disconnected.

ZTR6-2 E

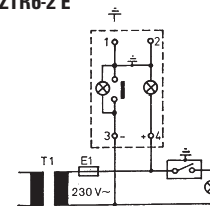

- Slide link is opened
- Auxiliary circuit is **not earthed**
- **No** earth fault
- Display illuminated green and red with reduced intensity
- Disconnected earth connection -> When measuring insulation resistance with voltages greater than U_{Nom}, the earth connection must be disconnected.

Operational malfunction

ZTR6-2 E

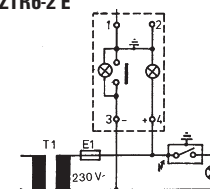

- Slide link is opened
- Auxiliary circuit is **not earthed**
- **Earth fault**
- Display is illuminated red

(see assortment in catalogue 7)

Note

Installation terminals

N-cross-connections with busbar system 10 x 3 mm.

In hazardous area applications, the installation instructions and the rated data specifications for accessories given in the technical appendix must be followed.

Width/Length/Height of lowest version	mm
max. current / max. cond. cross-section	A/mm ²
Max. clamping range	mm ²

Technical data

Rated data	
Rated voltage	V
Rated current	A
Rated cross-section	mm ²
Rated impulse withstand voltage / Pollution severity Gauge to IEC 60947-1 / Flammability class UL94	
Approvals	
Clamped conductors (H05V/H07V)	
Solid / stranded	mm ²
Flexible / Flexible with ferrule	mm ²
Stripping length / Blade size	mm/-
Note	

Ordering data

Version	
	Dark beige Wemid
	Blue Wemid
Note	

Accessories

Pluggable cross-connection	
	2-pole
	3-pole
	4-pole
	10-pole
	20-/24-pole
End plate / Partition plate	
	Dark beige Wemid
	Blue Wemid
Support bracket for 10 x 3 (required every 20 cm)	
	Blue Wemid
	For a vertical installation position
End bracket	
	Dark beige Wemid
Screwdriver	
	Standard

Identification systems	
	(see assortment in catalogue 7)
	Marking tags
Note	

ZDU 2.5 S

2.5 mm²

Two connections



5.1 x 61 x 44
24 / 4
0.5...4

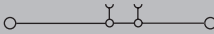

IEC 60947-7-1

IEC	UL	CSA
400		
24		
2.5		
	6 kV / 3	
	A2 / V-0	
Rated connection		
0.5...4		
0.5...4 / 0.5...2.5		
10 / 0.6 x 3.5 mm		
The supply to the busbar is via a busbar connection (ZB 35, ZB 16 or ZF 4S).		

Type	Qty.	Order No.
ZDU 2.5 S	100	1808010000
ZDU 2.5 S BL	100	1808020000
The distance from holding plate to holding plate should be 200 mm.		

Type	current	Qty.	Order No.
ZQV 2.5/2	24 A	60	1608860000
ZQV 2.5/3	24 A	60	1608870000
ZQV 2.5/4	24 A	60	1608880000
ZQV 2.5/10	24 A	20	1608940000
ZQV 2.5/20	24 A	20	1908960000
Width			
ZAP ZDU 2.5 S	2 mm	20	1808030000
ZAP ZDU 2.5 S BL	2 mm	20	1808040000
ZHP S	3 mm	20	1808290000
ZHP S SO	3 mm	20	1808280000
ZEW 35	6 mm	20	9540000000
SDIS SL 1.0X4.5X125		1	1274680000

DEK 5/5 / WS 10/5

ZDU 4 S

4 mm²

Two connections



6.1 x 64.2 x 46
32 / 6
0.5...6

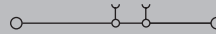

IEC 60947-7-1

IEC	UL	CSA
400		
32		
4		
	6 kV / 3	
	A3 / V-0	
Rated connection		
0.5...6		
0.5...4 / 0.5...4		
10 / 0.6 x 3.5 mm		
The supply to the busbar is via a busbar connection (ZB 35, ZB 16 or ZF 4S).		

Type	Qty.	Order No.
ZDU 4 S	100	1808360000
ZDU 4 S BL	100	1808370000
The distance from holding plate to holding plate should be 200 mm.		

Type	current	Qty.	Order No.
ZQV 4/2 GE	32 A	60	1608950000
ZQV 4/3 GE	32 A	60	1608960000
ZQV 4/4 GE	32 A	60	1608970000
ZQV 4/10 GE	32 A	20	1609030000
ZQV 4/20 GE	32 A	20	1909010000
Width			
ZAP ZDU 4 S	2 mm	20	1808380000
ZAP ZDU 4 S BL	2 mm	20	1808390000
ZHP S	3 mm	20	1808290000
ZHP S SO	3 mm	20	1808280000
ZEW 35	6 mm	20	9540000000
SDIS SL 0.6X3.5X100		1	1274660000

DEK 5/5 / WS 10/6

ZDU 6S **6 mm²**

Two connections

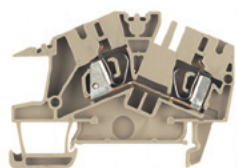

8.1 x 64.35 x 50.09
41 / 10
0.5...10

IEC 60947-7-1

IEC	UL	CSA
400		
41		
6		
6 kV / 3		
A5 / V-0		



Rated connection

0.5...10
 0.5...10 / 0.5...6
 12 / 0.6 x 3.5 mm

The supply to the busbar is via a busbar connection (ZB 35, ZB 16 or ZF 4S).

Type	Qty.	Order No.
ZDU 6 S	100	1808230000
ZDU 6 S BL	100	1808240000

The distance from holding plate to holding plate should be 200 mm.

Type	current	Qty.	Order No.
ZQV 6/2 GE	41 A	60	1627850000
ZQV 6/3 GE	41 A	60	1627860000
ZQV 6/4 GE	41 A	60	1627870000
ZQV 6/24 GE	41 A	10	1908990000
Width			
ZAP ZDU 6 S	2 mm	20	1808250000
ZAP ZDU 6 S BL	2 mm	20	1808260000
ZHP S	3 mm	20	1808290000
ZHP S SO	3 mm	20	1808280000
ZEW 35	6 mm	20	9540000000
SDIS SL 0.8X4.0X100		1	1274670000

DEK 5/8 / WS 10/6

ZDU 10/S **10 mm²**

Two connections



10 x 86.5 x 48.5
76 / 16
1.3...16

IEC 60947-7-1

IEC	UL	CSA
400	600 (C)	300 (C)
57	60 (C)	55 (C)
10	AWG 16...6	AWG 16...6
6 kV / 3		
A6 / V-0		



Rated connection

1.5...16 / 1.5...16
 1.5...10 / 1.5...10
 18 / 1.0 x 5.5 mm

The supply to the busbar is via a busbar connection (ZB 35, ZB 16 or ZF 4S).

Type	Qty.	Order No.
ZDU 10S	25	1739540000
ZDU 10S BL	25	1739550000

The distance from holding plate to holding plate should be 200 mm.

Type	current	Qty.	Order No.
ZQV 10/2	17.5 A	25	1739680000
Width			
ZAP ZDU10/16S	2 mm	20	1739660000
ZEW 35	6 mm	20	9540000000
SDIS SL 1.0X4.5X125		1	1274680000

DEK 5/5

ZDU 16/S **16 mm²**

Two connections



12 x 95 x 48.5
76 / 25
1.5...25

IEC 60947-7-1

IEC	UL	CSA
400	600 (C)	300 (C)
76	65 (C)	65 (C)
16	AWG 14...4	AWG 14...4
6 kV / 3		
A7 / V-0		



Rated connection

1.5...16 / 1.5...25
 1.5...16 / 1.5...16
 18 / 1.0 x 5.5 mm

The supply to the busbar is via a busbar connection (ZB 35, ZB 16 or ZF 4S).

Type	Qty.	Order No.
ZDU 16S	25	1739580000
ZDU 16S BL	25	1739590000

The distance from holding plate to holding plate should be 200 mm.

Type	current	Qty.	Order No.
ZQV 16/2	76 A	25	1739690000
Width			
ZAP ZDU10/16S	2 mm	20	1739660000
ZEW 35	6 mm	20	9540000000
SDIS SL 1.0X4.5X125		1	1274680000

DEK 5/5

Installation terminals

N-cross-connections with busbar system 10 x 3 mm.

In hazardous area applications, the installation instructions and the rated data specifications for accessories given in the technical appendix must be followed.

Width/Length/Height of lowest version	mm
max. current / max. cond. cross-section	A/mm ²
Max. clamping range	mm ²







Technical data

Rated data	
Rated voltage	V
Rated current	A
Rated cross-section	mm ²
Rated impulse withstand voltage / Pollution severity Gauge to IEC 60947-1 / Flammability class UL94	
Approvals	
Clamped conductors (H05V/H07V)	
Solid / stranded	mm ²
Flexible / Flexible with ferrule	mm ²
Stripping length / Blade size	mm/-
Note	

Ordering data

Version	
	Dark beige Wemid
	Blue Wemid
Note	

Accessories

Pluggable cross-connection	
	2-pole
	3-pole
	4-pole
	20-/24-pole
End plate / Partition plate	
	Dark beige Wemid
	Blue Wemid
Support bracket for 10 x 3 (required every 20 cm)	
	Blue Wemid For a vertical installation position
End bracket	
	Dark beige Wemid
Screwdriver	
	Standard
Busbar 10 x 3 (140 A)	
	OK, Busbar up to OK, TS35 = 25.5 mm
Clamping yoke for power supply to 10 x 3 busbars	
	Rigid / flexible 0.5 - 6 / 4 mm ²
	Rigid / flexible 6 - 16 mm ²
	Flexible 16 - 35 mm ²
Identification systems (see assortment in catalogue 7)	
	Marking tags
Note	

ZNT 6 S

6 mm²

Two connections

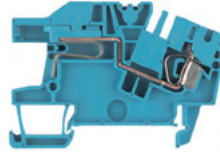

8.1 x 64.35 x 50.09
41 / 10
0.5...10

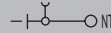

IEC 60947-7-1

IEC	UL	CSA
250		
41		
6		
	4 kV / 3	
	A5 / V-0	
Rated connection		
0.5...10		
0.5...10 / 0.5...6		
12 / 0.6 x 3.5 mm		
The supply to the busbar is via a busbar connection (ZB 35, ZB 16 or ZF 4S).		

Type	Qty.	Order No.
ZNT 6 S	50	1808320000
The distance from holding plate to holding plate should be 200 mm.		

Type	current	Qty.	Order No.
ZQV 6/2 GE	41 A	60	1627850000
ZQV 6/3 GE	41 A	60	1627860000
ZQV 6/4 GE	41 A	60	1627870000
ZQV 6/24 GE	41 A	10	1908990000
Width			
ZAP ZDU 6 S	2 mm	20	1808250000
ZAP ZDU 6 S BL	2 mm	20	1808260000
ZHP S	3 mm	20	1808290000
ZHP S SO	3 mm	20	1808280000
ZEW 35	6 mm	20	9540000000
SDIS SL 0.8X4.0X100		1	1274670000
SSCH 10X3X1000 CU/SN	10 mm	1	0348900000
ZB 4K BL	6 mm	50	0475380000
ZB 16K BL	10 mm	50	0502880000
ZB 35K BL M6X16	14 mm	20	0502680000

DEK 5/8 / WS 10/6

ZNT 10 S

10 mm²

Two connections

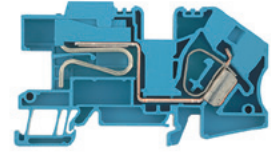

10 x 86.5 x 50
/ 16
1.3...16



IEC 60947-7-1

IEC	UL	CSA
400	600 (C)	300 (C)
57	55 (C)	55 (C)
10	AWG 16...6	AWG 16...6
	6 kV / 3	
	A6 / V-0	
Rated connection		
1.5...16 / 1.5...16		
1.5...10 / 1.5...10		
18 / 1.0 x 5.5 mm		
The supply to the busbar is via a busbar connection (ZB 35, ZB 16 or ZF 4S).		

Type	Qty.	Order No.
ZNT 10S	25	1739560000
The distance from holding plate to holding plate should be 200 mm.		

Type	current	Qty.	Order No.
ZQV 16/2	76 A	25	1739690000
Width			
ZAP ZDU10/16S	2 mm	20	1739660000
ZEW 35	6 mm	20	9540000000
SDIS SL 1.0X4.5X125		1	1274680000
SSCH 10X3X1000 CU/SN	10 mm	1	0348900000
ZB 4K BL	6 mm	50	0475380000
ZB 16K BL	10 mm	50	0502880000
ZB 35K BL M6X16	14 mm	20	0502680000

DEK 5/5

ZNT 16/S

16 mm²

Two connections

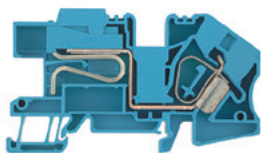

12 x 95 x 50
76 / 25
1.5...25

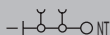

IEC 60947-7-1

IEC	UL	CSA
400	600 (C)	300 (C)
76	58 (C)	65 (C)
16	AWG 14...4	AWG 14...4
6 kV / 3		
A7 / V-0		



Rated connection

1.5...16 / 16...25
1.5...16 / 1.5...16
18 / 1.0 x 5.5 mm

The supply to the busbar is via a busbar connection (ZB 35, ZB 16 or ZF 4S).

Type	Qty.	Order No.
ZNT 16S	25	1739600000

The distance from holding plate to holding plate should be 200 mm.

Type	current	Qty.	Order No.
ZQV 16/2	76 A	25	1739690000
Width			
ZAP ZDU10/16S	2 mm	20	1739660000
Width			
ZEW 35	6 mm	20	9540000000
SDIS SL 1.0X4.5X125		1	1274680000
SSCH 10X3X1000 CU/SN	10 mm	1	0348900000
ZB 4K BL	6 mm	50	0475380000
ZB 16K BL	10 mm	50	0502880000
ZB 35/M6X16	14 mm	20	0266500000

DEK 5/5

ZNT 35

35 mm²

Two connections

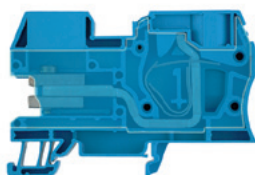

16 x 88.5 x 59
125 / 35
2.5...35



IEC 60947-7-1

IEC	UL	CSA
400	600 (C)	600 (C)
125	120 (C)	120 (C)
35	AWG 12...2	AWG 12...2
6 kV / 3		
A8 / V-0		



Rated connection

2.5...10 / 16...35
2.5...35 / 2.5...35
25 / 1.0 x 5.5 mm

The supply to the busbar is via a busbar connection (ZB 35, ZB 16 or ZF 4S).

Type	Qty.	Order No.
ZNT 35	10	1739640000

The distance from holding plate to holding plate should be 200 mm.

Type	current	Qty.	Order No.
ZEW 35	6 mm	20	9540000000
SDIS SL 1.0X4.5X125		1	1274680000
SSCH 10X3X1000 CU/SN	10 mm	1	0348900000
Width			
ZB 4K BL	6 mm	50	0475380000
ZB 16K BL	10 mm	50	0502880000
ZB 35K BL M6X16	14 mm	20	0502680000

DEK 5/5

Integrated end plate.

Installation terminals

N-cross-connections with busbar system 10 x 3 mm.

In hazardous area applications, the installation instructions and the rated data specifications for accessories given in the technical appendix must be followed.

Width/Length/Height of lowest version	mm
max. current / max. cond. cross-section	A/mm ²
Max. clamping range	mm ²



Technical data

Rated data	
Rated voltage	V
Rated current	A
Rated cross-section	mm ²
Rated impulse withstand voltage / Pollution severity	
Gauge to IEC 60947-1 / Flammability class UL94	
Approvals	
Clamped conductors (H05V/H07V)	
Solid / stranded	mm ²
Flexible / Flexible with ferrule	mm ²
Stripping length / Blade size	mm/-
Note	

Ordering data

Version	
	Dark beige Wemid
	Blue Wemid
Note	

Accessories

Pluggable cross-connection	
	2-pole 3-pole 4-pole 20-/24-pole
End plate / Partition plate	
	Dark beige Wemid Blue Wemid
Support bracket for 10 x 3 (required every 20 cm)	
	Blue Wemid For a vertical installation position
End bracket	
	Dark beige Wemid
Screwdriver	
	Standard
Busbar 10 x 3 (140 A)	
	OK, Busbar up to OK, TS35 = 25.5 mm
Clamping yoke for power supply to 10 x 3 busbars	
	Rigid / flexible 0.5 - 6 / 4 mm ² Rigid / flexible 6 - 16 mm ² Flexible 16 - 35 mm ²
Identification systems (see assortment in catalogue 7)	
	Marking tags
Note	

ZDU 4 NT

4 mm²

Modified busbar position

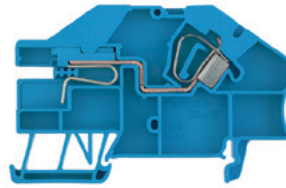

6.1 x 78.5 x 50.5
32 / 6
0.13...6



IEC 60947-7-1

IEC	UL	CSA
250		
32		
4		
	4 kV / 3	
	A4 / V-0	
Rated connection		
0.5...6		
0.5...4 / 0.5...4		
12 / 0.6 x 3.5 mm		
The supply to the busbar is via a busbar connection (ZB 35, ZB 16 or ZF 4S).		

Type	Qty.	Order No.
ZDU 4/NT DB	50	1778080000
ZDU 4/NT	50	1757980000
Use only in connection with ZDU 2.5, ZDU 2.5/3 AN, ZDU 4, ZDU 6 and their PE variants.		

Type	current	Qty.	Order No.
ZAP ZDU4/NT	1.5 mm	20	1757970000
ZHP ZDU4/NT S0	3 mm	20	1803890000
ZEW 35	6 mm	20	9540000000
SDIS SL 0.6X3.5X100		1	1274660000
SSCH 10X3X1000 CU/SN	10 mm	1	0348900000
ZB 4K BL	6 mm	50	0475380000
ZB 16K BL	10 mm	50	0502880000
ZB 35K BL M6X16	14 mm	20	0502680000

DEK 5/5 / WS 15/5

ZDU 10 NT

10 mm²

Modified busbar position

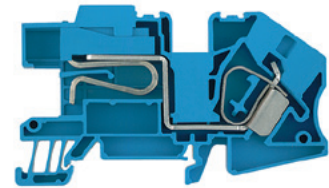

10 x 86.5 x 50
57 / 16
1.5...16

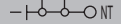

IEC 60947-7-1

IEC	UL	CSA
250		
57		
10		
	4 kV / 3	
	A6 / V-0	
Rated connection		
1.5...10 / 1.5...16		
1.5...10 / 1.5...10		
18 / 1.0 x 5.5 mm		
The supply to the busbar is via a busbar connection (ZB 35, ZB 16 or ZF 4S).		

Type	Qty.	Order No.
ZDU 10/NT	25	1762420000
Use only in connection with ZDU 2.5, ZDU 2.5/3 AN, ZDU 4, ZDU 6 and their PE variants.		

Type	current	Qty.	Order No.
ZDV 10/2	17.5 A	25	1739680000
ZAP ZDU10/16S	2 mm	20	1739660000
ZHP ZDU4/NT S0	3 mm	20	1803890000
ZEW 35	6 mm	20	9540000000
SDIS SL 1.0X4.5X125		1	1274680000
SSCH 10X3X1000 CU/SN	10 mm	1	0348900000
ZB 4K BL	6 mm	50	0475380000
ZB 16K BL	10 mm	50	0502880000
ZB 35K BL M6X16	14 mm	20	0502680000

WS 12/5 / DEK 5/6

N-cross-connections with busbar system 10 x 3 mm.

In hazardous area applications, the installation instructions and the rated data specifications for accessories given in the technical appendix must be followed.

Width/Length/Height of lowest version	mm
max. current / max. cond. cross-section	A/mm ²
Max. clamping range	mm ²

Technical data

Rated data	
Rated voltage	V
Rated cross-section	mm ²
Rated impulse withstand voltage / Pollution severity	
Gauge to IEC 60947-1 / Flammability class UL94	
Approvals	
Clamped conductors (H05V/H07V)	
Solid / stranded	mm ²
Flexible / Flexible with ferrule	mm ²
Stripping length / Blade size	mm/-
Note	

Ordering data

Version	green/yellow Wemid
Note	

Accessories

End plate / Partition plate	Dark beige Wemid
Support bracket for 10 x 3 (required every 20 cm)	Blue Wemid For a vertical installation position
End bracket	Dark beige Wemid
Screwdriver	Standard

Identification systems	(see assortment in catalogue 7) Marking tags
Note	

ZPE 2.5 S

2.5 mm²

Two connections



5.1 x 62.5 x 44	
/ 4	
0.5...4	

IEC 60947-7-2

IEC	UL	CSA
400		
2.5		
	6 kV / 3	
	A2 / V-0	
Rated connection		
0.5...4		
0.5...4 / 0.5...2.5		
10 / 0.6 x 3.5 mm		
The supply to the busbar is via a busbar connection (ZB 35, ZB 16 or ZF 4S).		

Type	Qty.	Order No.
ZPE 2.5 S	100	1808330000
The distance from holding plate to holding plate should be 200 mm.		

Type	Width	Qty.	Order No.
ZAP ZDU 2.5 S	2 mm	20	1808030000
ZHP S	3 mm	20	1808290000
ZHP S SO	3 mm	20	1808280000
ZEW 35	6 mm	20	9540000000
SDIS SL 0.6X3.5X100		1	1274660000

DEK 5/5 / WS 10/5

ZPE 4 S

4 mm²

Two connections



6.1 x 65.5 x 46	
/ 6	
0.5...6	

IEC 60947-7-2

IEC	UL	CSA
400		
4		
	6 kV / 3	
	A3 / V-0	
Rated connection		
0.5...6		
0.5...4 / 0.5...4		
10 / 0.6 x 3.5 mm		
The supply to the busbar is via a busbar connection (ZB 35, ZB 16 or ZF 4S).		

Type	Qty.	Order No.
ZPE 4 S	100	1808340000
The distance from holding plate to holding plate should be 200 mm.		

Type	Width	Qty.	Order No.
ZAP ZDU 4 S	2 mm	20	1808380000
ZHP S	3 mm	20	1808290000
ZHP S SO	3 mm	20	1808280000
ZEW 35	6 mm	20	9540000000
SDIS SL 0.6X3.5X100		1	1274660000

DEK 5/6 / WS 10/6

Installation terminals

N-cross-connections with busbar system 10 x 3 mm.

In hazardous area applications, the installation instructions and the rated data specifications for accessories given in the technical appendix must be followed.

Width/Length/Height of lowest version	mm
max. current / max. cond. cross-section	A/mm ²
Max. clamping range	mm ²

Technical data

Rated data	
Rated voltage	V
Rated cross-section	mm ²
Rated impulse withstand voltage / Pollution severity	
Gauge to IEC 60947-1 / Flammability class UL94	
Approvals	
Clamped conductors (H05V/H07V)	
Solid / stranded	mm ²
Flexible / Flexible with ferrule	mm ²
Stripping length / Blade size	mm/-
Note	

Ordering data

Version	
	green/yellow Wemid
Note	

Accessories

End plate / Partition plate	Dark beige Wemid
Support bracket for 10 x 3 (required every 20 cm)	Blue Wemid For a vertical installation position
End bracket	Dark beige Wemid
Screwdriver	Standard

Identification systems	(see assortment in catalogue 7)
	Marking tags
Note	

ZPE 6 S

6 mm²

Two connections



8.1 x 65.5 x 50.09	
/ 10	
0.5...10	

IEC 60947-7-2

IEC	UL	CSA
400		
6		
	6 kV / 3	
	A5 / V-0	
Rated connection		
0.5...10		
0.5...10 / 0.5...6		
12 / 0.6 x 3.5 mm		
The supply to the busbar is via a busbar connection (ZB 35, ZB 16 or ZF 4S).		

Type	Qty.	Order No.
ZPE 6 S	100	1808350000
The distance from holding plate to holding plate should be 200 mm.		

Type	Width	Qty.	Order No.
ZAP ZDU 6 S	2 mm	20	1808250000
ZHP S	3 mm	20	1808290000
ZHP S SO	3 mm	20	1808280000
ZEW 35	6 mm	20	9540000000
SDIS SL 0.6X3.5X100		1	1274660000

DEK 5/8 / WS 10/6	
Note	

ZPE 10/S

10 mm²

Two connections



10 x 86.5 x 48.5	
/ 16	
1.3...16	

IEC 60947-7-2

IEC	UL	CSA
400		
10	AWG 16...6	AWG 16...6
	6 kV / 3	
	A6 / V-0	
Rated connection		
1.5...16 / 1.5...16		
1.5...10 / 1.5...10		
18 / 1.0 x 5.5 mm		
The supply to the busbar is via a busbar connection (ZB 35, ZB 16 or ZF 4S).		

Type	Qty.	Order No.
ZPE 10S	25	1739570000
The distance from holding plate to holding plate should be 200 mm.		

Type	Width	Qty.	Order No.
ZAP ZDU10/16S	2 mm	20	1739660000
ZEW 35	6 mm	20	9540000000
SDIS SL 1.0X4.5X125		1	1274680000

DEK 5/5 / WS 10/5	
Note	

ZPE 16/S

16 mm²

Two connections

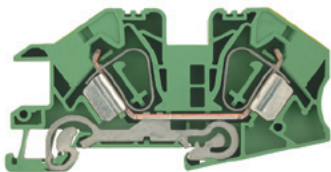

12 x 95 x 48.5
/ 25
1.5...25

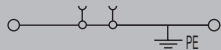

IEC 60947-7-2

IEC	UL	CSA
400		
16	AWG 14...4	AWG 14...4
	6 kV / 3	
	A7 / V-0	



Rated connection

1.5...16 / 16...25
1.5...16 / 1.5...16
18 / 1.0 x 5.5 mm

To ensure the current-carrying capacity of the mounting rail, it is necessary to use the TS 35 x 15.

Type	Qty.	Order No.
ZPE 16S	25	1739610000

The distance from holding plate to holding plate should be 200 mm.

Type	Width	Qty.	Order No.
ZAP ZDU10/16S	2 mm	20	1739660000
ZEW 35	6 mm	20	9540000000
SDIS SL 1.0X4.5X125		1	1274680000

DEK 5/5

WeiCoS pluggable terminal block system

Connecting prefabricated functional units with speed and versatility

Our pluggable terminal rails with tension-clamp connections enable you to change functional units in the electrical cabinet quickly and simply.

C

Modular and flexible connection systems are especially in demand where complete functional units have to be prefabricated or replaced. Here WeiCoS (Weidmüller Connection System) – pluggable terminal blocks – show their full strengths. Quickly mounted, fully factory testable functional units which are faster and easier to replace.

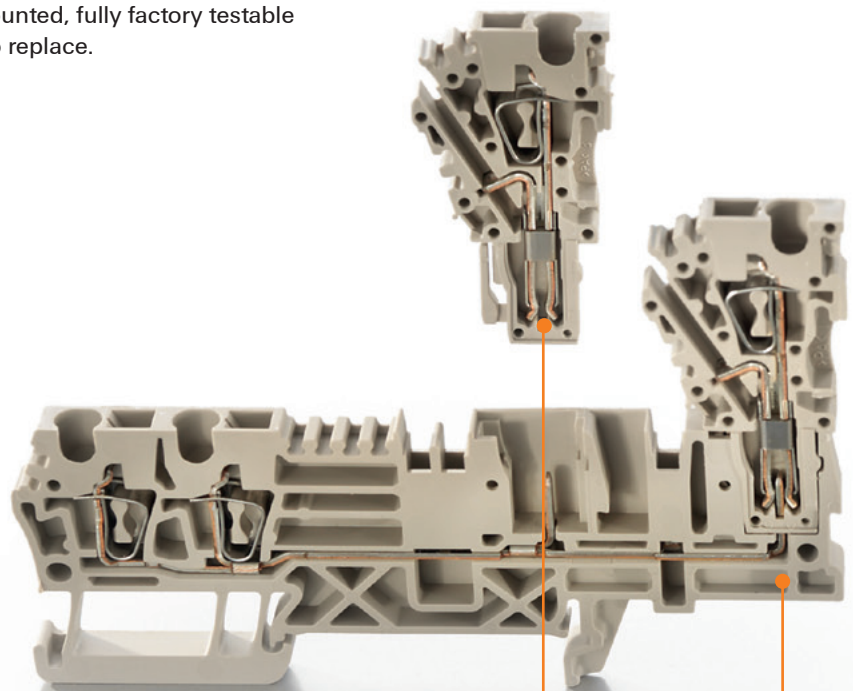

Reliable connection

Terminal rails and plugs have tension-clamp connections that separate the electrical and mechanical functions from each other. The steel tension clamps as well as the external plug contacts ensure optimum contact forces; the copper busbars, lower voltage drops.



Solid interlock

All the connectors can be locked securely to the base terminals using locking elements.

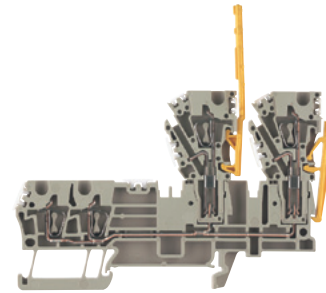

Power supply

Power is supplied using standard Z-series terminal blocks or with power supply terminals.

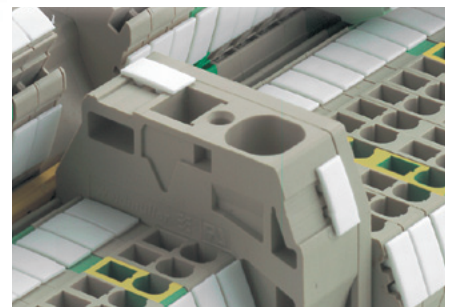

Simple operation

The parallel direction of wire entries and screwdriver operating direction means that you have a practical connection with the TOP connection system for which no special tools are needed. Test points are integrated.

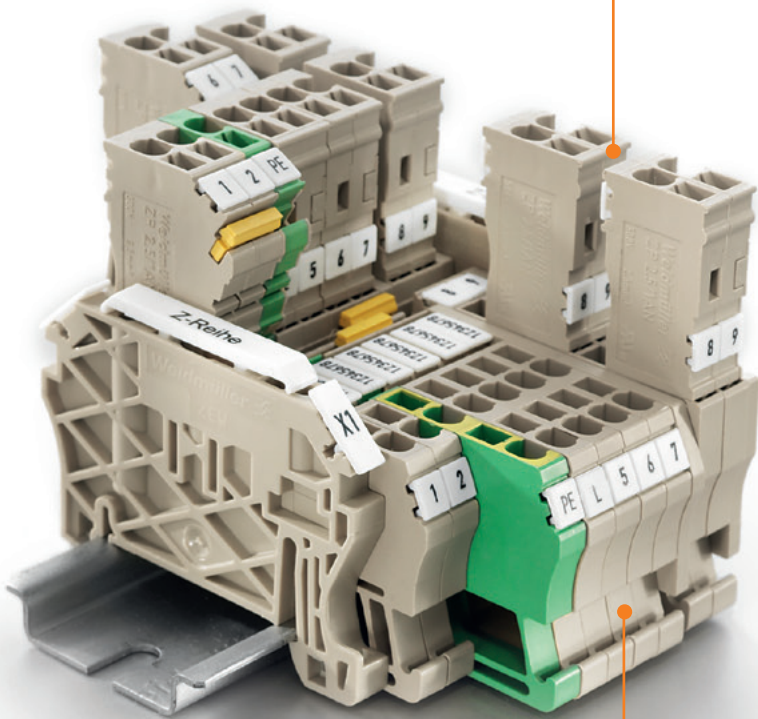
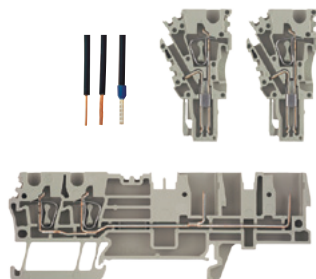

Pluggable standard terminals WeiCoS

Feed-through terminals

WeiCoS - Pluggable terminal blocks for wire cross-sections from 0.13 to 4 mm².

In hazardous area applications, the installation instructions and the rated data specifications for accessories given in the technical appendix must be followed.

Width/Length/Height of lowest version	mm
max. current / max. cond. cross-section	A/mm ²
Max. clamping range	mm ²

Technical data

Rated data	
Rated voltage	V
Max. voltage of clamp support & pluggable system	V
Rated current	A
Rated cross-section	mm ²
Rated impulse withstand voltage / Pollution severity	
Gauge to IEC 60947-1 / Flammability class UL94	
Approvals	
Clamped conductors (H05V/H07V)	
Solid / stranded	mm ²
Flexible / Flexible with ferrule	mm ²
Stripping length / Blade size	mm/-
Note	

Ordering data

Base terminal	
	Dark beige Wemid
Plug-in connector	
	1-pole
	2-pole
	3-pole
	4-pole
	5-pole
	6-pole
	7-pole
	8-pole
	9-pole
	10-pole
Note	

Accessories

Pluggable cross-connection	
	2-pole
	3-pole
	4-pole
	10-pole
	20-/24-pole
End plate / Partition plate	
	Dark beige Wemid
	Orange Wemid
Test adapter	
	Standard
	With assembly peg
Miscellaneous accessories WeiCoS	
	Locking element
	Coding element
	Strain relief
Screwdriver	
	Standard
Identification systems	
	(see assortment in catalogue 7)
	Marking tags
Note	

ZT 2.5/2AN/1

2.5 mm²

1 tension clamp connection / 1 pluggable connection

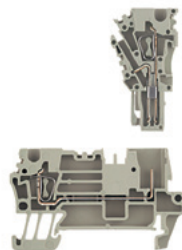

5.1 x 58 x 35
24 / 4
0.13...4

IEC 60947-7-1, IEC 61984

IEC	UL	CSA
500	300 (C)	300 (C)
690		
24	20 (C)	20 (C)
2.5	AWG 26...12	26...12
6 kV / 3		
A2 / V-0		
Rated connection		Plug-in connection
0.5...4		
0.5...4 / 0.5...2.5		0.5/ 0.5...
10 / 0.6 x 3.5 mm		
2.5 mm ² flexible wires with wire-end ferrules are crimped with the Weidmüller PZ 6/5 crimping tool. UL & CSA D = 600 V / 5 A.		

Type	Qty.	Order No.
ZT 2.5/2AN/1	50	1815070000
Type	Qty.	Order No.
ZP 2.5/1AN/QV/1	50	1815190000
ZP 2.5/1AN/QV/2	25	1815200000
ZP 2.5/1AN/QV/3	25	1815210000
ZP 2.5/1AN/QV/4	25	1815220000
ZP 2.5/1AN/QV/5	25	1815230000
ZP 2.5/1AN/QV/6	25	1815240000
ZP 2.5/1AN/QV/7	25	1815250000
ZP 2.5/1AN/QV/8	20	1815260000
ZP 2.5/1AN/QV/9	20	1815270000
ZP 2.5/1AN/QV/10	20	1815280000

Type	current	Qty.	Order No.
ZQV 2.5N/2 GE	24 A	60	1693800000
ZQV 2.5N/3 GE	24 A	60	1693810000
ZQV 2.5N/4 GE	24 A	60	1693820000
ZQV 2.5N/10 GE	24 A	20	1693880000
ZQV 2.5N/20 GE	24 A	20	1909000000
Width			
ZAP/TW ZT2.5/2AN	2.5 mm	50	1816030000
ZAP/TW ZT2.5/2AN OR	2.5 mm	50	1816040000
ZTA ZT2.5			
ZTA ZT2.5	5.1 mm	25	1827080000
ZTA ZT2.5/ZA	5.1 mm	25	1847600000
ZVR ZP2.5			
ZVR ZP2.5	3.9 mm	25	1816130000
KOSF ZT2.5			
KOSF ZT2.5	2.9 mm	50	1816150000
ZZE ZP2.5			
ZZE ZP2.5	9.9 mm	25	1816140000
SDIS SL 0.6X3.5X100		1	1274660000
DEK 5/6 / WS 10/5			
DEK 5/6 / WS 10/5			

ZT 2.5/3AN/1

2.5 mm²

2 tension clamp connections / 1 pluggable connection

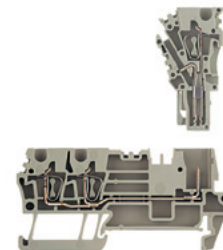

5.1 x 71.5 x 35
24 / 4
0.13...4

IEC 60947-7-1, IEC 61984

IEC	UL	CSA
500	300 (C)	300 (C)
690		
24	20 (C)	20 (C)
2.5	AWG 26...12	26...12
6 kV / 3		
A2 / V-0		
Rated connection		Plug-in connection
0.5...4		
0.5...4 / 0.5...2.5		0.5/ 0.5...
10 / 0.6 x 3.5 mm		
2.5 mm ² flexible wires with wire-end ferrules are crimped with the Weidmüller PZ 6/5 crimping tool. UL & CSA D = 600 V / 5 A.		

Type	Qty.	Order No.
ZT 2.5/3AN/1	50	1815090000
Type	Qty.	Order No.
ZP 2.5/1AN/QV/1	50	1815190000
ZP 2.5/1AN/QV/2	25	1815200000
ZP 2.5/1AN/QV/3	25	1815210000
ZP 2.5/1AN/QV/4	25	1815220000
ZP 2.5/1AN/QV/5	25	1815230000
ZP 2.5/1AN/QV/6	25	1815240000
ZP 2.5/1AN/QV/7	25	1815250000
ZP 2.5/1AN/QV/8	20	1815260000
ZP 2.5/1AN/QV/9	20	1815270000
ZP 2.5/1AN/QV/10	20	1815280000

Type	current	Qty.	Order No.
ZQV 2.5N/2 GE	24 A	60	1693800000
ZQV 2.5N/3 GE	24 A	60	1693810000
ZQV 2.5N/4 GE	24 A	60	1693820000
ZQV 2.5N/10 GE	24 A	20	1693880000
ZQV 2.5N/20 GE	24 A	20	1909000000
Width			
ZAP/TW ZT2.5/3AN	2.5 mm	50	1816050000
ZAP/TW ZT2.5/3AN OR	2.5 mm	50	1816060000
ZTA ZT2.5			
ZTA ZT2.5	5.1 mm	25	1827080000
ZTA ZT2.5/ZA	5.1 mm	25	1847600000
ZVR ZP2.5			
ZVR ZP2.5	3.9 mm	25	1816130000
KOSF ZT2.5			
KOSF ZT2.5	2.9 mm	50	1816150000
ZZE ZP2.5			
ZZE ZP2.5	9.9 mm	25	1816140000
SDIS SL 0.6X3.5X100		1	1274660000
DEK 5/5 / WS 10/5			
DEK 5/5 / WS 10/5			

ZT 2.5/4AN/2

2.5 mm²

2 tension clamp connections / 2 pluggable connections

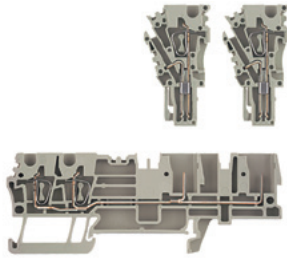

5.1 x 93 x 35
24 / 4
0.13...4

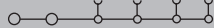

IEC 60947-7-1, IEC 61984

IEC	UL	CSA
500	300 (C)	300 (C)
690		
24	20 (C)	20 (C)
2.5	AWG 26...12	26...12
6 kV / 3		
A2 / V-0		

Rated connection	Plug-in connection
0.5...4	
0.5...4 / 0.5...2.5	0.5/ 0.5...
10 / 0.6 x 3.5 mm	

2.5 mm² flexible wires with wire-end ferrules are crimped with the Weidmüller PZ 6/5 crimping tool. UL & CSA D = 600 V / 5 A.

Type	Qty.	Order No.
ZT 2.5/4AN/2	50	1815110000
Type	Qty.	Order No.
ZP 2.5/1AN/QV/1	50	1815190000
ZP 2.5/1AN/QV/2	25	1815200000
ZP 2.5/1AN/QV/3	25	1815210000
ZP 2.5/1AN/QV/4	25	1815220000
ZP 2.5/1AN/QV/5	25	1815230000
ZP 2.5/1AN/QV/6	25	1815240000
ZP 2.5/1AN/QV/7	25	1815250000
ZP 2.5/1AN/QV/8	20	1815260000
ZP 2.5/1AN/QV/9	20	1815270000
ZP 2.5/1AN/QV/10	20	1815280000

Type	current	Qty.	Order No.
ZQV 2.5N/2 GE	24 A	60	1693800000
ZQV 2.5N/3 GE	24 A	60	1693810000
ZQV 2.5N/4 GE	24 A	60	1693820000
ZQV 2.5N/10 GE	24 A	20	1693880000
ZQV 2.5N/20 GE	24 A	20	1909000000
Width			
ZAP/TW ZT2.5/4AN/2	2.5 mm	50	1816070000
ZAP/TW ZT2.5/4AN/2 OR	2.5 mm	50	1816080000
ZTA ZT2.5	5.1 mm	25	1827080000
ZTA ZT2.5/ZA	5.1 mm	25	1847600000
ZVR ZP2.5	3.9 mm	25	1816130000
KOSF ZT2.5	2.9 mm	50	1816150000
ZZE ZP2.5	9.9 mm	25	1816140000
SDIS SL 0.6X3.5X100		1	1274660000

DEK 5/5 / WS 10/5

ZT 2.5/4AN/4

2.5 mm²

4 pluggable connections

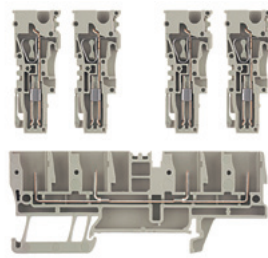

5.1 x 85.5 x 35
24 /
...

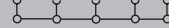

IEC 60947-7-1, IEC 61984

IEC	UL	CSA
500	300 (C)	300 (C)
690		
24	20 (C)	20 (C)
2.5	AWG 26...12	26...12
6 kV / 3		
/ V-0		

Rated connection	Plug-in connection
0.5...4	
0.5...4 / 0.5...2.5	0.5/ 0.5...
/ 0.6 x 3.5 mm	

2.5 mm² flexible wires with wire-end ferrules are crimped with the Weidmüller PZ 6/5 crimping tool. UL & CSA D = 600 V / 5 A.

Type	Qty.	Order No.
ZT 2.5/4AN/4	50	1815130000
Type	Qty.	Order No.
ZP 2.5/1AN/1	50	1815430000
ZP 2.5/1AN/2	25	1815440000
ZP 2.5/1AN/3	25	1815450000
ZP 2.5/1AN/4	25	1815500000
ZP 2.5/1AN/5	25	1815510000
ZP 2.5/1AN/6	25	1815520000
ZP 2.5/1AN/7	25	1815530000
ZP 2.5/1AN/8	20	1815540000
ZP 2.5/1AN/9	20	1815550000
ZP 2.5/1AN/10	20	1815560000

Type	current	Qty.	Order No.
ZQV 2.5N/2 GE	24 A	60	1693800000
ZQV 2.5N/3 GE	24 A	60	1693810000
ZQV 2.5N/4 GE	24 A	60	1693820000
ZQV 2.5N/10 GE	24 A	20	1693880000
ZQV 2.5N/20 GE	24 A	20	1909000000
Width			
ZAP/TW ZT2.5/4AN/4	2.5 mm	50	1816090000
ZTA ZT2.5	5.1 mm	25	1827080000
ZTA ZT2.5/ZA	5.1 mm	25	1847600000
ZVR ZP2.5	3.9 mm	25	1816130000
KOSF ZT2.5	2.9 mm	50	1816150000
ZZE ZP2.5	9.9 mm	25	1816140000
SDIS SL 0.6X3.5X100		1	1274660000

DEK 5/5 / WS 10/5

ZT 2.5/2x2AN

2.5 mm²

2 x 2 connections

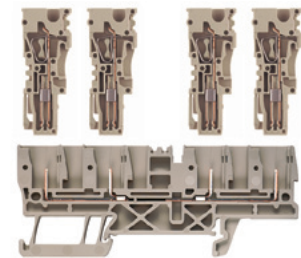

5.1 x 85.5 x 35
24 /
...

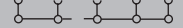

IEC 60947-7-1, IEC 61984

IEC	UL	CSA
500		
690		
24		
2.5		
6 kV / 3		
/ V-0		

Rated connection	Plug-in connection
0.5...4	
0.5...4 / 0.5...2.5	0.5/ 0.5...
/ 0.6 x 3.5 mm	

2.5 mm² flexible wires with wire-end ferrules are crimped with the Weidmüller PZ 6/5 crimping tool. UL & CSA D = 600 V / 5 A.

Type	Qty.	Order No.
ZT 2.5/2X2AN	50	1967200000
Type	Qty.	Order No.
ZP 2.5/1AN/1	50	1815430000
ZP 2.5/1AN/2	25	1815440000
ZP 2.5/1AN/3	25	1815450000
ZP 2.5/1AN/4	25	1815500000
ZP 2.5/1AN/5	25	1815510000
ZP 2.5/1AN/6	25	1815520000
ZP 2.5/1AN/7	25	1815530000
ZP 2.5/1AN/8	20	1815540000
ZP 2.5/1AN/9	20	1815550000
ZP 2.5/1AN/10	20	1815560000

Type	current	Qty.	Order No.
ZQV 2.5N/2 GE	24 A	60	1693800000
ZQV 2.5N/3 GE	24 A	60	1693810000
ZQV 2.5N/4 GE	24 A	60	1693820000
ZQV 2.5N/10 GE	24 A	20	1693880000
ZQV 2.5N/20 GE	24 A	20	1909000000
Width			
ZAP/TW ZT2.5/4AN/4	2.5 mm	50	1816090000
ZTA ZT2.5	5.1 mm	25	1827080000
ZTA ZT2.5/ZA	5.1 mm	25	1847600000
ZVR ZP2.5	3.9 mm	25	1816130000
KOSF ZT2.5	2.9 mm	50	1816150000
ZZE ZP2.5	9.9 mm	25	1816140000
SDIS SL 0.6X3.5X100		1	1274660000

DEK 5/5 / WS 10/5

Pluggable standard terminals WeiCoS

Feed-through terminals

ZTC 2.5/4AN/4

2.5 mm²

4 pluggable connections

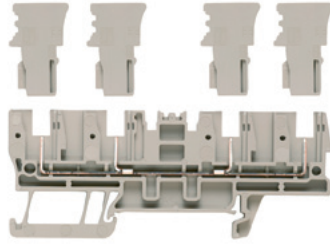

In hazardous area applications, the installation instructions and the rated data specifications for accessories given in the technical appendix must be followed.

Width/Length/Height of lowest version	mm
max. current / max. cond. cross-section	A/mm ²
Max. clamping range	mm ²

5.1 x 85.5 x 35	
/ 2.5	
0.5...2.5	

Technical data

Rated data	
Rated voltage	V
Max. voltage of clamp support & pluggable system	V
Rated current	A
Rated cross-section	mm ²
Rated impulse withstand voltage / Pollution severity	
Gauge to IEC 60947-1 / Flammability class UL94	
Approvals	
Clamped conductors (H05V/H07V)	
Solid / stranded	mm ²
Flexible / Flexible with ferrule	mm ²
Stripping length / Blade size	mm/-
Note	

IEC	UL	CSA
250		
24		
2.5		
	4 kV / 2	
	/ V-0	
Rated connection		Plug-in connection
0.5...2.5		/
Note		

Ordering data

Base terminal	
	Dark beige Wemid
Plug-in connector	
	1-pole
	2-pole
	3-pole
	4-pole
	5-pole
	6-pole
	7-pole
	8-pole
	9-pole
	10-pole
Note	

Type	Qty.	Order No.
ZTC 2.5/4AN/4	50	1898450000
Type	Qty.	Order No.
STGH ZPC2.5 DB	50	2321640000
Note		

Accessories

Pluggable cross-connection	
	2-pole
	3-pole
	4-pole
	10-pole
	20-/24-pole
End plate / Partition plate	
	Dark beige Wemid
	Orange Wemid
Test adapter	
	Standard
	With assembly peg
Miscellaneous accessories WeiCoS	
	Locking element
	Coding element
	Strain relief
Screwdriver	
	Standard
Identification systems (see assortment in catalogue 7)	
	Marking tags
Note	

Type	current	Qty.	Order No.
ZQV 2.5N/2 GE	24 A	60	1693800000
ZQV 2.5N/3 GE	24 A	60	1693810000
ZQV 2.5N/4 GE	24 A	60	1693820000
ZQV 2.5N/10 GE	24 A	20	1693880000
ZQV 2.5N/20 GE	24 A	20	1909000000
Width			
ZAP/TW ZT2.5/4AN/4	2.5 mm	50	1816090000
Note			
Note			
			DEK 5/5 / WS 10/5

Feed-through terminals

In hazardous area applications, the installation instructions and the rated data specifications for accessories given in the technical appendix must be followed.

Width/Length/Height of lowest version	mm
max. current / max. cond. cross-section	A/mm ²
Max. clamping range	mm ²

Technical data

Rated data	
Rated voltage	V
Max. voltage of clamp support & pluggable system	V
Rated current	A
Rated cross-section	mm ²
Rated impulse withstand voltage / Pollution severity	
Gauge to IEC 60947-1 / Flammability class UL94	
Approvals	
Clamped conductors (H05V/H07V)	
Solid / stranded	mm ²
Flexible / Flexible with ferrule	mm ²
Stripping length / Blade size	mm/-
Note	

Ordering data

Base terminal	
	Dark beige Wemid
Plug-in connector	
	1-pole
	2-pole
	3-pole
	4-pole
	5-pole
	6-pole
	7-pole
	8-pole
	9-pole
	10-pole
Note	

Accessories

Pluggable cross-connection	
	2-pole
	3-pole
	4-pole
	10-pole
	20-/24-pole
End plate / Partition plate	
	Dark beige Wemid
	Orange Wemid
Test adapter	
	Standard
	With assembly peg
Miscellaneous accessories WeiCoS	
	Locking element
	Coding element
	Strain relief
Screwdriver	
	Standard
Identification systems (see assortment in catalogue 7)	
	Marking tags
Note	

ZT 4/2AN/1

4 mm²

1 tension clamp connection / 1 pluggable connection

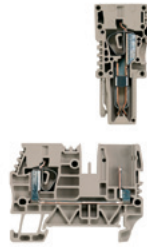

6.5 x 58 x 43.5
32 / 6
0.13...6

IEC 60947-7-1, IEC 61984

IEC	UL	CSA
800	600 (C)	600 (C)
800		
32	28 (C)	28 (C)
4	AWG 26...10	AWG 26...10
	8 kV / 3	
	A3 / V-0	
Rated connection		
0.5...6		
Plug-in connection		
0.5...6 / 0.5...4		
12 / 0.6 x 3.5 mm		
CSA current and voltage, acc. to Gr. C		

ZT 4/4AN/2

4 mm²

2 tension clamp connections / 2 pluggable connections

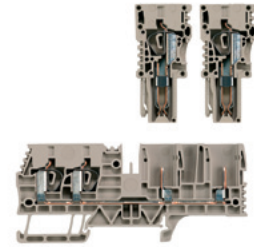

6.5 x 100.5 x 43.5
32 / 6
0.13...6

IEC 60947-7-1, IEC 61984

IEC	UL	CSA
800	600 (C)	600 (C)
800		
32	28 (C)	28 (C)
4	AWG 26...10	AWG 26...10
	8 kV / 3	
	A3 / V-0	
Rated connection		
0.5...6		
Plug-in connection		
0.5...6 / 0.5...4		
12 / 0.6 x 3.5 mm		
CSA current and voltage, acc. to Gr. C		

Type	Qty.	Order No.
ZT 4/2AN/1	50	1854960000
Type	Qty.	Order No.
ZP 4/1AN/1	50	1848340000
ZP 4/1AN/2	25	1854990000
ZP 4/1AN/3	25	1855000000
ZP 4/1AN/4	25	1855010000
ZP 4/1AN/5	20	1855020000
ZP 4/1AN/6	20	1855030000
ZP 4/1AN/7	20	1855040000
ZP 4/1AN/8	20	1855050000
ZP 4/1AN/9	10	1855060000
ZP 4/1AN/10	10	1855070000

Type	Qty.	Order No.
ZT 4/4AN/2	50	1848350000
Type	Qty.	Order No.
ZP 4/1AN/1	50	1848340000
ZP 4/1AN/2	25	1854990000
ZP 4/1AN/3	25	1855000000
ZP 4/1AN/4	25	1855010000
ZP 4/1AN/5	20	1855020000
ZP 4/1AN/6	20	1855030000
ZP 4/1AN/7	20	1855040000
ZP 4/1AN/8	20	1855050000
ZP 4/1AN/9	10	1855060000
ZP 4/1AN/10	10	1855070000

Type	current	Qty.	Order No.
ZQV 4/2 GE	32 A	60	1608950000
Width			
ZAP/TW ZT4/2AN	3.25 mm	50	1855220000
ZAP/TW ZT4/2AN OR	3.25 mm	50	1855230000
Width			
ZAP/TW ZT4/4AN/2 OR	3.25 mm	50	1855240000
Width			
ZVR ZP4	5.5 mm	25	1855250000
KOSF ZT4	5.4 mm	50	1856860000
ZZE ZP4	12.5 mm	25	1855260000
SDIS SL 0.6X3.5X100		1	1274660000
Width			
DEK 5/6 / WS 10/6			
Note			

Type	current	Qty.	Order No.
ZQV 4/2 GE	32 A	60	1608950000
Width			
ZAP/TW ZT4/4AN/2 OR	3.25 mm	50	1855240000
Width			
ZVR ZP4	5.5 mm	25	1855250000
KOSF ZT4	5.4 mm	50	1856860000
ZZE ZP4	12.5 mm	25	1855260000
SDIS SL 0.6X3.5X100		1	1274660000
Width			
DEK 5/6 / WS 10/6			
Note			

Pluggable standard terminals WeiCoS

Modular PE terminals

WeiCoS - Pluggable terminal blocks for wire cross-sections from 0.13 to 4 mm².

In hazardous area applications, the installation instructions and the rated data specifications for accessories given in the technical appendix must be followed.

Width/Length/Height of lowest version	mm
max. current / max. cond. cross-section	A/mm ²
Max. clamping range	mm ²

Technical data

Rated data	
Rated cross-section	mm ²
Max. voltage of clamp support & pluggable system	V
Rated voltage to adjoining terminal	V
Rated impulse withstand voltage to adjacent terminal	kV
Rated short-time current	
Pollution severity	
Gauge to IEC 60947-1 / Flammability class UL94	
Approvals	
Clamped conductors (H05V/H07V)	
Solid / stranded	mm ²
Flexible / Flexible with ferrule	mm ²
Stripping length / Blade size	mm/-
Note	

Ordering data

Base terminal	green/yellow Wemid
Plug-in connector	1-pole
Note	

Accessories

End plate / Partition plate	Dark beige Wemid Orange Wemid
Test adapter	Standard With assembly peg
Miscellaneous accessories WeiCoS	Locking element Coding element Strain relief
Screwdriver	Standard

Identification systems	(see assortment in catalogue 7) Marking tags
Note	

ZTPE 2.5/2AN/1

2.5 mm²

1 tension clamp connection / 1 pluggable connection

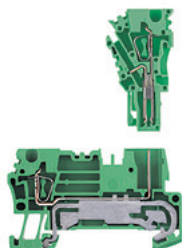

5.1 x 58 x 35
/ 4
0.13...4

IEC 60947-7-2

IEC	UL	CSA
2.5	AWG 26...12	26...12
690		
500		
6		
300 A (2.5 mm ²)		
3		
A2 / V-0		

Rated connection	Plug-in connection
0.5...4	
0.5...4 / 0.5...2.5	0.5/ 0.5...2.5
10 / 0.6 x 3.5 mm	
2.5 mm ² flexible wires with wire-end ferrules are crimped with the Weidmüller PZ 6/5 crimping tool. UL & CSA D = 600 V / 5 A	

Type	Qty.	Order No.
ZTPE 2.5/2AN/1	50	1815080000
Type	Qty.	Order No.
ZP 2.5/1AN/QV/1 GN	50	1820570000

Type	Width	Qty.	Order No.
ZAP/TW ZT2.5/2AN	2.5 mm	50	1816030000
ZAP/TW ZT2.5/2AN OR	2.5 mm	50	1816040000
ZTA ZT2.5	5.1 mm	25	1827080000
ZTA ZT2.5/ZA	5.1 mm	25	1847600000
ZVR ZP2.5	3.9 mm	25	1816130000
KOSF ZT2.5	2.9 mm	50	1816150000
ZZE ZP2.5	9.9 mm	25	1816140000
SDIS SL 0.6X3.5X100		1	1274660000

DEK 5/5 / WS 10/5	
Note	

ZTPE 2.5/3AN/1

2.5 mm²

2 tension clamp connections / 1 pluggable connection

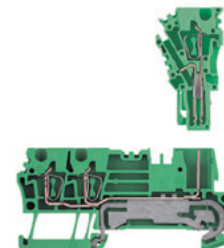

5.1 x 71.5 x 35
/ 4
0.13...4

IEC 60947-7-2

IEC	UL	CSA
2.5	AWG 26...12	26...12
690		
500		
6		
300 A (2.5 mm ²)		
3		
A2 / V-0		

Rated connection	Plug-in connection
0.5...4	
0.5...4 / 0.5...2.5	0.5/ 0.5...2.5
10 / 0.6 x 3.5 mm	
2.5 mm ² flexible wires with wire-end ferrules are crimped with the Weidmüller PZ 6/5 crimping tool. UL & CSA D = 600 V / 5 A	

Type	Qty.	Order No.
ZTPE 2.5/3AN/1	50	1815100000
Type	Qty.	Order No.
ZP 2.5/1AN/QV/1 GN	50	1820570000

Type	Width	Qty.	Order No.
ZAP/TW ZT2.5/3AN	2.5 mm	50	1816050000
ZAP/TW ZT2.5/3AN OR	2.5 mm	50	1816060000
ZTA ZT2.5	5.1 mm	25	1827080000
ZTA ZT2.5/ZA	5.1 mm	25	1847600000
ZVR ZP2.5	3.9 mm	25	1816130000
KOSF ZT2.5	2.9 mm	50	1816150000
ZZE ZP2.5	9.9 mm	25	1816140000
SDIS SL 0.6X3.5X100		1	1274660000

DEK 5/5 / WS 10/5	
Note	

ZTPE 2.5/4AN/2

2.5 mm²

2 tension clamp connections / 2 pluggable connections

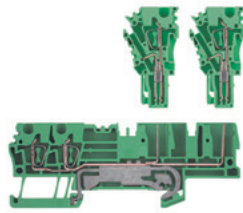

5.1 x 93 x 35
/ 4
0.13...4

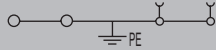

IEC 60947-7-2

IEC	UL	CSA
2.5	AWG 26...12	26...12
690		
500		
	6	
	300 A (2.5 mm ²)	
	3	
	A2 / V-0	

Rated connection	Plug-in connection
0.5...4	
0.5...4 / 0.5...2.5	0.5/ 0.5...2.5
10 / 0.6 x 3.5 mm	

2.5 mm² flexible wires with wire-end ferrules are crimped with the Weidmüller PZ 6/5 crimping tool. UL & CSA D = 600 V / 5 A

Type	Qty.	Order No.
ZTPE 2.5/4AN/2	50	1815120000
Type	Qty.	Order No.
ZP 2.5/1AN/QV/1 GN	50	1820570000

Type	Width	Qty.	Order No.
ZAP/TW ZT2.5/4AN/2	2.5 mm	50	1816070000
ZAP/TW ZT2.5/4AN/2 OR	2.5 mm	50	1816080000
ZTA ZT2.5	5.1 mm	25	1827080000
ZTA ZT2.5/ZA	5.1 mm	25	1847600000
ZVR ZP2.5	3.9 mm	25	1816130000
KOSF ZT2.5	2.9 mm	50	1816150000
ZZE ZP2.5	9.9 mm	25	1816140000
SDIS SL 0.6X3.5X100		1	1274660000

DEK 5/5 / WS 10/5

ZTPE 2.5/4AN/4

2.5 mm²

4 pluggable connections

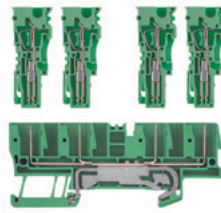

5.1 x 85.5 x 35
/ 4
0.13...4

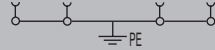

IEC 60947-7-2

IEC	UL	CSA
2.5	AWG 26...12	26...12
690		
500		
	6	
	300 A (2.5 mm ²)	
	3	
	A2 / V-0	

Rated connection	Plug-in connection
0.5...4	
0.5...4 / 0.5...2.5	0.5/ 0.5...2.5
10 / 0.6 x 3.5 mm	

2.5 mm² flexible wires with wire-end ferrules are crimped with the Weidmüller PZ 6/5 crimping tool. UL & CSA D = 600 V / 5 A

Type	Qty.	Order No.
ZTPE 2.5/4AN/4	50	1815140000
Type	Qty.	Order No.
ZP 2.5/1AN/QV/1 GN	50	1820570000

Type	Width	Qty.	Order No.
ZAP/TW ZT2.5/4AN/4	2.5 mm	50	1816090000
ZTA ZT2.5	5.1 mm	25	1827080000
ZTA ZT2.5/ZA	5.1 mm	25	1847600000
ZVR ZP2.5	3.9 mm	25	1816130000
KOSF ZT2.5	2.9 mm	50	1816150000
ZZE ZP2.5	9.9 mm	25	1816140000
SDIS SL 0.6X3.5X100		1	1274660000

DEK 5/5 / WS 10/5

ZTCPE 2.5/4AN/4

2.5 mm²

4 pluggable connections

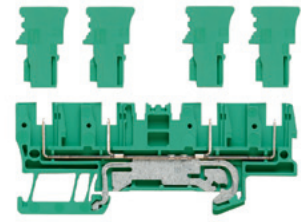

5.1 x 85.5 x 35
/ 2.5
0.5...2.5

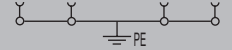

IEC	UL	CSA
2.5		
250		
	4	
	300 A (2.5 mm ²)	
	2	
	/ V-0	

Rated connection	Plug-in connection
0.5...2.5	
/	

2.5 mm² flexible wires with wire-end ferrules are crimped with the Weidmüller PZ 6/5 crimping tool. UL & CSA D = 600 V / 5 A

Type	Qty.	Order No.
ZTCPE 2.5/4AN/4	50	1898480000
Type	Qty.	Order No.
STGH ZPC2.5 DB	50	2321640000

Type	Width	Qty.	Order No.
ZAP/TW ZT2.5/4AN/4	2.5 mm	50	1816090000

DEK 5/5 / WS 10/5

Modular PE terminals

In hazardous area applications, the installation instructions and the rated data specifications for accessories given in the technical appendix must be followed.

Width/Length/Height of lowest version	mm
max. current / max. cond. cross-section	A/mm ²
Max. clamping range	mm ²

Technical data

Rated data	
Rated cross-section	mm ²
Max. voltage of clamp support & pluggable system	V
Rated voltage to adjoining terminal	V
Rated impulse withstand voltage to adjacent terminal	kV
Rated short-time current	
Pollution severity	
Gauge to IEC 60947-1 / Flammability class UL94	
Approvals	
Clamped conductors (H05V/H07V)	
Solid / stranded	mm ²
Flexible / Flexible with ferrule	mm ²
Stripping length / Blade size	mm/-

Note

Ordering data

Base terminal	
	green/yellow Wemid
Plug-in connector	
	1-pole
Note	

Accessories

End plate / Partition plate	
	Dark beige Wemid
	Orange Wemid
Test adapter	
	Standard
	With assembly peg
Miscellaneous accessories WeiCoS	
	Locking element
	Coding element
	Strain relief
Screwdriver	
	Standard

Identification systems	
	(see assortment in catalogue 7)
	Marking tags
Note	

ZTPE 4/2AN/1

4 mm²

1 tension clamp connection / 1 pluggable connection

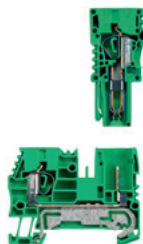

6.5 x 58 x 43.5
/ 6
0.13...6

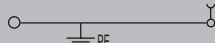

IEC	UL	CSA
4	AWG 26...10	AWG 26...10
800		
800		
	8	
	480 A (4 mm ²)	
	3	
	A3 / V-0	

Rated connection		Plug-in connection	
0.5...6			
0.5...6 / 0.5...4		/ 0.5...4	
12 / 0.6 x 3.5 mm			

Type	Qty.	Order No.
ZTPE 4/2AN/1	50	1854970000
Type	Qty.	Order No.
ZP 2.5/1AN/QV/1 GN	50	1820570000

Type	Width	Qty.	Order No.
ZAP/TW ZT4/2AN	3.25 mm	50	1855220000
ZAP/TW ZT4/2AN OR	3.25 mm	50	1855230000
Type	Width	Qty.	Order No.
ZVR ZP4	5.5 mm	25	1855250000
KOSF ZT4	5.4 mm	50	1856860000
ZZE ZP4	12.5 mm	25	1855260000
Type	Width	Qty.	Order No.
SDIS SL 0.6X3.5X100		1	1274660000

Identification systems	
	(see assortment in catalogue 7)
	Marking tags
	DEK 5/6 / WS 10/6
Note	

ZTPE 4/4AN/2

4 mm²

2 tension clamp connections / 2 pluggable connections

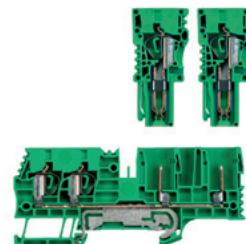

6.5 x 100.5 x 43.5
/ 6
0.13...6



IEC	UL	CSA
4	AWG 26...10	AWG 26...10
800		
800		
	8	
	480 A (4 mm ²)	
	3	
	A3 / V-0	

Rated connection		Plug-in connection	
0.5...6			
0.5...6 / 0.5...4		/ 0.5...4	
12 / 0.6 x 3.5 mm			

Type	Qty.	Order No.
ZTPE 4/4AN/2	50	1848330000
Type	Qty.	Order No.
ZP 2.5/1AN/QV/1 GN	50	1820570000

Type	Width	Qty.	Order No.
ZAP/TW ZT4/4AN/2 OR	3.25 mm	50	1855240000
Type	Width	Qty.	Order No.
ZVR ZP4	5.5 mm	25	1855250000
KOSF ZT4	5.4 mm	50	1856860000
ZZE ZP4	12.5 mm	25	1855260000
Type	Width	Qty.	Order No.
SDIS SL 0.6X3.5X100		1	1274660000

Identification systems	
	(see assortment in catalogue 7)
	Marking tags
	DEK 5/6 / WS 10/6
Note	

Pluggable standard terminals WeiCoS

Two-tier modular terminals

WeiCoS - Pluggable terminal blocks for wire cross-sections from 0.13 to 4 mm².

In hazardous area applications, the installation instructions and the rated data specifications for accessories given in the technical appendix must be followed.

Width/Length/Height of lowest version	mm
max. current / max. cond. cross-section	A/mm ²
Max. clamping range	mm ²

Technical data

Rated data	
Rated voltage	V
Max. voltage of clamp support & pluggable system	V
Rated current	A
Rated cross-section	mm ²
Rated impulse withstand voltage / Pollution severity	
Gauge to IEC 60947-1 / Flammability class UL94	
Approvals	
Clamped conductors (H05V/H07V)	
Solid / stranded	mm ²
Flexible / Flexible with ferrule	mm ²
Stripping length / Blade size	mm/-
Note	

Ordering data

Base terminal	
	Dark beige Wemid
Plug-in connector	
	1-pole
	2-pole
	3-pole
	4-pole
	5-pole
	6-pole
	7-pole
	8-pole
	9-pole
	10-pole
Note	

Accessories

Pluggable cross-connection	
	2-pole
	3-pole
	4-pole
	10-pole
	20-/24-pole
End plate / Partition plate	
	Dark beige Wemid
Test adapter	
	Standard
	With assembly peg
Miscellaneous accessories WeiCoS	
	Locking element
	Coding element
	Strain relief
Screwdriver	
	Standard
Identification systems	
	(see assortment in catalogue 7)
	Marking tags
Note	

ZDT 2.5/2

2.5 mm²

Two potentials feasible

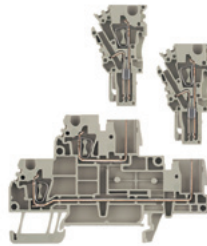

5.1 x 80.5 x 52.5
24 / 4
0.13...4

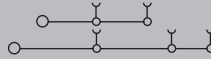

IEC 60947-7-1, IEC 61984

IEC	UL	CSA
500	300 (C)	300 (C)
690		
24	20 (C)	20 (C)
2.5	AWG 26...12	26...12
6 kV / 3		
A2 / V-0		
Rated connection		Plug-in connection
0.5...4		
0.5...4 / 0.5...2.5		0.5/ 0.5...2.5
10 / 0.6 x 3.5 mm		
2.5 mm ² flexible wires with wire-end ferrules are crimped with the Weidmüller PZ 6/5 crimping tool.		

Type	Qty.	Order No.
ZDT 2.5/2	50	1815150000
Type	Qty.	Order No.
ZP 2.5/1AN/QV/1	50	1815190000
ZP 2.5/1AN/QV/2	25	1815200000
ZP 2.5/1AN/QV/3	25	1815210000
ZP 2.5/1AN/QV/4	25	1815220000
ZP 2.5/1AN/QV/5	25	1815230000
ZP 2.5/1AN/QV/6	25	1815240000
ZP 2.5/1AN/QV/7	25	1815250000
ZP 2.5/1AN/QV/8	20	1815260000
ZP 2.5/1AN/QV/9	20	1815270000
ZP 2.5/1AN/QV/10	20	1815280000

Type	current	Qty.	Order No.
ZQV 2.5N/2 GE	24 A	60	1693800000
ZQV 2.5N/3 GE	24 A	60	1693810000
ZQV 2.5N/4 GE	24 A	60	1693820000
ZQV 2.5N/10 GE	24 A	20	1693880000
ZQV 2.5N/20 GE	24 A	20	1909000000
		Width	
ZAP/TW ZDT2.5/2	2.5 mm	50	1816110000
		Width	
ZTA ZT2.5	5.1 mm	25	1827080000
ZTA ZT2.5/ZA	5.1 mm	25	1847600000
ZVR ZP2.5	3.9 mm	25	1816130000
KOSF ZT2.5	2.9 mm	50	1816150000
ZZE ZP2.5	9.9 mm	25	1816140000
SDIS SL 0.6X3.5X100		1	1274660000

DEK 5/5

ZDT 2.5/8AN/4

2.5 mm²

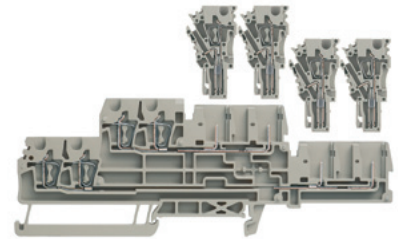

5.2 x 145 x 52.5
/ 4
0.5...4

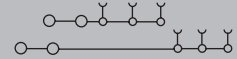

IEC	UL	CSA
500		
690		
24		
2.5		
6 kV / 3		
A2 / V-0		
Rated connection		Plug-in connection
0.5...4 / 0.5...4		
0.5...4 / 0.5...2.5		0.5/ 0.5...2.5
10 / 0.6 x 3.5 mm		
2.5 mm ² flexible wires with wire-end ferrules are crimped with the Weidmüller PZ 6/5 crimping tool.		

Type	Qty.	Order No.
ZDT 2.5/8AN/4	50	1259120000
Type	Qty.	Order No.
ZP 2.5/1AN/QV/1	50	1815190000
ZP 2.5/1AN/QV/2	25	1815200000
ZP 2.5/1AN/QV/3	25	1815210000
ZP 2.5/1AN/QV/4	25	1815220000
ZP 2.5/1AN/QV/5	25	1815230000
ZP 2.5/1AN/QV/6	25	1815240000
ZP 2.5/1AN/QV/7	25	1815250000
ZP 2.5/1AN/QV/8	20	1815260000
ZP 2.5/1AN/QV/9	20	1815270000
ZP 2.5/1AN/QV/10	20	1815280000

Type	current	Qty.	Order No.
ZQV 2.5N/2 GE	24 A	60	1693800000
ZQV 2.5N/3 GE	24 A	60	1693810000
ZQV 2.5N/4 GE	24 A	60	1693820000
ZQV 2.5N/10 GE	24 A	20	1693880000
ZQV 2.5N/20 GE	24 A	20	1909000000
		Width	
ZAP/TW ZDT2.5/2	2.5 mm	50	1816110000
		Width	
ZTA ZT2.5	5.1 mm	25	1827080000
ZTA ZT2.5/ZA	5.1 mm	25	1847600000
ZVR ZP2.5	3.9 mm	25	1816130000
KOSF ZT2.5	2.9 mm	50	1816150000
ZZE ZP2.5	9.9 mm	25	1816140000
SDIS SL 0.6X3.5X100		1	1274660000

DEK 5/5

ZDT 2.5/2 DU-PE

2.5 mm²

Phase - PE conductor



5.1 x 80.5 x 52.5
24 / 4
0.13...4

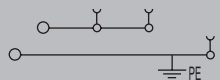

IEC 60947-7-1 (-7-2), IEC 61984

IEC	UL	CSA
500	300 (C)	300 (C)
690		
24	20 (C)	20 (C)
2.5	AWG 26...12	26...12
6 kV / 3		
A2 / V-0		

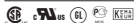

Rated connection	Plug-in connection
0.5...4	
0.5...4 / 0.5...2.5	0.5 / 0.5...2.5
10 / 0.6 x 3.5 mm	

2.5 mm² flexible wires with wire-end ferrules are crimped with the Weidmüller PZ 6/5 crimping tool.

Type	Qty.	Order No.
ZDT 2.5/2 DU-PE	50	1815160000
Type	Qty.	Order No.
ZP 2.5/1AN/QV/1	50	1815190000
ZP 2.5/1AN/QV/2	25	1815200000
ZP 2.5/1AN/QV/3	25	1815210000
ZP 2.5/1AN/QV/4	25	1815220000
ZP 2.5/1AN/QV/5	25	1815230000
ZP 2.5/1AN/QV/6	25	1815240000
ZP 2.5/1AN/QV/7	25	1815250000
ZP 2.5/1AN/QV/8	20	1815260000
ZP 2.5/1AN/QV/9	20	1815270000
ZP 2.5/1AN/QV/10	20	1815280000

Type	current	Qty.	Order No.
ZQV 2.5N/2 GE	24 A	60	1693800000
ZQV 2.5N/3 GE	24 A	60	1693810000
ZQV 2.5N/4 GE	24 A	60	1693820000
ZQV 2.5N/10 GE	24 A	20	1693880000
ZQV 2.5N/20 GE	24 A	20	1909000000
Width			
ZAP/TW ZDT2.5/2	2.5 mm	50	1816110000
ZTA ZT2.5	5.1 mm	25	1827080000
ZTA ZT2.5/ZA	5.1 mm	25	1847600000
ZVR ZP2.5	3.9 mm	25	1816130000
KOSF ZT2.5	2.9 mm	50	1816150000
ZZE ZP2.5	9.9 mm	25	1816140000
SDIS SL 0.6X3.5X100		1	1274660000

DEK 5/5

Pluggable standard terminals WeiCoS

Two-tier modular terminals

WeiCoS - Pluggable terminal blocks for wire cross-sections from 0.13 to 4 mm².

In hazardous area applications, the installation instructions and the rated data specifications for accessories given in the technical appendix must be followed.

Width/Length/Height of lowest version	mm
max. current / max. cond. cross-section	A/mm ²
Max. clamping range	mm ²

Technical data

Rated data	
Rated cross-section	mm ²
Max. voltage of clamp support & pluggable system	V
Rated voltage to adjoining terminal	V
Rated impulse withstand voltage to adjacent terminal	kV
Rated short-time current	
Pollution severity	
Gauge to IEC 60947-1 / Flammability class UL94	
Approvals	
Clamped conductors (H05V/H07V)	
Solid / stranded	mm ²
Flexible / Flexible with ferrule	mm ²
Stripping length / Blade size	mm/-

Note

Ordering data

Version	
	green/yellow Wemid
Plug-in connector	
	1-pole
Note	

Accessories

End plate / Partition plate	
	Dark beige Wemid
Test adapter	
	Standard
	With assembly peg
Miscellaneous accessories WeiCoS	
	Locking element
	Coding element
	Strain relief
Screwdriver	
	Standard

Identification systems	
	(see assortment in catalogue 7)
	Marking tags
Note	

ZDT 2.5/2 PE

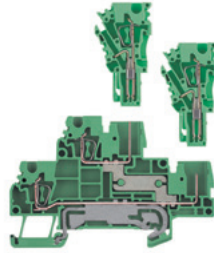
2.5 mm²
2 tension clamp connections / 2 pluggable connections

5.1 x 80.5 x 52.5
/ 4
0.13...4

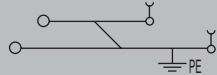

IEC 60947-7-2

IEC	UL	CSA
2.5	AWG 26...12	26...12
690		
500		
6		
300 A (2.5 mm ²)		
3		
A2 / V-0		



Rated connection	Plug-in connection
0.5...4	
0.5...4 / 0.5...2.5	0.52.5
10 / 0.6 x 3.5 mm	

2.5 mm² flexible wires with wire-end ferrules are crimped with the Weidmüller PZ 6/5 crimping tool.

Type	Qty.	Order No.
ZDT 2.5/2 PE	50	1815170000
Type	Qty.	Order No.
ZP 2.5/1AN/QV/1 GN	50	1820570000

Type	Width	Qty.	Order No.
ZAP/TW ZDT2.5/2	2.5 mm	50	1816110000
ZTA ZT2.5	5.1 mm	25	1827080000
ZTA ZT2.5/ZA	5.1 mm	25	1847600000
ZVR ZP2.5	3.9 mm	25	1816130000
KOSF ZT2.5	2.9 mm	50	1816150000
ZZE ZP2.5	9.9 mm	25	1816140000
SDIS SL 0.6X3.5X100		1	1274660000

DEK 5/5 / WS 10/5

Test-disconnect terminals

ZTTR 2.5

2.5 mm²

2 tension clamp connections / 1 pluggable connection

In hazardous area applications, the installation instructions and the rated data specifications for accessories given in the technical appendix must be followed.

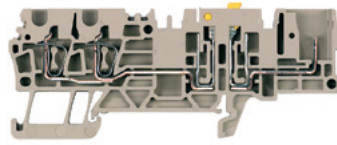

Width/Length/Height of lowest version	mm
max. current / max. cond. cross-section	A/mm ²
Max. clamping range	mm ²

5.1 x 87 x 36.5
18 / 4
0.13...4

Technical data

Rated data	
Rated voltage	V
Rated current	A
Rated cross-section	mm ²
Rated impulse withstand voltage / Pollution severity	
Gauge to IEC 60947-1 / Flammability class UL94	
Approvals	
Clamped conductors (H05V/H07V)	
Solid / stranded	mm ²
Flexible / Flexible with ferrule	mm ²
Stripping length / Blade size	mm/-
Note	

IEC 60947-7-1, IEC 61984

IEC	UL	CSA
400	600 (C)	300 (B)
16	16 (C)	16 (B)
2.5	AWG 26...12	AWG 26...12
6 kV / 3		
A2 / V-0		

Rated connection	
0.5...4	
0.5...4 / 0.5...2.5	
10 / 0.6 x 3.5 mm	

CSA current and voltage, acc. to Gr. B

Ordering data

Version	
	Dark beige Wemid
	Without isolator, Dark beige Wemid
Note	

Type	Qty.	Order No.
ZTTR 2.5	50	1865510000
ZTTR 2.5 0.TNHE	50	1905470000

Please contact customer support when planning your installation with SIHA.

Accessories

Pluggable cross-connection	
	2-pole
	3-pole
	4-pole
	10-pole
End plate / Partition plate	
	Dark beige Wemid
End bracket	
	Dark beige Wemid
Screwdriver	
	Standard
Testing / Checking	
	Test plug
Holder for cartridge fuse 5 x 20mm	
	400 V AC/DC, without LED
	10 - 36 V AC/DC, red LED
	140 - 250 V AC/DC, red LED
Module connector (max, 250 V)	
	without fittings
	with wire jumper
	With 1N4007 diode
Disconnect plug	
	removable, as replacement for release lever
Identification systems (see assortment in catalogue 7)	
	Marking tags
Note	

Type	current	Qty.	Order No.
ZQV 2.5N/2 GE	24 A	60	1693800000
ZQV 2.5N/3 GE	24 A	60	1693810000
ZQV 2.5N/4 GE	24 A	60	1693820000
ZQV 2.5N/10 GE	24 A	20	1693880000
Width			
ZAP/TW ZTTR2.5	2.5 mm	50	1865520000
ZEW 35	6 mm	20	9540000000
SDIS SL 0.6X3.5X100		1	1274660000
PS 2.3 RT	5.4 mm	20	0180400000
SIHA 3/G20	5.95 mm	25	7921560000
SIHA 3/G20/LD 10-36V	5.95 mm	25	7921570000
SIHA 3/G20/LD 140-250V	5.95 mm	25	7921600000
BEST	5.1 mm	50	1833100000
BEST/DRBR	5.1 mm	50	1878570000
BEST/D	5.1 mm	50	1878560000
TNST		50	1833090000

DEK 5/5
2.5 mm ² flexible wires with wire-end ferrules are crimped with the Weidmüller PZ 6/5 crimping tool.

Pluggable standard terminals WeiCoS

Feed-through modular terminals

Z-series standard ranges provide solutions for conductor cross-sections from 0.05 to 35 mm².

In hazardous area applications, the installation instructions and the rated data specifications for accessories given in the technical appendix must be followed.

Width/Length/Height of lowest version	mm
max. current / max. cond. cross-section	A/mm ²
Max. clamping range	mm ²

Technical data

Rated data	
Rated voltage	V
Rated current	A
Rated cross-section	mm ²
Rated impulse withstand voltage / Pollution severity	
Gauge to IEC 60947-1 / Flammability class UL94	
Approvals	
Clamped conductors (H05V/H07V)	
Solid / stranded	mm ²
Flexible / Flexible with ferrule	mm ²
Stripping length / Blade size	mm/-
Note	

Ordering data

Version	Type	Qty.	Order No.
	Base terminal		
Note			

Accessories

Pluggable cross-connection	
	2-pole 3-pole 4-pole 10-pole 20-/24-pole
STGH plug housing	
	With assembly peg Without peg
Crimp contacts	
	Reel packaged Single contacts
Test adapter	
	Strain relief Plug housing black Black plug enclosure
End plate / Partition plate	
	beige Wemid
Tools	
	Crimping tool Mounting tool
Identification systems (see assortment in catalogue 7)	
	Marking tags
Note	

ZRV 1.5

1.5 mm²

Base terminal - plug

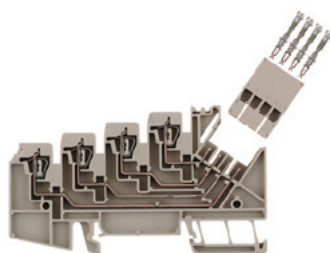

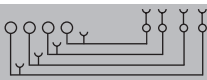
5.1 x 89.5 x 52.5	
/ 2.5	
0.13...2.5	

IEC 60947-7-1, IEC 61984

IEC	UL	CSA
63	150 (C)	
4	10 (C)	
1.5	AWG 26...14	
1.5 kV / 3		
A1 / V-0		
Approvals		
Rated connection		
0.5...2.5	Crimp connection	
0.5...2.5 / 0.5...1.5	0.5...2.5	
8 / 0.6 x 3.5 mm		
Note		

Type	Qty.	Order No.
ZRV 1.5	50	1698160000
Note		

Type	current	Qty.	Order No.
STGH 4 ZRV1.5	5 mm	50	1698190000
Width			
DFFC 0.2-0.35 ZRV1.5		500	1705310000
DFFC .5-1.0 ZRV1.5		500	1705320000
HTF ZRV		1	9014840000
Note			

DEK 5/5	
Note	

ZRV 1,5/PE

1.5 mm²

Base terminal - plug

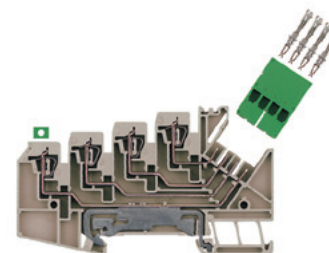

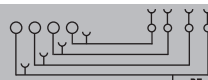
5.1 x 89.5 x 52.5	
/ 2.5	
0.13...2.5	

IEC 60947-7-1 (-7-2), IEC 61984

IEC	UL	CSA
63	150 (C)	
4	10 (C)	
1.5	AWG 26...14	
1.5 kV / 3		
A1 / V-0		
Approvals		
Rated connection		
0.5...2.5	Crimp connection	
0.5...2.5 / 0.5...1.5	0.5...2.5	
8 / 0.6 x 3.5 mm		
Note		

Type	Qty.	Order No.
ZRV 1.5/PE	50	1698170000
Note		

Type	current	Qty.	Order No.
STGH 4 ZRV1.5/PE GN	5 mm	50	1698200000
DFFC 0.2-0.35 ZRV1.5		500	1705310000
DFFC .5-1.0 ZRV1.5		500	1705320000
HTF ZRV		1	9014840000
Note			

DEK 5/5	
Note	

ZRV 2.5/2

2.5 mm²

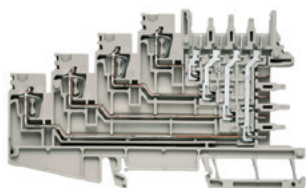

5.2 x 115 x 70
10 / 4
0.21...4

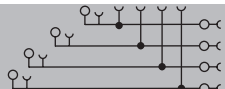

IEC 60947-7-1, IEC 61984

IEC	UL	CSA
250	300 (C)	300 (D)
10	10 (C)	10 (D)
2.5	AWG 24...14	AWG 26...14
4 kV / 3		
A2 / V-0		

Rated connection		Crimp connection
0.5...4 / 0.5...4		
0.5...2.5 / 0.5...2.5		0.5...2.5
10 / 0.6 x 3.5 mm		

Type	Qty.	Order No.
ZRV 2.5/2	50	1906970000

Type	current	Qty.	Order No.
ZQV 2.5/2	24 A	60	1608860000
ZQV 2.5/3	24 A	60	1608870000
ZQV 2.5/4	24 A	60	1608880000
ZQV 2.5/10	24 A	20	1608940000
ZQV 2.5/20	24 A	20	1908960000
Width			
STGH ZRV2.5	5.15 mm	50	1907000000
STGH O.ZA ZRV2.5	5.15 mm	50	1907010000
FEKO ZRV2.5 0.2-0.35	4.15 mm	5000	1854750000
FEKO ZRV2.5 0.5-1	4.15 mm	5000	1854760000
FEKO ZRV2.5 1.5-2.5	4.15 mm	4000	1848480000
FEKO ET ZRV2.5 0.2-0.35	4.15 mm	500	1893940000
FEKO ET ZRV2.5 0.5-1	4.15 mm	500	1893970000
FEKO ET ZRV2.5 1.5-2.5	4.15 mm	500	1893990000
ZE ZRV2.5	5 mm	25	2318670000
STGH O.R/SW ZRV2.5	5.15 mm	25	1898420000
STGH O.ZA/O.R/SW ZRV2.5	5.15 mm	25	1898430000
AP ZRV2.5	5.1 mm	10	1906980000
HTF AFK 2.5		1	9201040000
Removal Tool AFK		1	1866760000

DEK 5/5 / WS 12/5

ZRV 2.5/1

2.5 mm²

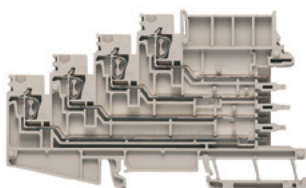

5.2 x 115 x 70
/ 4
0.5...4

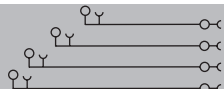

IEC	UL	CSA
250	300 (C)	
10	10 (C)	
2.5	AWG 24...14	
4 kV / 3		
/ V-0		

Rated connection		Crimp connection
0.5...4		
0.5...2.5		0.5...2.5
10 / 0.6 x 3.5 mm		

Type	Qty.	Order No.
ZRV 2.5/1	50	1906960000

Type	current	Qty.	Order No.
ZQV 2.5/2	24 A	60	1608860000
ZQV 2.5/3	24 A	60	1608870000
ZQV 2.5/4	24 A	60	1608880000
ZQV 2.5/10	24 A	20	1608940000
ZQV 2.5/20	24 A	20	1908960000
Width			
STGH ZRV2.5	5.15 mm	50	1907000000
STGH O.ZA ZRV2.5	5.15 mm	50	1907010000
FEKO ZRV2.5 0.2-0.35	4.15 mm	5000	1854750000
FEKO ZRV2.5 0.5-1	4.15 mm	5000	1854760000
FEKO ZRV2.5 1.5-2.5	4.15 mm	4000	1848480000
FEKO ET ZRV2.5 0.2-0.35	4.15 mm	500	1893940000
FEKO ET ZRV2.5 0.5-1	4.15 mm	500	1893970000
FEKO ET ZRV2.5 1.5-2.5	4.15 mm	500	1893990000
ZE ZRV2.5	5 mm	25	2318670000
STGH O.R/SW ZRV2.5	5.15 mm	25	1898420000
STGH O.ZA/O.R/SW ZRV2.5	5.15 mm	25	1898430000
AP ZRV2.5	5.1 mm	10	1906980000
HTF AFK 2.5		1	9201040000
Removal Tool AFK		1	1866760000

DEK 5/5 / WS 12/5

Pluggable standard terminals WeiCoS

Plug-in connector

In hazardous area applications, the installation instructions and the rated data specifications for accessories given in the technical appendix must be followed.

Width/Length/Height of lowest version	mm
max. current / max. cond. cross-section	A/mm ²
Max. clamping range	mm ²



Technical data

Rated data	
Rated voltage	V
Rated current	A
Rated cross-section	mm ²
Rated impulse withstand voltage / Pollution severity Gauge to IEC 60947-1 / Flammability class UL94	
Approvals	
Clamped conductors (H05V/H07V)	
Solid / stranded	mm ²
Flexible / Flexible with ferrule	mm ²
Stripping length / Blade size	mm/-
Note	

Ordering data

Version	Type	Qty.	Order No.
1-pole	ZP 2.5/1AN/1	50	1815430000
2-pole	ZP 2.5/1AN/2	25	1815440000
3-pole	ZP 2.5/1AN/3	25	1815450000
4-pole	ZP 2.5/1AN/4	25	1815500000
5-pole	ZP 2.5/1AN/5	25	1815510000
6-pole	ZP 2.5/1AN/6	25	1815520000
7-pole	ZP 2.5/1AN/7	25	1815530000
8-pole	ZP 2.5/1AN/8	20	1815540000
9-pole	ZP 2.5/1AN/9	20	1815550000
10-pole	ZP 2.5/1AN/10	20	1815560000
11-pole	ZP 2.5/1AN/11	20	1815570000
12-pole	ZP 2.5/1AN/12	20	1815580000
13-pole	ZP 2.5/1AN/13	10	1815590000
14-pole	ZP 2.5/1AN/14	10	1815600000
15-pole	ZP 2.5/1AN/15	10	1815610000
16-pole	ZP 2.5/1AN/16	10	1815620000
17-pole	ZP 2.5/1AN/17	10	1815180000
24-pole	ZP 2.5/1AN/24	10	1815720000
1-pole (green Wemid)	ZP 2.5/1AN/1 GN	50	1820580000
Note			

Accessories

Pluggable cross-connection	
	2-pole
	3-pole
	10-pole
Test adapter	
	Standard
Screwdriver	
	Standard
Group designation	
Group designation	ZGB 30
Protective strips transparent	STR 7 F.SCHT 7
Push-in tag blank	ESO 7 A4-BOGEN WEISS
Identification systems (see assortment in catalogue 7)	
Marking tags	DEK 5/5 / WS 10/5
Note	

ZP 2.5/1AN

2.5 mm²

1...17-pole

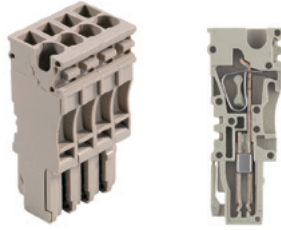

5.1 x 16 x 41
24 / 4
0.13...4

IEC 60947-7-1, IEC 61984

IEC	UL	CSA
500	300 (C)	300 (C)
24	20 (C)	20 (C)
2.5	AWG 26...12	26...12
6 kV / 3		
A2 / V-0		
Rated connection		
0.5...4		
0.5...4 / 0.5...2.5		
10 / 0.6 x 3.5 mm		
2.5 mm ² flexible wires with wire-end ferrules are crimped with the Weidmüller PZ 6/5 crimping tool.		

Type	Qty.	Order No.
ZP 2.5/1AN/1	50	1815430000
ZP 2.5/1AN/2	25	1815440000
ZP 2.5/1AN/3	25	1815450000
ZP 2.5/1AN/4	25	1815500000
ZP 2.5/1AN/5	25	1815510000
ZP 2.5/1AN/6	25	1815520000
ZP 2.5/1AN/7	25	1815530000
ZP 2.5/1AN/8	20	1815540000
ZP 2.5/1AN/9	20	1815550000
ZP 2.5/1AN/10	20	1815560000
ZP 2.5/1AN/11	20	1815570000
ZP 2.5/1AN/12	20	1815580000
ZP 2.5/1AN/13	10	1815590000
ZP 2.5/1AN/14	10	1815600000
ZP 2.5/1AN/15	10	1815610000
ZP 2.5/1AN/16	10	1815620000
ZP 2.5/1AN/17	10	1815180000
ZP 2.5/1AN/24	10	1815720000
ZP 2.5/1AN/1 GN	50	1820580000

Type	current	Qty.	Order No.
Width			
ZTA ZT2.5	5.1 mm	25	1827080000
SDIS SL 0.6X3.5X100		1	1274660000
ZGB 30	7 mm	20	1611930000
STR 7 F.SCHT 7	6.3 mm	20	0515300000
ESO 7 A4-BOGEN WEISS	6.3 mm	10	1607720000

DEK 5/5 / WS 10/5

ZP 2.5/1AN/GN/BE

2.5 mm²

2 to 17-pole

Connectors each with one green pole

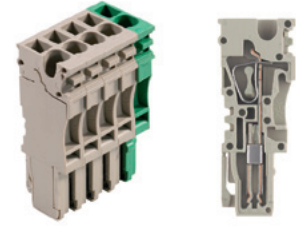

5.1 x 16 x 41
24 / 4
0.13...4

IEC 60947-7-1, IEC 61984

IEC	UL	CSA
500	300 (C)	300 (C)
24	20 (C)	20 (C)
2.5	AWG 26...12	26...12
6 kV /		
A2 / V-0		
Rated connection		
0.5...4		
0.5...4 / 0.5...2.5		
10 / 0.6 x 3.5 mm		
2.5 mm ² flexible wires with wire-end ferrules are crimped with the Weidmüller PZ 6/5 crimping tool.		

Type	Qty.	Order No.
ZP 2.5/1AN/2 GN/BE	25	1867090000
ZP 2.5/1AN/3 GN/BE	25	1867100000
ZP 2.5/1AN/4 GN/BE	25	1867110000
ZP 2.5/1AN/5 GN/BE	25	1867120000
ZP 2.5/1AN/6 GN/BE	25	1867130000
ZP 2.5/1AN/7 GN/BE	25	1867140000
ZP 2.5/1AN/8 GN/BE	20	1867150000
ZP 2.5/1AN/9 GN/BE	20	1867160000
ZP 2.5/1AN/10 GN/BE	20	1867170000
ZP 2.5/1AN/11 GN/BE	20	1867180000
ZP 2.5/1AN/12 GN/BE	20	1867190000
ZP 2.5/1AN/13 GN/BE	10	1867200000
ZP 2.5/1AN/14 GN/BE	10	1867210000
ZP 2.5/1AN/15 GN/BE	10	1867220000
ZP 2.5/1AN/17 GN/BE	10	1867240000

The technical specifications are only valid for use in conjunction with PE terminals, according to DIN EN 60947-7-2.

Type	current	Qty.	Order No.
Width			
ZTA ZT2.5	5.1 mm	25	1827080000
SDIS SL 0.6X3.5X100		1	1274660000
ZGB 30	7 mm	20	1611930000
STR 7 F.SCHT 7	6.3 mm	20	0515300000
ESO 7 A4-BOGEN WEISS	6.3 mm	10	1607720000

DEK 5/5 / WS 10/5

ZP 2.5/1AN/QV

2.5 mm²

1...17-pole

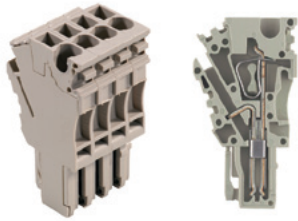

5.1 x 23 x 41
24 / 4
0.13...4

IEC	UL	CSA
500	300 (C)	300 (C)
24	20 (C)	20 (C)
2.5	AWG 26...12	26...12
6 kV / A2 / V-0		

Rated connection	
0.5...4	
0.5...4 / 0.5...2.5	
10 / 0.6 x 3.5 mm	

2.5 mm² flexible wires with wire-end ferrules are crimped with the Weidmüller PZ 6/5 crimping tool.

Type	Qty.	Order No.
ZP 2.5/1AN/QV/1	50	1815190000
ZP 2.5/1AN/QV/2	25	1815200000
ZP 2.5/1AN/QV/3	25	1815210000
ZP 2.5/1AN/QV/4	25	1815220000
ZP 2.5/1AN/QV/5	25	1815230000
ZP 2.5/1AN/QV/6	25	1815240000
ZP 2.5/1AN/QV/7	25	1815250000
ZP 2.5/1AN/QV/8	20	1815260000
ZP 2.5/1AN/QV/9	20	1815270000
ZP 2.5/1AN/QV/10	20	1815280000
ZP 2.5/1AN/QV/11	20	1815290000
ZP 2.5/1AN/QV/12	20	1815300000
ZP 2.5/1AN/QV/13	10	1815310000
ZP 2.5/1AN/QV/14	10	1815320000
ZP 2.5/1AN/QV/15	10	1815330000
ZP 2.5/1AN/QV/16	10	1815340000
ZP 2.5/1AN/QV/17	10	1815350000
ZP 2.5/1AN/QV/1 GN	50	1820570000

Type	current	Qty.	Order No.
ZQV 2.5N/2 GE	24 A	60	1693800000
ZQV 2.5N/3 GE	24 A	60	1693810000
ZQV 2.5N/10 GE	24 A	20	1693880000
Width			
ZTA ZT2.5	5.1 mm	25	1827080000
SDIS SL 0.6X3.5X100		1	1274660000
ZGB 30	7 mm	20	1611930000
STR 7 F.SCHT 7	6.3 mm	20	0515300000
ESD 7 A4-BOGEN WEISS	6.3 mm	10	1607720000

DEK 5/5 / WS 10/5

ZP 2.5/2AN/QV

2.5 mm²

1...16-pole

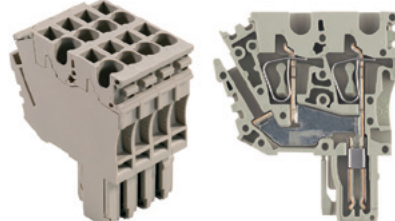

5.1 x 37 x 41
24 / 4
0.13...4

IEC 60947-7-1, IEC 61984

IEC	UL	CSA
500	300 (C)	300 (C)
24	20 (C)	20 (C)
2.5	AWG 26...12	26...12
6 kV / 3 A2 / V-0		

Rated connection	
0.5...4	
0.5...4 / 0.5...2.5	
10 / 0.6 x 3.5 mm	

2.5 mm² flexible wires with wire-end ferrules are crimped with the Weidmüller PZ 6/5 crimping tool.

Type	Qty.	Order No.
ZP 2.5/2AN/QV/1	50	1815730000
ZP 2.5/2AN/QV/2	20	1815740000
ZP 2.5/2AN/QV/3	20	1815750000
ZP 2.5/2AN/QV/4	20	1815760000
ZP 2.5/2AN/QV/5	20	1815770000
ZP 2.5/2AN/QV/6	20	1815780000
ZP 2.5/2AN/QV/7	20	1815790000
ZP 2.5/2AN/QV/8	10	1815800000
ZP 2.5/2AN/QV/9	10	1815810000
ZP 2.5/2AN/QV/10	10	1815820000
ZP 2.5/2AN/QV/11	10	1815830000
ZP 2.5/2AN/QV/12	10	1815840000
ZP 2.5/2AN/QV/13	5	1815850000
ZP 2.5/2AN/QV/14	5	1815860000
ZP 2.5/2AN/QV/15	5	1815870000
ZP 2.5/2AN/QV/16	5	1815880000
ZP 2.5/2AN/QV/1 GN	50	1820590000

Type	current	Qty.	Order No.
ZQV 2.5N/2 GE	24 A	60	1693800000
ZQV 2.5N/3 GE	24 A	60	1693810000
ZQV 2.5N/10 GE	24 A	20	1693880000
Width			
ZTA ZT2.5	5.1 mm	25	1827080000
SDIS SL 0.6X3.5X100		1	1274660000
ZGB 30	7 mm	20	1611930000
STR 7 F.SCHT 7	6.3 mm	20	0515300000
ESD 7 A4-BOGEN WEISS	6.3 mm	10	1607720000

DEK 5/5 / WS 10/5

ZP 4/1AN

4 mm²

1...16-pole

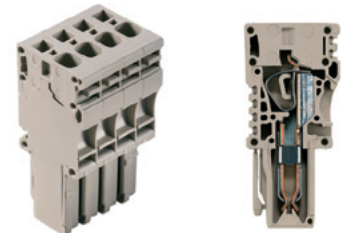

6.5 x 22.5 x 47.5
32 / 6
0.13...6

IEC 60947-7-1, IEC 61984

IEC	UL	CSA
800	600 (C)	600 (C)
32	28 (C)	28 (C)
4	AWG 26...10	AWG 26...10
8 kV / 3 A3 / V-0		

Rated connection	
0.5...6	
0.5...6 / 0.5...4	
12 / 0.6 x 3.5 mm	

CSA current and voltage, acc. to Gr. C

Type	Qty.	Order No.
ZP 4/1AN/1	50	1848340000
ZP 4/1AN/2	25	1854990000
ZP 4/1AN/3	25	1855000000
ZP 4/1AN/4	25	1855010000
ZP 4/1AN/5	20	1855020000
ZP 4/1AN/6	20	1855030000
ZP 4/1AN/7	20	1855040000
ZP 4/1AN/8	20	1855050000
ZP 4/1AN/9	10	1855060000
ZP 4/1AN/10	10	1855070000
ZP 4/1AN/11	20	1855080000
ZP 4/1AN/12	10	1855090000
ZP 4/1AN/13	10	1855100000
ZP 4/1AN/14	10	1855110000
ZP 4/1AN/15	10	1855120000
ZP 4/1AN/16	10	1855130000
ZP 4/1AN/1 GN	50	1854980000

Type	current	Qty.	Order No.
Width			
SDIS SL 0.6X3.5X100		1	1274660000

DEK 5/5 / WS 10/6

WeiCoS – single slice elements

Single slice elements for self-assembly

The WeiCoS single slice elements from Weidmüller enhance flexibility by providing a solution for almost every application. The plug-in connectors are piped together to offer a compact modular solution directly in situ to suit the particular application. These single slices are available in green (GN) and beige (BE).

Single slice element ZP 2.5/1AN plug



Single slice element ZP 2.5/1AN/QV plug



Ordering data

Type	Qty.	Order No.
ZP 2.5/1AN	50	1875150000
ZP 2.5/1AN ZA O.RA	50	1875210000
ZP 2.5/1AN ZA	50	1875190000
ZP 2.5/1AN ZA O.RA BL	50	1972980000
ZP 2.5/1AN ZA BL	50	1009070000
ZP 2.5/1AN GN	50	1875180000
ZP 2.5/1AN ZA O.RA GN	50	1875220000
ZP 2.5/1AN ZA GN	50	1875200000

Ordering data

Type	Qty.	Order No.
ZP 2.5/1AN/QV	50	1007900000
ZP 2.5/1AN/QV ZA O.RA	50	1007960000
ZP 2.5/1AN/QV ZA	50	1007930000
ZP 2.5/1AN/QV BL	50	1007910000
ZP 2.5/1AN/QV ZA O.RA BL	50	1007970000
ZP 2.5/1AN/QV ZA BL	50	1007940000
ZP 2.5/1AN/QV GN	50	1007920000
ZP 2.5/1AN/QV ZA O.RA GN	50	1007980000
ZP 2.5/1AN/QV ZA GN	50	1007950000

Construction of plug:

- | | | |
|------------------------|-------------------------|----------------------|
| 1 start element | n-2 core element | 1 end element |
| 1875150000 BE | 1875210000 BE | 1875190000 BE |
| 1875180000 GN | 1972980000 BL | 1009070000 BL |
| | 1875220000 GN | 1875200000 GN |

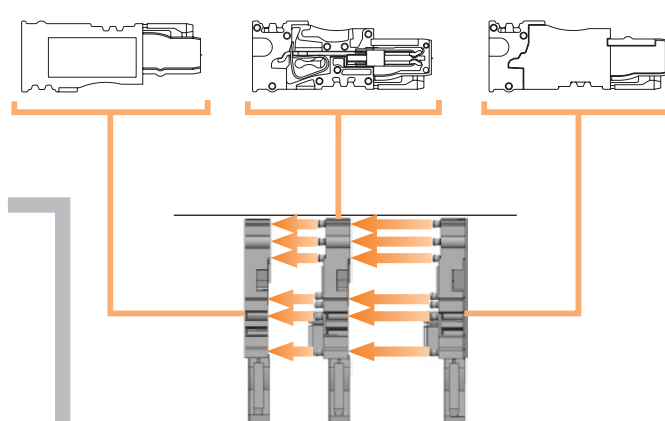

Construction of plug:

- | | | |
|------------------------|-------------------------|----------------------|
| 1 start element | n-2 core element | 1 end element |
| 1007900000 BE | 1007960000 BE | 1007930000 BE |
| 1007910000 BL | 1007970000 BL | 1007940000 BL |
| 1007920000 GN | 1007980000 GN | 1007950000 GN |

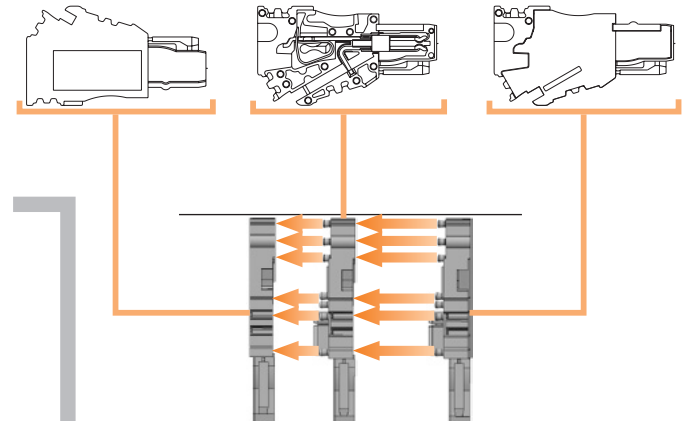

Single slice element ZP 2.5/2AN/QV plug

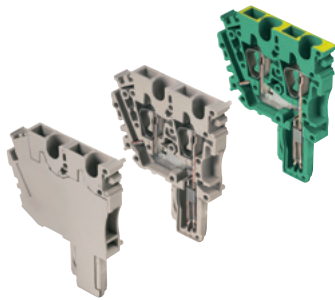

Ordering data

Type	Qty.	Order No.
ZP 2.5/2AN/QV	50	1007810000
ZP 2.5/2AN/QV ZA 0.RA	50	1007870000
ZP 2.5/2AN/QV ZA	50	1007840000
ZP 2.5/2AN/QV BL	50	1007820000
ZP 2.5/2AN/QV ZA0.RA BL	50	1007880000
ZP 2.5/2AN/QV ZA BL	50	1007850000
ZP 2.5/2AN/QV GN	50	1007830000
ZP 2.5/2AN/QV ZA0.RA GN	50	1007890000
ZP 2.5/2AN/QV ZA GN	50	1007860000

Single slice element ZPS coupling



Ordering data

Type	Qty.	Order No.
GHDE ZPS 2.5/1AN	50	1866070000
ZPS 2.5/1AN/QV/1GN	50	1861050000
ZPS 2.5/1AN/QV	50	1861040000

Construction of plug:

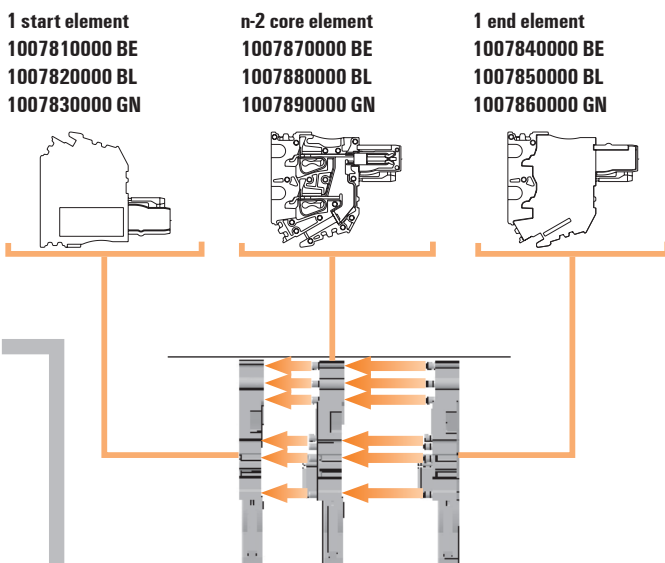

Construction of coupling:

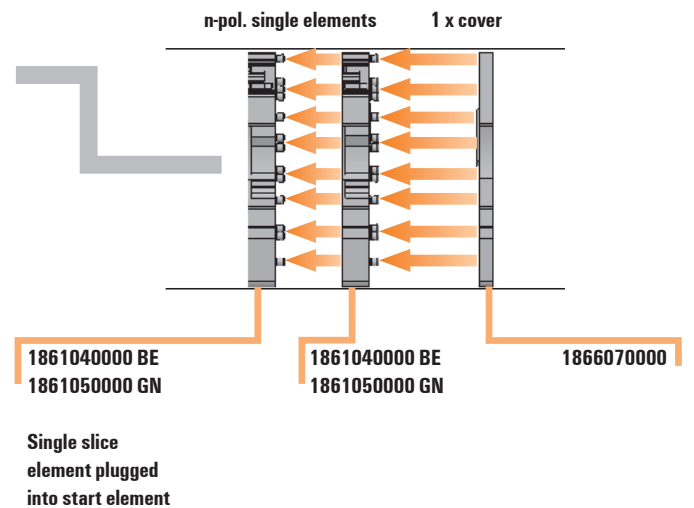

Plug accessories

WeiCoS 2.5 mm²

Locking element

ZVR ZP 2.5

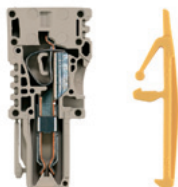

Ordering data	Type	Qty.	Order No.
	ZVR ZP 2.5	25	1816130000

Test adapter

1 x 1827080000 and (n-1) x 1847600000 are required for setting up n-pole blocks.

ZTA ZT 2.5

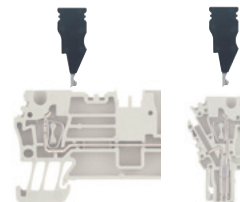

Ordering data	Type	Qty.	Order No.
	ZTA ZT 2.5 (without spigot)	25	1827080000
	ZTA ZT 2.5 (with spigot)	25	1847600000

Coding element

KOSF ZT 2.5

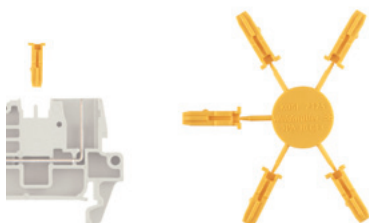

Ordering data	Type	Qty.	Order No.
	KOSF ZT 2.5	50	1816150000

Locking element

ZVR ZP 2.5 in conjunction with separate coupling

ZVR ZPS 2.5



Ordering data	Type	Qty.	Order No.
	ZVR ZPS 2.5	20	1878620000

Strain relief

ZZE ZP 2.5

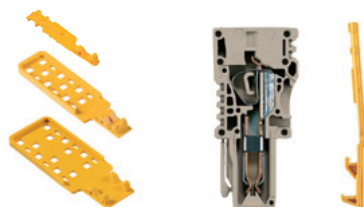

Ordering data	Type	Qty.	Order No.
	ZZE ZP 2.5 - 1-pole	25	1816140000
	ZZE ZP 2.5/4 - 4-pole	25	1866220000
	ZZE ZP 2.5/8 - 8-pole	25	1866230000

Protective cover

ZAD ZT / ZPS 2.5

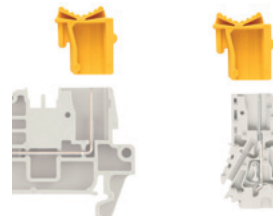

Ordering data	Type	Qty.	Order No.
	ZAD ZT / ZPS 2.5	50	1861030000

Plug accessories

WeiCoS 4 mm²

Locking element

ZVR ZP 4

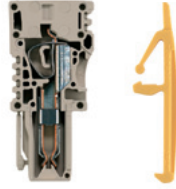

Ordering data	Type	Qty.	Order No.
	ZVR ZP 4	25	1855250000

Coding element

KOSF ZT 4

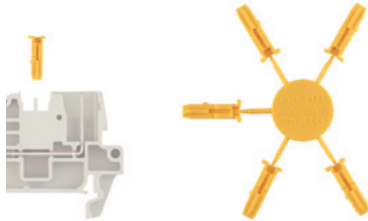

Ordering data	Type	Qty.	Order No.
	KOSF ZT 4	50	1856860000

Strain relief

ZZE ZP 4

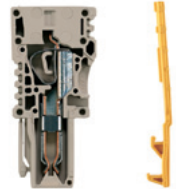

Ordering data	Type	Qty.	Order No.
	ZZE ZP 4	25	1855260000

Mounting set – separate coupling

Individual applications without the use of component parts would be unthinkable in industry today.

Coupled with high temperature and vibration demands, modularity requires the use of specially tested products. Wherever functional units are pre-assembled or have to be quickly separated, flexible systems are high on the agenda. The WeiCoS separate coupling represents a further extension to the Weidmüller modular concept. It is the ideal solution for wiring without “heavyweight” enclosures.

In addition, this separate coupling concept from Weidmüller represents a compact alternative to the through-panel plug-in connector or signal and lighting distribution terminals. Together with the pluggable modular terminals from the WeiCoS range, they form an ideal combination for creating flexible, functional units.

C

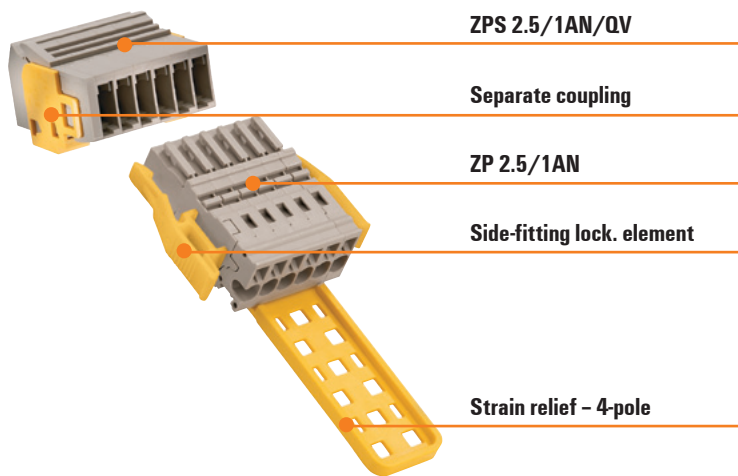

Separate coupling – 3 plugs, 1 line

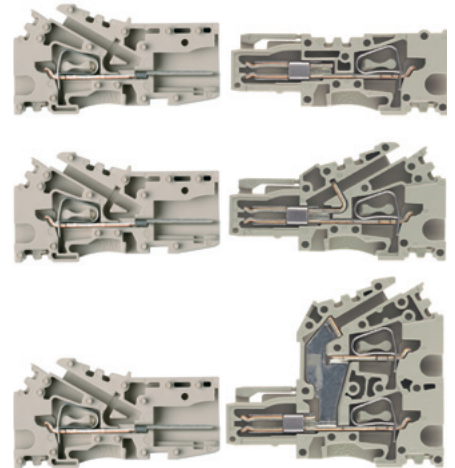

Separate coupling

ZVLA1 ZPS 2.5



Ordering data	Type	Qty.	Order No.
	ZVLA1 ZPS 2.5	20	1866250000

Alternative to the side-fitting locking element, the central locking element

ZVR ZP 2.5



Ordering data	Type	Qty.	Order No.
	ZVR ZP 2.5	20	1816130000

Strain relief

ZZE ZP 2.5 / 4 / 8



Ordering data	Type	Qty.	Order No.
	ZZE ZP 2.5 - 1-pole	25	1816140000
	ZZE ZP 2.5/4 - 4-pole	25	1866220000
	ZZE ZP 2.5/8 - 8-pole	25	1866230000

ZP 2.5/1AN/6



Ordering data	Type	Qty.	Order No.
	ZP 2.5/1AN/6	25	1815520000

Side-fitting locking element

ZVR ZPS 2.5



Ordering data	Type	Qty.	Order No.
	ZVR ZPS 2.5	20	1878620000

ZPS 2.5/1AN/QV 6



Ordering data	Type	Qty.	Order No.
	ZPS 2.5/1AN/QV 6	25	1865940000

Mounting set – coupling

The new options

Although a separate coupling is very useful (enabling a connection to be disconnected at any point), users do not always want them to be quite so readily separable.

We have therefore devised the following fixing variations for separate couplings:

- Screws for fixing to a mounting plate or enclosure wall.
- Clips for fixing to a mounting plate or enclosure wall (in this version every pole can be provided with a clip if required).
- Clips for direct fixing to a terminal rail (TS 15 or TS 35).

Of special note is the fact that the coupling blocks can be supplied already fitted with the fixings you require.

Screwed through-wall fixing

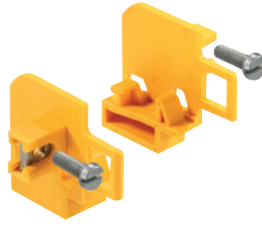

Type	Qty.	Order No.
ZVLA DF ZPS2.5	20	1878600000

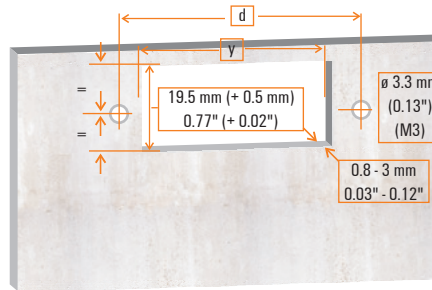
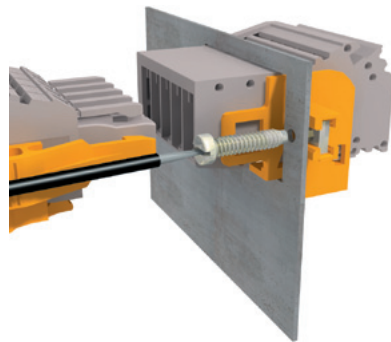

$y = n \times 5.1 \text{ mm} + 5.5 \text{ mm}$ $y = n \times 0.25" + 0.216"$
 $d = n \times 5.1 \text{ mm} + 13.5 \text{ mm}$ $d = n \times 0.25" + 0.53"$

WeiCoS

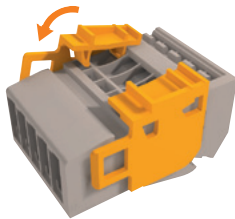

Plug-in connector system with an infinite number of combinations – but always with the same fitting method.

n-pole	y		d	
	mm	inch(")	mm	inch(")
2-pole	15.7	0.62	23.7	0.93
3-pole	20.8	0.82	28.8	1.13
4-pole	25.9	1.02	33.9	1.33
5-pole	31.0	1.22	38.9	1.53
6-pole	36.1	1.42	44.1	1.74
7-pole	41.2	1.62	49.2	1.94
8-pole	46.3	1.82	54.3	2.14
9-pole	51.4	2.02	59.4	2.34
10-pole	56.5	2.22	64.5	2.55
11-pole	61.6	2.43	69.6	2.74
12-pole	66.7	2.63	74.7	2.94
13-pole	71.8	2.83	79.8	3.14
14-pole	76.9	3.03	84.9	3.34
15-pole	82.0	3.23	90.0	3.54
16-pole	87.1	3.43	95.1	3.74

Direct mounting – screwed



Type	Qty.	Order No.
ZVLA SC ZPS 2.5	20	1866240000

Direct mounting – clipped

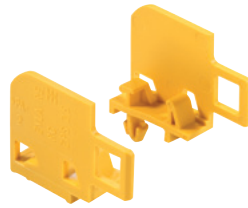

Type	Qty.	Order No.
ZVLA RC ZPS 2.5	20	1866260000

on terminal rail

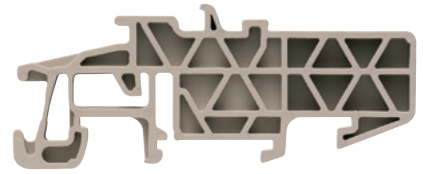

Type	Qty.	Order No.
MOFU 15/35 ZPS 2.5	25	1899170000

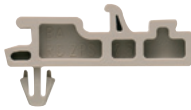

Type	Qty.	Order No.
BA RC ZPS 2.5	100	1908560000



Plug support prevents buckling of the connection

Type	Qty.	Order No.
BA ZPS 2.5	100	1908550000

Plug support prevents buckling of the connection

Type	Qty.	Order No.
BA ZPS 2.5	100	1908550000

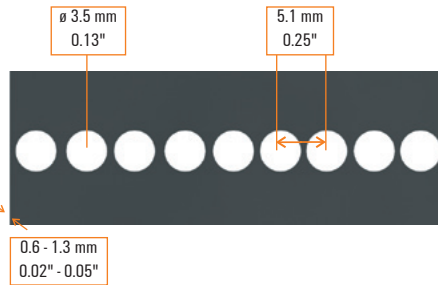
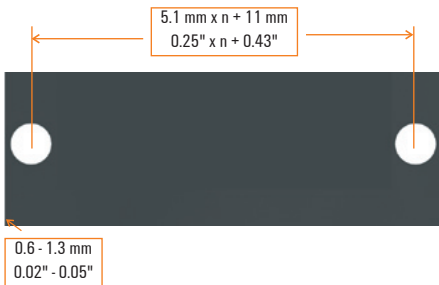
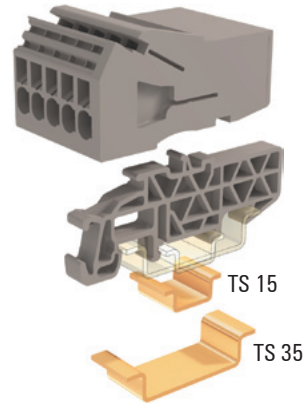
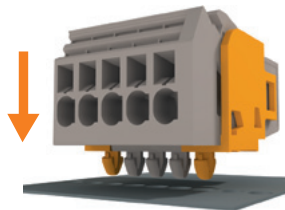
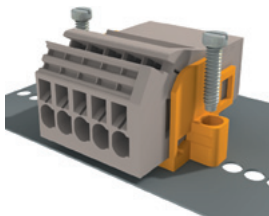

ZT 2.5/2AN/1

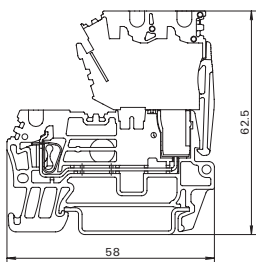
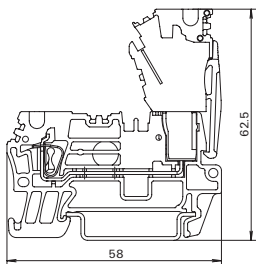
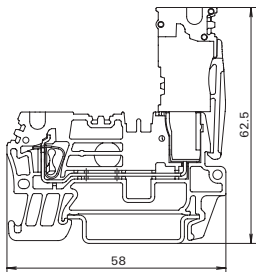
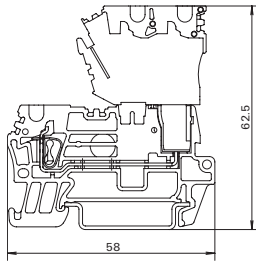
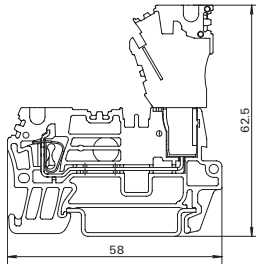
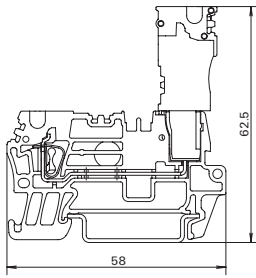

ZT 2.5/3AN/1

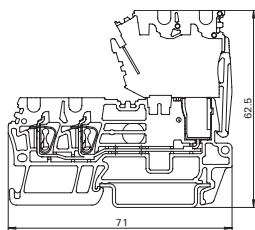
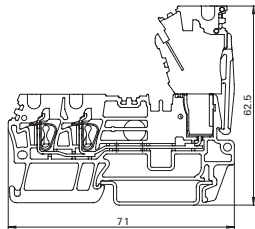
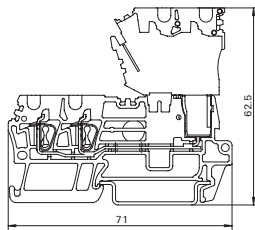
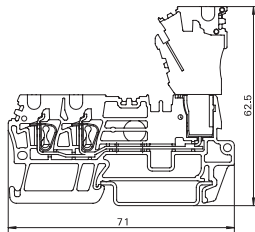

ZTTR 2.5/3AN/1

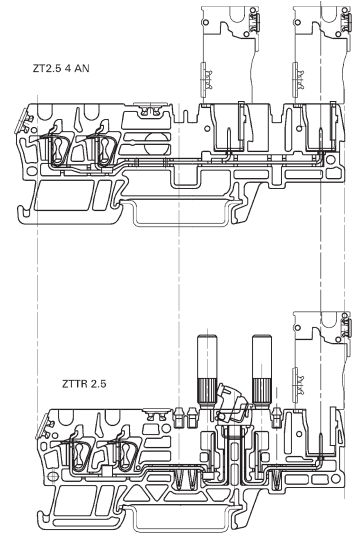

A connector alignment:
the ZTTR can be combined with ZTPE 2.5.

ZT 2.5/4AN/2

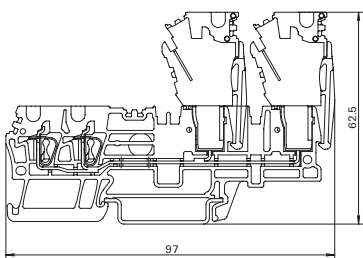
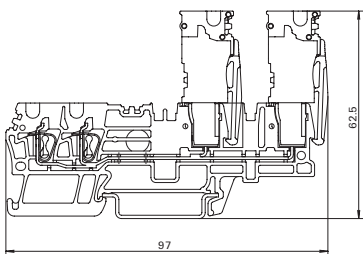
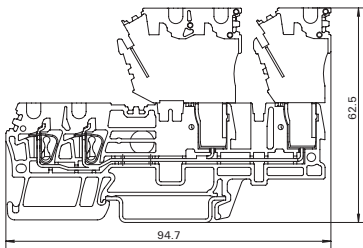
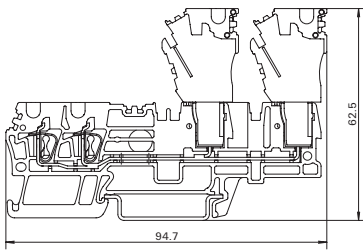
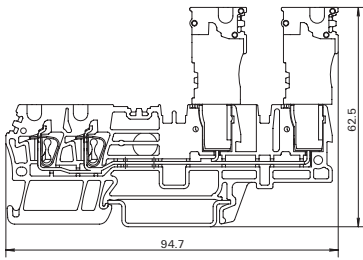

ZTD 2.5/2

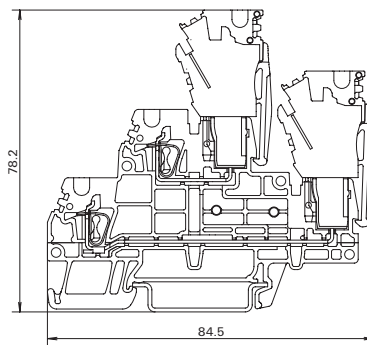
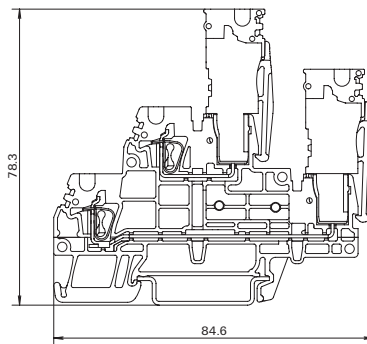
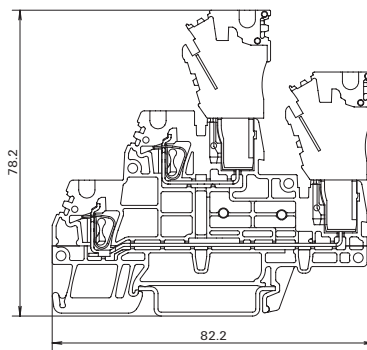
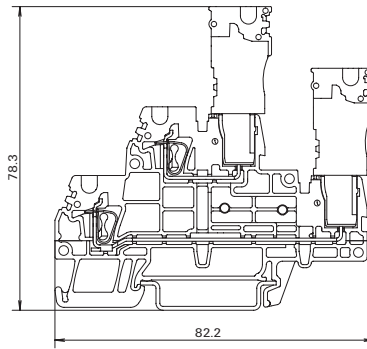

ZT 2.5/4AN/4

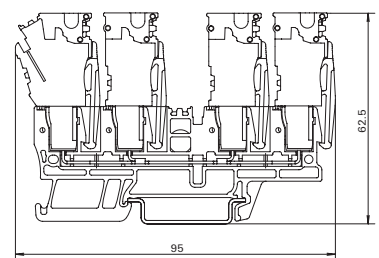
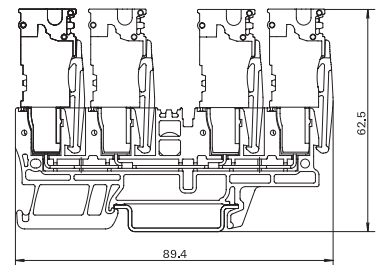
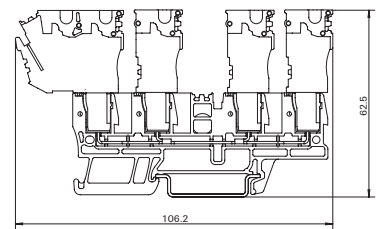
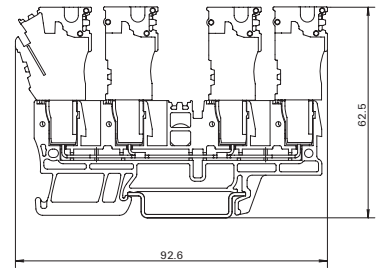
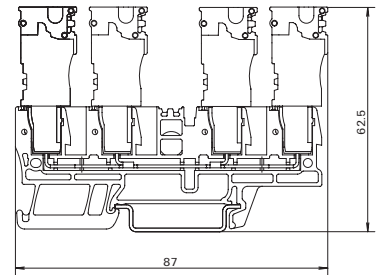

A modular distribution system with proven tension-clamp connections

Distribution terminal bars from stackable single modules, consisting of carrier and base elements

The basis for this modular system is the side-by-side mounting of the individual modules of the distribution terminals with their integral cross-connection. The female contact is on one side, the male contact on the other. Thanks to the modular thin-element design, variable distribution strips can be set up to suit the application. The base elements, which are clipped onto TS 35 terminal rails, form the supports for these module combinations. These base elements are available in a number of different versions:

- Carrier elements with and without signal lines for 3- and 4-wire connections
- Modular construction which enables individual configuration

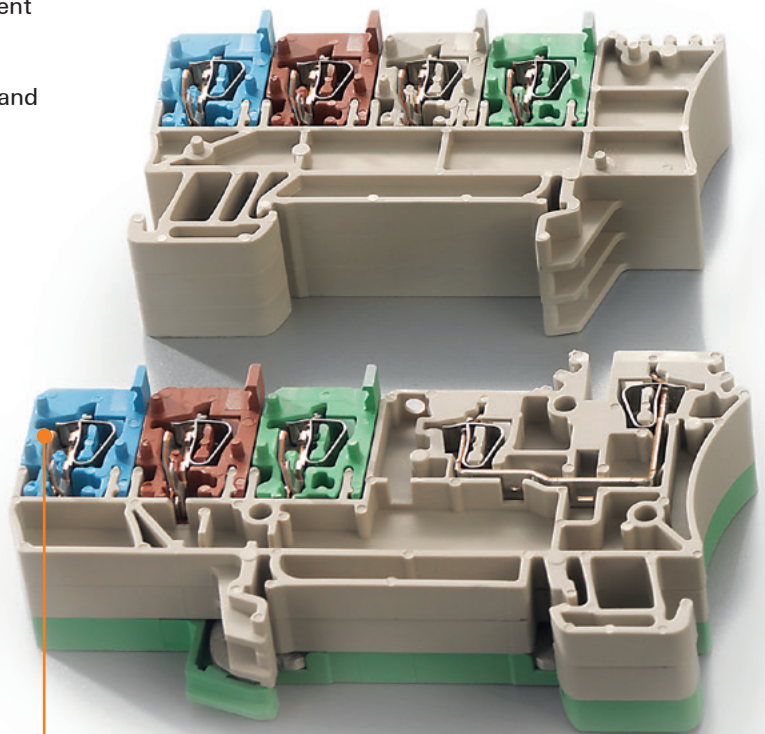

Simple operation

The distribution terminals with integrated cross-connections can be joined together and be snapped into the base elements by hand.

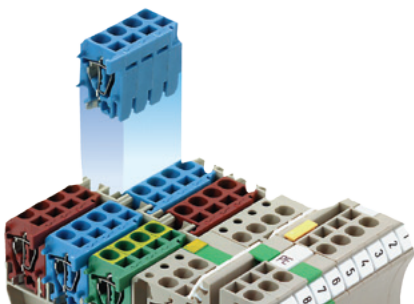

Integrated cross-connection

Potential distribution with integrated cross-connections of the male and female contacts.

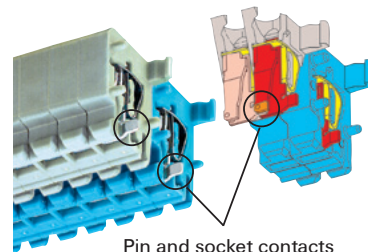

Pin and socket contacts

Modular system

Variable number of poles available on account of their simple connection or separation capabilities.

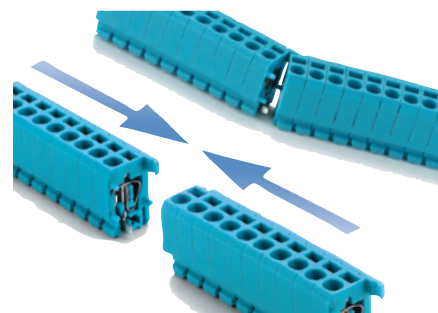

For initiators and actuators

The modular distribution strip system is a convenient way to supply initiators and actuators with three- or four-wire power connections.

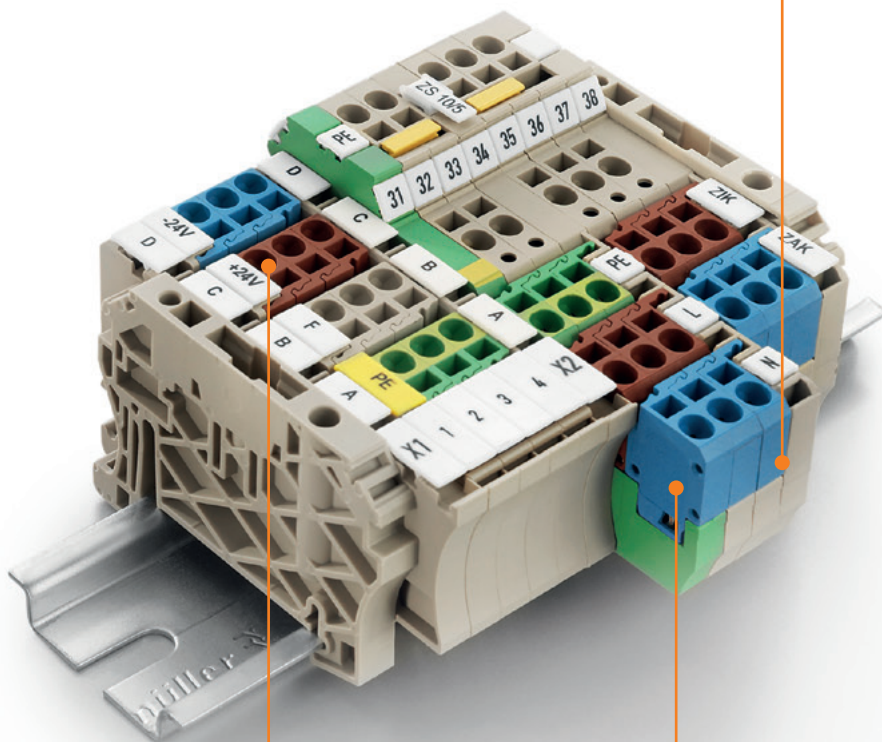
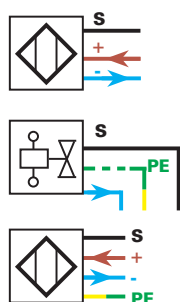

Initiator and actuator terminals

The modular distribution strip system

In hazardous area applications, the installation instructions and the rated data specifications for accessories given in the technical appendix must be followed.

Width/Length/Height of lowest version	mm
max. current / max. cond. cross-section	A/mm ²
Max. clamping range	mm ²

Technical data

Rated data	
Rated voltage	V
Max. voltage of clamp support & pluggable system	V
Rated current	A
Rated cross-section	mm ²
Rated impulse withstand voltage / Pollution severity	
Gauge to IEC 60947-1 / Flammability class UL94	
Approvals	
Clamped conductors (H05V/H07V)	
Solid / stranded	mm ²
Flexible / Flexible with ferrule	mm ²
Stripping length / Blade size	mm/-
Note	

Ordering data

Base terminal	
Base terminal	
Base terminal with LED	
PE base terminal	
Dark beige Wemid	
Blue Wemid	
Brown Wemid	
Dark beige Wemid	
green/yellow Wemid	
Note	

Accessories

Pluggable cross-connection	
	2-pole
	3-pole
	4-pole
	10-pole
	50-pole
Reducing sleeves	
	For conductors < 0.5 mm ² / AWG 20
	For conductors < 1.0 mm ² / AWG 18
End plate / Partition plate	
	Dark beige Wemid
	With assembly peg
	Without peg
Screwdriver	
	Standard

Identification systems	
	(see assortment in catalogue 7)
	Marking tags
Note	

ZPV 1.5 1.5 mm²

Base element

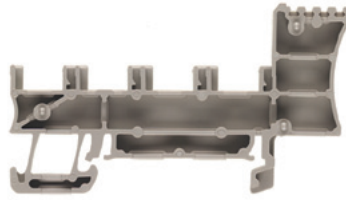

5.1 x 67.8 x 38.35

IEC 60947-7-1		
IEC	UL	CSA
250	300 (D)	
17.5	10 (D)	
1.5	AWG 26...14	AWG 26...14
	4 kV / 3	
	/ V-0	
UL		
Rated connection		

Type	Qty.	Order No.
ZPV 1.5	100	1676630000
ZVL 1.5 0.QV = distribution strip without internal bridge for park position		

Type	current	Qty.	Order No.
Width			
ZAP/TW ZPV1.5	5.08 mm	50	1674650000
SDIS SL 0.6X3.5X100			
		1	1274660000

DEK 5/5 / WS 12/5
For holding the ZVL 1.5 distribution strip

ZIA 1.5/3 L... 1.5 mm²

Base element 3-wire

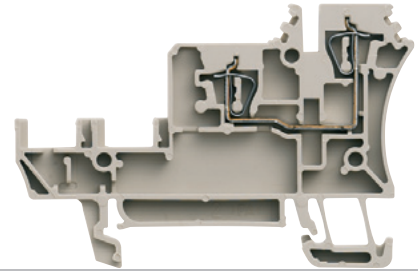

5.08 x 68.5 x 46
/ 2.5
0.13...2.5

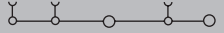

IEC 60947-7-1		
IEC	UL	CSA
250	300 (D)	300 (D)
17.5	10 (D)	10 (D)
1.5	AWG 26...14	AWG 26...14
	4 kV / 3	
	A1 / V-0	
UL		
Rated connection		
0.5...2.5		
0.5...2.5 / 0.5...1.5		
8 / 0.6 x 3.5 mm		
Bi-directional LED in ZIA 1.5/3L-1/LD (1651990000)		

Type	Qty.	Order No.
ZIA 1.5/3L-1S	100	1651980000
ZIA 1.5/3L-1S/LD-RT	50	1651990000
ZIA 1.5/3L-PE	20	1652000000
ZVL 1.5 0.QV = distribution strip without internal bridge for park position		

Type	current	Qty.	Order No.
ZQV 2.5/2	24 A	60	1608860000
ZQV 2.5/3	24 A	60	1608870000
ZQV 2.5/4	24 A	60	1608880000
ZQV 2.5/10	24 A	20	1608940000
ZQV 2.5/50	24 A	10	1697540000
Width			
ZRH 1.5N/1	4.85 mm	1000	1632140000
ZRH 1.5N/2	4.85 mm	1000	1632130000
ZAP/TW ZIA1.5/3L	5.08 mm	50	1649540000
SDIS SL 0.6X3.5X100			
		1	1274660000

DEK 5/5

ZIA 1.5/4 L...

1.5 mm²

Base element 4-wire

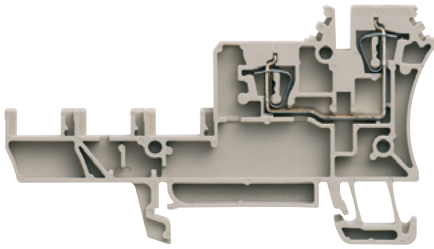

5.08 x 81.5 x 46
/ 2.5
0.13...2.5



IEC 60947-7-1

IEC	UL	CSA
250	300 (D)	
17.5	10 (D)	
1.5	AWG 26...14	AWG 26...14
	4 kV / 3	
	A1 / V-0	



Rated connection

0.5...2.5
0.5...2.5 / 0.5...1.5
8 / 0.6 x 3.5 mm

Bi-directional LED in ZIA 1.5/4L-1/LD (1652020000)

Type	Qty.	Order No.
ZIA 1.5/4L-1S	100	1652010000
ZIA 1.5/4L-1S/LD	50	1652020000
ZIA 1.5/4L-PE	20	1652030000

ZVL 1.5 0.QV = distribution strip without internal bridge for park position

Type	current	Qty.	Order No.
ZQV 2.5/2	24 A	60	1608860000
ZQV 2.5/3	24 A	60	1608870000
ZQV 2.5/4	24 A	60	1608880000
ZQV 2.5/10	24 A	20	1608940000
ZQV 2.5/50	24 A	10	1697540000

Width			
ZRH 1.5N/1	4.85 mm	1000	1632140000
ZRH 1.5N/2	4.85 mm	1000	1632130000
ZAP/TW ZIA1.5/4L	5.08 mm	50	1649550000
SDIS SL 0.6X3.5X100		1	1274660000

DEK 5/5

ZVL 1.5

1.5 mm²

Distribution strip



5.08 x 12.9 x 17.45
/ 2.5
0.13...2.5



IEC 60947-7-1

IEC	UL	CSA
250	300 (D)	300 (D)
17.5	10 (D)	10 (D)
1.5	AWG 26...14	AWG 26...14
	4 kV / 3	
	A2 / V-0	



Rated connection

0.5...2.5
0.5...2.5 / 0.5...1.5
7 / 0.6 x 3.5 mm

Type	Qty.	Order No.
ZVL 1.5	100	1649300000
ZVL 1.5 BL	100	1650360000
ZVL 1.5 BR	100	1650370000
ZVL 1.5 0.QV	100	1711930000
ZVL 1.5/PE GN/GE BED	100	1651970000

ZVL 1.5 0.QV = distribution strip without internal bridge for park position

Type	current	Qty.	Order No.
ZRH 1.5N/1	4.85 mm	1000	1632140000
ZRH 1.5N/2	4.85 mm	1000	1632130000

Width			
BZT ZVL1.5	5 mm	100	1676610000
BZT ZVL1.5/0.ZA	5 mm	100	1676620000
SDIS SL 0.6X3.5X100		1	1274660000

DEK 5/5

Integrated cross-connectors.
Distribution strip for base element ZPV 1.5 Order no. 1676630000

Modular design

This mini-terminal family in tension clamp technology can be used to assemble individual blocks with 2- and 4-pole terminals.

An individual colour scheme for individual connection groups allows visual differentiation between different circuits.

With a structural width of only 5 mm (2 connections) or 10 mm (4 connections), the TOP connection system guarantees clearly organised wiring of circuits, even in terminal boxes with restricted space.

There are three different marking options for quick and clear identification of each terminal.

Made of Weidmüller's top quality WEMID insulation, all block terminals comply with requirements for a V0 flammability class to UL94.

C

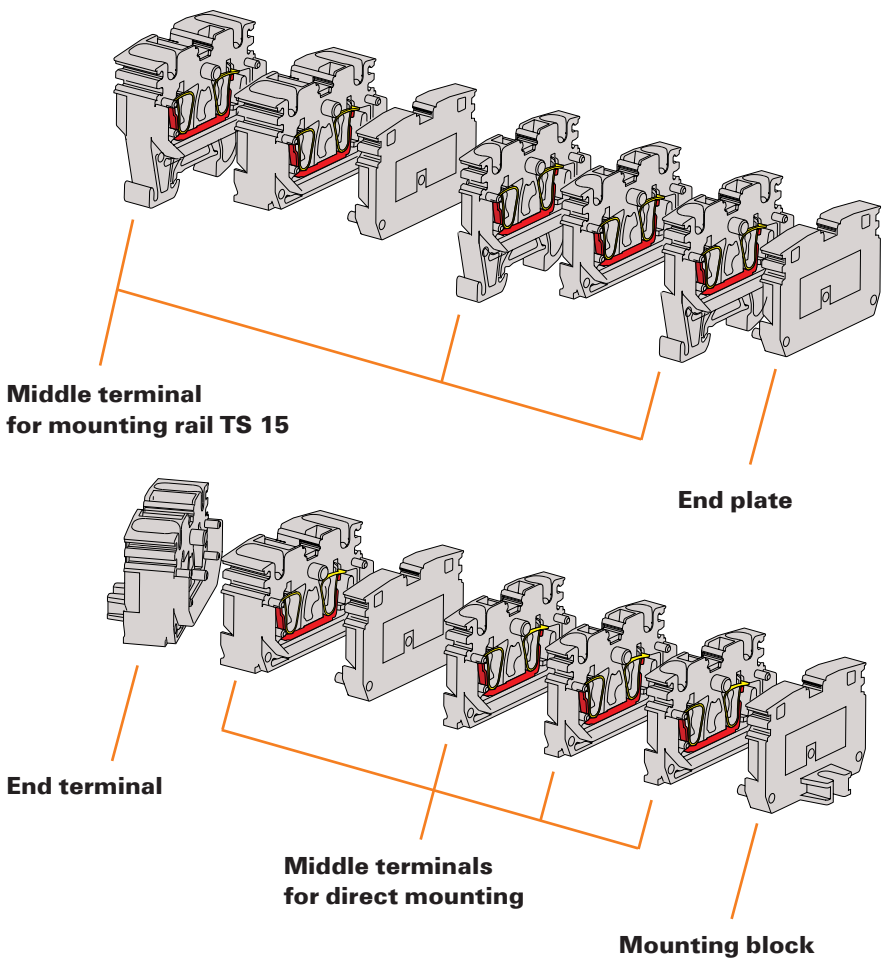

Individual blocks are put together from **middle terminals** and an end plate for the open side. Screw fastening involves the first middle terminal and the **end plate** being replaced by end terminals for fastening purposes. With the other fastening variations, **middle terminals with means of fastening** are integrated within the block or a **mounting foot (MOFU)** is used for fitting to the mounting rail.

... with 4 different means of fastening

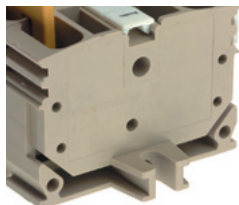

Direct mounting with screw fastening on mounting plate

The fastening terminals on the right and left of the terminal block are mounted using M3 screws. Central fastening is not possible in this case.

ZDUB 2.5-2 DM

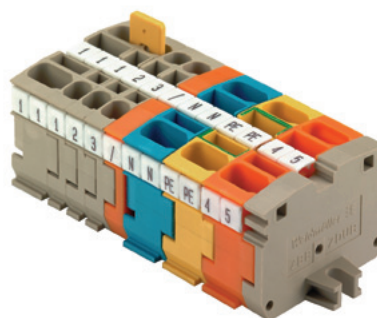

Clip-on fastening on mounting plates

The terminals are simply clipped onto mounting plates 0.6 – 1.2 mm thick with the clips in the 3.5 mm holes. The open side of the terminal is closed by an end plate.

ZDUB 2.5-2 RC

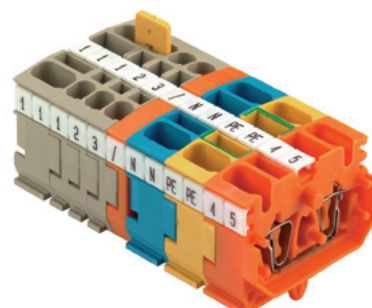

**Drilling plan:
ZDUB/2.5-2/2AN**

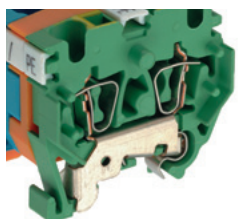
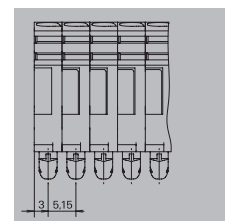

Fitting on mounting rail TS 15

For clipping on mounting rail TS 15. The open side of the terminal is closed by an end plate.

ZPEB 2.5-2 TS 15

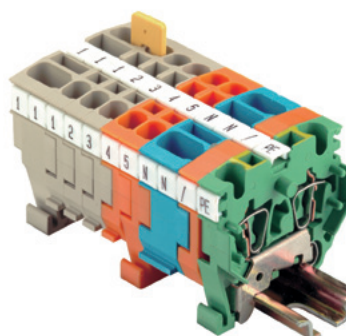

ZDUB 2.5-2/4AN

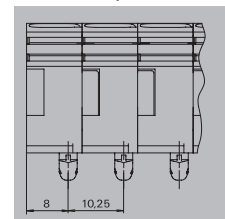

Mounting foot for mounting rail TS 15/35

The mounting foot can be used for clipping terminal blocks consisting only of middle terminals either to TS 15 or TS 35 mounting rails.

MOFU TS 15/35

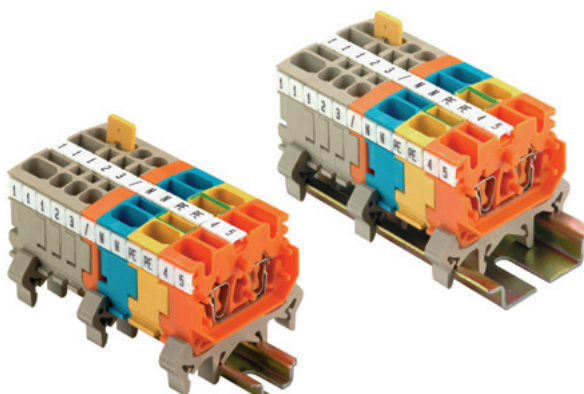

Mini terminals

Terminal blocks for different fixing systems

In hazardous area applications, the installation instructions and the rated data specifications for accessories given in the technical appendix must be followed.

Width/Length/Height of lowest version	mm
max. current / max. cond. cross-section	A/mm ²
Max. clamping range	mm ²

Technical data

Rated data	
Rated voltage	V
Rated current	A
Rated cross-section	mm ²
Rated impulse withstand voltage / Pollution severity	Gauge to IEC 60947-1 / Flammability class UL94
Approvals	
Clamped conductors (H05V/H07V)	
Solid / stranded	mm ²
Flexible / Flexible with ferrule	mm ²
Stripping length / Blade size	mm/-
Note	

Ordering data

Central terminals	
	Dark beige Wemid
	Blue Wemid
	Yellow Wemid
	Orange Wemid
Note	

Accessories

Pluggable cross-connection	2-pole
	
End plate / Partition plate	
	Dark beige Wemid
	Blue Wemid
	Orange PA
Screwdriver	Standard

Identification systems	(see assortment in catalogue 7)
	Marking tags
Note	



ZDUB 2.5-2/2AN/RC

2.5 mm²

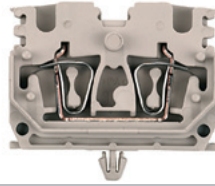
Two connections



5.1 x 33.2 x 29
30 / 4
0.13...4

IEC 60947-7-1	Ex e II		II 2 G D
IEC	UL	CSA	EN 60079-7
800	600 (C)	600 (C)	550
24	20 (C)	25 (C)	21
2.5	AWG 26...12	AWG 26...12	2.5
8 kV / 3			
A2 / V-0			
 KEMA 97ATEX2755 U			
Rated connection			
0.5...4			
0.5...2.5 / 0.5...1.5			
10 / 0.6 x 3.5 mm			
Snap-on clip			

Type	Qty.	Order No.
ZDUB 2.5-2/2AN/RC	100	1712820000
ZDUB 2.5-2/2AN/RC BL	100	1712830000
ZDUB 2.5-2/2AN/RC GE	100	1712850000
ZDUB 2.5-2/2AN/RC OR	100	1712840000
Diameter of the snap-on clip mounting holes is 3.5 mm when the thickness of the plate is 0.6-961.2 mm.		

Type	current	Qty.	Order No.
ZQB 2.5-2	24 A	50	1677120000
Width			
ZAP ZDUB	5 mm	50	1704750000
ZAP ZDUB BL	5 mm	50	1704760000
ZAP ZDUB OR	5 mm	50	1704770000
SDIS SL 0.6X3.5X100		1	1274660000

DEK 5/5 / WS 10/5
The terminal blocks are cross-connected when using the ZQB 2.5 (1677120000).



ZDUB 2.5-2/4AN/RC

2.5 mm²

Four connections



10.2 x 33.5 x 29
30 / 4
0.13...4

IEC 60947-7-1	Ex e II		II 2 G D
IEC	UL	CSA	EN 60079-7
800	600 (C)	600 (C)	550
24	20 (C)	25 (C)	21
2.5	AWG 26...12	AWG 26...12	2.5
8 kV / 3			
A2 / V-0			
 KEMA 97ATEX2755 U			
Rated connection			
0.5...4			
0.5...2.5 / 0.5...1.5			
10 / 0.6 x 3.5 mm			
Snap-on clip			

Type	Qty.	Order No.
ZDUB 2.5-2/4AN/RC	100	1712970000
ZDUB 2.5-2/4AN/RC BL	100	1712980000
ZDUB 2.5-2/4AN/RC GE	100	1713000000
Diameter of the snap-on clip mounting holes is 3.5 mm when the thickness of the plate is 0.6-961.2 mm.		

Type	current	Qty.	Order No.
ZQB 2.5-2	24 A	50	1677120000
Width			
ZAP ZDUB	5 mm	50	1704750000
ZAP ZDUB BL	5 mm	50	1704760000
ZAP ZDUB OR	5 mm	50	1704770000
SDIS SL 0.6X3.5X100		1	1274660000

DEK 5/5 / WS 10/5
The terminal blocks are cross-connected when using the ZQB 2.5 (1677120000).

Terminal blocks for different fixing systems

In hazardous area applications, the installation instructions and the rated data specifications for accessories given in the technical appendix must be followed.

Width/Length/Height of lowest version	mm
max. current / max. cond. cross-section	A/mm ²
Max. clamping range	mm ²

Technical data

Rated data	
Rated voltage	V
Rated current	A
Rated cross-section	mm ²
Rated impulse withstand voltage / Pollution severity	
Gauge to IEC 60947-1 / Flammability class UL94	
Approvals	
Clamped conductors (H05V/H07V)	
Solid / stranded	mm ²
Flexible / Flexible with ferrule	mm ²
Stripping length / Blade size	mm/-
Note	

Ordering data

End terminals	
Dark beige Wemid	
Blue Wemid	
Yellow Wemid	
Central terminals	
Dark beige Wemid	
Blue Wemid	
Yellow Wemid	
Orange Wemid	
Note	

Accessories

Pluggable cross-connection	
	2-pole
End plate / Partition plate	
Dark beige Wemid	
Blue Wemid	
Orange PA	
Mounting blocks	
Dark beige Wemid	
Screwdriver	
Standard	
Mounting foot for TS15 & TS35	
Dark beige Wemid	

Identification systems	
(see assortment in catalogue 7)	
Marking tags	
Note	



ZDUB 2.5-2/2AN/DM

2.5 mm²

Two connections



5.1 x 33.5 x 24
30 / 4
0.13...4

IEC 60947-7-1	Ex e II		II 2 G D
IEC	UL	CSA	EN 60079-7
800	600 (C)	600 (C)	550
24	20 (C)	25 (C)	21
2.5	AWG 26...12	AWG 26...12	2.5...
8 kV / 3			
A2 / V-0			
 KEMA 97ATEX2755 U			
Rated connection			
0.5...4			
0.5...2.5 / 0.5...1.5			
10 / 0.6 x 3.5 mm			
Direct mounting			

Type	Qty.	Order No.
ZDUB 2.5-2/2AN/DB	100	1704500000
ZDUB 2.5-2/2AN/DB BL	100	1704510000
ZDUB 2.5-2/2AN/DB GE	100	1704530000
ZDUB 2.5-2/2AN/DM	100	1704350000
ZDUB 2.5-2/2AN/DM BL	100	1704360000
ZDUB 2.5-2/2AN/DM GE	100	1704380000
ZDUB 2.5-2/2AN/DM OR	100	1704370000

Type	current	Qty.	Order No.
ZQB 2.5-2	24 A	50	1677120000
Width			
ZAP ZDUB	5 mm	50	1704750000
ZAP ZDUB BL	5 mm	50	1704760000
ZAP ZDUB OR	5 mm	50	1704770000
ZBB ZDUB	5.1 mm	50	1704740000
SDIS SL 0.6X3.5X100		1	1274660000
MOFU 15/35 ZDUB	5 mm	50	1723660000

Identification systems	
(see assortment in catalogue 7)	
Marking tags	
Note	
DEK 5/5 / WS 10/5	
The terminal blocks are cross-connected when using the ZQB 2.5 (1677120000).	



ZDUB 2.5-2/4AN/DM

2.5 mm²

Four connections



10.2 x 33.5 x 24
30 / 4
0.13...4

IEC 60947-7-1	Ex e II		II 2 G D
IEC	UL	CSA	EN 60079-7
800	600 (C)	600 (C)	550
24	20 (C)	25 (C)	21
2.5	AWG 26...12	AWG 26...12	2.5...
8 kV / 3			
A2 / V-0			
 KEMA 97ATEX2755 U			
Rated connection			
0.5...4			
0.5...2.5 / 0.5...1.5			
10 / 0.6 x 3.5 mm			
Direct mounting			

Type	Qty.	Order No.
ZDUB 2.5-2/4AN/DB	100	1704690000
ZDUB 2.5-2/4AN/DB BL	100	1704700000
ZDUB 2.5-2/4AN/DB GE	100	1704720000
ZDUB 2.5-2/4AN/DM	100	1704540000
ZDUB 2.5-2/4AN/DM BL	100	1704550000
ZDUB 2.5-2/4AN/DM GE	100	1704570000
ZDUB 2.5-2/4AN/DM OR	100	1704560000

Type	current	Qty.	Order No.
ZQB 2.5-2	24 A	50	1677120000
Width			
ZAP ZDUB	5 mm	50	1704750000
ZAP ZDUB BL	5 mm	50	1704760000
ZAP ZDUB OR	5 mm	50	1704770000
ZBB ZDUB	5.1 mm	50	1704740000
SDIS SL 0.6X3.5X100		1	1274660000
MOFU 15/35 ZDUB	5 mm	50	1723660000

Identification systems	
(see assortment in catalogue 7)	
Marking tags	
Note	
DEK 5/5 / WS 10/5	
The terminal blocks are cross-connected when using the ZQB 2.5 (1677120000).	

Mini terminals

Terminal blocks for different fixing systems

In hazardous area applications, the installation instructions and the rated data specifications for accessories given in the technical appendix must be followed.

Width/Length/Height of lowest version	mm
max. current / max. cond. cross-section	A/mm ²
Max. clamping range	mm ²

Technical data

Rated data	
Rated voltage	V
Rated current	A
Rated cross-section	mm ²
Rated impulse withstand voltage / Pollution severity	
Gauge to IEC 60947-1 / Flammability class UL94	
Approvals	
Clamped conductors (H05V/H07V)	
Solid / stranded	mm ²
Flexible / Flexible with ferrule	mm ²
Stripping length / Blade size	mm/-
Note	

Ordering data

Central terminals	
	Dark beige Wemid
	Blue Wemid
	Green/Yellow Wemid
	Orange Wemid
Note	

Accessories

Pluggable cross-connection	
	2-pole
	3-pole
	4-pole
	10-pole
	50-pole
End plate / Partition plate	
	Dark beige Wemid
	Blue Wemid
	Orange PA
Screwdriver	
	Standard
End bracket	

Identification systems	(see assortment in catalogue 7)
	Marking tags
Note	

ZDUB 2.5-2/2AN/TS15

2.5 mm²

Two connections



5.1 x 33.5 x 32	
30 / 4	
0.13...4	

IEC 60947-7-1	Ex e II	Ex	II 2 G D
IEC	UL	CSA	EN 60079-7
800	600 (C)	600 (C)	550
24	20 (C)	25 (C)	21
2.5	AWG 26...12	AWG 26...12	2.5
8 kV / 3			
A2 / V-0			
KEMA 97ATEX2755 U			
Rated connection			
0.5...4			
0.5...2.5 / 0.5...1.5			
10 / 0.6 x 3.5 mm			
TS 15 - block construction			

Type	Qty.	Order No.
ZDUB 2.5-2/2AN/15	100	1712750000
ZDUB 2.5-2/2AN/15 BL	100	1712760000
ZDUB 2.5-2/2AN/15 OR	100	1712770000

Type	current	Qty.	Order No.
ZQB 2.5-2	24 A	50	1677120000
Width			
ZAP ZDUB	5 mm	50	1704750000
ZAP ZDUB BL	5 mm	50	1704760000
ZAP ZDUB OR	5 mm	50	1704770000
SDIS SL 0.6X3.5X100		1	1274660000
ZEW 15	5 mm	20	7920340000

Identification systems	(see assortment in catalogue 7)
	Marking tags
Note	

DEK 5/5 / WS 10/5
The terminal blocks are cross-connected when using the ZQB 2.5 (1677120000).

ZDUB 2.5-2/4AN/TS15

2.5 mm²

Four connections



10.2 x 33.5 x 32	
30 / 4	
0.13...4	

IEC 60947-7-1	Ex e II	Ex	II 2 G D
IEC	UL	CSA	EN 60079-7
800	600 (C)	600 (C)	550
24	20 (C)	25 (C)	21
2.5	AWG 26...12	AWG 26...12	2.5
8 kV / 3			
A2 / V-0			
KEMA 97ATEX2755 U			
Rated connection			
0.5...4			
0.5...2.5 / 0.5...1.5			
10 / 0.6 x 3.5 mm			
TS 15 - block construction			

Type	Qty.	Order No.
ZDUB 2.5-2/4AN/15	100	1712780000
ZDUB 2.5-2/4AN/15 BL	100	1712790000
ZDUB 2.5-2/4AN/15 OR	100	1712800000

Type	current	Qty.	Order No.
ZQB 2.5-2	24 A	50	1677120000
Width			
ZAP ZDUB	5 mm	50	1704750000
ZAP ZDUB BL	5 mm	50	1704760000
ZAP ZDUB OR	5 mm	50	1704770000
SDIS SL 0.6X3.5X100		1	1274660000
ZEW 15	5 mm	20	7920340000

Identification systems	(see assortment in catalogue 7)
	Marking tags
Note	

DEK 5/5 / WS 10/5
The terminal blocks are cross-connected when using the ZQB 2.5 (1677120000).

ZPEB 2.5-2

2.5 mm²

Two connections



5.1 x 33.5 x 32
/ 4
0.13...4

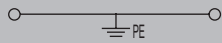

IEC 60947-7-2

Ex e II II 2 G D

IEC	UL	CSA	EN 60079-7
24			
2.5	AWG 26...12	AWG 26...12	2.5
8 kV / 3			
A2 / V-0			

KEMA 97ATEX2755 U

Rated connection
0.5...4
0.5...2.5 / 0.5...1.5
10 / 0.6 x 3.5 mm

TS 15 - block construction

Type	Qty.	Order No.
ZPEB 2.5-2	100	1712810000

Type	current	Qty.	Order No.
Width			
ZAP ZDUB	5 mm	50	1704750000
Width			
SDIS SL 0.6X3.5X100		1	1274660000
ZEW 15	5 mm	20	7920340000

DEK 5/5 / WS 10/5

ZDUA 2.5-2

2.5 mm²

Two connections



5.1 x 35 x 30.5
30 / 4
0.13...4

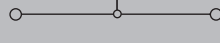

IEC 60947-7-1

Ex e II II 2 G D

IEC	UL	CSA	EN 60079-7
500	600 (C)	600 (B)	275
24	20 (C)	20 (B)	20
2.5	AWG 22...12	AWG 26...12	2.5
6 kV / 3			
A2 / V-0			

KEMA 97ATEX4678 U

Rated connection
0.5...4
0.5...2.5 / 0.5...1.5
10 / 0.6 x 3.5 mm

TS 15 - sliced construction

Type	Qty.	Order No.
ZDUA 2.5-2	100	1720920000
ZDUA 2.5-2 BL	100	1720930000
ZDUA 2.5-2 OR	100	1720940000

Type	current	Qty.	Order No.
ZQV 2.5N/2 GE	24 A	60	1693800000
ZQV 2.5N/3 GE	24 A	60	1693810000
ZQV 2.5N/4 GE	24 A	60	1693820000
ZQV 2.5N/10 GE	24 A	20	1693880000
ZQV 2.5N/50 GE	24 A	5	1693890000
Width			
ZAP/TW ZDUA	1.5 mm	50	1720960000
ZAP/TW ZDUA BL	1.5 mm	50	1720970000
ZAP/TW ZDUA OR	1.5 mm	50	1720980000
Width			
SDIS SL 0.6X3.5X100		1	1274660000
ZEW 15	5 mm	20	7920340000

DEK 5/5 / WS 10/5

ZPEA 2.5-2

2.5 mm²

Two connections



5.1 x 35 x 30.5
/ 4
0.13...4

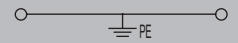

IEC 60947-7-2

Ex e II II 2 G D

IEC	UL	CSA	EN 60079-7
24			
2.5	AWG 26...12	AWG 26...12	2.5
6 kV / 3			
A2 / V-0			

KEMA 97ATEX4678 U

Rated connection
0.5...4
0.5...2.5 / 0.5...1.5
10 / 0.6 x 3.5 mm

TS 15 - sliced construction

Type	Qty.	Order No.
ZPEA 2.5-2	100	1720950000

Type	current	Qty.	Order No.
Width			
ZAP/TW ZDUA	1.5 mm	50	1720960000
Width			
SDIS SL 0.6X3.5X100		1	1274660000
ZEW 15	5 mm	20	7920340000

DEK 5/5 / WS 10/5

Mini terminals

Terminal blocks for different fixing systems

In hazardous area applications, the installation instructions and the rated data specifications for accessories given in the technical appendix must be followed.

Width/Length/Height of lowest version	mm
max. current / max. cond. cross-section	A/mm ²
Max. clamping range	mm ²

Technical data

Rated data	
Rated voltage	V
Rated current	A
Rated cross-section	mm ²
Rated impulse withstand voltage / Pollution severity Gauge to IEC 60947-1 / Flammability class UL94	
Approvals	
Clamped conductors (H05V/H07V)	
Solid / stranded	mm ²
Flexible / Flexible with ferrule	mm ²
Stripping length / Blade size	mm/-
Note	

Ordering data

Central terminals	
	Dark beige Wemid
	Blue Wemid
	Green/Yellow Wemid
	Orange Wemid
Note	

Accessories

Pluggable cross-connection	
	2-pole
	3-pole
	4-pole
	10-pole
	50-pole
End plate / Partition plate	
	Dark beige Wemid
	Blue Wemid
	Orange PA
Screwdriver	
	Standard
End bracket	

Identification systems	
	(see assortment in catalogue 7)
	Marking tags
Note	

ZDUA 2.5-2N

2.5 mm²

Two connections



5.1 x 42.5 x 35.5	
30 / 4	
0.13...4	

IEC 60947-7-1

IEC	UL	CSA
800	600 (C)	600 (C)
24	20 (C)	20 (C)
2.5	AWG 26...12	AWG 26...12
8 kV / 3		
A2 / V-0		
Rated connection		
0.5...4		
0.5...2.5 / 0.5...1.5		
10 / 0.6 x 3.5 mm		
TS 15 - sliced construction		

Type	Qty.	Order No.
ZDUA 2.5-2N	100	1808200000
ZDUA 2.5-2N BL	100	1808180000

Type	current	Qty.	Order No.
ZQV 2.5N/2 GE	24 A	60	1693800000
ZQV 2.5N/3 GE	24 A	60	1693810000
ZQV 2.5N/4 GE	24 A	60	1693820000
ZQV 2.5N/10 GE	24 A	20	1693880000
ZQV 2.5N/50 GE	24 A	5	1693890000
Width			
ZAP/TW ZDUA2.5-2N	2.5 mm	50	1808170000
SDIS SL 0.6X3.5X100			
		1	1274660000
ZEW 15			
	5 mm	20	7920340000

Identification systems	
	DEK 5/5 / WS 10/5
Note	

ZPEA 2.5-2N

2.5 mm²

Two connections

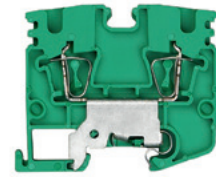

5.1 x 42.5 x 35.5	
/ 4	
0.13...4	

IEC 60947-7-2

IEC	UL	CSA
800	600 (C)	600 (C)
24	20 (C)	20 (C)
2.5	AWG 26...12	AWG 26...12
8 kV / 3		
A2 / V-0		
Rated connection		
0.5...4		
0.5...2.5 / 0.5...1.5		
10 / 0.6 x 3.5 mm		
TS 15 - sliced construction		

Type	Qty.	Order No.
ZPEA 2.5-2N	100	1808210000

Type	current	Qty.	Order No.
ZQV 2.5N/2 GE	24 A	60	1693800000
ZQV 2.5N/3 GE	24 A	60	1693810000
ZQV 2.5N/4 GE	24 A	60	1693820000
ZQV 2.5N/10 GE	24 A	20	1693880000
ZQV 2.5N/50 GE	24 A	5	1693890000
Width			
ZAP/TW ZDUA2.5-2N	2.5 mm	50	1808170000
SDIS SL 0.6X3.5X100			
		1	1274660000
ZEW 15			
	5 mm	20	7920340000

Identification systems	
	DEK 5/5 / WS 10/5
Note	

Terminals with electronic components

Z-series standard ranges provide solutions for conductor cross-sections from 0.05 to 35 mm².

In hazardous area applications, the installation instructions and the rated data specifications for accessories given in the technical appendix must be followed.

Width/Length/Height of lowest version	mm
max. current / max. cond. cross-section	A/mm ²
Max. clamping range	mm ²

Technical data

Rated data	
Rated voltage	V
Rated current	A
Rated cross-section	mm ²
Rated impulse withstand voltage / Pollution severity Gauge to IEC 60947-1 / Flammability class UL94	
Approvals	
Electronic fixtures	
Component voltage / Component current	V/A
Operating voltage for display, max. / Current	V/A
Clamped conductors (H05V/H07V)	
Solid / stranded	mm ²
Flexible / Flexible with ferrule	mm ²
Stripping length / Blade size	mm/-
Note	

Ordering data

Version	
	Dark beige Wemid
	Dark beige Wemid (red LED)
	Orange
Note	

Accessories

Pluggable cross-connection	
	2-pole
	3-pole
	4-pole
	10-pole
	20-/24-pole
End plate / Partition plate	
	Blue Wemid
	Dark beige Wemid
End bracket	
	Dark beige Wemid
Test adapter	
	With assembly peg
Screwdriver	
	Standard
Reducing sleeves	
	For conductors < 0.5 mm ² / AWG 20
	For conductors < 1.0 mm ² / AWG 18

Identification systems	(see assortment in catalogue 7)
	Marking tags
Note	

ZDU 2.5/2x2AN/LD+

2.5 mm²

LED indicator

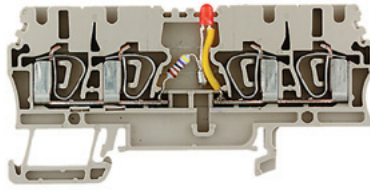

5.1 x 79.5 x 39.5
/ 4
0.05...4



IEC 60947-7-1

IEC	UL	CSA
24		
0.05		
2.5		
	6 kV / 3	
	A3 / V-0	
24 / 0.05		
Rated connection		
0.5...4		
0.5...4 / 0.5...2.5		
10 / 0.6 x 3.5 mm		

Type	Qty.	Order No.
ZDU 2.5/2X2AN/LD+	20	1692590000

Type	current	Qty.	Order No.
Width			
ZAP/TW 3	2 mm	50	1608800000
ZEW 35	6 mm	20	9540000000
SDIS SL 0.6X3.5X100		1	1274660000
ZRH 2.5/1 WS	5.55 mm	1000	1614300000
ZRH 2.5/2 GR/V0	5.55 mm	1000	1614290000

DEK 5/5 / WS 10/5	
Note	

ZDU 2.5/2x2AN/LD-

2.5 mm²

LED indicator

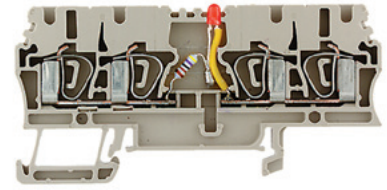

5.1 x 79.5 x 39.5
/ 4
0.05...4



IEC 60947-7-1

IEC	UL	CSA
24		
0.05		
2.5		
	6 kV / 3	
	A3 / V-0	
24 / 0.05		
Rated connection		
0.5...4		
0.5...4 / 0.5...2.5		
10 / 0.6 x 3.5 mm		

Type	Qty.	Order No.
ZDU 2.5/2X2AN/LD-	20	1692600000

Type	current	Qty.	Order No.
Width			
ZAP/TW 3	2 mm	50	1608800000
ZEW 35	6 mm	20	9540000000
SDIS SL 0.6X3.5X100		1	1274660000
ZRH 2.5/1 WS	5.55 mm	1000	1614300000
ZRH 2.5/2 GR/V0	5.55 mm	1000	1614290000

DEK 5/5 / WS 10/5	
Note	

ZDU 2.5/2x2AN/D+

2.5 mm²

Diode circuit

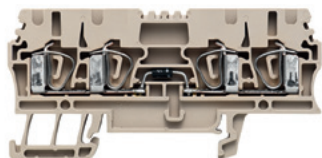

5.1 x 79.5 x 39.5
/ 4
0.5...4

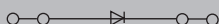

IEC 60947-7-1

IEC	UL	CSA
400		
1		
2.5		
6 kV / 3 A3 / V-0		
1000 / 1		

Rated connection

0.5...4
0.5...4 / 0.5...2.5
10 / 0.6 x 3.5 mm

Type	Qty.	Order No.
ZDU 2.5/2X2AN/D+	20	1650340000

Soldered in diode: type 1N 4007, cut-off voltage 1000 V, current 1 A.

Type	current	Qty.	Order No.
Width			
ZAP/TW 3	2 mm	50	1608800000
ZEW 35	6 mm	20	9540000000
Width			
SDIS SL 0.6X3.5X100		1	1274660000
ZRH 2.5/1 WS	5.55 mm	1000	1614300000
ZRH 2.5/2 GR/V0	5.55 mm	1000	1614290000

DEK 5/5 / WS 10/5

ZDU 2.5/2x2AN/D-

2.5 mm²

Diode circuit

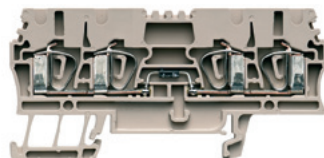

5.1 x 79.5 x 39.5
/ 4
0.5...4



IEC 60947-7-1

IEC	UL	CSA
400		
1		
2.5		
6 kV / 3 A3 / V-0		
1000 / 1		

Rated connection

0.5...4
0.5...4 / 0.5...2.5
10 / 0.6 x 3.5 mm

Type	Qty.	Order No.
ZDU 2.5/2X2AN/D-	20	1650350000

Soldered in diode: type 1N 4007, cut-off voltage 1000 V, current 1 A.

Type	current	Qty.	Order No.
Width			
ZAP/TW 3	2 mm	50	1608800000
ZEW 35	6 mm	20	9540000000
Width			
SDIS SL 0.6X3.5X100		1	1274660000
ZRH 2.5/1 WS	5.55 mm	1000	1614300000
ZRH 2.5/2 GR/V0	5.55 mm	1000	1614290000

DEK 5/5 / WS 10/5

Terminals with electronic components

Z-series standard ranges provide solutions for conductor cross-sections from 0.05 to 35 mm².

In hazardous area applications, the installation instructions and the rated data specifications for accessories given in the technical appendix must be followed.

Width/Length/Height of lowest version	mm
max. current / max. cond. cross-section	A/mm ²
Max. clamping range	mm ²

Technical data

Rated data	
Rated voltage	V
Rated current	A
Rated cross-section	mm ²
Rated impulse withstand voltage / Pollution severity	
Gauge to IEC 60947-1 / Flammability class UL94	
Approvals	
Electronic fixtures	
Component voltage / Component current	V/A
Operating voltage for display, max. / Current	V/A
Clamped conductors (H05V/H07V)	
Solid / stranded	mm ²
Flexible / Flexible with ferrule	mm ²
Stripping length / Blade size	mm/-
Note	

Ordering data

Version	
	Dark beige Wemid
	Dark beige Wemid (red LED)
	Orange
Note	

Accessories

Pluggable cross-connection	
	2-pole
	3-pole
	4-pole
	10-pole
	20-/24-pole
End plate / Partition plate	
	Blue Wemid
	Dark beige Wemid
End bracket	
	Dark beige Wemid
Test adapter	
	With assembly peg
Screwdriver	
	Standard
Reducing sleeves	
	For conductors < 0.5 mm ² / AWG 20
	For conductors < 1.0 mm ² / AWG 18

Identification systems	
	(see assortment in catalogue 7)
	Marking tags
Note	

ZDU 2.5-2/D+

2.5 mm²

Diode circuit

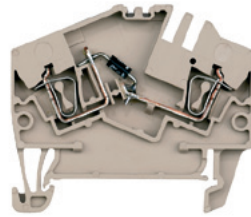

5.1 x 50.5 x 44	
/ 2.5	
0.05...2.5	

IEC 60947-7-1

IEC	UL	CSA
400	600 (C)	600 (C)
1	1 (C)	1 (C)
2.5	AWG 26...12	AWG 26...12
6 kV / 3		
A2 / V-0		



1000 / 1

Rated connection

0.5...2.5
0.5...2.5 / 0.5...1.5
10 / 0.6 x 3.5 mm

2.5 mm² flexible wires with wire-end ferrules are crimped with the Weidmüller PZ 6/5 crimping tool.

Type	Qty.	Order No.
ZDU 2.5-2/D+	20	1779110000
Soldered in diode: type 1N 4007, cut-off voltage 1000 V, current 1 A.		

ZDU 2.5-2/D-

2.5 mm²

Diode circuit

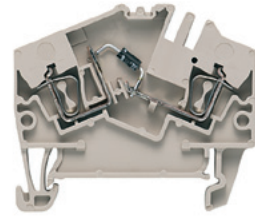

5.1 x 50.5 x 44	
/ 2.5	
0.05...2.5	

IEC 60947-7-1

IEC	UL	CSA
400	600 (C)	600 (C)
1	1 (C)	1 (C)
2.5	AWG 26...12	AWG 26...12
6 kV / 3		
A2 / V-0		



1000 / 1

Rated connection

0.5...2.5
0.5...2.5 / 0.5...1.5
10 / 0.6 x 3.5 mm

2.5 mm² flexible wires with wire-end ferrules are crimped with the Weidmüller PZ 6/5 crimping tool.

Type	Qty.	Order No.
ZDU 2.5-2/D-	20	1779000000
Soldered in diode: type 1N 4007, cut-off voltage 1000 V, current 1 A.		

Type	current	Qty.	Order No.
ZQV 2.5/2	24 A	60	1608860000
ZQV 2.5/3	24 A	60	1608870000
ZQV 2.5/4	24 A	60	1608880000
ZQV 2.5/10	24 A	20	1608940000
ZQV 2.5/20	24 A	20	1908960000
Width			
ZAP/TW7	2.5 mm	50	1706110000
ZEW 35	6 mm	20	9540000000
SDIS SL 0.6X3.5X100			
		1	1274660000
ZRH 1.5H/1	4.85 mm	1000	1678810000
ZRH 1.5H/2	4.85 mm	1000	1678800000

Type	current	Qty.	Order No.
ZQV 2.5/2	24 A	60	1608860000
ZQV 2.5/3	24 A	60	1608870000
ZQV 2.5/4	24 A	60	1608880000
ZQV 2.5/10	24 A	20	1608940000
ZQV 2.5/20	24 A	20	1908960000
Width			
ZAP/TW7	2.5 mm	50	1706110000
ZEW 35	6 mm	20	9540000000
SDIS SL 0.6X3.5X100			
		1	1274660000
ZRH 1.5H/1	4.85 mm	1000	1678810000
ZRH 1.5H/2	4.85 mm	1000	1678800000

Identification systems	
	(see assortment in catalogue 7)
	Marking tags
	DEK 5/5 / WS 14/5
Note	

Identification systems	
	(see assortment in catalogue 7)
	Marking tags
	DEK 5/5 / WS 14/5
Note	

ZDK 2.5 EM

2.5 mm²

Double-level terminal

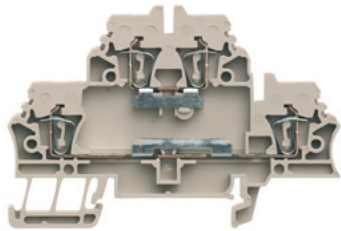

5.1 x 79.5 x 54
20 / 2.5
0.05...2.5

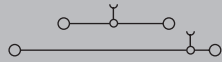

IEC 60947-7-1

Ex e II II 2 G D

IEC	UL	CSA	EN 60079-7
500	300 (C)	300 (C)	275
20	15 (C)	25 (C)	18
2.5	AWG 26...14	AWG 26...12	2.5

6 kV / 3

A2 / V-0



KEMA 97ATEX4677 U

Rated connection

0.5...2.5
0.5...2.5 / 0.5...2.5
10 / 0.6 x 3.5 mm

2.5 mm² flexible wires with wire-end ferrules are crimped with the Weidmüller PZ 6/5 crimping tool.

Type	Qty.	Order No.
ZDK 2.5 EM	50	1768800000
ZDK 2.5 OR	50	1694140000

Empty electronics enclosure for do-it-yourself soldering of components.

Type	current	Qty.	Order No.
ZQV 2.5/2	24 A	60	1608860000
ZQV 2.5/3	24 A	60	1608870000
ZQV 2.5/4	24 A	60	1608880000
ZQV 2.5/10	24 A	20	1608940000
ZQV 2.5/20	24 A	20	1908960000
Width			
ZAP/TW ZDK2.5 BL	1.5 mm	20	1748800000
ZAP/TW ZDK2.5	1.5 mm	20	1674730000
ZEW 35	6 mm	20	9540000000
ZTA 4	5.1 mm	25	1688110000
SDIS SL 0.6X3.5X100		1	1274660000
ZRH 1.5H/1	4.85 mm	1000	1678810000
ZRH 1.5H/2	4.85 mm	1000	1678800000

DEK 5/5 / WS 12/5

ZQV 2.5/15 (1720700000) connects two busbars, one above the other.

ZDK 2.5/LD RT/1

2.5 mm²

LED circuit

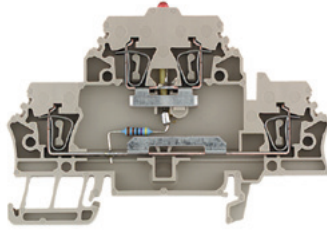

5.1 x 79.1 x 54
/ 2.5
0.05...2.5

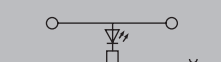

IEC 60947-7-1

IEC	UL	CSA
24		
10		
2.5	AWG 26...14	AWG 26...12

/ 3

A2 / V-0



24 / 0.05

Rated connection

0.5...2.5
0.5...2.5 / 0.5...1.5
10 / 0.6 x 3.5 mm

2.5 mm² flexible conductors with wire-end ferrules are crimped with the Weidmüller PZ 6/5 crimping tool.

Type	Qty.	Order No.
ZDK 2.5/LD RT/1	50	1690010000

Voltage on the continuous busbar = 10 A.

Type	current	Qty.	Order No.
ZQV 2.5/2	24 A	60	1608860000
ZQV 2.5/3	24 A	60	1608870000
ZQV 2.5/4	24 A	60	1608880000
ZQV 2.5/10	24 A	20	1608940000
ZQV 2.5/20	24 A	20	1908960000
Width			
ZAP/TW ZDK2.5	1.5 mm	20	1674730000
ZEW 35	6 mm	20	9540000000
SDIS SL 0.6X3.5X100		1	1274660000
ZRH 1.5H/1	4.85 mm	1000	1678810000
ZRH 1.5H/2	4.85 mm	1000	1678800000

DEK 5/5 / WS 10/5

ZDK 2.5/LD RT/2

2.5 mm²

LED circuit

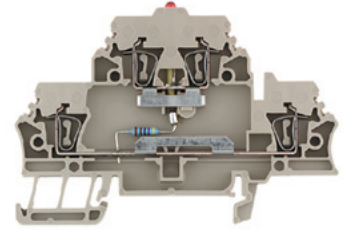

5.1 x 79.1 x 54
/ 2.5
0.05...2.5



IEC 60947-7-1

IEC	UL	CSA
24		
10		
2.5	AWG 26...14	AWG 26...12

/ 3

A2 / V-0



24 / 0.05

Rated connection

0.5...2.5
0.5...2.5 / 0.5...1.5
10 / 0.6 x 3.5 mm

2.5 mm² flexible conductors with wire-end ferrules are crimped with the Weidmüller PZ 6/5 crimping tool.

Type	Qty.	Order No.
ZDK 2.5/LD RT/2	50	1693940000

Voltage on the continuous busbar = 10 A.

Type	current	Qty.	Order No.
ZQV 2.5/2	24 A	60	1608860000
ZQV 2.5/3	24 A	60	1608870000
ZQV 2.5/4	24 A	60	1608880000
ZQV 2.5/10	24 A	20	1608940000
ZQV 2.5/20	24 A	20	1908960000
Width			
ZAP/TW ZDK2.5	1.5 mm	20	1674730000
ZEW 35	6 mm	20	9540000000
SDIS SL 0.6X3.5X100		1	1274660000
ZRH 1.5H/1	4.85 mm	1000	1678810000
ZRH 1.5H/2	4.85 mm	1000	1678800000

DEK 5/5 / WS 10/5

Terminals with electronic components

Z-series standard ranges provide solutions for conductor cross-sections from 0.05 to 35 mm².

In hazardous area applications, the installation instructions and the rated data specifications for accessories given in the technical appendix must be followed.

Width/Length/Height of lowest version	mm
max. current / max. cond. cross-section	A/mm ²
Max. clamping range	mm ²

Technical data

Rated data	
Rated voltage	V
Rated current	A
Rated cross-section	mm ²
Rated impulse withstand voltage / Pollution severity	
Gauge to IEC 60947-1 / Flammability class UL94	
Approvals	
Electronic fixtures	
Component voltage / Component current	V/A
Operating voltage for display, max. / Current	V/A
Clamped conductors (H05V/H07V)	
Solid / stranded	mm ²
Flexible / Flexible with ferrule	mm ²
Stripping length / Blade size	mm/-
Note	

Ordering data

Version	
	Dark beige Wemid
	Dark beige Wemid (red LED)
	Orange
Note	

Accessories

Pluggable cross-connection	
	2-pole
	3-pole
	4-pole
	10-pole
	20-/24-pole
End plate / Partition plate	
	Blue Wemid
	Dark beige Wemid
End bracket	
	Dark beige Wemid
Test adapter	
	With assembly peg
Screwdriver	
	Standard
Reducing sleeves	
	For conductors < 0.5 mm ² / AWG 20
	For conductors < 1.0 mm ² / AWG 18

Identification systems	
	(see assortment in catalogue 7)
	Marking tags
Note	

ZDK 2.5/D/1

2.5 mm²

Diode circuit

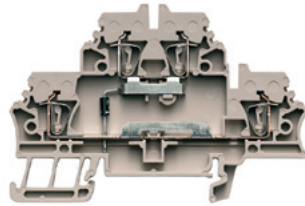

5.1 x 79.1 x 54	
/ 2.5	
0.05...2.5	

IEC 60947-7-1

IEC	UL	CSA
500	300 (C)	300 (D)
10	15 (C)	10 (D)
2.5	AWG 26...14	AWG 26...12
6 kV / 3		
A2 / V-0		

1000 / 1

Rated connection

0.5...2.5
0.5...2.5 / 0.5...1.5
4 / 0.6 x 3.5 mm

2.5 mm² flexible wires with wire-end ferrules are crimped with the Weidmüller PZ 6/5 crimping tool.

Type	Qty.	Order No.
ZDK 2.5/D/1	50	1690020000

Soldered diode: Type 1N 4007, reverse voltage 1000 V, current 1 A; current of continuous current bar = 10 A.

Type	current	Qty.	Order No.
ZQV 2.5/2	24 A	60	1608860000
ZQV 2.5/3	24 A	60	1608870000
ZQV 2.5/4	24 A	60	1608880000
ZQV 2.5/10	24 A	20	1608940000
ZQV 2.5/20	24 A	20	1908960000
Width			
ZAP/TW ZDK2.5	1.5 mm	20	1674730000
ZEW 35	6 mm	20	9540000000
SDIS SL 0.6X3.5X100			
		1	1274660000
ZRH 1.5H/1	4.85 mm	1000	1678810000
ZRH 1.5H/2	4.85 mm	1000	1678800000

Identification systems	
	(see assortment in catalogue 7)
	Marking tags
Note	

DEK 5/5 / WS 10/5

ZDK 2.5/D/2

2.5 mm²

Diode circuit

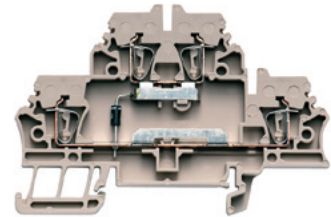

5.1 x 79.1 x 54	
/ 2.5	
0.05...2.5	

IEC 60947-7-1

IEC	UL	CSA
500	300 (C)	300 (D)
10	15 (C)	10 (D)
2.5	AWG 26...14	AWG 26...12
6 kV / 3		
A2 / V-0		

1000 / 1

Rated connection

0.5...2.5
0.5...2.5 / 0.5...1.5
10 / 0.6 x 3.5 mm

2.5 mm² flexible wires with wire-end ferrules are crimped with the Weidmüller PZ 6/5 crimping tool.

Type	Qty.	Order No.
ZDK 2.5/D/2	50	1690030000

Soldered diode: Type 1N 4007, reverse voltage 1000 V, current 1 A; current of continuous current bar = 10 A.

Type	current	Qty.	Order No.
ZQV 2.5/2	24 A	60	1608860000
ZQV 2.5/3	24 A	60	1608870000
ZQV 2.5/4	24 A	60	1608880000
ZQV 2.5/10	24 A	20	1608940000
ZQV 2.5/20	24 A	20	1908960000
Width			
ZAP/TW ZDK2.5	1.5 mm	20	1674730000
ZEW 35	6 mm	20	9540000000
SDIS SL 0.6X3.5X100			
		1	1274660000
ZRH 1.5H/1	4.85 mm	1000	1678810000
ZRH 1.5H/2	4.85 mm	1000	1678800000

Identification systems	
	(see assortment in catalogue 7)
	Marking tags
Note	

DEK 5/5 / WS 10/5

ZDK 2.5/D/4

2.5 mm²

Diode circuit

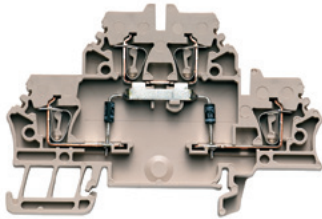

5.1 x 79.1 x 54
/ 2.5
0.05...2.5

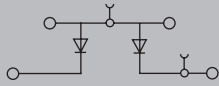

IEC 60947-7-1

IEC	UL	CSA
500	300 (C)	300 (D)
10	15 (C)	10 (D)
2.5	AWG 26...14	AWG 26...12
6 kV / 3		
A2 / V-0		



1000 / 1

Rated connection

0.5...2.5
0.5...2.5 / 0.5...1.5
10 / 0.6 x 3.5 mm

2.5 mm² flexible wires with wire-end ferrules are crimped with the Weidmüller PZ 6/5 crimping tool.

Type	Qty.	Order No.
ZDK 2.5/D/4	50	1690040000

Soldered diode: Type 1N 4007, reverse voltage 1000 V, current 1 A; current of continuous current bar = 10 A.

Type	current	Qty.	Order No.
ZQV 2.5/2	24 A	60	1608860000
ZQV 2.5/3	24 A	60	1608870000
ZQV 2.5/4	24 A	60	1608880000
ZQV 2.5/10	24 A	20	1608940000
ZQV 2.5/20	24 A	20	1908960000
Width			
ZAP/TW ZDK2.5	1.5 mm	20	1674730000
ZEW 35	6 mm	20	9540000000
SDIS SL 0.6X3.5X100		1	1274660000
ZRH 1.5H/1	4.85 mm	1000	1678810000
ZRH 1.5H/2	4.85 mm	1000	1678800000

DEK 5/5 / WS 10/5

ZDK 2.5/D/5

2.5 mm²

Diode circuit

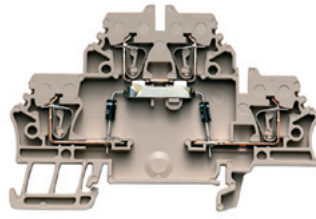

5.1 x 79.1 x 54
/ 2.5
0.05...2.5

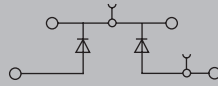

IEC 60947-7-1

IEC	UL	CSA
500	300 (C)	300 (D)
10	15 (C)	10 (D)
2.5	AWG 26...14	AWG 26...12
6 kV / 3		
A2 / V-0		



1000 / 1

Rated connection

0.5...2.5
0.5...2.5 / 0.5...1.5
10 / 0.6 x 3.5 mm

2.5 mm² flexible wires with wire-end ferrules are crimped with the Weidmüller PZ 6/5 crimping tool.

Type	Qty.	Order No.
ZDK 2.5/D/5	50	1690050000

Soldered diode: Type 1N 4007, reverse voltage 1000 V, current 1 A; current of continuous current bar = 10 A.

Type	current	Qty.	Order No.
ZQV 2.5/2	24 A	60	1608860000
ZQV 2.5/3	24 A	60	1608870000
ZQV 2.5/4	24 A	60	1608880000
ZQV 2.5/10	24 A	20	1608940000
ZQV 2.5/20	24 A	20	1908960000
Width			
ZAP/TW ZDK2.5	1.5 mm	20	1674730000
ZEW 35	6 mm	20	9540000000
SDIS SL 0.6X3.5X100		1	1274660000
ZRH 1.5H/1	4.85 mm	1000	1678810000
ZRH 1.5H/2	4.85 mm	1000	1678800000

DEK 5/5 / WS 10/5

ZDK 2.5/D/6

2.5 mm²

Diode circuit

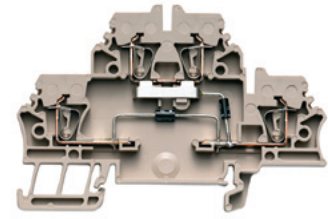

5.1 x 79.1 x 54
/ 2.5
0.05...2.5

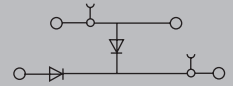

IEC 60947-7-1

IEC	UL	CSA
500	300 (C)	300 (D)
10	15 (C)	10 (D)
2.5	AWG 26...14	AWG 26...12
6 kV / 3		
A2 / V-0		



1000 / 1

Rated connection

0.5...2.5
0.5...2.5 / 0.5...1.5
10 / 0.6 x 3.5 mm

2.5 mm² flexible wires with wire-end ferrules are crimped with the Weidmüller PZ 6/5 crimping tool.

Type	Qty.	Order No.
ZDK 2.5/D/6	50	1690060000

Soldered diode: Type 1N 4007, reverse voltage 1000 V, current 1 A; current of continuous current bar = 10 A.

Type	current	Qty.	Order No.
ZQV 2.5/2	24 A	60	1608860000
ZQV 2.5/3	24 A	60	1608870000
ZQV 2.5/4	24 A	60	1608880000
ZQV 2.5/10	24 A	20	1608940000
ZQV 2.5/20	24 A	20	1908960000
Width			
ZAP/TW ZDK2.5	1.5 mm	20	1674730000
ZEW 35	6 mm	20	9540000000
SDIS SL 0.6X3.5X100		1	1274660000
ZRH 1.5H/1	4.85 mm	1000	1678810000
ZRH 1.5H/2	4.85 mm	1000	1678800000

DEK 5/5 / WS 10/5

Terminals with electronic components

In hazardous area applications, the installation instructions and the rated data specifications for accessories given in the technical appendix must be followed.

Width/Length/Height of lowest version	mm
max. current / max. cond. cross-section	A/mm ²
Max. clamping range	mm ²

Technical data

Rated data	
Rated voltage	V
Rated current	A
Rated cross-section	mm ²
Rated impulse withstand voltage / Pollution severity Gauge to IEC 60947-1 / Flammability class UL94	
Approvals	
Electronic fixtures	
Component voltage / Component current	V/A
Operating voltage for display, max. / Current	V/A
Clamped conductors (H05V/H07V)	
Solid / stranded	mm ²
Flexible / Flexible with ferrule	mm ²
Stripping length / Blade size	mm/-
Note	

Ordering data

Version	
Dark beige Wemid	
Dark beige Wemid (red LED)	
Orange	
Note	

Accessories

Pluggable cross-connection	
2-pole	
3-pole	
4-pole	
10-pole	
20-/24-pole	
End plate / Partition plate	
Blue Wemid	
Dark beige Wemid	
End bracket	
Dark beige Wemid	
Test adapter	
With assembly peg	
Screwdriver	
Standard	
Reducing sleeves	
For conductors < 0.5 mm ² / AWG 20	
For conductors < 1.0 mm ² / AWG 18	

Identification systems	
(see assortment in catalogue 7)	
Marking tags	
Note	

ZDK 4-2 EL

4 mm²

Double-level terminal

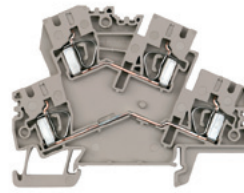

6.1 x 77.6 x 61	
32 / 6	
0.13...6	

IEC 60947-7-1

IEC	UL	CSA
800	600 (C)	
32	25 (C)	
4	AWG 26...10	
8 kV / 3		
A3 / V-0		

1000 / 1		

Rated connection	
0.5...6	
0.5...4 / 0.5...4	
10 / 0.6 x 3.5 mm	

Type	Qty.	Order No.
ZDK 4-2 EL	50	8709760000

Type	current	Qty.	Order No.
ZQV 4/2 GE	32 A	60	1608950000
ZQV 4/3 GE	32 A	60	1608960000
ZQV 4/4 GE	32 A	60	1608970000
ZQV 4/10 GE	32 A	20	1609030000
Width			
ZAP/TW ZDK4-2 BL	2 mm	50	8670620000
ZAP/TW ZDK4-2	2 mm	50	8670760000
ZEW 35	6 mm	20	9540000000
ZTA 6/ZA	6.1 mm	25	1780660000
SDIS SL 0.6X3.5X100		1	1274660000

Identification systems	
(see assortment in catalogue 7)	
Note	

ZDK 4-2/D forward

4 mm²

Diode circuit



6.1 x 77.6 x 60.5	
/ 6	
0.13...6	

IEC 60947-7-1

IEC	UL	CSA
800	600 (C)	600 (C)
1	1 (C)	1 (C)
4	AWG 26...10	AWG 26...10
8 kV / 3		
A3 / V-0		

1000 / 1		

Rated connection	
0.5...6 / 1.5...4	
0.5...4 / 0.5...4	
10 / 0.6 x 3.5 mm	

Type	Qty.	Order No.
ZDK 4-2/D forward	50	8670520000

Soldered diode: Type 1N 4007, reverse voltage 1000 V, current 1 A; current of continuous current bar = 10 A.

Type	current	Qty.	Order No.
ZQV 4/2 GE	32 A	60	1608950000
ZQV 4/3 GE	32 A	60	1608960000
ZQV 4/4 GE	32 A	60	1608970000
ZQV 4/10 GE	32 A	20	1609030000
ZQV 4/20 GE	32 A	20	1909010000
Width			
ZAP/TW ZDK4-2	2 mm	50	8670760000
ZEW 35	6 mm	20	9540000000
SDIS SL 0.6X3.5X100		1	1274660000

Identification systems	
(see assortment in catalogue 7)	
Marking tags	
Note	
DEK 5/6	

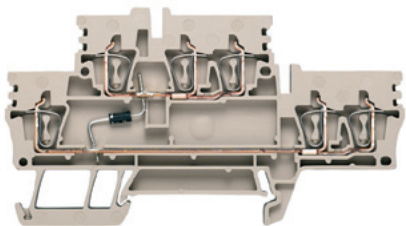
ZDK 2.5/3AN D2**4 mm²****Diode circuit**

5.1 x 93 x 51.5
/ 4
0.05...4

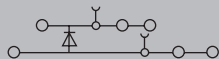

IEC 60947-7-1

IEC	UL	CSA
500	300 (C)	300 (C)
1	20 (C)	24 (C)
4	AWG 30...12	AWG 30...12
6 kV / 3		
A2 / V-0		



1000 / 1

Rated connection

0.5...4 / 1.5...2.5

0.5...2.5 / 0.21...2.5

10 / 0.6 x 3.5 mm

2.5 mm² flexible wires with wire-end ferrules are crimped with the Weidmüller PZ 6/5 crimping tool.

Type	Qty.	Order No.
ZDK 2.5/3AN D2	50	1924450000
Soldered diode: Type 1N 4007, reverse voltage 1000 V, current 1 A; current of continuous current bar = 10 A.		

Type	current	Qty.	Order No.
ZQV 2.5/2	24 A	60	1608860000
ZQV 2.5/3	24 A	60	1608870000
ZQV 2.5/4	24 A	60	1608880000
ZQV 2.5/10	24 A	20	1608940000
ZQV 2.5/20	24 A	20	1908960000
Width			
ZAP/TW ZDK 2.5/3AN	1.5 mm	20	1924910000
ZEW 35/2	8 mm	20	8630740000
SDIS SL 0.6X3.5X100			
		1	1274660000
ZRH 1.5H/1	4.85 mm	1000	1678810000
ZRH 1.5H/2	4.85 mm	1000	1678800000

DEK 5/5 / WS 10/5

2.5 mm² wires with wire ferrules including the plastic collar only clampable with diameter-optimised collar (Order no. 1333100000, pack of 500).

Extra functions

C

Extra functions

Weidmüller offers the user of Z-Series terminals a comprehensive range of accessories, providing optimum solutions to every conceivable task – even outside the range of standard uses. All Weidmüller accessories are built to the same high standards as the terminals themselves.

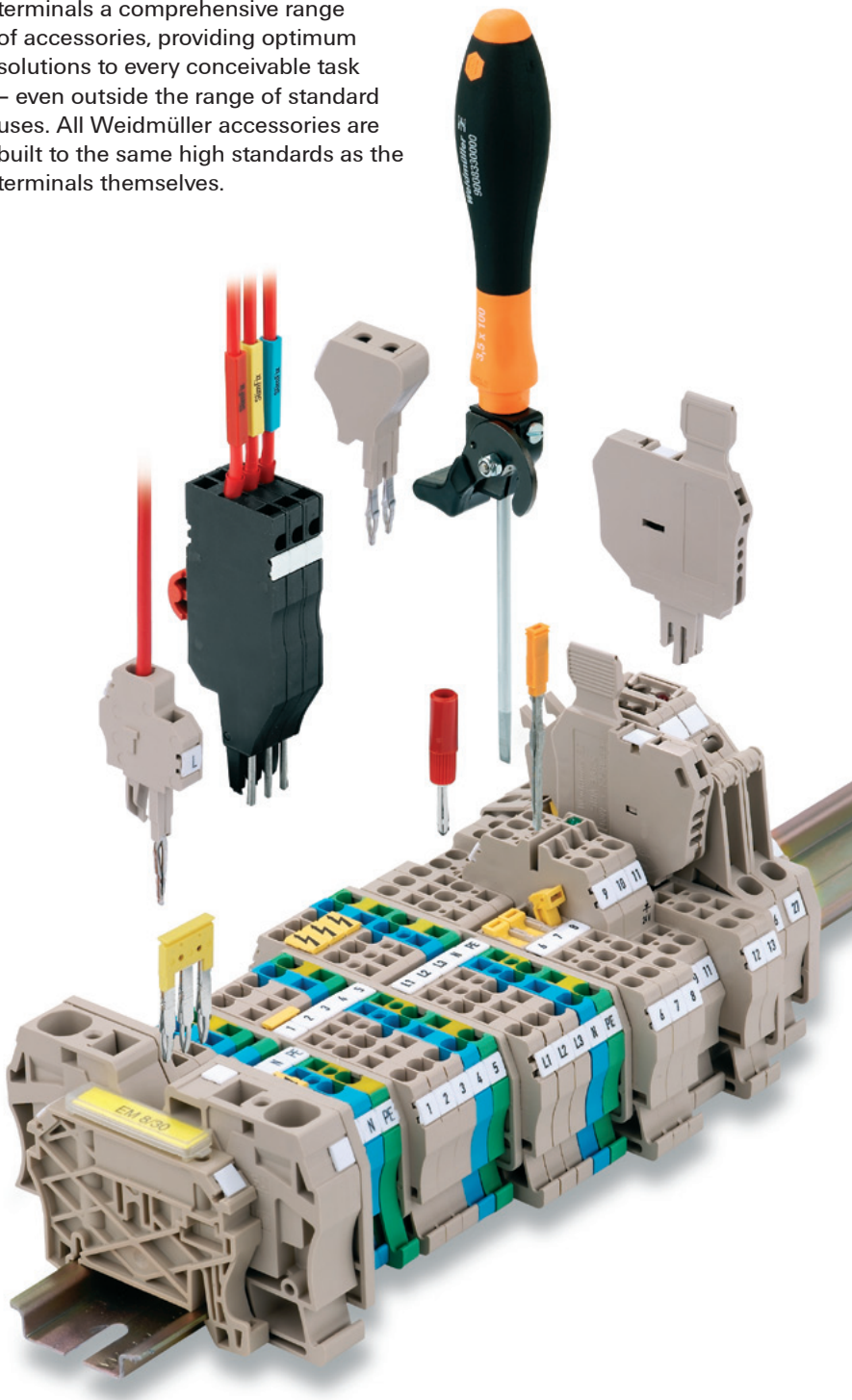

Visual separation

Page C.130

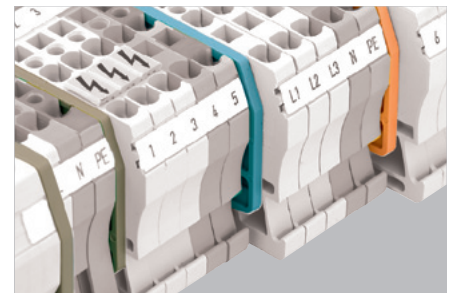

To guarantee “finger-safe” use of terminals, the open sides are covered with end cover plates and partition plates to prevent any contact with conducting parts. End cover plates and partition plates also come in different colours so that they can be used for visual separation of different circuits.

Pluggable terminals

Page C.100

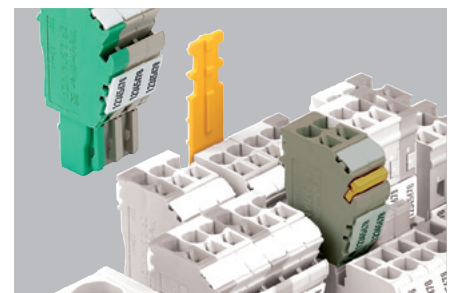

WeiCoS

Weidmüller Connection System

This new generation of pluggable terminals is structured on the modular principle. The basic elements of the WeiCoS system are one terminal for the functional unit on the mounting rail and a plug-in connector for elements to be connected (cable harness production).

Fastening

Chapter F

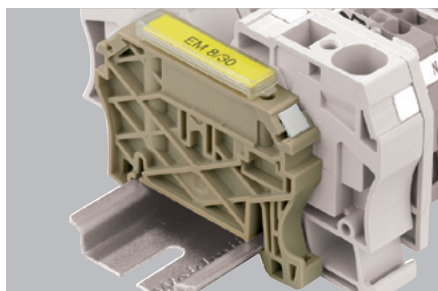

An end bracket is fitted on the mounting rail to the right and left of the terminals to ensure that they sit firmly in position.

The marking surface of the end bracket can also be used for group marking. Details of the wide range of Weidmüller end brackets and mounting rails are given in **chapter F**.

Electrical supply

Page C.134

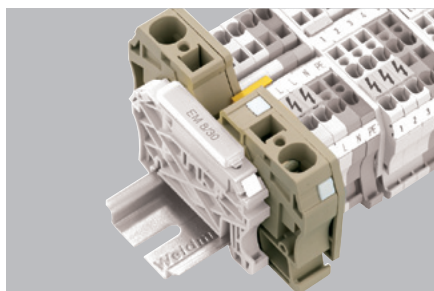

Weidmüller's tension clamp terminals have three supply terminals: ZEI 16 for standard terminals, ZEI 16-2/1 AN for Roof-Style terminals, ZEI 6 for ZDU 1.5

Cross-connections divide the supply current into several feeder currents. Current is supplied across a conductor cross-section of 16 mm² and then distributed across neighbouring terminals for 1.5 mm², 2.5 mm², 4 mm² and 6 mm² cross-sectional areas.

Electrical distribution

Page C.136



A plug-in **cross-connection system (ZQV)** is available for all Z-Series terminals.

The current is distributed across any number of terminals by simply plugging the cross-connection into the middle of the terminals. As a rule, 400 V can be transmitted across the cross-section, depending on the rated voltage of the terminal.

Testing / checking

Page C.142

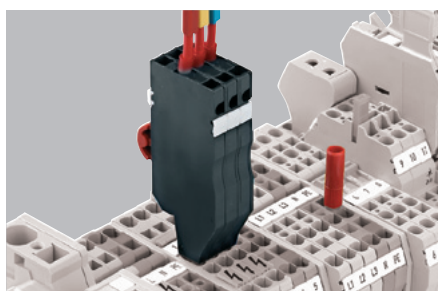

The slot-in test adapter (ZTA) is used as a single unit and as a test adapter strip for voltage measurement in control cabinets. The test adapter is ideal for convenient, rational testing of assembled terminals. It is simply slotted onto the terminal. This creates contact with the current carrying busbar. The unit is released from the terminal simply by pressing the release button.

Identification and connecting

Page C.146



Weidmüller's identification systems in **chapter F** are used to mark tension clamp terminals. Individual terminals, terminal groups and conductors can be marked. The conductors are connected in the tension clamp terminals with standard screwdrivers, as shown in **chapter F**. As an alternative to screwdrivers, fully insulated operating tools are also available; see page D.146.

Specific functions/ colour variations

Page C.152

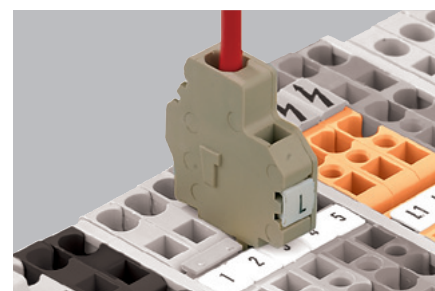

Further helpful accessories are available for terminals using tension clamp technology, such as:

- Pluggable extra connections (ZZA)
- Housings for installation of electronic components (ZBS 1)
- Pluggable fuse holder (SIHA 1 to SIHA 3)
- Terminals in various colours.
- Accessories for fuses
- Reducing sleeves

End plates

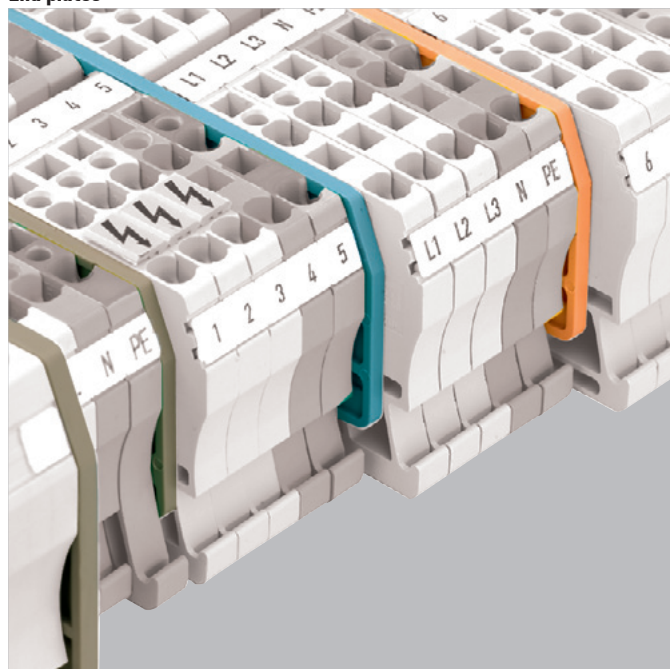

Touch-safe protection

The last terminal in a terminal strip must be closed off with a ZAP/TW-type end plate. End plates must also be used within a terminal strip when it makes use of terminals of different sizes. This ensures that the touch-safe requirement is met for live-voltage components and that the terminals are touch-safe.

Optical separation

Coloured end plates are frequently used for distinguishing the circuits.

Ensuring the operating voltage

End plates can also be used to maintain the required clearance and creepage distances, in order to guarantee the rated voltage for the application. They can be used when cross-connections are used side-by-side.

Contour matching

The overall dimensions of the end plates match the external dimensions of the associated terminal.

Mounting

The end plate's snap-in pegs allow it to be simply fitted on to the corresponding terminal. The corresponding indentations in the terminal are used to ensure that position follows the identical contours.

... for standard terminals

Type	Width	Colour	Qty.	Order No.	For terminal:
ZAP/TW ZDU1.5/2AN	2 mm	beige	20	1776030000	ZDU 1.5
ZAP/TW ZDU1.5/2AN BL	2 mm	blue	20	1776040000	ZDU 1.5 BL
ZAP/TW ZDU1.5/2AN OR	2 mm	orange	20	1776050000	ZPE 1.5
Width 2 mm					
ZAP/TW ZDU1.5/3AN	2 mm	beige	20	1776060000	ZDU 1.5/3 AN
ZAP/TW ZDU1.5/3AN BL	2 mm	blue	20	1776070000	ZDU 1.5/3 AN/BL
ZAP/TW ZDU1.5/3AN OR	2 mm	orange	20	1776080000	ZPE 1.5/3AN
Width 2 mm					
ZAP/TW ZDU1.5/4AN	2 mm	beige	20	1776090000	ZDU 1.5 2X2AN
ZAP/TW ZDU1.5/4AN BL	2 mm	blue	20	1776100000	ZDU 1.5 2X2AN BL
ZAP/TW ZDU1.5/4AN OR	2 mm	orange	20	1776110000	ZDU 1.5/4 AN
					ZDU 1.5/4 AN/BL
					ZPE 1.5/4AN
Width 2 mm					
ZAP/TW ZDK1.5	2 mm	dark beige	20	1791160000	ZDK 1.5
ZAP/TW ZDK1.5 BL	2 mm	blue	20	1791170000	ZDK 1.5 BL
					ZDK 1.5 PE
					ZDK 1.5DU-PE
					ZDK 1.5V
					ZDK 1.5V BL
Width 2 mm					
ZAP/TW 1	2 mm	dark beige	50	1608740000	ZDU 2.5
ZAP/TW 1 BL	2 mm	blue/light blue	50	1608750000	ZDU 2.5 BL
ZAP/TW 1 GN	2 mm	green	50	1683680000	ZPE 2.5
ZAP/TW 1 GR	2 mm	grey	50	1683710000	ZTR 2.5
ZAP/TW 1 OR	2 mm	orange	50	1608760000	ZTR 2.5 BL
ZAP/TW 1 RT	2 mm	red	50	1683660000	ZTR 2.5/0. TNHE
ZAP/TW 1 SW	2 mm	black	50	1683730000	
Width 2 mm					
ZAP/TW 2 DB	2 mm	dark beige	50	1608770000	ZDU 2.5/3AN
ZAP/TW 2 BL	2 mm	blue/light blue	50	1608780000	ZDU 2.5/3AN BL
ZAP/TW 2 GN	2 mm	green	50	1683760000	ZPE 2.5/3AN
ZAP/TW 2 OR	2 mm	orange	50	1608790000	
ZAP/TW 2 RT	2 mm	red	50	1683740000	
Width 2 mm					
ZAP/TW 3	2 mm	dark beige	50	1608800000	ZDU 2.5/2X2AN
ZAP/TW 3 BL	2 mm	blue/light blue	50	1608810000	ZSI 2.5
ZAP/TW 3 GN	2 mm	green	50	1683840000	ZSI 2.5/5X25
ZAP/TW 3 GR	2 mm	grey	50	1683870000	ZSI 2.5/LD 120AC
ZAP/TW 3 OR	2 mm	orange	50	1608820000	ZSI 2.5/LD 250AC
ZAP/TW 3 RT	2 mm	red	50	1683820000	ZSI 2.5/LD 28AC
ZAP/TW 3 SW	2 mm	black	50	1683890000	ZSI 2.5/LD 60AC
ZAP/TW 3 WS	2 mm	white	50	1683880000	ZTR 2.5/3AN
					ZTR 2.5/3AN BL
					ZTR 2.5/3AN/0.TNHE
					ZTR 2.5/4AN
					ZDU 2.5/2X2AN BL
					ZTR 2.5/4AN BL
					ZTR 2.5/4AN/0 TNHE
					ZDU 2.5/2X2AN/D+
					ZDU 2.5/2X2AN/D-
					ZDU 2.5/2X2AN/LD+
					ZDU 2.5/2X2AN/LD-
					ZDU 2.5/4AN
					ZDU 2.5/4AN BL
					ZPE 2.5/4AN
Width 1.5 mm					
ZAP/TW ZDK2.5	1.5 mm	dark beige	20	1674730000	ZDK 2.5
ZAP/TW ZDK2.5 BL	1.5 mm	blue/light blue	20	1748800000	ZDK 2.5/D/1
ZAP/TW ZDK2.5 OR	1.5 mm	orange	20	1690080000	ZDK 2.5/D/2
					ZDK 2.5/D/4
					ZDK 2.5/D/5
					ZDK 2.5/D/6
					ZDK 2.5/LD RT/1
					ZDK 2.5/LD RT/2
					ZDK 2.5V
					ZDK 2.5 BL
					ZDK 2.5 DU-PE
					ZDK 2.5 EM
					ZDK 2.5 N-DU
					ZDK 2.5 N-PE
					ZDK 2.5 OR
					ZDK 2.5 PE
					ZDK 2.5 V BL

... for standard terminals

Type	Width	Colour	Qty.	Order No.	For terminal:
ZAP/TW ZDLD2.5-2N	1.5 mm	dark beige	20	1782340000	ZDLD 2.5-2 N/BL
ZAP/TW ZDLD2.5-2N BL	1.5 mm	blue	20	1782350000	ZDLD 2.5-2 VN
ZAP/TW ZDLD2.5-2N OR	1.5 mm	orange	20	1782360000	ZDLD 2.5-2 VN/BL ZDLD 2.5-2 N
Width 1.5 mm					
ZAP ZMAK2.5	1.5 mm	dark beige	10	1768010000	ZMAK 2.5
Width 1.5 mm					
AP ZDTR2.5	1.5 mm	dark beige	20	1745420000	ZDTR 2.5
AP ZDTR2.5 BL	1.5 mm	blue	20	1798340000	ZDTR 2.5 BL
Width 2 mm					
ZAP/TW 4 BL	2 mm	blue/light blue	50	1632100000	ZDU 4
ZAP/TW 4	2 mm	dark beige	50	1632090000	ZDU 4 BL
ZAP/TW 4 GN	2 mm	green	50	1683920000	ZPE 4
ZAP/TW 4 OR	2 mm	orange	50	1632110000	
Width 2 mm					
ZAP/TW 4/3AN BL	2 mm	blue	20	7904110000	ZDU 4/3AN
ZAP/TW 4/3AN OR	2 mm	orange	20	7904120000	ZDU 4/3AN BL
ZAP/TW 4/3AN	2 mm	dark beige	20	7904100000	ZPE 4/3AN
Width 2 mm					
ZAP/TW4/4AN	2 mm	dark beige	20	7904210000	ZDU 4/4AN
ZAP/TW4/4AN BL	2 mm	blue	20	7904220000	ZDU 4/4AN BL
ZAP/TW4/4AN OR	2 mm	orange	20	7904230000	ZPE 4/4AN
Width 2 mm					
ZAP/TW 5	2 mm	dark beige	50	1608830000	ZDU 6
ZAP/TW 5 BL	2 mm	blue/light blue	50	1608840000	ZDU 6 BL
ZAP/TW 5 OR	2 mm	orange	50	1608850000	ZPE 6
Width 2 mm					
ZAP/TW6/3AN BL	2 mm	blue	20	7907380000	ZDU 6/3AN
ZAP/TW6/3AN OR	2 mm	orange	20	7907390000	ZDU 6/3AN BL
ZAP/TW6/3AN	2 mm	dark beige	20	7907370000	ZPE 6/3AN
Width 2.7 mm					
ZAP/TW ZDU10	2.7 mm	beige	20	1748660000	ZDU 10
ZAP/TW ZDU10 BL	2.7 mm	blue/light blue	20	1764110000	ZDU 10 BL ZPE 10
Width 3 mm					
ZAP/TW 10/16	3 mm	beige	20	1749580000	ZDU 10/3AN
ZAP/TW 10/16 BL	3 mm	blue	20	1768520000	ZDU 10/3AN BL ZDU 16/3AN ZDU 16/3AN BL ZPE 10/3AN ZPE 16/3AN
Width 3 mm					
ZAP/TW ZDU16	3 mm	dark beige	20	1745150000	ZDU 16
ZAP/TW ZDU16 BL	3 mm	blue/light blue	20	1764100000	ZDU 16 BL ZPE 16

... for roof-style terminals

Type	Width	Colour	Qty.	Order No.	For terminal:
ZAP/TW7	2.5 mm	dark beige	50	1706110000	ZDU 2.5-2
ZAP/TW7 BL	2.5 mm	blue/light blue	50	1706120000	ZDU 2.5-2 BL
ZAP/TW7 OR	2.5 mm	orange	50	1706130000	ZDU 2.5-2/3AN ZDU 2.5-2/3AN BL ZDU 2.5-2/4AN ZDU 2.5-2/4AN BL ZDU 2.5-2/D+ ZDU 2.5-2/D- ZPE 2.5-2 ZPE 2.5-2/3AN ZPE 2.5-2/4AN ZTR 2.5-2 ZTR 2.5-2 BL ZTR 2.5-2/O.TNHE
Width 2 mm					
ZAP/TW ZDK2.5-2	2 mm	dark beige	20	1791050000	ZDK 2.5-2
ZAP/TW ZDK2.5-2 BL	2 mm	blue	20	1791060000	ZDK 2.5-2 BL
ZAP/TW ZDK2.5-2 OR	2 mm	orange	20	1791070000	ZDK 2.5-2 PE ZDK 2.5V ZDK 2.5V BL

... for roof-style terminals

Type	Width	Colour	Qty.	Order No.	For terminal:
ZAP/TW ZDKPE2.5-2	2 mm	dark beige	25	1805960000	ZDKPE 2.5-2 ZDKPE 2.5-2/N/L/PE
Width 2 mm					
ZAP ZDU4-2	2 mm	dark beige	50	1770400000	ZDU 4-2/2AN
ZAP ZDU4-2 BL	2 mm	blue	50	1770880000	ZDU 4-2/2AN BL
ZAP ZDU4-2 OR	2 mm	orange	50	1770890000	ZDU 4-2/3AN ZDU 4-2/3AN BL ZDU 4-2/3AN LSC ZPE 4-2/2AN ZPE 4-2/3AN
Width 2 mm					
ZAP ZDU4-2/4AN	2 mm	dark beige	50	1807010000	ZDU 4-2/4AN
ZAP ZDU4-2/4AN BL	2 mm	blue	50	1807020000	ZDU 4-2/4AN BL
ZAP ZDU4-2/4AN OR	2 mm	orange	50	1807030000	ZPE 4-2/4AN
Width 2.5 mm					
ZAP ZDU6-2	2.5 mm	dark beige	50	1771440000	ZDU 6-2/2AN
ZAP ZDU6-2 BL	2.5 mm	blue	50	1771450000	ZSI 6-2 2X2.5/G20
ZAP ZDU6-2 OR	2.5 mm	orange	50	1771460000	ZSI 6-2 2X2.5/G20/LD1 ZSI 6-2 2X2.5/G20/LD2 ZSI 6-2 2X2.5/G20/LD3 ZSI 6-2 2X2.5/G20/LD4 ZSI 6-2/FC ZSI 6-2/FC LD ZTR 6-2 ZTR 6-2 E / 230V UC ZTR 6-2 E / 24V DC ZDU 6-2/2AN BL ZDU 6-2/3AN ZDU 6-2/3AN BL ZPE 6-2/2AN ZPE 6-2/3AN ZSI 2.5-2/2X2AN/G20 ZSI 2.5-2/2X2AN/G20/LD1 ZSI 2.5-2/2X2AN/G20/LD2
ZAP ZDU6-2 SW	2.5 mm	black	50	1814710000	
Width 2.5 mm					
ZAP/Z...16-2/1AN	2.5 mm	dark beige	10	1772970000	ZPE 16-2/1AN

... for initiator-actuator terminals

Type	Width	Colour	Qty.	Order No.	For terminal:
ZAP/TW ZPV1.5	5.1 mm	dark beige	50	1674650000	ZAP/TW ZPV1.5 ZPV 1.5
Width 5.1 mm					
ZAP/TW ZIA1.5/3L	5.1 mm	beige		1649540000	ZIA 1.5/3L-1S ZIA 1.5/3L-1S/LD ZIA 1.5/3L-PE
Width 5.1 mm					
ZAP/TW ZIA1.5/4L	5.1 mm	beige		1649550000	ZIA 1.5/4L-1S ZIA 1.5/4L-1S/LD ZIA 1.5/4L-PE
Width 5 mm					
AP ZRV1.5 DB	5 mm	dark beige	10	1698180000	

... for installations terminals

Type	Width	Colour	Qty.	Order No.	For terminal:
ZAP ZDU10/16S	2 mm	dark beige	20	1739660000	ZDU 10/NT ZDU 10S ZDU 10S BL ZDU 16S ZDU 16S BL ZNT 10S ZNT 16S ZPE 10S ZPE 16S
Width 2 mm					
ZAP ZDU 2.5 S	2 mm	dark beige	20	1808030000	ZDU 2.5 S
ZAP ZDU 2.5 S BL	2 mm	blue	20	1808040000	ZDU 2.5 S BL
ZAP ZDU 2.5 S OR	2 mm	orange	20	1808050000	ZNT 2.5 S ZPE 2.5 S
Width 2 mm					
ZAP ZDU 4 S	2 mm	dark beige	20	1808380000	ZDU 4 S
ZAP ZDU 4 S BL	2 mm	blue	20	1808390000	ZDU 4 S BL ZNT 4 S ZPE 4 S
Width 2 mm					
ZAP ZDU 6 S	2 mm	dark beige	20	1808250000	ZDU 6 S
ZAP ZDU 6 S BL	2 mm	blue	20	1808260000	ZDU 6 S BL ZNT 6 S ZPE 6 S
Width 3 mm					
ZHP S	3 mm	blue	20	1808290000	ZDU 2.5 S
ZHP S SO	3 mm	blue	20	1808280000	ZPE 2.5 S ZPE 4 S ZPE 6 S ZDU 2.5 S BL ZDU 4 S ZDU 4 S BL ZDU 6 S ZDU 6 S BL ZNT 2.5 S ZNT 4 S ZNT 6 S

... for mini-terminals

Type	Width	Colour	Qty.	Order No.	For terminal:
ZAP/TW ZDUA	1.5 mm	dark beige	50	1720960000	ZDUA 2.5-2
ZAP/TW ZDUA BL	1.5 mm	blue/light blue	50	1720970000	ZDUA 2.5-2 BL
ZAP/TW ZDUA OR	1.5 mm	orange	50	1720980000	ZPEA 2.5-2
Width 2.5 mm					
ZAP/TW ZDUA2.5-2N	2.5 mm	dark beige	50	1808170000	ZDUA 2.5-2N ZDUA 2.5-2N BL ZPEA 2.5-2N
Width 5 mm					
ZAP ZDUB	5 mm	dark beige	50	1704750000	ZDUB 2.5-2/2AN/15
ZAP ZDUB BL	5 mm	blue/light blue	50	1704760000	ZDUB 2.5-2/2AN/RC BL
ZAP ZDUB OR	5 mm	orange	50	1704770000	ZDUB 2.5-2/2AN/RC OR ZDUB 2.5-2/2AN/RC GE ZDUB 2.5-2/4AN/15 ZDUB 2.5-2/4AN/15 BL ZDUB 2.5-2/4AN/DB ZDUB 2.5-2/4AN/DB BL ZDUB 2.5-2/4AN/DB GE ZDUB 2.5-2/4AN/DM ZDUB 2.5-2/4AN/DM BL ZDUB 2.5-2/2AN/15 BL ZDUB 2.5-2/4AN/DM GE ZDUB 2.5-2/4AN/RC ZDUB 2.5-2/4AN/RC/BL ZDUB 2.5-2/4AN/RC/GE ZPEB 2.5-2/2AN ZDUB 2.5-2/2AN/DB ZDUB 2.5-2/2AN/DB BL ZDUB 2.5-2/2AN/DB GE ZDUB 2.5-2/2AN/DM ZDUB 2.5-2/2AN/DM BL ZDUB 2.5-2/2AN/DM GE ZDUB 2.5-2/2AN/RC
Width 5 mm					
ZTW ZDUB	5 mm	dark beige	50	1704340000	ZDUB 2.5-2/2AN/15 ZDUB 2.5-2/2AN/RC BL ZDUB 2.5-2/2AN/RC GE ZDUB 2.5-2/2AN/RC OR ZDUB 2.5-2/4AN/15 ZDUB 2.5-2/4AN/15 BL ZDUB 2.5-2/4AN/DB ZDUB 2.5-2/4AN/DB BL ZDUB 2.5-2/4AN/DB GE ZDUB 2.5-2/4AN/DM ZDUB 2.5-2/4AN/DM BL ZDUB 2.5-2/2AN/15 BL ZDUB 2.5-2/4AN/DM GE ZDUB 2.5-2/4AN/RC ZDUB 2.5-2/4AN/RC/BL ZDUB 2.5-2/4AN/RC/GE ZPEB 2.5-2/2AN ZDUB 2.5-2/2AN/DB ZDUB 2.5-2/2AN/DB BL ZDUB 2.5-2/2AN/DB GE ZDUB 2.5-2/2AN/DM ZDUB 2.5-2/2AN/DM BL ZDUB 2.5-2/2AN/DM GE ZDUB 2.5-2/2AN/RC

... for WeiCoS pluggable terminals

Type	Width	Colour	Qty.	Order No.	For terminal:
ZAP/TW ZT2.5/2AN	2.5 mm	dark beige	50	1816030000	ZT 2.5/2AN/1
ZAP/TW ZT2.5/2AN OR		orange	50	1816040000	ZTPE 2.5/2AN/1
ZAP/TW ZT2.5/3AN	2.5 mm	dark beige	50	1816050000	ZT 2.5/3AN/1 ZTPE 2.5/3AN/1
ZAP/TW ZT2.5/4AN/2	2.5 mm	dark beige	50	1816070000	ZT 2.5/4AN/2
ZAP/TW ZT2.5/4AN/2 OR		orange	50	1816080000	ZTPE 2.5/4AN/2
ZAP/TW ZT2.5/4AN/4	2.5 mm	dark beige	50	1816090000	ZT 2.5/4AN/4 ZTC 2.5/4AN/4 ZTCPE 2.5/4AN/4 ZTPE 2.5/4AN/4
ZAP/TW ZDT2.5/2	2.5 mm	dark beige	50	1816110000	ZDT 2.5/2 ZDT 2.5/2 DU-PE ZDT 2.5/2 PE
ZAP/TW ZTTR2.5		dark beige	50	186520000	ZTTR 2.5 ZTTR 2.5/O. TNHE

... for double- / multi-layer terminal blocks

Type	Width	Colour	Qty.	Order No.	For terminal:
ZAP ZVLD 2.5	1.5 mm	dark beige	10	1210410000	ZVLD 2.5

... for custom applications

Type	Width	Colour	Qty.	Order No.	For terminal:
ZTW ZTL6	2 mm	dark beige	20	1771870000	ZTD 6
ZTW ZTL6 OR		orange	20	1771880000	ZTD 6/STB ZTL 6 ZTL 6/STB
ZAP ZDU4/NT	1.5 mm	dark beige	20	1757970000	ZDU 4/NT ZDU 4/NT DB
ZAP ZDU10/16S	2.5 mm	dark beige	20	1739660000	ZDU 10/NT ZDU 10S ZDU 10S BL ZDU 16S ZDU 16S BL ZNT 10S ZNT 16S ZPE 10S ZPE 16S

ZEI 16 supply terminal

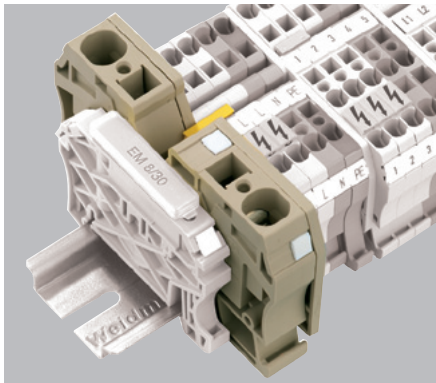

Integrated partition plate

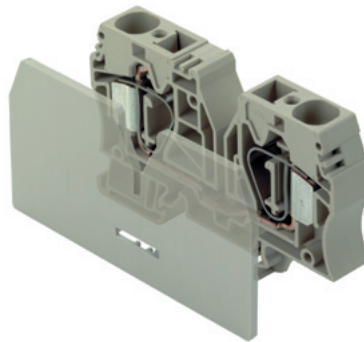

Output possible on left and right

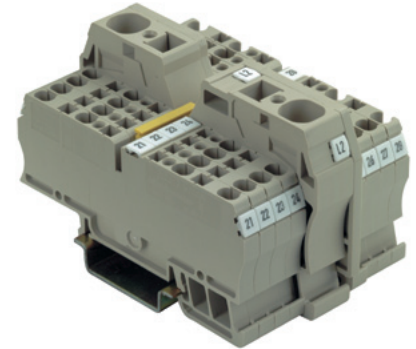

C

The ZEI 16 supply terminal can be used for supplying current up to a conductor cross-section of 25 mm². Standard cross-connections then distribute the current to any number of terminals with a smaller cross-sectional area.

The following tables show a number of options for distributing current at the supply point, together with corresponding cross-connections and the maximum current.

Output options and corresponding cross-connections

Feed terminal	Output terminal	Cross-connection	Supply left	Supply right
ZEI 16	ZDU 2.5	ZQV 2.5/...	•	•
	ZDU 2.5/4AN	ZQV 2.5/...	•	•
	ZDU 2.5N	ZQV 2.5/...	•	•
	ZDU 2.5N/3AN	ZQV 2.5/...	•	•
	ZDU 2.5N/4AN	ZQV 2.5/...	•	•
	ZDU 4	ZQV 4/...	•	•
	ZDU 4/3AN	ZQV 4/...	•	• 1)
	ZDU 4/4AN	ZQV 4/...	•	• 1)
	ZDU 6	ZQV 6/...	•	•
	ZDU 6/3AN	ZQV 6/...	•	• 1)
	ZTR 2.5	ZQV 2.5/...	• 2)	• 2)
	ZTR 2.5/3AN	ZQV 2.5/...	• 2)	• 2)
ZTR 2.5/4AN	ZQV 2.5/...	•	•	
Feed terminal	Output terminal	Cross-connection	Supply left	Supply right
ZEI 6	ZDU 1.5	ZQV 1.5/...	•	•
	ZDU 1.5/3AN	ZQV 1.5/...	•	•
	ZDU 1.5/4AN	ZQV 1.5/...	•	•

1) with IEPL 2) with QVAR

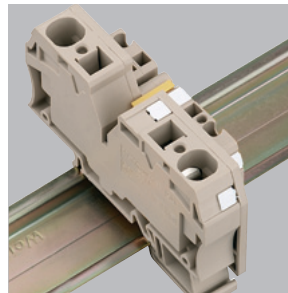

$$I_{max} = \sum I_n \text{ (links)}$$

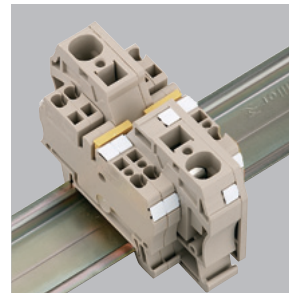

$$I_{max} = \sum I_n \text{ (left)} + \sum I_n \text{ (right)}$$

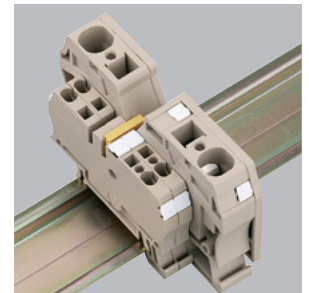

$$I_{max} = \sum I_n \text{ (right)}$$

Ordering data

Type	Colour	Qty.	Order No.
ZEI 16	dark beige	20	1745350000
ZEI 16 BL	blue	20	1766240000
IEPL	dark beige	20	1859570000
QVAR	dark beige	20	1836370000

Maximum current flow I_{max} only with ZEI 16

Feed terminal	Cross-connection	Supply conductor cross-section area	Supply left or right	Supply middle
ZDU 2.5	ZQV 2.5	16 mm ²	48 A	76 A
		25 mm ²	48 A	89 A
ZDU 2.5/4AN	ZQV 2.5	16 mm ²	48 A	76 A
		25 mm ²	48 A	89 A
ZDU 4	ZQV 4	16 mm ²	64 A	76 A
		25 mm ²	66 A	100 A
ZDU 6	ZQV 6	16 mm ²	76 A	76 A
		25 mm ²	82 A	100 A

Supply with standard terminals

According to IEC 60204-1 and IEC 60 439-1, when reducing the conductors within distribution boards and controllers, protective devices for cables and conductors can be installed up to a maximum of 3 meters away from the supply side and need not be positioned at the beginning of the supply side. The conductor before the output fuse must be routed to make it "short-circuit proof".

Supply on the left

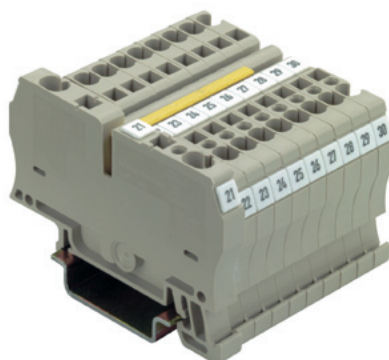

Supply on the right



Supply options and corresponding cross-connections

		on the right											
Output terminals	Supply terminals	ZDU 2.5	ZDU 2.5/3AN	ZDU 2.5/4AN	ZDU 2.5N	ZDU 2.5N/3AN	ZDU 2.5N/4AN	ZDU 4	ZDU 4/3AN	ZDU 4/4AN	ZTR 2.5	ZTR 2.5/3AN	ZTR 2.5/4AN
		on the left											
ZDU 4		•	• 2)	•	•	• 2)	•	•	•	•	• 2)	• 2)	•
ZDU 4/3AN		• 1)	• 2)	• 1)	• 1)	• 2)	• 1)	•	•	•	• 2)	• 2)	•
ZDU 4/4AN		• 1)	• 2)	• 1)	• 1)	• 2)	• 1)	•	•	•	• 2)	• 2)	• 1)
ZDU 6		• 3)	• 2)	•	•	• 2)	•	•	•	•	• 2)	• 2)	•
ZDU 6/3AN		• 1)	•	• 1)	• 1)	• 1)	•	•	•	•	•	•	• 1)
		on the left											
Output terminals	Supply terminals	ZDU 2.5	ZDU 2.5/3AN	ZDU 2.5/4AN	ZDU 2.5N	ZDU 2.5N/3AN	ZDU 2.5N/4AN	ZDU 4	ZDU 4/3AN	ZDU 4/4AN	ZTR 2.5	ZTR 2.5/3AN	ZTR 2.5/4AN
		on the right											
ZDU 4		•	• 2)	• 1)	•	• 2)	• 1)	•	•	•	• 2)	• 2)	• 1)
ZDU 4 / 3 AN		•	• 2)	• 1)	•	• 2)	• 1)	•	•	•	• 2)	• 2)	• 1)
ZDU 4 / 4 AN		•	• 2)	• 1)	•	• 2)	• 1)	•	•	•	• 2)	• 2)	• 1)
ZDU 6		• 3)	• 2)	• 1)	•	• 2)	• 1)	•	•	•	• 2)	• 2)	• 1)
ZDU 6 / 3 AN		•	• 2)	• 1)	•	• 2)	• 1)	•	•	•	• 2)	• 2)	•

1) with IEPL 2) with QVAR
 3) Maximum current value at the smallest cross-section:
 - ZDU 6 with ZQV 2.5/3 to ZDU 2.5: 55 A
 - ZDU 6 with ZQV 2.5/4 to ZDU 2.5: 57 A

Pluggable Cross-Connection ZQV

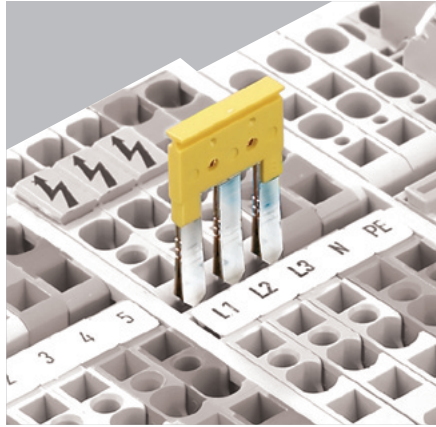

The time-saving, easy-to-use cross-connection comb for terminals, featuring tension clamp technology.

- **ZQV 2.5** as 2- to 10-pole combs and ZQV 2.5/20 – continuous (20-pole)
- **ZQV 2.5N** as 2- to 10-pole combs and ZQV 2.5N/20 – continuous (20-pole)
- **ZQV 4** as 2- to 10-pole combs and ZQV4/20 – continuous (20-pole)
- **ZQV 6** as 2- to 4-pole combs and ZQV6/32 – continuous (24-pole)
- **ZQV 10, ZQV 16** and **ZQV 35** as 2-pole combs (bridges)
- **ZQV 35-10, ZQV 35-16** and **ZQV 16-10** used as a reducer cross-connector distributes current from terminals with larger cross-connections to terminals with smaller cross-section.

These versions come with complete shock protection.

However, please note that the rated voltage is reduced to 400 V when using cross-connections. This does not apply to terminals with a rated voltage below 400 V. Here the rated voltage of the used terminal is mandatory.

Breaking out contact elements

If one or more (max. 60 % for reasons of stability and temperature rise) of the contact elements are broken out of the cross-connections, terminals may be bypassed to suit the application.



Fitting and changing crossconnections

The fitting and changing of cross-connections is a trouble-free and fast operation:

- Insert the cross-connection into the cross-connection channel in the terminal...



... and press it fully home. (The cross-connection may not project from the channel.)

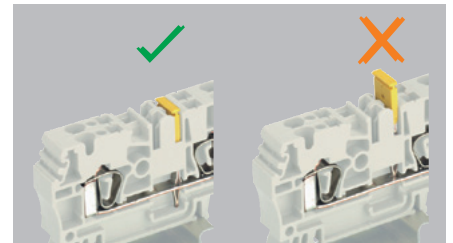

- Remove a cross-connection by simply prising it out with a screwdriver.

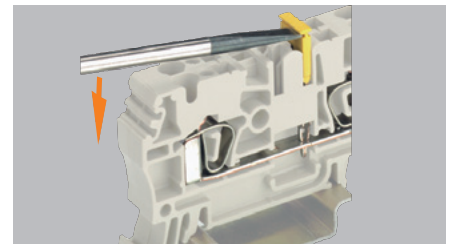

Shortening cross-connections

Cross-connections can be shortened in length using a suitable cutting tool, e.g. KT ZQV (order no. 9002170000). However, three contact elements must always be retained.

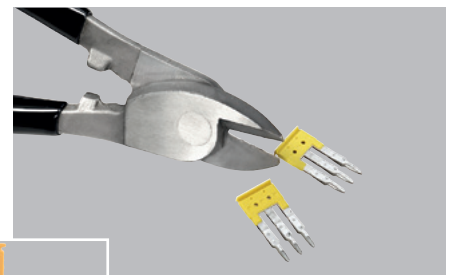

Caution:
Contact elements must not be deformed!



If the user shortens the cross-connections it is necessary to use isolating or end plates (ZAP/TW...) with the terminals in order to maintain the rated voltage of 250 V. (On the bare, cut edges of the cross-connector.)



Possible combinations

In one cross-connection channel

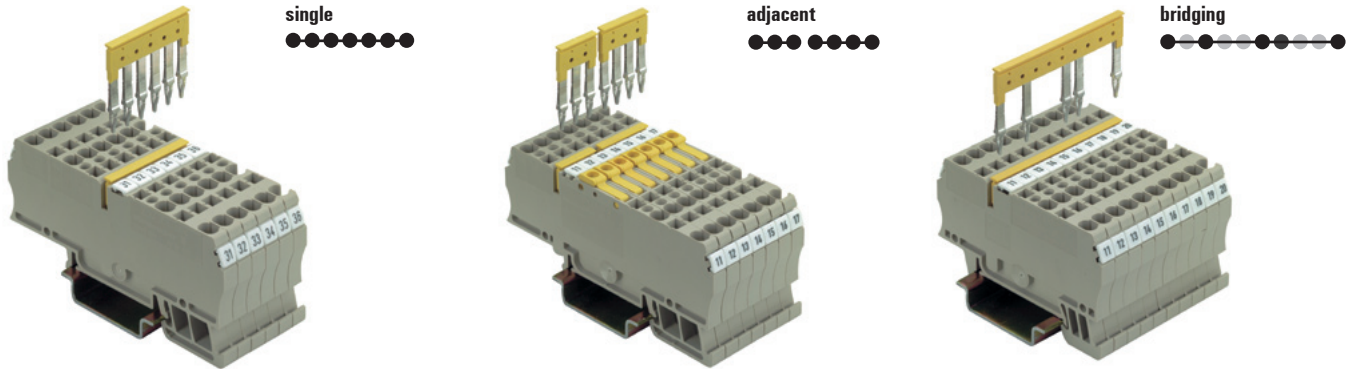

In two cross-connection channels

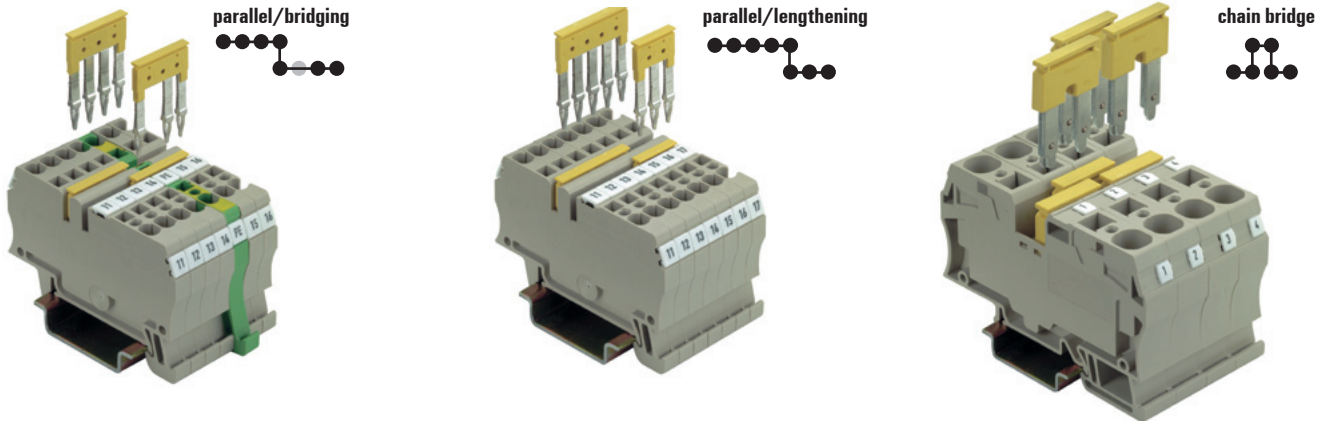

Possible cross-connections of terminals of the same type with corresponding cross-connections

Terminal type	Querverbindung	single	adjacent	bridging	Kettenbrücke	parallel bridging	parallel lengthening
Standard terminals							
ZDU 2.5	ZQV 2.5/...	•	•	•	•	•	•
ZDU 2.5 / 3 AN	ZQV 2.5/...	•	•	•			
ZDU 2.5 / 4 AN	ZQV 2.5/...	•	•	•			
ZDU 2.5N	ZQV 2.5/...	•	•	•	•	•	•
ZDU 2.5N / 3 AN	ZQV 2.5/...	•	•	•			
ZDU 2.5N / 4 AN	ZQV 2.5/...	•	•	•			
ZTR 2.5 ...	ZQV 2.5/...	•	•	•			
ZSI 2.5 ...	ZQV 2.5/...	•	•	•			
ZDU 4 ...	ZQV 4/...	•	•	•			
ZDU 6 ...	ZQV 6/...	•	•	•			
ZDU 10, ZDU 16, ZDU 35	ZQV 10/2	•			•		
ZPE 2.5	ZQV 2.5/...			•		•	•
ZPE 4	ZQV 4/...			•			
ZPE 6	ZQV 6/...			•			
ZPE 10, ZPE 16, ZPE 35	ZQV 10	•			•		
Roof-Style terminals							
ZDU 2.5-2	ZQV 2.5/...	•	•	•	•	•	•
ZDU 2.5-2 / 3 AN	ZQV 2.5/...	•	•	•	•	•	•
ZDU 4-2/...	ZQV 4/...	•	•	•	•		•
ZDU 6-2/...	ZQV 6/...	•	•	•			
ZPE 2.5-2	ZQV 2.5/...			•		•	
ZPE 2.5-2 / 3 AN	ZQV 42.5/...			•		•	
ZPE 4-2/...	ZQV 4/...			•		•	
ZPE 6-2/...	ZQV 6/...			•			

Alternative cross-connections available

Terminals with different rated cross-section

term. type 1
ZDU 4

req. cross-connection
ZQV 2.5/...

term. type 2
ZDU 2.5

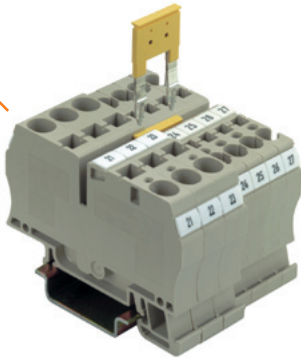

term. type 1
ZDU 6

req. cross-connection
ZQV 4/...

term. type 2
ZDU 4

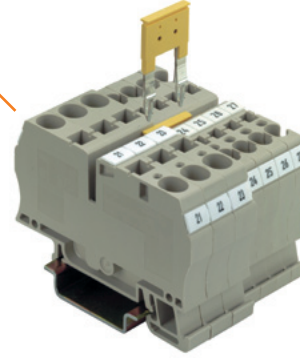

Fuse terminals with same rated cross-section

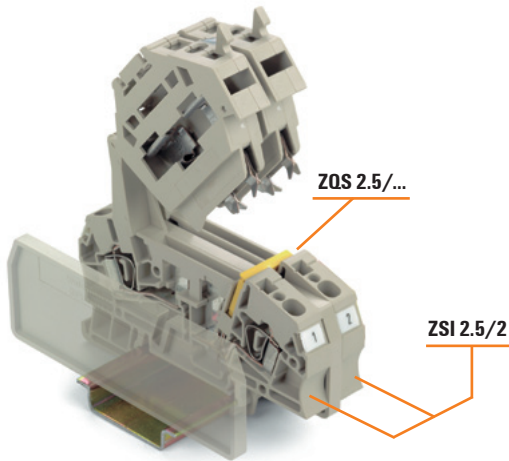

It is necessary to break out the cross-connection panel in the side wall of the fuse terminal.



Terminals without cross-connection channel – ZDU 2.5-2 / 4 AN

To cross connect ZDU 2.5-2/4 AN terminals, which do not have cross-connection channels, use the ZQB 2.5 cross-connection bridge to provide a simple cross-connection solution.

The illustration shows how to fit **ZQB 2.5** correctly.

Always ensure that the conductor is placed between the tension clamp and ZQB 2.5.

The conductor cross-sections is reduced to 1.5 mm² "e" and "f" as a result of using ZQB 2.5.

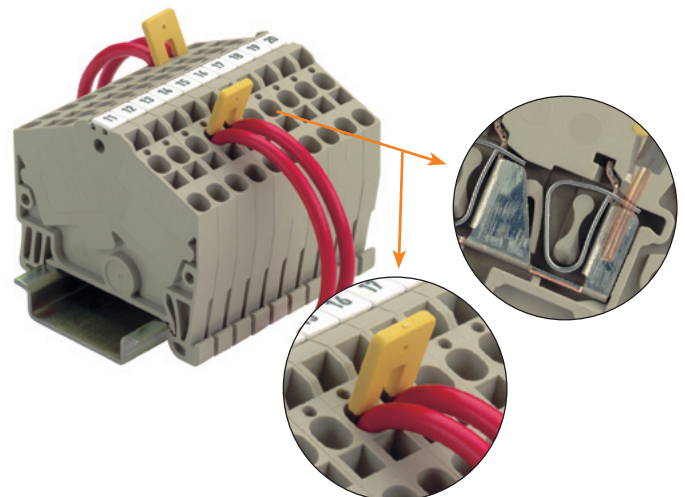

Cross-connections according to dimensions

ZQV 1.5



Technical data	
Current / Current	A
Ordering data	
2-pole	
3-pole	
4-pole	
5-pole	
6-pole	
7-pole	
8-pole	
9-pole	
10-pole	
20-pole	
32-pole	

17.5 / 17.5		
Type	Qty.	Order No.
ZQV 1.5/2	60	1776120000
ZQV 1.5/3	60	1776130000
ZQV 1.5/4	60	1776140000
ZQV 1.5/5	20	1776150000
ZQV 1.5/10	20	1776200000

For terminal:

ZDU 1.5 ...	
ZDK 1.5 ...	
ZEI 6	

ZQV 2.5



24 / 24		
Type	Qty.	Order No.
ZQV 2.5/2	60	1608860000
ZQV 2.5/3	60	1608870000
ZQV 2.5/4	60	1608880000
ZQV 2.5/5	20	1608890000
ZQV 2.5/6	20	1608900000
ZQV 2.5/7	20	1608910000
ZQV 2.5/8	20	1608920000
ZQV 2.5/9	20	1608930000
ZQV 2.5/10	20	1608940000
ZQV 2.5/20	20	1908960000

For terminal:

ZDU 2.5 ...	ZDK 2.5-2
ZDK 2.5 ...	ZTR 2.5-2 ...
ZTR 2.5 ...	ZDL 2.5-2 ...
ZDTR 2.5	ZDKPE 2.5-2
ZTSI 2.5 ...	ZDU 2.5N ...
ZRV 2.5 ...	ZNT 2.5/3AN ...
ZIA 2.5 ...	ZEI 16-2/1 AN
ZEI 16	ZDU 2.5 S
ZDU 2.5-2 ...	ZTN 2.5 S

ZQV 4



32 / 32		
Type	Qty.	Order No.
ZQV 4/2 GE	60	1608950000
ZQV 4/3 GE	60	1608960000
ZQV 4/4 GE	60	1608970000
ZQV 4/5 GE	20	1608980000
ZQV 4/6 GE	20	1608990000
ZQV 4/7 GE	20	1609000000
ZQV 4/8 GE	20	1609010000
ZQV 4/9 GE	20	1609020000
ZQV 4/10 GE	20	1609030000
ZQV 4/20 GE	20	1909010000

For terminal:

ZDU 4 ...	ZDU 4-2 ...
ZDK 4/S ...	ZDU 4 S
ZEI 16	ZNT 4 S
	ZEI 16-2/1 AN

Cross-connections according to dimensions

ZQV 35-10

Reducing cross-connection



Technical data	
Current / Current	A
Ordering data	
2-pole	
3-pole	
4-pole	
5-pole	
6-pole	
7-pole	
8-pole	
9-pole	
10-pole	
20-pole	
32-pole	

57 / 105		
Type	Qty.	Order No.
ZQV 35-10	10	7920100000

For terminal:

ZDU 10 ...	ZDU 10 S
ZPE 10 ...	ZNT 10 S
ZDU 35	
ZPE 35	

ZQV 2.5N



24 / 24		
Type	Qty.	Order No.
ZQV 2.5N/2 GE	60	1693800000
ZQV 2.5N/3 GE	60	1693810000
ZQV 2.5N/4 GE	60	1693820000
ZQV 2.5N/5 GE	20	1693830000
ZQV 2.5N/6 GE	20	1693840000
ZQV 2.5N/7 GE	20	1693850000
ZQV 2.5N/8 GE	20	1693860000
ZQV 2.5N/9 GE	20	1693870000
ZQV 2.5N/10 GE	20	1693880000

For terminal:

ZT 2.5 ...	ZDUA 2.5-2 ...
ZDT 2.5 ...	ZDUA 2.5-2N ...
ZP 2.5 ...	ZDL 2.5 ...
ZTTQ 2.5 ...	ZDL 2.5 S
ZTC ...	

ZQB 2.5



24 / 24		
Type	Qty.	Order No.
ZQB 2.5-2	50	1677120000

For terminal:

	ZDUB 2.5-2/4 AN
	ZDU 2.5-2/4 AN

The ZQB 2.5 cross-connector is used for connecting terminals without a separated cross-connection channel.
The ZBW tools is used for opening the terminal points. (order no. 1650670000)

ZQV 6



41 / 41

Type	Qty.	Order No.
ZQV 6/2 GE	60	1627850000
ZQV 6/3 GE	60	1627860000
ZQV 6/4 GE	60	1627870000
ZQV 6/24	10	1908990000

For terminal:

ZDU 6 ...	ZDU 6-2 ...
ZDK 6/S ...	ZDU 6 S
ZTL 6 ...	ZNT 6 S
ZEI 16 ZEI	ZEI 16-2/1 AN

ZQV 10/2

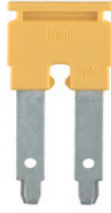

57 / 57*

Type	Qty.	Order No.
ZQV 10/2	25	1739680000

For terminal:

ZDU 10 ...	ZDU 10 S
ZDU 10 NT	ZNT 10 S

* Only with use of 2 dummy cables

ZQV 16/2

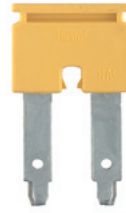

76 / 76*

Type	Qty.	Order No.
ZQV 16/2	25	1739690000

For terminal:

ZDU 16	ZDU 16 S
ZPE 16	ZPE 16 S
	ZNT 16 S

* Only with use of 2 dummy cables

ZQV 35/2



105 / 105

Type	Qty.	Order No.
ZQV 35/2	10	1739700000

For terminal:

ZDU 35
ZPE 35
ZNT 35/S

ZQS 2.5



/ 10

Type	Qty.	Order No.
ZQS 2.5/2	20	1633200000
ZQS 2.5/3	20	1633210000
ZQS 2.5/4	20	1633220000
ZQS 2.5/5	20	1633230000

For terminal:

ZSI 2.5/2 ...

ZVQ 2.5/1.5



/ 23

Type	Qty.	Order No.
ZVQ 2.5/1.5	50	1720700000

For terminal:

ZDK 2.5 ...	ZDLD 2.5-2 ...
ZDT 2.5/2	

Test adapter

The clip-on test adapter ZTA is used as a single thin element and as a test adapter strip for measurements in electrical cabinets. Conductors with cross-sections from 0.5 mm² to 1.5 mm² can be connected. The test adapter simply clips onto the terminal and thus guarantees reliable contact with the live busbar.

Dimensions	
Width / Length / Height ¹⁾	mm
Stripping length	mm
Rated data	
Rated voltage	V
Rated current	A
Rated cross-section	mm ²
Clamped conductors (H05V/H07V)	
solid / stranded	mm ²
flexible / Flexible with ferrule	mm ²
Ordering data	
	1-pole
	With snap-in pegs

ZTA 1

For terminal width 5.1 mm



5.1 / 31.5		
6		
250		
9		
1.5		
0.5...1.5		
0.5...1.5 / 0.5...1.5		
Type	Qty.	Order No.
ZTA 1	25	1609040000
ZTA 1/ZA	25	1609050000
For terminal:		
ZDU 2.5 ...		
ZTR 2.5 ...		
ZSI 2.5 ...		
ZSI 2.5/2		

ZTA 2

For terminal width 6.1 mm



6.1 / 31.5		
6		
250		
9		
1.5		
0.5...1.5		
0.5...1.5 / 0.5...1.5		
Type	Qty.	Order No.
ZTA 2 ZDU4	25	1609060000
ZTA 2/ZA ZDU4	25	1609070000
For terminal:		
ZDU 4 ...		

ZTA 3

For terminal width 8.1 mm



8.1 / 31.5		
6		
250		
9		
1.5		
0.5...1.5		
0.5...1.5 / 0.5...1.5		
Type	Qty.	Order No.
ZTA 3 ZDU6	25	1654050000
For terminal:		
ZDU 6 ...		

Test adapter

The clip-on test adapter ZTA is used as a single thin element and as a test adapter strip for measurements in electrical cabinets. Conductors with cross-sections from 0.5 mm² to 1.5 mm² can be connected. The test adapter simply clips onto the terminal and thus guarantees reliable contact with the live busbar.

Dimensions	
Width / Length / Height ¹⁾	mm
Stripping length	mm
Rated data	
Rated voltage	V
Rated current	A
Rated cross-section	mm ²
Clamped conductors (H05V/H07V)	
solid / stranded	mm ²
flexible / Flexible with ferrule	mm ²
Ordering data	
	1-pole
	With snap-in pegs

ZTA 6

For terminal width 6.1 mm



6.1 / 31.5		
6		
250		
17.5		
1.5		
0.5...1.5		
0.5...1.5 / 0.5...1.5		
Type	Qty.	Order No.
ZTA 6/ZA	25	1780660000
For terminal:		
ZDU 4-2 ...		

ZTA 7

For terminal width 8.1 mm



8.1 / 31.5		
6		
250		
9		
1.5		
0.5...1.5		
0.5...1.5 / 0.5...1.5		
Type	Qty.	Order No.
ZTA 7/ZA	25	1780670000
For terminal:		
ZDU 6-2 ...		

ZTA ZT2.5

For terminal width 5.1 mm



5.1 / 20		
10		
250		
17.5		
1.5		
0.5...1.5		
0.5...1.5		
Type	Qty.	Order No.
ZTA ZT2.5	25	1827080000
ZTA ZT2.5/ZA	25	1847600000
For terminal:		
ZT 2.5 ...		

Note: 1) The height is dependent on the terminal type

ZTA 4

For terminal width 5.1 mm



5.1 / 31
10
250
11
1.5
0.5...1.5
0.5...1.5 / 0.5...1.5

Type	Qty.	Order No.
ZTA 4	25	1688110000

For terminal:
ZDK 2.5 ...
ZTR 2.5/4 AN ...

ZTA 5

For terminal width 3.5 mm



3.5 / 20
10
200
13.5
1
0.5...1
0.5...1 / 0.5...1

Type	Qty.	Order No.
ZTA 5	25	1776210000
ZTA 5/ZA	25	1776220000

For terminal:
ZDU 1.5 ...
ZDK 1.5 ...

ZTA ZVLD

For terminal width 5.1 mm



5.1 / 69
6
250
6
1.5
0.5...1.5

Type	Qty.	Order No.
ZTA ZVLD	25	1210390000
ZTA ZVLD/ZA	25	1271870000

For terminal:
ZVLD ...

Test plug

The test points for the PS 2.3 and PS 2.0 test plugs are available for most Z-Series terminals. Quick measurements can be made by inserting the test plug into the opening provided.

Technical data
Current / Current
-
Ordering data
Test plug

PS

Plug diameter 2.0 mm



Type	Qty.	Order No.
PS 2.0 OR	20	0293800000

For terminal:
ZDU/ZPE 2.5/...
ZDU/ZPE 4/...
ZDU/ZPE 6/3 AN
ZDU/ZPE 10/...
ZDU/ZPE 16/...
ZDU/ZPE 35
ZEI 16
ZTR 2.5/...
ZTR 2.5 .../D
ZDTR 2.5
ZTR 2.5/SI
ZDL 2.5/SI ...
ZTRR 2.5/2AN/1

PS 2.3 RT

Plug diameter 2.3 mm



Type	Qty.	Order No.
PS 2.3 RT	20	0180400000

For terminal:
ZDU/ZPE 2.5/...
ZDU/ZPE 4/...
ZDU/ZPE 10/...
ZDU/ZPE 18/...
ZDU/ZPE 35
ZDU/ZPE 42
ZDU/ZPE 62
ZTR 2.5...
ZTR 2.5.../D
ZDTR 2.5
ZTR 2.5/SI
ZDL 2.5/SI...
ZTRR 2.5/2AN/1

PS ZQV test probes

PS ZQV test probes

The PS ZQV test probes allow you to use only one product to test PUSH IN terminals.

PS ZQV

Test probes



- Safe and hand-free measuring of terminals
- Insert into the ZQV contact
- Very flexible silicone safety-measurement cables connect to any measurement instrument.

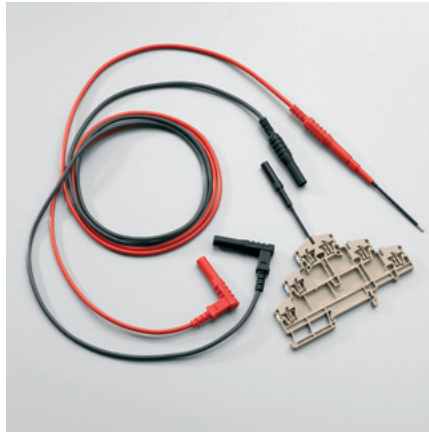

Technical data

DC voltage measuring range
 AC voltage measuring range
 Weight

Test probes
1000 V
1000 V

Note

Ordering data

Version

Type	Qty.	Order No.
**PS_ZQV_SET	1	1116710000
*PS_ZQV	1	1121740000

Note

Included in delivery: * 2 test probes (red and black)
 ** 2 test probes (red and black), 2 silicone safety-measurement cables (1.2 m, red and black)

Cover

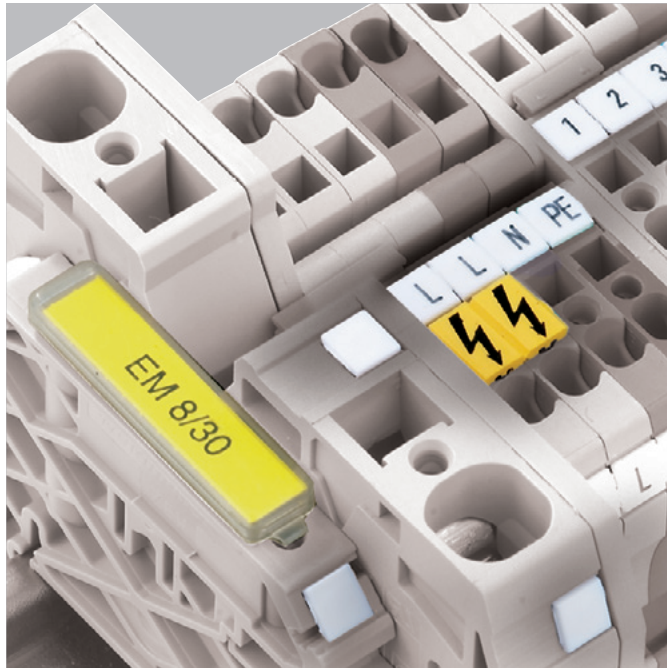

The VDE standards call for power connection terminals to be covered.

For this purpose, Weidmüller can supply yellow warning **ZAD** covers with the „lightning flash“ symbol.

The cover is clipped into the screwdriver slit in the terminal and each one covers a group of four terminals.

Operating tool

The fully-insulated **ZBW1** to **ZBW6** and **ZBWW** tools are used for opening 1.5 mm² and 2.5 mm² terminal points. They can be used to simultaneously open multiple terminal points.

The **ZBWW** tools, with its angled bit, makes it possible conveniently connect terminals in a confined space.

The plastic tools increase safety when working on facilities during operation.

Cover

Type	Colour	Qty.	Order No.	For terminal:
ZAD 7/4		20	1781940000	ZDK 1.5 ZDK 1.5 BL ZDK 1.5DU-PE ZDK 1.5V ZDK 1.5V BL ZDU 1.5 ZDU 1.5 2X2AN ZDU 1.5 2X2AN BL ZDU 1.5 BL ZDU 1.5/3 AN ZDU 1.5/3 AN/BL ZDU 1.5/4 AN ZDU 1.5/4 AN/BL ZDU 2.5/2X2AN/D+ ZDU 2.5/2X2AN/D- ZEI 16 ZEI 16 BL
Width				
ZAD 1/4		20	1609110000	ZDK 4-2 ZDU 2.5 BL ZDU 2.5/2X2AN ZDU 2.5/2X2AN BL ZDU 2.5/2X2AN/D+ ZDU 2.5/2X2AN/D- ZDU 2.5/2X2AN/LD+ ZDU 2.5/2X2AN/LD- ZDU 2.5/3AN ZDU 2.5/3AN BL ZDU 2.5/4AN ZDK 4-2 BL ZDU 2.5/4AN BL ZDU 4-2/2AN ZDU 4-2/2AN BL ZDU 4-2/3AN ZDU 4-2/3AN BL ZDU 4-2/3AN LSC ZDU 4-2/4AN ZDU 4-2/4AN BL ZDUA 2.5-2N ZDUA 2.5-2N BL ZDK 4-2 PE ZEI 16 ZEI 16 BL ZPE 4-2/4AN ZPEA 2.5-2N ZSI 2.5-2/2X2AN/G20 ZSI 2.5-2/2X2AN/G20/LD1 ZSI 2.5-2/2X2AN/G20/LD2 ZSI 6-2 2X2.5/G20 ZSI 6-2 2X2.5/G20/LD1 ZSI 6-2 2X2.5/G20/LD2 ZDK 4-2 V ZSI 6-2 2X2.5/G20/LD3 ZSI 6-2 2X2.5/G20/LD4 ZTR 2.5/4AN ZTR 2.5/4AN BL ZTR 2.5/4AN/O TNHE ZDK 4-2/D forward ZDK 4-2/D reverse ZDK 4-2/DU-PE ZDK 4-2/N/L ZDU 2.5

Cover

Type	Colour	Qty.	Order No.	For terminal:
ZAD 1/4-2 GE		20	1764560000	ZDK 2.5-2 ZDK 2.5-2 BL ZDK 2.5-2 PE ZDK 2.5V ZDK 2.5V BL ZDKPE 2.5-2 ZDKPE 2.5-2/N/L/PE ZDU 2.5-2 ZDU 2.5-2 BL ZDU 2.5-2/3AN ZDU 2.5-2/3AN BL ZDU 2.5-2/4AN ZDU 2.5-2/4AN BL ZDU 2.5/2X2AN/D+ ZDU 2.5/2X2AN/D- ZEI 16 ZEI 16 BL ZTR 2.5-2 ZTR 2.5-2 BL ZTR 2.5-2/O.TNHE
Width				
ZAD 2/4		20	1609080000	ZDU 2.5/2X2AN/D+ ZEI 16 BL ZSI 2.5-2/2X2AN/G20 ZSI 2.5-2/2X2AN/G20/LD1 ZSI 2.5-2/2X2AN/G20/LD2 ZSI 6-2 2X2.5/G20 ZSI 6-2 2X2.5/G20/LD1 ZSI 6-2 2X2.5/G20/LD2 ZSI 6-2 2X2.5/G20/LD3 ZSI 6-2 2X2.5/G20/LD4 ZSI 6-2/FC ZDU 2.5/2X2AN/D- ZSI 6-2/FC LD ZDU 4 ZDU 4 BL ZDU 4/3AN ZDU 4/3AN BL ZDU 4/4AN ZDU 4/4AN BL ZEI 16
Width				
ZAD 3/4		20	1609120000	ZDU 2.5/2X2AN/D+ ZDU 2.5/2X2AN/D- ZDU 6 ZDU 6 BL ZDU 6/3AN ZDU 6/3AN BL ZEI 16 ZEI 16 BL ZEI 6
Width				
ZAD 4/5		20	1746730000	ZDU 10 ZDU 10 BL ZDU 10/3AN ZDU 10/3AN BL ZDU 2.5/2X2AN/D+ ZDU 2.5/2X2AN/D- ZEI 16 ZEI 16 BL
Width				
ZAD 5/5		20	1745210000	ZDU 16 ZEI 16-2/1AN BL ZDU 16 BL ZDU 16/3AN ZDU 16/3AN BL ZDU 2.5/2X2AN/D+ ZDU 2.5/2X2AN/D- ZEI 16 ZEI 16 BL ZEI 16-2/1AN

Cover

Type	Colour	Qty.	Order No.	For terminal:
ZAD 6/5		20	1752620000	ZDU 2.5/2X2AN/D+ ZDU 2.5/2X2AN/D- ZDU 35 ZDU 35 BL ZEI 16 ZEI 16 BL
Width				
ZAD 9/4		20	1934160000	ZDU 2.5N ZDU 2.5N/3AN ZDU 2.5N/4AN ZDK 2.5 ZDK 2.5/3AN ZDK 2.5V ZDUA 2.5-2 ZPEA 2.5-2

Operating tool

Type	Colour	Qty.	Order No.	For terminal:
ZBW 1/3.5		1	1781930000	ZDK 1.5DU-PE ZDK 2.5-2 ZDK 2.5-2 BL ZDK 2.5-2 PE ZDK 2.5V ZDK 2.5V BL ZDKPE 2.5-2 ZDKPE 2.5-2/N/L/PE
Width				
ZBW 1		1	1669620000	ZDK 2.5-2
ZBW 2		1	1650670000	ZDK 2.5-2 BL
ZBW 3		1	1650680000	ZDK 2.5-2 PE
ZBW 4		1	1650690000	ZDK 2.5V
ZBW-6		1	1650700000	ZDK 2.5V BL
ZBWW		1	1669630000	ZDKPE 2.5-2 ZDKPE 2.5-2/N/L/PE

Accessories – Other functions

Reducing sleeves

The use of reducing sleeves simplifies the connection of conductors with smaller cross-sections. Conductors can be reliably inserted into the clamping point without the strands fraying. The use of a reducing sleeve centres the conductor in the entry point.

Packaged in sets of 100 x 10-pole strips

Technical data	
Product type	
Ordering data	
	0.13...0.2 mm ² , white
	0.25...0.5 mm ² , grey
	0.75...1.0 mm ² , dark grey

ZRH 1.5 S



Reducing sleeve		
Type	Qty.	Order No.
ZRH 1.5S/1	500	1781950000
ZRH 1.5S/2	500	1781960000

For terminal:		
ZDU 1.5/...		
ZPE 1.5/...		

ZRH 1.5 H



Reducing sleeve		
Type	Qty.	Order No.
ZRH 1.5H/1	1000	1678810000
ZRH 1.5H/2	1000	1678800000

For terminal:		
ZDK 2.5...	ZDL 2.5-2...	
ZDK 2.5 PE	ZDU 2.5-2/...	
ZDTR 2.5	ZPE 2.5-2/...	
	ZTR 2.5-2...	

ZRH 1.5 N



Reducing sleeve		
Type	Qty.	Order No.
ZRH 1.5N/1	1000	1632140000
ZRH 1.5N/2	1000	1632130000

For terminal:		
ZRV 1.5		
ZRV 1.5 PEZVL 1.5		
ZIA 1.5/3 L ...		
ZIA 1.5/4 L ...		

ZRH 2.5



Reducing sleeve		
Type	Qty.	Order No.
ZRH 2.5/1 WS	1000	1614300000
ZRH 2.5/2 GR/VO	1000	1614290000
ZRH 2.5/3	1000	1614280000

For terminal:		
ZDU 2.5/...		
ZTR 2.5/...		

ZRH 4



Reducing sleeve		
Type	Qty.	Order No.
ZRH 4/1 WS	1000	1636640000
ZRH 4/2	1000	1636650000

For terminal:		
ZDU 4/...		
ZPE 4/...		

Label

The **BZT** marking tags enable you to label the middle of the marking channel with the **WS 10/5** tags. The marking tags can be put together with pins in order to achieve the greatest degree of stability.

Technical data	
Product type	
Ordering data	
	One-sided, without peg
	One-sided, with peg
	Two-sided without pin
	Two-sided, with pin

BZT 1/BZT 2



Marker holder		
Type	Qty.	Order No.
BZT 1 WS 10/5	100	1805490000
BZT 1 ZA WS 10/5	100	1805520000
BZT 2 WS 10/5	100	1805480000
BZT 2 ZA WS 10/5	100	1805530000

For terminal:		
ZDU 2.5/...		
ZDU 4/...		
ZDU 6/...		
ZDU A 2.5/...		

Additional connection

The contact element is placed in the cross-section channel and the latch clip in the screwdriver channel. It should then be pressed down until the end stop. The pitch spacing is 6 mm. Therefore only every other terminal can be occupied.

Dimensions	
Width / Length / Height	mm
Stripping length	mm
Rated data	
Rated voltage	V
Rated current	A
Rated cross-section	mm ²
Rated impulse voltage	kV
Pollution severity	
Ordering data	
	With snap-in pegs

ZZA 2.5



Dimensions		
Width / Length / Height	mm	6.1 / 21 / 23 (50)
Stripping length	mm	
Rated data		
Rated voltage	V	400
Rated current	A	17.5
Rated cross-section	mm ²	2.5
Rated impulse voltage	kV	6
Pollution severity		3
Ordering data		
Type	Qty.	Order No.
ZZA 2.5/ZA	50	1649350000
ZZA 2.5	50	1646690000
For terminal:		
ZDU 2.5		
ZDU 2.5/3 AN		
ZDU 2.5/4 AN		
ZTR 2.5		
ZTR 2.5/3 AN		

Component plug

The component plug is used for fitting electronic components. If needed, the BZS 1 can be snapped on to the upper or lower cross-connection channel on the ZDK 2.5 tension-clamp terminals.

Dimensions	
Width / Length / Height	mm
Stripping length	mm
Rated data	
Rated voltage	V
Rated voltage with LED	30 V
Rated current	A
Rated current with LED	1 A
Rated impulse voltage	kV
Pollution severity	
Ordering data	
	For holding 2 LEDs

ZBS



Dimensions		
Width / Length / Height	mm	10 / 22.3 / 48
Stripping length	mm	
Rated data		
Rated voltage	V	250
Rated voltage with LED		30 V
Rated current	A	6
Rated current with LED		1 A
Rated impulse voltage	kV	4
Pollution severity		3
Ordering data		
Type	Qty.	Order No.
ZBS1 F.D SET	10	1764550000
For terminal:		
ZDK 2.5		

Shield conductor

The shielding braid from the stripped control cables is soldered to the ZDUS or crimped on with 2.8 x 0.8 mm cable-lug sleeves. The ZDUS can be installed along side of the ZDU 2.5, ZDU 2.5/3 AN, ZDU 4, ZDU 6 and ZTR 2.5.

Dimensions	
Width / Length / Height	mm
Ordering data	

ZDUS

Shield conductor - connection terminals



Dimensions		
Width / Length / Height	mm	4.8 / 83.5 / 33.5
Ordering data		
Type	Qty.	Order No.
ZDUS	20	1676640000
For terminal:		

SIHA fuse holder

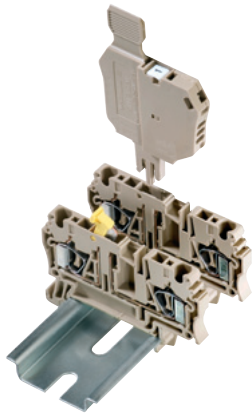

For 5 x 20 G-fuse cartridges

The SIHA fuse holder converts a simple disconnect terminal into a fuse terminal in next to no time. Simply remove the isolating lever and insert the fuse plug.

- Simple handling - no tools required
- Housing made of Wemid (VO)
- Rated current 6.3 A
- 1.6 W power loss to DIN VDE 0611-6 at 23 °C ambient temperature (also for 1.5 times rated current - composite arrangement)

- Even fits on 5 mm wide terminals when fitted in offset arrangement



- Marking position for Dekafix 5 and space for the E-Fix self-adhesive label, size 8/20



1. Open fuse holder with fingers or screwdriver.



2. Press out old fuse.

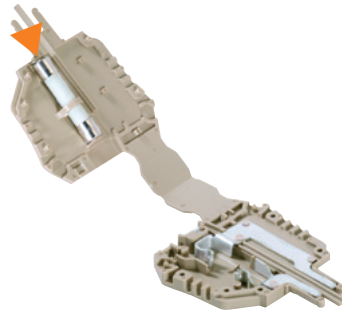

3. Position new fuse.



4. Press fuse holder together again with fingers or screwdriver.

SIHA 3



	Qty.	Order No.
without LED		
SIHA3/G20	400 V 1	7921560000
with LED (red)		
SIHA3/G20	10 - 36 V 1	7921570000
	35 - 70 V 1	7921580000
	60 - 150 V 1	7921590000
	140 - 250 V 1	7921600000
For test-disconnect terminals versions		
ZTR 2.5/4 AN		
ZTR 2.5...		
ZTR 2.5-2		

SIHA STRAP

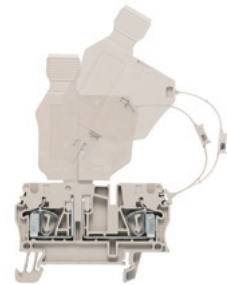

	Qty.	Order No.
with strap		
SIHA STRAP	20	9537680000

Connector for "retro-fit" assembly

- Receptacle in the terminal is the marking position
- Integrated marking position on the strap
- Slots into fuse holder either on the left or on the right

ZST 1 fuse-carrier / ZST multi-carrier



ZST 1

The ZST 1 fuse-carrier can hold 6 device fuses (5 x 20 or 5 x 25 mm) which are available to be used during servicing work.



Dimensions		
Width / Length / Height	mm	8 / 62 / 40

Ordering data

Type	Qty.	Order No.
ZST 1	25	1269070000

ZST

The ZST group carrier is used for temporary „parking“ of test plugs, cross-connections and fuses which are used during service work. The group carrier can be snapped on to the end of a terminal strip or to the TS 35 rail.

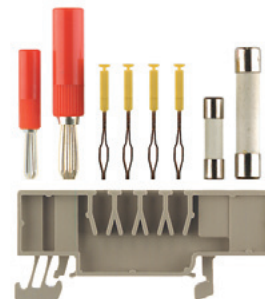

Dimensions		
Width / Length / Height	mm	10 / 61.1 / 27.5

Ordering data

Type	Qty.	Order No.
ZST	10	1678680000

Component isolating plugs

The Weidmüller philosophy is to realise a multitude of applications with just a few parts. The component and isolating plugs (BEST and TNST) represent a logical extension of this cost-effective and efficient approach. The component plug can accommodate electronic components and connect them to the terminal. And once an isolating plug is removed, the clamping point is obviously disconnected. The opening is easy to recognise.

An unintentional reconnection of the circuit is prevented by simply removing the isolating plug. The BEST and the TNST have the same pin arrangement. Both plugs are also identical with the SIHA 3 fuse holder, meaning that they can be used in all the “disconnecting products” of the W-, Z-, I- and P-Series.

Component plug (up to 250 V)

can be reversed

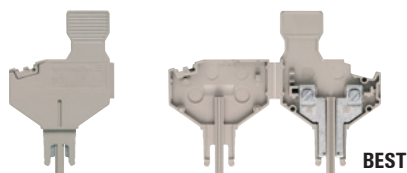

Ordering data

Type	Fitted with...	Qty.	Order No.
BEST	-	25	1833100000
BEST/DRBR	wire jumper	25	1878570000
BEST/D	diode 1N4007	25	1878560000

For terminal type
 PTR 2.5/4...
 PDL 4 TR/...

Isolating plug

Isolating plug



Ordering data

Type	Colour	Qty.	Order No.
TNST	yellow Wemid	25	1833090000

For terminal type
 ZTR 2.5...
 ZTR 2.5-2
 ZDL 2.5/TR
 ZDL 2.5/SI

Colour range

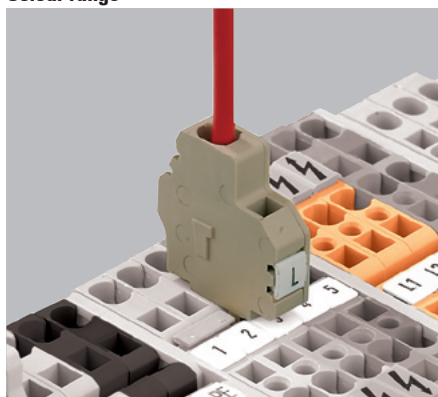

The colours listed below are available as standard. Other variants are available upon request and are subject to minimum order quantities.

				1.5 mm ²
ZDU 1.5	Colour	Qty.	Order No.	
ZDU 1.5 BL	blue	100	1775490000	
ZDU 1.5 OR	orange	100	1775500000	
ZDU 1.5/2X2AN				
ZDU 1.5/2X2AN BL	blue	100	1826990000	
ZDU 1.5/2X2AN OR	orange	100	1827000000	
ZDU 1.5/3AN				
ZDU 1.5/3AN BL	blue	100	1775540000	
ZDU 1.5/3AN OR	orange	100	1775550000	
ZDU 1.5/4AN				
ZDU 1.5/4AN BL	blue	100	1775600000	
ZDU 1.5/4AN OR	orange	100	1775610000	

				2.5 mm ²
ZDU 2.5	Colour	Qty.	Order No.	
ZDU 2.5 BL	blue	100	1608520000	
ZDU 2.5 BR	braun	100	1683300000	
ZDU 2.5 GE	yellow	100	1683270000	
ZDU 2.5 GE/GN	yellow/green	100	1698780000	
ZDU 2.5 GN	green	100	1683280000	
ZDU 2.5 GR	grey	100	1683310000	
ZDU 2.5 OR	orange	100	1636780000	
ZDU 2.5 RT	red	100	1683260000	
ZDU 2.5 SW	black	100	1683330000	
ZDU 2.5 VI	violet	100	1683290000	
ZDU 2.5 WS	white	100	1683320000	

				ZDU 2.5/2X2
ZDU 2.5/2X2AN BL	blue			1608610000
ZDU 2.5/2X2AN OR	orange			1636810000

				ZDU 2.5/3AN
ZDU 2.5/3AN BL	blue	100		1608550000
ZDU 2.5/3AN GE	yellow	100		1683350000
ZDU 2.5/3AN GE/GN	yellow/green	100		1698790000
ZDU 2.5/3AN GN	green	100		1683360000
ZDU 2.5/3AN GR	grey	100		1683390000
ZDU 2.5/3AN OR	orange	100		1636790000
ZDU 2.5/3AN RT	red	100		1683340000
ZDU 2.5/3AN SW	black	100		1683410000
ZDU 2.5/3AN WS	white	100		1683400000

				ZDU 2.5/4AN
ZDU 2.5/4AN BL	blue			1608580000
ZDU 2.5/4AN BR	braun	100		1683460000
ZDU 2.5/4AN GE	yellow	100		1683430000
ZDU 2.5/4AN GE/GN	yellow/green	100		1692240000
ZDU 2.5/4AN GN	green	100		1683440000
ZDU 2.5/4AN GR	grey	100		1683470000
ZDU 2.5/4AN OR	orange	100		1636800000
ZDU 2.5/4AN RT	red	100		1683420000
ZDU 2.5/4AN SW	black	100		1683490000
ZDU 2.5/4AN WS	white	100		1683480000

				ZDU 2.5 2X2AN
ZDU 2.5 2X2AN				1608600000

				ZDU 2.5-2
ZDU 2.5-2 BL	blue			1772070000
ZDU 2.5-2 OR	orange	100		1772080000

				ZDU 2.5-2/3AN
ZDU 2.5-2/3AN BL	blue			1706040000
ZDU 2.5-2/3AN GE	yellow			1946240000
ZDU 2.5-2/3AN OR	orange	100		1706050000
ZDU 2.5-2/3AN RT	red			1946220000
ZDU 2.5-2/3AN SW	black			1946210000
ZDU 2.5-2/3AN WS	white			1946230000

				ZDU 2.5-2/4AN
ZDU 2.5-2/4AN BL	blue			1706070000
ZDU 2.5-2/4AN OR	orange	100		1706080000

				ZTR 2.5
ZTR 2.5 OR	orange	100		8731680000

				ZTR 2.5/3AN
ZTR 2.5/3AN OR	orange	50		8731690000

				ZTR 2.5/4AN
ZTR 2.5/4AN OR	orange	100		7920940000

				ZTR 2.5-2
ZTR 2.5-2 OR	orange	100		1779130000

				ZDK 2.5
ZDK 2.5 OR	orange	50		1694140000

				ZDK 2.5-2
ZDK 2.5-2 OR	orange	50		1831260000

4 mm ²			
	Colour	Qty.	Order No.
ZDU 4			
ZDU 4 BL	blue		1632060000
ZDU 4 BR	braun	100	1683620000
ZDU 4 GE	yellow	100	1683590000
ZDU 4 GE/GN	yellow/green	100	1698770000
ZDU 4 GR	grey	100	1683630000
ZDU 4 OR	orange	100	1636830000
ZDU 4 RT	red	100	1683580000
ZDU 4 SW	black	100	1683650000
ZDU 4 WS	white	100	1683640000
ZDU 4/3AN			
ZDU 4/3AN BL	blue		7904190000
ZDU 4/4AN OR	orange		8670210000
ZDU 4-2/2AN			
ZDU 4-2/2AN BL	blue		1770840000
ZDU 4-2/3AN			
ZDU 4-2/3AN BL	blue		1770860000
ZDU 4-2/3AN OR	orange	100	1770870000

6 mm ²			
	Colour	Qty.	Order No.
ZDU 6			
ZDU 6 BL	blue		1608630000
ZDU 6 OR	orange	50	1636820000
ZDU 6 RT	red	50	1830420000
ZDU 6/3AN			
ZDU 6/3AN BL	blue		7907420000
ZDU 6/3AN OR	orange		8670420000
ZDU 6-2/2AN			
ZDU 6-2/2AN BL	blue		1771390000
ZDU 6-2/2AN OR	orange	50	1771400000
ZDU 6-2/3AN			
ZDU 6-2/3AN BL	blue		1771420000
ZDU 6-2/3AN OR	orange	50	1771430000

10 mm ²			
	Colour	Qty.	Order No.
ZDU 10			
ZDU 10 BL	blue		1746760000
ZDU 10 OR	orange	25	1830610000
ZDU 10/3AN			
ZDU 10/3AN BL	blue		1767700000

16 mm ²			
	Colour	Qty.	Order No.
ZDU 16			
ZDU 16 BL	blue		1745240000
ZDU 16 OR	orange	25	1830680000
ZDU 16 SW	black		1830650000
ZDU 16/3AN			
ZDU 16/3AN BL	blue		1768330000

35 mm ²			
	Colour	Qty.	Order No.
ZDU 35			
ZDU 35 BL	blue		1739630000
ZDU 35 OR	orange	10	1830760000

Mini terminals				2.5 mm ²	
	Colour	Qty.	Order No.		
ZDUA 2.5-2					
ZDUA 2.5-2 BL	blue		1808180000		
ZDUA 2.5-2 OR	orange	100	1720940000		
ZDUA 2.5-2N BL	blue		1808180000		
ZDUB 2.5-2/2AN					
ZDUB 2.5-2/2AN/DB BL	blue		1704510000		
ZDUB 2.5-2/2AN/DB GE	yellow		1704530000		
ZDUB 2.5-2/2AN/DM BL	blue		1704360000		
ZDUB 2.5-2/2AN/DM GE	yellow		1704380000		
ZDUB 2.5-2/2AN/DM OR	orange	100	1704370000		
ZDUB 2.5-2/4AN					
ZDUB 2.5-2/4AN/DB BL	blue		1704700000		
ZDUB 2.5-2/4AN/DB GE	yellow		1704720000		
ZDUB 2.5-2/4AN/DM BL	blue		1704550000		
ZDUB 2.5-2/4AN/DM GE	yellow		1704570000		
ZDUB 2.5-2/4AN/DM OR	orange	100	1704560000		

Terminals, W-Series

Terminals, W-Series	Overview W-Series	D.2
	Feed-through terminals	D.4
	Double-level terminals	D. 16
	PE terminals	D. 22
	Fuse terminals	D. 32
	Test-disconnect terminals	D. 54
	Earth wire disconnect terminals	D. 77
	Installation terminals	D. 78
	Terminals with spring-loaded cable clamps	D. 86
	Initiator and actuator terminals	D. 92
	Motor connection terminals	D. 96
	Plug-in modular terminals	D. 98
	Multi-functional terminals	D. 104
	Terminals for temperature measuring circuits	D. 114
	Terminals for retrofitting of electronic components	D. 115
	Terminals with electronic components	D. 116
Power distribution blocks WPDB	D. 122	
Terminals, TS 15	Mini terminals TS 15	D. 130
Terminals for direct mounting	Multi-pole terminal strips for direct mounting	D. 134
Stud terminals	Overview Stud terminals	D. 140
	Overview Stud terminals – ST 4000	D. 142
	Single-/twin stud terminals – WF/WFF	D. 144
	Twin stud terminals – ST 4000	D. 152
Accessories	Accessories W-Series	D. 154
Terminals, SAK-Series	Overview SAK-Series	D. 184

Terminal blocks with clamping yoke and screw connection system

High contact reliability for all standard electrical functions

For a long time now, Weidmüller's W-Series terminal with screw clamp connection technology, has set the standard.

The W-Series offers solutions for conductor cross-sections between 0.05 and 300 mm². The cross-connectors are pluggable (ZQV) or screwable (WQV) in a terminal block. The combination of benefits is unequalled and puts the W-Series in a leading position on the market.

D

Thanks to the patented design of Weidmüller's W-Series screw connection technology, it is possible for two conductors of the same cross-section to be connected in one and the same clamping point without difficulty.

Designs

The W-Series is offered in standard and compact designs. The compact design is impressive with its small size for the design cross-sectional capacity.

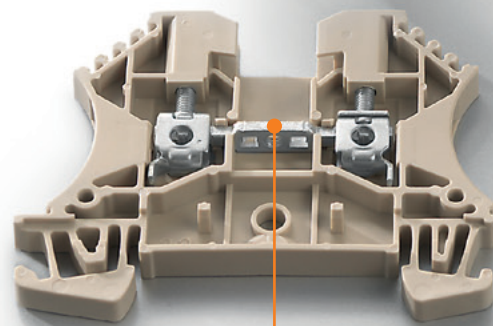
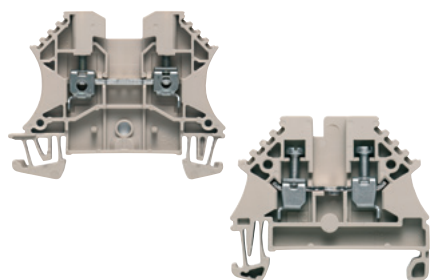
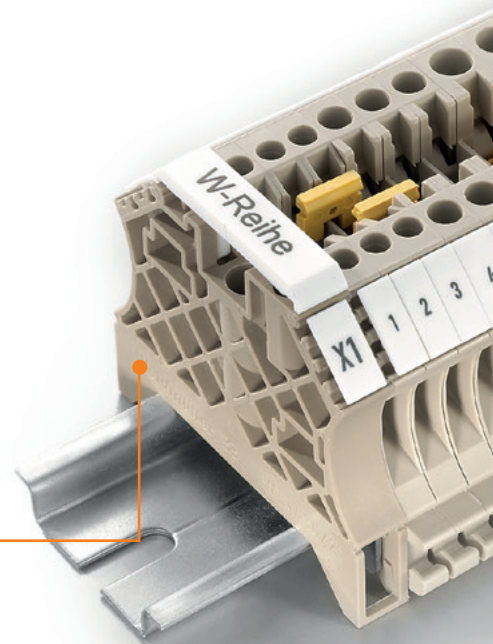

Connections proven a million times

The terminal unit consists of hardened steel, for very high contact force. The busbar is made of copper, which gives a low voltage drop. The tin-plated surface ensures minimum contact resistances.

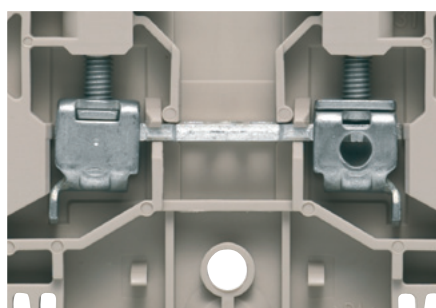

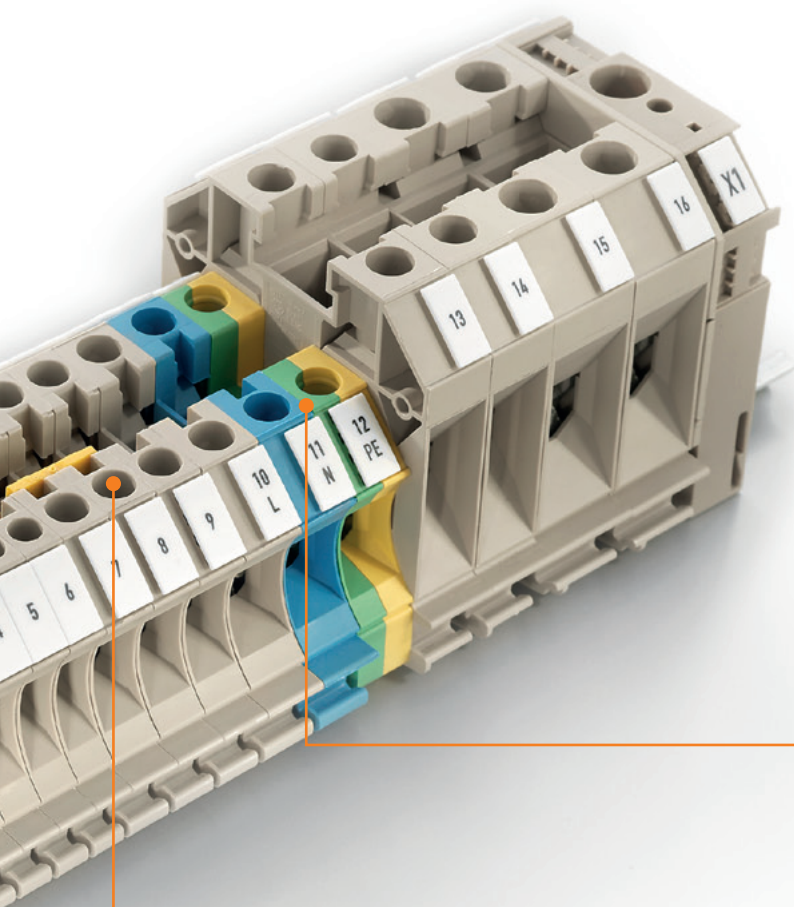

Efficiency thanks to equal contours

Uniform size of the terminal block bodies from 2.5 to 10 mm² means fewer accessories, lowers the cost, offers logistical advantages and enables simple installation.

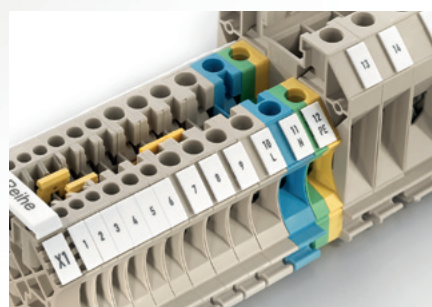

Safe operation

The terminal blocks are supplied with open clamping units, this enables quick assembly. In addition, the misplugging safeguard prevents conductors from being inserted incorrectly. Embossing on the clamping yoke and current bar engage so that even the smallest conductors are reliably contacted; large conductors and also 2 conductors are gripped in the middle.

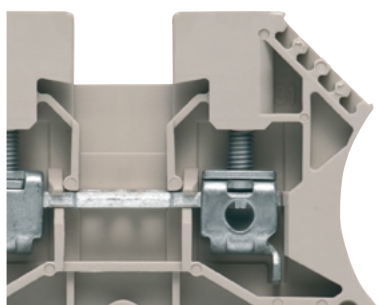

Feed-through terminals

Identically contoured design of 2.5 to 10 mm² with identical end plates and partitions. An unmatched combination of many advantages!

The compact terminals are impressive for their small size and rated cross-section capacity.

In hazardous area applications, the installation instructions and the rated data specifications for accessories given in the technical appendix must be followed.

Width/Length/Height of lowest version	mm
max. current / max. cond. cross-section	A/mm ²
Max. clamping range	mm ²

Technical data

Rated data	
Rated voltage	V
Rated current	A
Rated cross-section	mm ²
Rated impulse withstand voltage / Pollution severity Gauge to IEC 60947-1 / Flammability class UL94	
Approvals	
Clamped conductors (H05V/H07V)	
Solid / stranded	mm ²
Flexible / Flexible with ferrule	mm ²
Tightening torque range (terminal screw)	
Stripping length / Blade size	mm/-
2 conductors with same cross-section (H05V/H07V)	
Solid / stranded	mm ²
Flexible / Flexible with ferrule	mm ²
Note	

Ordering data

Version	
	Dark beige Wemid
	Blue Wemid
Note	

Accessories

Pluggable cross-connection	
	2-pole
	3-pole
	4-pole
	10-pole
	20-/24-pole
Screwable cross-connection	
	2-pole
	3-pole
	4-pole
	10-pole
End plate / Partition plate	
	Dark beige Wemid
	Blue Wemid
	Dark beige Wemid
	Blue Wemid
End bracket	
	Dark beige Wemid
	Dark beige Wemid
Testing / Checking	
	Standard
	With assembly peg
Cover	
	With lightning flash symbol
	Blank, white
	Blank, yellow
Identification systems (see assortment in catalogue 7)	
	Marking tags
Note	

WDU 1.5/ZZ

1.5 mm²

Twin connection

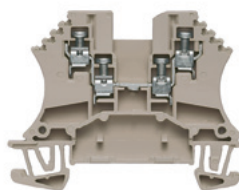

5.1 x 60 x 47
23 / 2.5
0.13...2.5

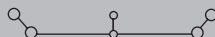

IEC 60947-7-1

Ex e II II 2 G D

IEC	UL	CSA	EN 60079-7
800	300 (C)	300 (C)	550
17.5	25 (C)	10 (C)	15
1.5	AWG 22...12	AWG 26...12	1.5
8 kV / 3			
A1 / V-0			

KEMA 98ATEX1685 U

Rated connection	Further connection
0.5...2.5 / 0.5...2.5	0.5...2.5
0.5...1.5 / 0.5...1.5	0.5...1.5 / 0.5...1.5
0.4...0.6 Nm (M 2.5)	
7 / 0.6 x 3.5 mm	
0.5...1	
0.5...1 / 0.5...0.75	

Note the max. current of the terminal (23 A) when using the WQV cross-connector!

Type	Qty.	Order No.
WDU 1.5/ZZ	100	1031400000
WDU 1.5/ZZ BL	100	1031480000

Type	current	Qty.	Order No.
ZQV 2.5N/2 GE	24 A	60	1693800000
ZQV 2.5N/3 GE	24 A	60	1693810000
ZQV 2.5N/4 GE	24 A	60	1693820000
ZQV 2.5N/10 GE	24 A	20	1693880000
ZQV 2.5N/20 GE	24 A	20	1909000000
Width			
WQV 2.5/2	32 A	50	1053660000
WQV 2.5/3	32 A	50	1053760000
WQV 2.5/4	32 A	50	1053860000
WQV 2.5/10	32 A	20	1054460000

Type	Width	Qty.	Order No.
WAP 2.5-10	1.5 mm	50	1050000000
WAP 2.5-10 BL	1.5 mm	50	1050080000
WAP 16+35 WTW 2.5-10	1.5 mm	20	1050100000
WAP 16+35 WTW 2.5-10 BL	1.5 mm	20	1050180000
Width			
WEW 35/2	8 mm	100	1061200000
Width			
WTA 2 WDU2.5-10	5 mm	25	1632320000
WTA 2/ZA WDU2.5-10	5 mm	25	1632330000
Width			
WAD 4 GE BED	4.5 mm	50	1072000000
WAD 4 WS	4.5 mm	50	1072100000

DEK 5/5 / WS 12/5

Socket and test plug, see section "W-Series accessories".

WDU 2.5/1.5/ZR

2.5 mm²

Supplementary connection, right

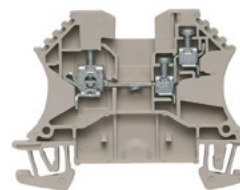

5.1 x 60 x 47
32 / 4
0.05...4

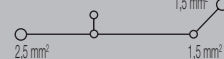

IEC 60947-7-1

Ex e II II 2 G D

IEC	UL	CSA	EN 60079-7
800	300 (C)	300 (C)	550
24	20 (C)	20 (C)	21
2.5	AWG 30...12	AWG 26...14	2.5
8 kV / 3			
A3, A1 / V-0			

KEMA 98ATEX1685 U

Rated connection	Further connection
0.5...4 / 1.5...4	0.5...4
0.5...4 / 0.5...2.5	0.5...0.5 / 0.5...2.5
0.4...0.6 Nm (M 2.5)	
10 / 0.6 x 3.5 mm	
0.5...1	
0.5...1.5 / 0.5...1.5	

2.5 mm² wires with wire ferrules including the plastic collar only clampable with diameter-optimised collar (Order no. 1333100000, pack of 500).

Type	Qty.	Order No.
WDU 2.5/1.5/ZR	100	1024700000
WDU 2.5/1.5/ZR BL	100	1024780000

The rated voltage is 400 V when using ZQV cross-connection, additional connection (right 1.5 mm²).

Type	current	Qty.	Order No.
ZQV 2.5N/2 GE	24 A	60	1693800000
ZQV 2.5N/3 GE	24 A	60	1693810000
ZQV 2.5N/4 GE	24 A	60	1693820000
ZQV 2.5N/10 GE	24 A	20	1693880000
ZQV 2.5N/20 GE	24 A	20	1909000000
Width			
WQV 2.5/2	32 A	50	1053660000
WQV 2.5/3	32 A	50	1053760000
WQV 2.5/4	32 A	50	1053860000
WQV 2.5/10	32 A	20	1054460000

Type	Width	Qty.	Order No.
WAP 2.5-10	1.5 mm	50	1050000000
WAP 2.5-10 BL	1.5 mm	50	1050080000
WAP 16+35 WTW 2.5-10	1.5 mm	20	1050100000
WAP 16+35 WTW 2.5-10 BL	1.5 mm	20	1050180000
Width			
WEW 35/2	8 mm	100	1061200000
Width			
WTA 2 WDU2.5-10	5 mm	25	1632320000
WTA 2/ZA WDU2.5-10	5 mm	25	1632330000
Width			
WAD 4 GE BED	4.5 mm	50	1072000000
WAD 4 WS	4.5 mm	50	1072100000

DEK 5/5 / WS 12/5

Use a 2.5 / 1 mm² conductor when using the WQB.

WDU 2.5 **2.5 mm²**

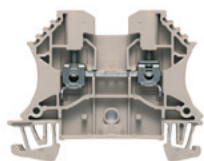

5.1 x 60 x 47
32 / 4
0.05...4



IEC 60947-7-1 Ex e II II 2 G D

IEC	UL	CSA	EN 60079-7
800	600 (C)	600 (C)	550
24	25 (C)	20 (C)	21
2.5	AWG 30...12	AWG 26...12	2.5

8 kV / 3
 A3 / V-0

KEMA 98ATEX1683 U

Rated connection	Further connection
0.5...4 / 1.5...4	
0.5...4 / 0.5...2.5	
0.4...0.6 Nm (M 2.5)	
10 / 0.6 x 3.5 mm	

0.5...1.5
 0.5...1.5 / 0.5...1.5

2.5 mm² wires with wire ferrules including the plastic collar only clampable with diameter-optimised collar (Order no. 1333100000, pack of 500).

Type	Qty.	Order No.
WDU 2.5	100	1020000000
WDU 2.5 BL	100	1020080000

Rated voltage is 400 V when using cross-connection ZQV
 Refer to the W-Series Accessories section for colour versions.

Type	current	Qty.	Order No.
ZQV 2.5N/2 GE	24 A	60	1693800000
ZQV 2.5N/3 GE	24 A	60	1693810000
ZQV 2.5N/4 GE	24 A	60	1693820000
ZQV 2.5N/10 GE	24 A	20	1693880000
ZQV 2.5N/20 GE	24 A	20	1909000000
Width			
WQV 2.5/2	32 A	50	1053660000
WQV 2.5/3	32 A	50	1053760000
WQV 2.5/4	32 A	50	1053860000
WQV 2.5/10	32 A	20	1054460000
Width			
WAP 2.5-10	1.5 mm	50	1050000000
WAP 2.5-10 BL	1.5 mm	50	1050080000
WAP 16+35 WTW 2.5-10	1.5 mm	20	1050100000
WAP 16+35 WTW 2.5-10 BL	1.5 mm	20	1050180000
Width			
WEW 35/2	8 mm	100	1061200000
Width			
WTA 2 WDU2.5-10	5 mm	25	1632320000
WTA 2/ZA WDU2.5-10	5 mm	25	1632330000
Width			
WAD 5 MC NE WS	5 mm	48	1112910000
WAD 5 MC NE GE	5 mm	48	1112920000

DEK 5/5 / WS 12/5

Ensure 2.5 mm² max. when using the WQB. Only 400 V when using the shielding rail LS 2,8 1056400000.

WDU 2.5N **2.5 mm²**

With screwable cross-connection
 Compact design

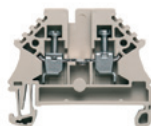

5.1 x 44 x 37.5
32 / 4
0.05...4

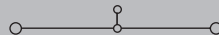

IEC 60947-7-1 Ex e II II 2 G D

IEC	UL	CSA	EN 60079-7
500	300 (D)	300 (D)	440
24	10 (D)	10 (D)	21
2.5	AWG 22...12	AWG 26...12	2.5

6 kV / 3
 A3 / V-0

KEMA 98ATEX1683 U

Rated connection	Further connection
0.5...4 / 1.5...4	
0.5...4 / 0.5...2.5	
0.4...0.6 Nm (M 2.5)	
10 / 0.6 x 3.5 mm	

0.5...1.5
 0.5...1.5 / 0.5...1.5

2.5 mm² wires with wire ferrules including the plastic collar only clampable with diameter-optimised collar (Order no. 1333100000, pack of 500).

Type	Qty.	Order No.
WDU 2.5N	100	1023700000
WDU 2.5N BL	100	1023780000

Colour variants listed under the W-Series accessories section, "Specific functions".

Type	current	Qty.	Order No.
WQV 2.5/2	32 A	50	1053660000
WQV 2.5/3	32 A	50	1053760000
WQV 2.5/4	32 A	50	1053860000
WQV 2.5/10	32 A	20	1054460000
Width			
WAP WDU2.5N/4N	1.5 mm	50	1060000000
WAP WDU2.5N/4N BL	1.5 mm	50	1060080000
Width			
EW 35	8.5 mm	50	0383560000
Width			
WTA 1 WDU1.5	5 mm	25	1632290000
WTA 1/ZA WDU1.5	5 mm	25	1632300000
Width			
WAD 4 GE BED	4.5 mm	50	1072000000
WAD 4 WS	4.5 mm	50	1072100000

DEK 5/5 / WS 12/5

Socket and test plug, see section "W-Series accessories".

WDU 2.5N/ZQV **2.5 mm²**

With pluggable cross-connection
 Compact design

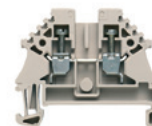

5.1 x 44 x 37.5
32 / 4
0.05...4

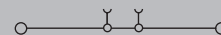

IEC 60947-7-1

IEC	UL	CSA
500	600 (C)	300 (C)
24	25 (C)	25 (C)
2.5	AWG 22...12	AWG 26...12

6 kV / 3
 A3 / V-0

Rated connection	Further connection
0.5...4 / 1.5...4	
0.5...4 / 0.5...2.5	
0.4...0.6 Nm (M 2.5)	
10 / 0.6 x 3.5 mm	

0.5...1.5
 0.5...1.5 / 0.5...1.5

2.5 mm² wires with wire ferrules including the plastic collar only clampable with diameter-optimised collar (Order no. 1333100000, pack of 500).

Type	Qty.	Order No.
WDU 2.5N ZQV	100	1040800000
WDU 2.5N ZQV BL	100	1040880000

Rated voltage is 400 V when using the ZQV cross-connector.

Type	current	Qty.	Order No.
ZQV 2.5N/2 GE	24 A	60	1693800000
ZQV 2.5N/3 GE	24 A	60	1693810000
ZQV 2.5N/4 GE	24 A	60	1693820000
ZQV 2.5N/10 GE	24 A	20	1693880000
ZQV 2.5N/20 GE	24 A	20	1909000000
Width			
WAP WDU2.5N/4N	1.5 mm	50	1060000000
WAP WDU2.5N/4N BL	1.5 mm	50	1060080000
Width			
EW 35	8.5 mm	50	0383560000
Width			
WTA 1 WDU1.5	5 mm	25	1632290000
WTA 1/ZA WDU1.5	5 mm	25	1632300000
Width			
WAD 4 GE BED	4.5 mm	50	1072000000
WAD 4 WS	4.5 mm	50	1072100000

DEK 5/5 / WS 12/5

Feed-through terminals

Identically contoured design of 2.5 to 10 mm² with identical end plates and partitions. An unmatched combination of many advantages!

The compact terminals are impressive for their small size and rated cross-section capacity.

In hazardous area applications, the installation instructions and the rated data specifications for accessories given in the technical appendix must be followed.

Width/Length/Height of lowest version	mm
max. current / max. cond. cross-section	A/mm ²
Max. clamping range	mm ²

Technical data

Rated data	
Rated voltage	V
Rated current	A
Rated cross-section	mm ²
Rated impulse withstand voltage / Pollution severity Gauge to IEC 60947-1 / Flammability class UL94	
Approvals	
Clamped conductors (H05V/H07V)	
Solid / stranded	mm ²
Flexible / Flexible with ferrule	mm ²
Tightening torque range (terminal screw)	
Stripping length / Blade size	mm/-
2 conductors with same cross-section (H05V/H07V)	
Solid / stranded	mm ²
Flexible / Flexible with ferrule	mm ²
Note	

Ordering data

Version	
	Dark beige Wemid
	Blue Wemid
Note	

Accessories

Pluggable cross-connection	
	2-pole
	3-pole
	4-pole
	10-pole
	20-/24-pole
Screwable cross-connection	
	2-pole
	3-pole
	4-pole
	10-pole
End plate / Partition plate	
	Dark beige Wemid
	Blue Wemid
	Dark beige Wemid
	Blue Wemid
End bracket	
	Dark beige Wemid
	Dark beige Wemid
Testing / Checking	
	Standard
	With assembly peg
Cover	
	With lightning flash symbol
	Blank, white
	Blank, yellow
Identification systems	
	(see assortment in catalogue 7)
	Marking tags
Note	

WDU 2.5N/600 UL

2.5 mm²

600V UL/CSA

Compact design

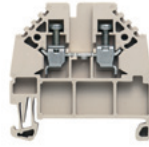

5.1 x 44 x 43.5
32 / 4
0.05...4

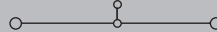

IEC 60947-7-1

IEC	UL	CSA
800	600 (C)	600 (C)
24	25 (C)	20 (C)
2.5	AWG 22...12	AWG 26...12
8 kV / 3		
A3 / V-0		



Rated connection	Further connection
0.5...4 / 1.5...4	
0.5...4 / 0.5...2.5	
0.4...0.6 Nm (M 2.5)	
10 / 0.6 x 3.5 mm	
0.5...1.5	
0.5...1.5 / 0.5...1.5	
2.5 mm ² wires with wire ferrules including the plastic collar only clampable with diameter-optimised collar (Order no. 1333100000, pack of 500).	

Type	Qty.	Order No.
WDU 2.5N/600UL	100	1730940000

Type	current	Qty.	Order No.
WQV 2.5/2	32 A	50	1053660000
WQV 2.5/3	32 A	50	1053760000
WQV 2.5/4	32 A	50	1053860000
WQV 2.5/10	32 A	20	1054460000
Width			
WAP WDU2.5N/4N	1.5 mm	50	1060000000
WAP WDU2.5N/4N BL	1.5 mm	50	1060080000
Width			
WEW 35/2	8 mm	100	1061200000
Width			
WTA 1 WDU1.5	5 mm	25	1632290000
WTA 1/ZA WDU1.5	5 mm	25	1632300000
Width			
WAD 4 GE BED	4.5 mm	50	1072000000
WAD 4 WS	4.5 mm	50	1072100000
Width			
DEK 5/5 / WS 12/5			
Socket and test plug, see section "W-Series accessories".			

WDU 4

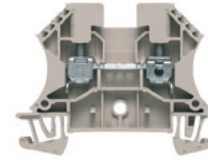
4 mm²

6.1 x 60 x 47
41 / 6
0.13...6

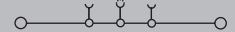

IEC 60947-7-1

Ex e II II 2 G D

IEC	UL	CSA	EN 60079-7
800	600 (C)	600 (C)	690
32	35 (C)	35 (C)	28
4	AWG 22...10	AWG 26...10	4
8 kV / 3			
A4 / V-0			



KEMA 98ATEX1683 U

Rated connection	Further connection
0.5...6 / 1.5...6	
0.5...6 / 0.5...4	
0.5...1 Nm (M 3)	
10 / 0.6 x 3.5 mm	
0.5...2.5	
0.5...1.5 / 0.5...1.5	
Rated voltage is 400 V when using the ZQV cross-connector. Note max. current of terminal (41 A) when using WQV!	

Type	Qty.	Order No.
WDU 4	100	1020100000
WDU 4 BL	100	1020180000

1000 V DC rated voltage tested.
Refer to the W-Series Accessories section for colour versions.

Type	current	Qty.	Order No.
ZQV 4N/2 GE	32 A	60	1758250000
ZQV 4N/3 GE	32 A	60	1762630000
ZQV 4N/4 GE	32 A	60	1762620000
ZQV 4N/10 GE	32 A	20	1758260000
ZQV 4N/20 GE	32 A	20	1909020000
Width			
WQV 4/2	32 A	50	1051960000
WQV 4/3	32 A	50	1054560000
WQV 4/4	32 A	50	1054660000
WQV 4/10	41 A	20	1052060000
Width			
WAP 2.5-10	1.5 mm	50	1050000000
WAP 2.5-10 BL	1.5 mm	50	1050080000
WAP 16+35 WTW 2.5-10	1.5 mm	20	1050100000
WAP 16+35 WTW 2.5-10 BL	1.5 mm	20	1050180000
Width			
WEW 35/2	8 mm	100	1061200000
Width			
WTA 3 WDU4	6 mm	25	1632350000
WTA 3/ZA WDU4	6 mm	25	1632360000
Width			
WAD 5 MC NE WS	5 mm	48	1112910000
WAD 5 MC NE GE	5 mm	48	1112920000
Width			
WS 12/6			
Socket and test plug refer to W-series Accessories section Only 400 V when using the shielding rail LS 2.8 1056400000.			

WDU 4/ZZ

4 mm²

Twin connection

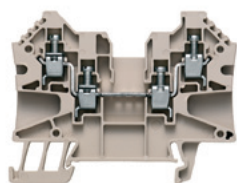

6.1 x 70 x 53.5
32 / 6
0.05...6

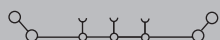

IEC 60947-7-1

Ex e II II 2 G D

IEC	UL	CSA	EN 60079-7
800	600 (C)	600 (C)	
32	30 (C)	30 (C)	
4	AWG 30...10	AWG 30...10	4
8 kV / 3			
A4 / V-0			



Rated connection	Further connection
0.5...6 / 0.5...6	0.5...6
0.5...4 / 0.5...4	0.5...4 / 0.5...4
0.5...0.8 Nm (M 3)	
10 / 0.6 x 3.5 mm	
0.5...1.5	
0.5...1.5 / 0.5...1.5	

Type	Qty.	Order No.
WDU 4/ZZ	50	1905060000

Type	current	Qty.	Order No.
ZQV 4N/2 GE	32 A	60	1758250000
ZQV 4N/3 GE	32 A	60	1762630000
ZQV 4N/4 GE	32 A	60	1762620000
ZQV 4N/10 GE	32 A	20	1758260000
ZQV 4N/20 GE	32 A	20	1909020000

Width			
WAP WDU/WTR4/ZR	1.5 mm	50	1905070000

WEW 35/2	8 mm	100	1061200000
----------	------	-----	------------

DEK 5/6 / WS 12/6

WDU 4/ZR

4 mm²

Supplementary connection, right

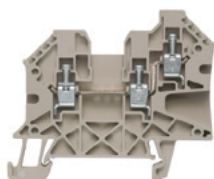

6.1 x 63.5 x 53.5
32 / 6
0.05...6



IEC 60947-7-1

Ex e II II 2 G D

IEC	UL	CSA	EN 60079-7
800	600 (C)	600 (C)	
32	30 (C)	30 (C)	
4	AWG 30...10	AWG 30...10	4
8 kV / 3			
A4 / V-0			



Rated connection	Further connection
0.5...6 / 0.5...6	0.5...6
0.5...4 / 0.5...4	0.5...4 / 0.5...4
0.5...0.8 Nm (M 3)	
10 / 0.6 x 3.5 mm	
0.5...1.5	
0.5...1.5 / 0.5...1.5	

Type	Qty.	Order No.
WDU 4/ZR	50	1905140000

Type	current	Qty.	Order No.
ZQV 4N/2 GE	32 A	60	1758250000
ZQV 4N/3 GE	32 A	60	1762630000
ZQV 4N/4 GE	32 A	60	1762620000
ZQV 4N/10 GE	32 A	20	1758260000
ZQV 4N/20 GE	32 A	20	1909020000

Width			
WAP WDU/WTR4/ZR	1.5 mm	50	1905070000

WEW 35/2	8 mm	100	1061200000
----------	------	-----	------------

DEK 5/6 / WS 12/6

WDU 4N

4 mm²

Compact design

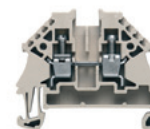

6.1 x 44 x 38.5
39 / 6
0.13...6



IEC 60947-7-1

Ex e II II 2 G D

IEC	UL	CSA	EN 60079-7
500	300 (D)		440
32	10 (D)		27
4	AWG 26...10		4
6 kV / 3			
A4 / V-0			



KEMA 98ATEX1683 U

Rated connection	Further connection
0.5...6 / 1.5...6	
0.5...4 / 0.5...4	
0.5...1 Nm (M 3)	
11 / 0.6 x 3.5 mm	
0.5...1.5	

Type	Qty.	Order No.
WDU 4N	100	1042600000
WDU 4N BL	100	1042680000

Type	current	Qty.	Order No.
ZQV 4N/2 GE	32 A	60	1758250000
ZQV 4N/3 GE	32 A	60	1762630000
ZQV 4N/4 GE	32 A	60	1762620000
ZQV 4N/10 GE	32 A	20	1758260000
ZQV 4N/20 GE	32 A	20	1909020000

Width			
WAP WDU2.5N/4N	1.5 mm	50	1060000000
WAP WDU2.5N/4N BL	1.5 mm	50	1060080000

WTA 1 WDU1.5	5 mm	25	1632290000
WTA 1/ZA WDU1.5	5 mm	25	1632300000

WAD 4 GE BED	4.5 mm	50	1072000000
WAD 4 WS	4.5 mm	50	1072100000

DEK 5/6 / WS 12/6

Feed-through terminals

Identically contoured design of 2.5 to 10 mm² with identical end plates and partitions. An unmatched combination of many advantages!

The compact terminals are impressive for their small size and rated cross-section capacity.

In hazardous area applications, the installation instructions and the rated data specifications for accessories given in the technical appendix must be followed.

Width/Length/Height of lowest version	mm
max. current / max. cond. cross-section	A/mm ²
Max. clamping range	mm ²



Technical data

Rated data	
Rated voltage	V
Rated current	A
Rated cross-section	mm ²
Rated impulse withstand voltage / Pollution severity Gauge to IEC 60947-1 / Flammability class UL94	
Approvals	
Clamped conductors (H05V/H07V)	
Solid / stranded	mm ²
Flexible / Flexible with ferrule	mm ²
Tightening torque range (terminal screw)	
Stripping length / Blade size	mm/-
2 conductors with same cross-section (H05V/H07V)	
Solid / stranded	mm ²
Flexible / Flexible with ferrule	mm ²
Note	

Ordering data

Version	
	Dark beige Wemid
	Blue Wemid
Note	

Accessories

Screwable cross-connection	
	2-pole
	3-pole
	4-pole
	10-pole
End plate / Partition plate	
	Dark beige Wemid
	Blue Wemid
	Dark beige Wemid
	Blue Wemid
End bracket	
	Dark beige Wemid
Testing / Checking	
	Standard
Cover	
	With lightning flash symbol
	Blank, white
	Blank, yellow

Identification systems	
	(see assortment in catalogue 7)
	Marking tags
Note	

WDU 6

6 mm²

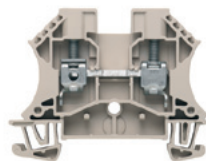

7.9 x 60 x 4.7
57 / 10
0.22...10



IEC 60947-7-1 Ex e II  II 2 G D

IEC	UL	CSA	EN 60079-7
800	600 (C)	600 (C)	550
41	50 (C)	50 (C)	36
6	AWG 22...8	AWG 22...8	6
8 kV / 3			
A5 / V-0			

 KEMA 98ATEX1683 U

Rated connection	Further connection
0.5...10 / 1.5...10	
0.5...10 / 0.5...6	
0.8...1.6 Nm (M 3.5)	
12 / 4.0 x 0.8 mm	
2 conductors with same cross-section (H05V/H07V)	
Solid / stranded	0.5...2.5
Flexible / Flexible with ferrule	0.5...2.5 / 0.5...2.5
Note	
Note max. current of terminal (57 A) when using WQV! Conductor connection H07V...10 and AWG 8 tighten with 1.4-1.6 Nm.	

Type	Qty.	Order No.
WDU 6	100	1020200000
WDU 6 BL	100	1020280000
1000 V DC rated voltage tested. Refer to the W-Series Accessories section for colour versions.		

Type	current	Qty.	Order No.
WQV 6/2	57 A	50	1052360000
WQV 6/3	57 A	50	1054760000
WQV 6/4	57 A	50	1054860000
WQV 6/10	57 A	20	1052260000
Width			
WAP 2.5-10	1.5 mm	50	1050000000
WAP 2.5-10 BL	1.5 mm	50	1050080000
WAP 16+35 WTW 2.5-10	1.5 mm	20	1050100000
WAP 16+35 WTW 2.5-10 BL	1.5 mm	20	1050180000
Width			
WEW 35/2	8 mm	100	1061200000
WTA 5/1	5 mm	25	1051260000
Width			
WAD 8 MC NE WS	8 mm	48	1112940000
WAD 8 MC NE GE	8 mm	48	1112950000

Identification systems	
	(see assortment in catalogue 7)
	Marking tags
Note	
DEK 5/8 / WS 12/6,5	
Socket and test plug refer to W-series Accessories section Only 400 V when using the shielding rail LS 2.8 1056400000.	

WDU 10

10 mm²

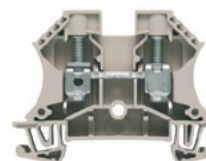

9.9 x 60 x 4.7
76 / 16
1.31...16

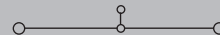

IEC 60947-7-1 Ex e II  II 2 G D

IEC	UL	CSA	EN 60079-7
1000	600 (C)	600 (C)	550
57	65 (C)	65 (C)	50
10	AWG 18...6	AWG 18...6	10
8 kV / 3			
B6 / V-0			

 KEMA 98ATEX1683 U

Rated connection	Further connection
1.5...16 16	
1.5...16 / 1.5...16	
1.2...2.4 Nm (M 4)	
12 / 1.0 x 5.5 mm	
2 conductors with same cross-section (H05V/H07V)	
Solid / stranded	1.5...6 / 0.5...6
Flexible / Flexible with ferrule	0.5...6 / 0.5...6
Note	
Note max. current of terminal (76 A) when using WQV. AWG 6/7 and H07V-R16 tighten with 2.4 Nm.	

Type	Qty.	Order No.
WDU 10	50	1020300000
WDU 10 BL	50	1020380000
For colour variants, refer to the W-Series accessories section, "Specific functions".		

Type	current	Qty.	Order No.
WQV 10/2	57 A	50	1052560000
WQV 10/3	57 A	50	1054960000
WQV 10/4	57 A	50	1055060000
WQV 10/10	57 A	20	1052460000
Width			
WAP 2.5-10	1.5 mm	50	1050000000
WAP 2.5-10 BL	1.5 mm	50	1050080000
WAP 16+35 WTW 2.5-10	1.5 mm	20	1050100000
WAP 16+35 WTW 2.5-10 BL	1.5 mm	20	1050180000
Width			
WEW 35/2	8 mm	100	1061200000
WTA 5/1	5 mm	25	1051260000
Width			
WAD 8 MC NE WS	8 mm	48	1112940000
WAD 8 MC NE GE	8 mm	48	1112950000

Identification systems	
	(see assortment in catalogue 7)
	Marking tags
Note	
DEK 5/5 / WS 12/6,5	
Socket and test plug refer to W-series Accessories section Only 400 V when using the shielding rail LS 2.8 1056400000.	

WDU 10/ZR

10 mm²

Supplementary connection, right (4 mm²)

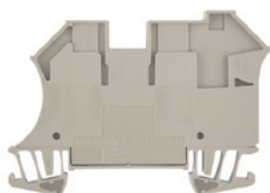

9.9 x 70 x 49.5
76 / 16
1.31...16

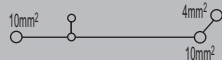

IEC 60947-7-1

IEC	UL	CSA
800	600 (C)	600 (C)
57	65 (C)	65 (C)
10	AWG 16...6	AWG 16...6
8 kV / 3 B6, A4 / V-0		



Rated connection	Further connection
1.5...16 / 1.5...16	0.5...6 / 1.5...4
1...6 / 1.5...16	0.5...4 / 0.5...4
1.2...2.4 Nm (M 4)	
12 / 0.6 x 3.5 mm	10 / 0.6 x 3.5 mm

1.5...6
 1...6 / 1..6

Note max. current of terminal (76 A) when using WQV, AWG 6/7 and H07V-R16 secured with 2.4 Nm. ZR connection top right A 4.

Type	Qty.	Order No.
WDU 10/ZR	50	1042400000
WDU 10/ZR BL	50	1042480000

The rated specifications refer to the 10 mm² connection.

Type	current	Qty.	Order No.
WQV 10/2	57 A	50	1052560000
WQV 10/3	57 A	50	1054960000
WQV 10/4	57 A	50	1055060000
WQV 10/10	57 A	20	1052460000
Width			
WAP 16+35 WTW 2.5-10	1.5 mm	20	1050100000
WAP 16+35 WTW 2.5-10 BL	1.5 mm	20	1050180000
WEW 35/2	8 mm	100	1061200000
WTA 5/1	5 mm	25	1051260000

DEK 5/5 / WS 12/6,5

Socket and test plug, see section "W-Series accessories".

WDU 16

16 mm²

With peg for higher connection stability

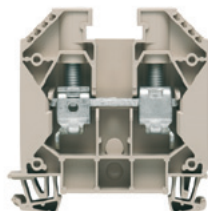

11.9 x 60 x 63
101 / 25
0.82...25

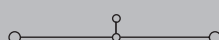

IEC 60947-7-1



IEC	UL	CSA	EN 60079-7
1000	600 (C)	600 (C)	690
76	85 (C)	85 (C)	66
16	AWG 18...4	AWG 18...6	16
8 kV / 3 B7 / V-0			



KEMA 98ATEX1683 U

Rated connection	Further connection
1.5...16 / 1.5...25	
1.5...25 / 1.5...16	
3...4 Nm (M 5)	
16 / 1.0 x 5.5 mm	

1.5...4
 1.5...4 / 1.5...4

Conductor connection H07V...16 and AWG 6 with tightening torque of 2.0-2.4 Nm.

Type	Qty.	Order No.
WDU 16/ZA	50	1028900000
WDU 16/ZA BL	50	1028980000

Order no. 1020400000 and 1020480000 (blue) versions without pegs (50 pcs.)

Type	current	Qty.	Order No.
WQV 16/2	76 A	50	1053260000
WQV 16/3	76 A	50	1055160000
WQV 16/4	76 A	50	1055260000
WQV 16/10	76 A	10	1053360000
Width			
WAP 16+35 WTW 2.5-10	1.5 mm	20	1050100000
WAP 16+35 WTW 2.5-10 BL	1.5 mm	20	1050180000
WEW 35/1	12 mm	50	1059000000
WAD 12 M. BL.	12 mm	50	1055960000
WAD 12 NEUTRAL	12 mm	50	1056260000

DEK 5/5 / WS 12/6,5

Socket and test plug, see section "W-Series accessories".

WDU 16N

16 mm²

Suitable for power distribution
 Compact design



12 x 60 x 47
101 / 25
1.5...25

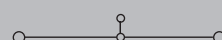

IEC 60947-7-1

IEC	UL	CSA
690	300 (C)	300 (C)
76	70 (C)	70 (C)
16	AWG 14...6	AWG 14...6
8 kV / 3 B7 / V-0		



Rated connection	Further connection
1.5...16 / 1.5...25	
1.5...16 / 1.5...16	
1.2...2.4 Nm (M 4)	
12 / 1.0 x 5.5 mm	

1.5...4
 1.5...4 / 1.5...4

AWG 6/7 and H07V-R25 tighten with a tightening torque of 1.5 Nm.

Type	Qty.	Order No.
WDU 16N	50	1036100000
WDU 16N BL	50	1036180000

Type	current	Qty.	Order No.
WQV 16N/2	76 A	50	1636560000
WQV 16N/3	76 A	50	1636570000
WQV 16N/4	76 A	50	1636580000
Width			
WTW EN	3 mm	20	1058800000
WEW 35/2	8 mm	100	1061200000
WTA 2 WDU2.5-10	5 mm	25	1632320000
WAD 12N GE BED	12 mm	50	1073200000
WAD 12 NEUTRAL	12 mm	50	1056260000

DEK 5/5 / WS 10/12

Socket and test plug, see section "W-Series accessories".

Feed-through terminals

Identically contoured design of 2.5 to 10 mm² with identical end plates and partitions. An unmatched combination of many advantages!
The compact terminals are impressive for their small size and rated cross-section capacity.

In hazardous area applications, the installation instructions and the rated data specifications for accessories given in the technical appendix must be followed.

Width/Length/Height of lowest version	mm
max. current / max. cond. cross-section	A/mm ²
Max. clamping range	mm ²



Technical data

Rated data	
Rated voltage	V
Rated current	A
Rated cross-section	mm ²
Rated impulse withstand voltage / Pollution severity	
Gauge to IEC 60947-1 / Flammability class UL94	
Approvals	
Clamped conductors (H05V/H07V)	
Solid / stranded	mm ²
Flexible / Flexible with ferrule	mm ²
Tightening torque range (terminal screw)	
Stripping length / Blade size	mm/-
2 conductors with same cross-section (H05V/H07V)	
Solid / stranded	mm ²
Flexible / Flexible with ferrule	mm ²
Note	

Ordering data

Version	
	Dark beige Wemid
	Blue Wemid
Note	

Accessories

Screwable cross-connection	
	2-pole
	3-pole
	4-pole
	10-pole
End plate / Partition plate	
	Dark beige Wemid
	Blue Wemid
	Dark beige Wemid
	Blue Wemid
End bracket	Dark beige Wemid
Testing / Checking	Standard
Cover	
	With lightning flash symbol
	Blank, white
	Blank, yellow

Identification systems	(see assortment in catalogue 7)
	Marking tags
Note	

WDU 35

35 mm²

Clamping screw / spigot for good connection stability

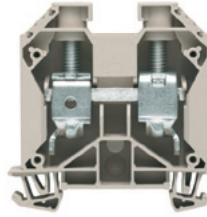

16 x 60 x 63
150 / 50
2.5...50

IEC 60947-7-1 Ex e II  II 2 G D

IEC	UL	CSA	EN 60079-7
1000	1000 (C)	1000 (C)	690
125	150 (C)	150 (C)	109
35	AWG 12...0	AWG 12...2	35
8 kV / 3			
B8 / V-0			

 KEMA 98ATEX1683 U

Rated connection	Further connection
2.5...16 / 2.5...50	
2.5...35 / 2.5...35	
4...5 Nm (M 6)	
18 / 6.5 x 1.2 mm	
2.5...10 / 16...16	
2.5...16 / 2.5...16	

Type	Qty.	Order No.
WDU 35/ZA	40	1028800000
WDU 35/ZA BL	40	1028880000
Order no. 1020500000 and 1020580000 (blue) versions without pegs (40 pcs.)		

Type	current	Qty.	Order No.
WQV 35/2	135 A	50	1053060000
WQV 35/3	112 A	50	1055360000
WQV 35/4	112 A	50	1055460000
WQV 35/10	112 A	10	1053160000
Width			
WAP 16+35 WTW 2.5-10	1.5 mm	20	1050100000
WAP 16+35 WTW 2.5-10 BL	1.5 mm	20	1050180000
WEW 35/1	12 mm	50	1059000000
WAD 12 M. BL.	12 mm	50	1055960000
WAD 12 NEUTRAL	12 mm	50	1056260000

DEK 5/5 / WS 12/6,5
Socket and test plug, see section "W-Series accessories".

WDU 35 IK

35 mm²

Hexagonal socket / spigot for good connection stability

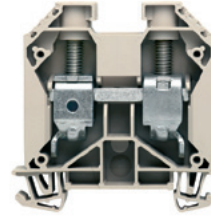

16 x 60 x 63
150 / 50
2.5...50

IEC 60947-7-1 Ex e II  II 2 G D

IEC	UL	CSA	EN 60079-7
1000	600 (C)	600 (C)	690
125	150 (C)	120 (C)	109
35	AWG 12...12	AWG 12...2	35
8 kV / 3			
B8 / V-0			

 KEMA 98ATEX1683 U

Rated connection	Further connection
2.5...16 / 2.5...50	
2.5...35 / 2.5...35	
4...6 Nm (M 6)	
18 / S6 (DIN 6911)	
2.5...10 / 16...16	
2.5...16 / 2.5...16	

Type	Qty.	Order No.
WDU 35/IK/ZA	25	1029000000
Order no. 1020600000 and 1020680000 (blue) versions without pegs (25 pcs.)		

Type	current	Qty.	Order No.
WQV 35/2	135 A	50	1053060000
WQV 35/3	112 A	50	1055360000
WQV 35/4	112 A	50	1055460000
WQV 35/10	112 A	10	1053160000
Width			
WAP 16+35 WTW 2.5-10	1.5 mm	20	1050100000
WAP 16+35 WTW 2.5-10 BL	1.5 mm	20	1050180000
WEW 35/1	12 mm	50	1059000000
WAD 12 M. BL.	12 mm	50	1055960000
WAD 12 NEUTRAL	12 mm	50	1056260000

DEK 5/5 / WS 12/6,5
Socket and test plug, see section "W-Series accessories".

WDU 35N

35 mm²

Suitable for power distribution
Compact design



16 x 66 x 51
150 / 50
2.5...50

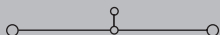

IEC 60947-7-1

IEC	UL	CSA
500	1000 (C)	300 (D)
125	150 (C)	10 (D)
35	AWG 12...0	AWG 12...2
6 kV / 3		
B8 / V-0		

®

Rated connection	Further connection
2.5...16 / 2.5...50	
2.5...35 / 2.5...35	
4...5 Nm (M 6)	
18 / 6.5 x 1.2 mm	
2.5...6	
2.5...6 / 2.5...6	

Type	Qty.	Order No.
WDU 35N	20	1040400000
WDU 35N BL	20	1040480000

1000 V UL and CSA for usage groups B and C: can be used with isolating DIN rails and when using WTW-type partitions.

Type	current	Qty.	Order No.
WQV 35N/2	135 A	20	1079200000
WQV 35N/3	101 A	20	1079300000
WQV 35N/4	101 A	20	1079400000
Width			
WTW EN	3 mm	20	1058800000
WEW 35/2	8 mm	100	1061200000
WAD 16N GE BED	15.8 mm	50	1083600000

DEK 5/5 / WS 12/6,5

Feed-through terminals

Identically contoured design of 2.5 to 10 mm² with identical end plates and partitions. An unmatched combination of many advantages!
The compact terminals are impressive for their small size and rated cross-section capacity.

In hazardous area applications, the installation instructions and the rated data specifications for accessories given in the technical appendix must be followed.

Width/Length/Height of lowest version	mm
max. current / max. cond. cross-section	A/mm ²
Max. clamping range	mm ²



Technical data

Rated data	
Rated voltage	V
Rated current	A
Rated cross-section	mm ²
Rated impulse withstand voltage / Pollution severity Gauge to IEC 60947-1 / Flammability class UL94	
Approvals	
Clamped conductors (H05V/H07V)	
Solid / stranded	mm ²
Flexible / Flexible with ferrule	mm ²
Tightening torque range (terminal screw)	
Stripping length / Blade size	mm/-
2 conductors with same cross-section (H05V/H07V)	
Solid / stranded	mm ²
Flexible / Flexible with ferrule	mm ²
Note	

Ordering data

Version	
	Dark beige Wemid
	Blue Wemid
Note	

Accessories

Screwable cross-connection	
	2-pole
	3-pole
	4-pole
End bracket	
	Dark beige Wemid
Cover	
	With lightning flash symbol
Additional connection	
	10 mm ²

Identification systems	(see assortment in catalogue 7)
	Marking tags
Note	

WDU 50N

50 mm²

Compact design

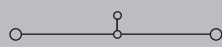

18.5 x 70 x 70.6	
192 / 70	
10...70	

IEC 60947-7-1 Ex e II  II 2 G D

IEC	UL	CSA	EN 60079-7
1000	600 (C)	600 (C)	690
150	150 (C)	150 (C)	126
50	AWG 10...0	AWG 8...0	50
8 kV / 3			
B10 / V-0			

Rated connection		Further connection	
10...16 / 10...70			
10...50 / 10...50			
3.5...6 Nm (M 6)			
24 / S4 (DIN 6911)			
KEMA 98ATEX1685 U			
...16 / 6...16			
6...16 / 6...16			
Copper straps can be used; see online catalogue for possible connections.			

Type	Qty.	Order No.
WDU 50N	10	1820840000
WDU 50N BL	10	1820850000
1000 V UL and CSA for usage groups B and C: can be used with isolating DIN rails and when using WTW-type partitions.		

Type	current	Qty.	Order No.
WQV 50N/2	150 A	5	1834060000
WQV 50N/3	150 A	5	1834070000
WQV 50N/4	150 A	5	1834080000
Width			
WEW 35/1	12 mm	50	1059000000
WAD 20 GE WSD	18 mm	10	9512260000
WZAD 50N	12.5 mm	5	1872720000

Identification systems	(see assortment in catalogue 7)
	Marking tags
DEK 5/5 / WS 12/6,5	
Auxiliary connection for additional conductor "WZAD 50N" 1872720000 (up to 10 mm ² , 41 A).	

WDU 50N IR

50 mm²

Six-lobe socket

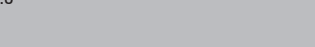

NEW

18.5 x 70 x 70.6	
192 / 70	
10...70	

IEC 60947-7-1

IEC	UL	CSA
1000		
150		
50		
8 kV / 3		
B10 / V-0		

Rated connection		Further connection	
10...16 / 10...70			
10...50 / 10...50			
3...6 Nm (M 6)			
24 /			
...16 / 6...16			
6...16 / 6...16			

Type	Qty.	Order No.
WDU 50N IR	10	1186630000
1000 V UL and CSA for usage groups B and C: can be used with isolating DIN rails and when using WTW-type partitions.		

Type	current	Qty.	Order No.
WQV 50N/2	150 A	5	1834060000
WQV 50N/3	150 A	5	1834070000
WQV 50N/4	150 A	5	1834080000
Width			
WEW 35/1	12 mm	50	1059000000
WAD 20 GE WSD	18 mm	10	9512260000
WZAD 50N	12.5 mm	5	1872720000

Identification systems	(see assortment in catalogue 7)
	Marking tags
DEK 5/5 / WS 12/6,5	

WDU 70N

70 mm²

Compact design

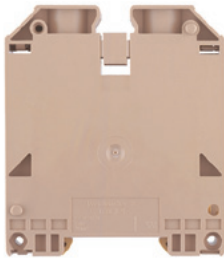

20.5 x 75 x 86
232 / 95
10...95

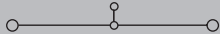

IEC 60947-7-1

Ex e II II 2 G D

IEC	UL	CSA	EN 60079-7
1000	600 (C)	600 (C)	690
192	195 (C)	205 (C)	167
70	AWG 6...000	AWG 6...000	70
8 kV / 3			
B11 / V-0			

KEMA 98ATEX1683 U

Rated connection	Further connection
10...16 / 10...95	
10...70 / 10...70	
6...12 Nm (M 8)	
22 / S6 (DIN 6911)	
10...16 / 10...	
10...25 / 6...25	

Copper straps can be used; see online catalogue for possible connections.

Type	Qty.	Order No.
WDU 70N/35	10	9512190000
WDU 70N/35 BL	10	9512420000

1000 V UL and CSA for usage groups B and C: can be used with isolating DIN rails and when using WTW-type partitions.

Type	current	Qty.	Order No.
WQV 70N/2	192 A	5	9512240000
WQV 70N/3	192 A	5	9512250000
WQV 70N/4	192 A	5	9531290000
Width			
WEW 35/1	12 mm	50	1059000000
WAD 20 GE WSD	18 mm	10	9512260000
WZAD 70N	12.5 mm	5	1964830000

DEK 5/5 / WS 12/6,5

Auxiliary connection for additional conductor "WZAD 70N" 1964830000 (up to 10 mm², 41 A).

WDU 95N/120N

120 mm²

Compact design



27 x 91 x 91
290 / 150
16...150

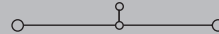

IEC 60947-7-1

Ex e II II 2 G D

IEC	UL	CSA	EN 60079-7
1000	1000 (C)	1000 (C)	880
269	228 (C)	220 (C)	243
120	AWG 4...250	AWG 4...0000	120
8 kV / 3			
B13 / V-0			

KEMA 98ATEX1683 U

Rated connection	Further connection
16...16 / 16...150	
16...120 / 16...95	
12...20 Nm M 10	
27 / S6 (DIN 6911)	
16...16 / 10...35	
16...35 / 10...35	

Copper straps can be used. See online cat. When connecting AWG conductor of 250 kcmil, use stripping length 30 mm and tightening torque 16 Nm.

Type	Qty.	Order No.
WDU 95N/120N	5	1820550000
WDU 95N/120N BL	5	1820560000

1000 V UL and CSA for usage groups B and C: can be used with isolating DIN rails and when using WTW-type partitions.

Type	current	Qty.	Order No.
WQV 95/120/2	269 A	5	1826890000
WQV 95/120/3	269 A	5	1826900000
WQV 95/120/4	269 A	5	1826910000
Width			
WEW 35/1	12 mm	50	1059000000
WAD 20 GE WSD	18 mm	10	9512260000
WZAD 95N/120N	12.5 mm	5	1859580000

DEK 5/5 / WS 12/6,5

Auxiliary connection for additional conductor "WZAD 95N/120N" 1859580000 (up to 10 mm², 41 A).

WDU 240

240 mm²



36 x 100 x 124
415 / 240
70...240

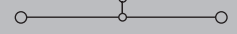

IEC 60947-7-1

Ex e II II 2 G D

IEC	UL	CSA	EN 60079-7
1000	600 (C)	600 (C)	1100
415	380 (C)	400 (C)	300
240	AWG 0...500		240
8 kV / 3			
B15 / V-0			

KEMA 01ATEX2186 U

Rated connection	Further connection
70...240 / 70...240	
70...240 / 70...185	
25...30 Nm M 10	
40 / S8 (DIN 6911)	
/ 35...95	
50...95 / 35...50	

Copper straps can be used; see online catalogue for possible connections.

Type	Qty.	Order No.
WDU 240	2	1802780000
WDU 240 BL	2	1822210000

Type	current	Qty.	Order No.
WQB 240/2	320 A	5	1802790000
WQB 240/3	320 A	5	1802800000
Width			
WEW 35/1	12 mm	50	1059000000
WZAD 240	10.15 mm	5	1802810000

DEK 5/5 / WS 12/6,5

Aux. connection for extra conductor "WZAD 240", Order no. 1802810000 (up to 10 mm², 57 A) ELPF insertion profile, for ribbon cable, Order no. 1824680000.

Feed-through terminals

Wires with large cross-sections do not need forceful pushing in. Instead they can be simply inserted into the terminal block.

Direct mounting is possible using the elongated slots in the bottom of the terminal.

In hazardous area applications, the installation instructions and the rated data specifications for accessories given in the technical appendix must be followed.

Width/Length/Height of lowest version	mm
max. current / max. cond. cross-section	A/mm ²
Max. clamping range	mm ²



Technical data

Rated data	
Rated voltage	V
Rated current	A
Rated cross-section	mm ²
Rated impulse withstand voltage / Pollution severity Gauge to IEC 60947-1 / Flammability class UL94	
Approvals	
Clamped conductors (H05V/H07V)	
Solid / stranded	mm ²
Flexible / Flexible with ferrule	mm ²
Tightening torque range (terminal screw)	
Stripping length / Blade size	mm/-
2 conductors with same cross-section (H05V/H07V)	
Solid / stranded	mm ²
Flexible / Flexible with ferrule	mm ²
Note	

Ordering data

Version	
	Dark beige Wemid
	Blue Wemid
Note	

Accessories

Screwable cross-connection	
	2-pole
	3-pole
End bracket	
	Dark beige Wemid
Cover	
	With lightning flash symbol
	Blank, white
Additional connection	
	4 mm ²

Identification systems	
	(see assortment in catalogue 7)
	Marking tags
Note	

WDU 70/95

95 mm²

Conductor can be inserted from above / leaf spring

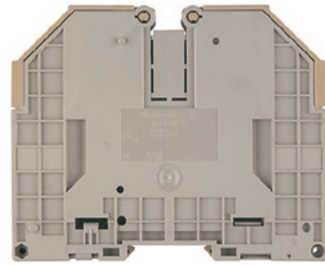

27 x 132 x 115.5	
232 / 120	
13.3...120	

IEC 60947-7-1 Ex e II  II 2 G D

IEC	UL	CSA	EN 60079-7
1000	1000 (C)	600 (C)	690
232	175 (C)	205 (C)	202
95	AWG 6...00	AWG 6...00	95
8 kV / 3			
B12 / V-0			

 KEMA 98ATEX1686 U

Rated connection	Further connection
16...16 / 16...120	
16...95 / 16...95	
6...12 Nm (M 8)	
30 / S6 (DIN 6911)	
16...16 / 16...35	
16...35 / 16...35	

Type	Qty.	Order No.
WDU 70/95	10	1024600000
WDU 70/95 BL	10	1024680000
Refer to the online catalogue for information on the ribbon cable. Refer to the W-Series accessories section for information on direct mounting.		

Type	current	Qty.	Order No.
WQV 70/95/2	192 A	5	1063500000
WQV 70/95/3	232 A	5	1063600000
Width			
WEW 35/1	12 mm	50	1059000000
WAD 27 M. BL.	27 mm	10	1062860000
WAD 27 NEUTRAL	27 mm	10	1062960000
WZAD 70/95	19.7 mm	10	1066000000

DEK 5/5 / WS 12/6,5
Auxiliary connection for the additional conductor "WZAD 70", Order no. 1066000000 (up to 4 mm ² , 32 A).

WDU 120/150

150 mm²

Conductor can be inserted from above / leaf spring

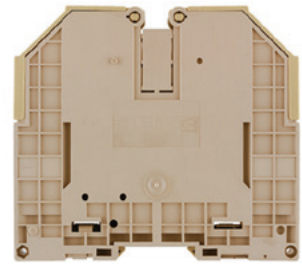

32 x 132 x 125.5	
309 / 150	
33.63...150	

IEC 60947-7-1 Ex e II  II 2 G D

IEC	UL	CSA	EN 60079-7
1000	1000 (C)	600 (C)	1100
309	225 (C)	285 (C)	234
150	AWG 2...250	AWG 2...250	150
8 kV / 3			
B13 / V-0			

 KEMA 98ATEX1686 U

Rated connection	Further connection
/ 35...150	
35...150 / 35...150	
10...20 Nm M 10	
35 / S6 (DIN 6911)	
...16 / 35...70	
35...70 / 35...70	

Type	Qty.	Order No.
WDU 120/150	10	1024500000
WDU 120/150 BL	10	1024580000
Refer to the online catalogue for information on the ribbon cable. Refer to the W-Series accessories section for information on direct mounting.		

Type	current	Qty.	Order No.
WQV 120/2	269 A	5	1063300000
WQV 120/3	269 A	5	1063400000
Width			
WEW 35/1	12 mm	50	1059000000
WAD 27 M. BL.	27 mm	10	1062860000
WAD 27 NEUTRAL	27 mm	10	1062960000
WZA D120	24 mm	10	1066100000

DEK 5/5 / WS 12/6,5
Auxiliary connection for the additional conductor "WZAD 120", Order no. 1066100000 (up to 4 mm ² , 32 A).

Double-level terminals

Identically contoured design of 2.5 to 10 mm² with identical end plates and partitions. An unmatched combination of many advantages!
The compact terminals are impressive for their small size and rated cross-section capacity.

In hazardous area applications, the installation instructions and the rated data specifications for accessories given in the technical appendix must be followed.

Width/Length/Height of lowest version	mm
max. current / max. cond. cross-section	A/mm ²
Max. clamping range	mm ²



Technical data

Rated data	
Rated voltage	V
Rated current	A
Rated cross-section	mm ²
Rated impulse withstand voltage / Pollution severity Gauge to IEC 60947-1 / Flammability class UL94	
Approvals	
Clamped conductors (H05V/H07V)	
Solid / stranded	mm ²
Flexible / Flexible with ferrule	mm ²
Tightening torque range (terminal screw)	
Stripping length / Blade size	mm/-
2 conductors with same cross-section (H05V/H07V)	
Solid / stranded	mm ²
Flexible / Flexible with ferrule	mm ²
Note	

Ordering data

Version	Dark beige Wemid
	Blue Wemid
Note	

Accessories

Pluggable cross-connection	
	2-pole
	3-pole
	4-pole
	10-pole
	20-/24-pole
Screwable cross-connection	
	2-pole
	3-pole
	4-pole
	10-pole
End plate / Partition plate	
	Dark beige Wemid
	Blue Wemid
	Dark beige Wemid
End bracket	
	Dark beige Wemid
Screwdriver	
	Standard
Cover	
	With lightning flash symbol
	Blank, white
Identification systems	
	(see assortment in catalogue 7)
	Marking tags
Note	

WDK 2.5 ZQV

2.5 mm²

Plug-in cross-connection

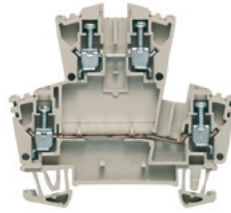

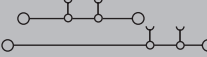
5.1 x 65.4 x 63.5	
32 / 4	
0.05...4	

IEC 60947-7-1 Ex e II  II 2 G D

IEC	UL	CSA	EN 60079-7
400	300 (C)	300 (C)	275
24	20 (C)	25 (C)	21
2.5	AWG 30...12	AWG 26...12	2.5
6 kV / 3			
A3 / V-0			

	KEMA 98ATEX1687 U
Rated connection	
Solid / stranded	0.5...4 / 1.5...4
Flexible / Flexible with ferrule	0.5...4 / 0.5...2.5
Tightening torque range (M 2.5)	
10 / 0.6 x 3.5 mm	
2 conductors with same cross-section	
Solid / stranded	0.5...1.5
Flexible / Flexible with ferrule	0.5...1.5 / 0.5...1.5
2.5 mm ² wires with wire ferrules including the plastic collar only clampable with diameter-optimised collar (Order no. 1333100000, pack of 500)	

Type	Qty.	Order No.
WDK 2.5 ZQV	100	1041100000
WDK 2.5 ZQV BL	100	1041180000
Rated voltage is 400 V when using cross-connection ZQV Refer to the W-Series Accessories section for colour versions.		

Type	current	Qty.	Order No.
ZQV 2.5N/2 GE	24 A	60	1693800000
ZQV 2.5N/3 GE	24 A	60	1693810000
ZQV 2.5N/4 GE	24 A	60	1693820000
ZQV 2.5N/10 GE	24 A	20	1693880000
ZQV 2.5N/20 GE	24 A	20	1909000000
Width			
WAP WDK2.5	1.5 mm	20	1059100000
WAP WDK2.5 BL	1.5 mm	20	1059180000
WTW EN	3 mm	20	1058800000
Width			
WEW 35/1	12 mm	50	1059000000
Width			
WAD 4 GE BED	4.5 mm	50	1072000000
WAD 4 WS	4.5 mm	50	1072100000

DEK 5/5 / WS 8/5	Test plug and socket, see section "W-Series accessories" Ensure 2.5 mm ² max. when using the WQB.
------------------	---

WDK 2.5

2.5 mm²

Screwable cross-connection

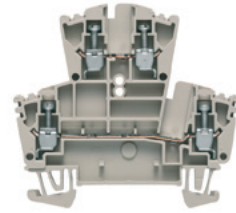

5.1 x 69 x 63.5	
32 / 4	
0.05...4	

IEC 60947-7-1 Ex e II  II 2 G D

IEC	UL	CSA	EN 60079-7
400	300 (C)	300 (C)	275
24	20 (C)	10 (C)	21
2.5	AWG 30...12	AWG 26...12	2.5
6 kV / 3			
A3 / V-0			

	KEMA 98ATEX1687 U
Rated connection	
Solid / stranded	0.5...4 / 1.5...4
Flexible / Flexible with ferrule	0.5...4 / 0.5...2.5
Tightening torque range (M 2.5)	
10 / 0.6 x 3.5 mm	
2 conductors with same cross-section	
Solid / stranded	0.5...1.5
Flexible / Flexible with ferrule	0.5...1.5 / 0.5...1.5
2.5 mm ² wires with wire ferrules including the plastic collar only clampable with diameter-optimised collar (Order no. 1333100000, pack of 500)	

Type	Qty.	Order No.
WDK 2.5	100	1021500000
WDK 2.5 BL	100	1021580000
For colour variants, refer to the W-Series accessories section, "Specific functions"		

Type	current	Qty.	Order No.
WQV 2.5/2	32 A	50	1053660000
WQV 2.5/3	32 A	50	1053760000
WQV 2.5/4	32 A	50	1053860000
WQV 2.5/10	32 A	20	1054460000
Width			
WAP WDK2.5	1.5 mm	20	1059100000
WAP WDK2.5 BL	1.5 mm	20	1059180000
WTW EN	3 mm	20	1058800000
Width			
WEW 35/1	12 mm	50	1059000000
Width			
WAD 4 GE BED	4.5 mm	50	1072000000
WAD 4 WS	4.5 mm	50	1072100000

DEK 5/5 / WS 8/5	Test plug and socket, see section "W-Series accessories" Ensure 2.5 mm ² max. when using the WQB.
------------------	---

WDK 2.5 V

2.5 mm²

Both levels at one potential

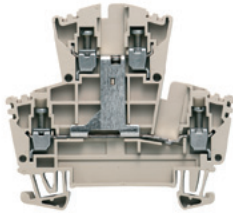

5.1 x 69.5 x 63.5
32 / 4
0.05...4

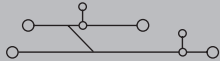

IEC 60947-7-1

Ex e II II 2 G D

IEC	UL	CSA	EN 60079-7
400	600 (C)	300 (C)	275
24	20 (C)	10 (C)	21
2.5	AWG 22...12	AWG 26...12	2.5

6 kV / 3
A3 / V-0

KEMA 98ATEX1687 U

Rated connection

0.5...4 / 1.5...4
0.5...4 / 0.5...2.5
0.4...0.6 Nm (M 2.5)
10 / 0.6 x 3.5 mm

0.5...1.5
0.5...1.5 / 0.5...1.5

2.5 mm² wires with wire ferrules including the plastic collar only clampable with diameter-optimised collar (Order no. 1333100000, pack of 500)

Type	Qty.	Order No.
WDK 2.5V	100	1022300000
WDK 2.5V BL	100	1022380000

For colour variants, refer to the section on W-Series accessories, "Specific functions"

Type	current	Qty.	Order No.
WQV 2.5/2	32 A	50	1053660000
WQV 2.5/3	32 A	50	1053760000
WQV 2.5/4	32 A	50	1053860000
WQV 2.5/10	32 A	20	1054460000
Width			
WAP WDK2.5	1.5 mm	20	1059100000
WAP WDK2.5 BL	1.5 mm	20	1059180000
WTW EN	3 mm	20	1058800000
WEW 35/1	12 mm	50	1059000000
WAD 4 GE BED	4.5 mm	50	1072000000
WAD 4 WS	4.5 mm	50	1072100000

DEK 5/5 / WS 8/5

Test plug and socket, see section "W-Series accessories"
Ensure 2.5 mm² max. when using the WQB.

WDK 2.5 DU-PE

2.5 mm²

Lower level earthed on terminal rail

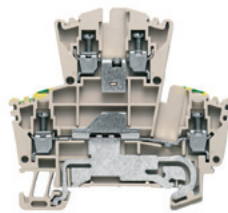

5.1 x 69.5 x 63.5
32 / 4
0.05...4

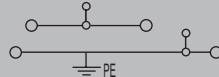

IEC 60947-7-1 (-7-2)

Ex e II II 2 G D

IEC	UL	CSA	EN 60079-7
400	300 (C)	300 (D)	275
24	20 (C)	20 (D)	21
2.5	AWG 22...12	AWG 22...12	2.5

6 kV / 3
A3 / V-0

KEMA 98ATEX1687 U

Rated connection

0.5...4 / 1.5...4
0.5...4 / 0.5...2.5
0.4...0.6 Nm (M 2.5)
10 / 0.6 x 3.5 mm

0.5...1.5
0.5...1.5 / 0.5...1.5

2.5 mm² wires with wire ferrules including the plastic collar only clampable with diameter-optimised collar (Order no. 1333100000, pack of 500)

Type	Qty.	Order No.
WDK 2.5DU-PE	100	1036400000

Type	current	Qty.	Order No.
WQV 2.5/2	32 A	50	1053660000
WQV 2.5/3	32 A	50	1053760000
WQV 2.5/4	32 A	50	1053860000
WQV 2.5/10	32 A	20	1054460000
Width			
WAP WDK2.5	1.5 mm	20	1059100000
WAP WDK2.5 BL	1.5 mm	20	1059180000
WTW EN	3 mm	20	1058800000
WEW 35/1	12 mm	50	1059000000
WAD 4 GE BED	4.5 mm	50	1072000000
WAD 4 WS	4.5 mm	50	1072100000

DEK 5/5 / WS 8/5

Test plug and socket, see section "W-Series accessories"
Ensure 2.5 mm² max. when using the WQB.

WDK 2.5 / 800 V

2.5 mm²

Rated voltage 800 V

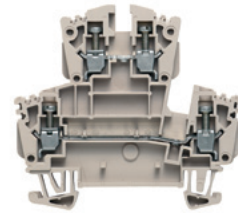

6.1 x 69 x 63.5
32 / 4
0.05...4

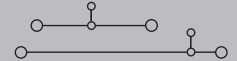

IEC 60947-7-1

Ex e II II 2 G D

IEC	UL	CSA	EN 60079-7
800			440
24			24
2.5		AWG 26...12	2.5

8 kV / 3
A3 / V-0

KEMA 98ATEX1685 U

Rated connection

0.5...4 / 1.5...4
0.5...4 / 0.5...2.5
0.4...0.6 Nm (M 2.5)
10 / 0.6 x 3.5 mm

0.5...1.5
0.5...1.5 / 0.5...1.5

Type	Qty.	Order No.
WDK 2.5/EX	100	1029100000

Type	current	Qty.	Order No.
Q 2 AKZ4SS	20 A	50	0369000000
Q 10 AKZ4SS	20 A	20	0369300000
Width			
WAP WDK2.5	1.5 mm	20	1059100000
WAP WDK2.5 BL	1.5 mm	20	1059180000
WAP 16+35 WTW 2.5-10	1.5 mm	20	1050100000
WEW 35/1	12 mm	50	1059000000
WAD 4 GE BED	4.5 mm	50	1072000000
WAD 4 WS	4.5 mm	50	1072100000

DEK 5/6 / WS 8/5

Test plug and socket, see section "W-Series accessories"
Ensure 2.5 mm² max. when using the WQB.

Double-level terminals

Identically contoured design of 2.5 to 10 mm² with identical end plates and partitions. An unmatched combination of many advantages!
The compact terminals are impressive for their small size and rated cross-section capacity.

In hazardous area applications, the installation instructions and the rated data specifications for accessories given in the technical appendix must be followed.

Width/Length/Height of lowest version	mm
max. current / max. cond. cross-section	A/mm ²
Max. clamping range	mm ²

Technical data

Rated data	
Rated voltage	V
Rated current	A
Rated cross-section	mm ²
Rated impulse withstand voltage / Pollution severity Gauge to IEC 60947-1 / Flammability class UL94	
Approvals	
Clamped conductors (H05V/H07V)	
Solid / stranded	mm ²
Flexible / Flexible with ferrule	mm ²
Tightening torque range (terminal screw)	
Stripping length / Blade size	mm/-
2 conductors with same cross-section (H05V/H07V)	
Solid / stranded	mm ²
Flexible / Flexible with ferrule	mm ²
Note	

Ordering data

Version	
	Dark beige Wemid
	Blue Wemid
Note	

Accessories

Pluggable cross-connection	
	2-pole
	3-pole
	4-pole
	10-pole
	20-/24-pole
Screwable cross-connection	
	2-pole
	3-pole
	4-pole
	10-pole
End plate / Partition plate	
	Dark beige Wemid
	Blue Wemid
	Dark beige Wemid
End bracket	
	Dark beige Wemid
Screwdriver	
	Standard
Cover	
	With lightning flash symbol
	Blank, white
Identification systems	
	(see assortment in catalogue 7)
	Marking tags
Note	

WDK 2.5N

2.5 mm²

Plug-in cross-connection
Compact design

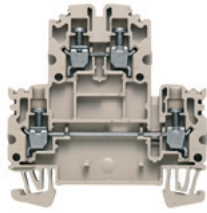

5.1 x 60.7 x 62.45	
28 / 4	
0.05...4	

IEC 60947-7-1				Ex e II II 2 G D	
IEC	UL	CSA	EN 60079-7		
800	600 (C)	300 (C)	550		
24	20 (C)	20 (C)	21		
2.5	AWG 26...12	AWG 26...12	2.5		
8 kV / 3					
A3 / V-0					
KEMA 00ATEX2061 U					
Rated connection					
0.5...4 / 1.5...4					
0.5...4 / 0.5...2.5					
0.4...0.6 Nm (M 2.5)					
8 / 0.6 x 3.5 mm					
0.5...1.5					
0.5...1.5 / 0.5...1.5					
The rated voltage is reduced to 400 V when using the cross-connection ZQV 2.5N.					

Type	Qty.	Order No.
WDK 2.5N	100	1041600000
WDK 2.5N BL	100	1041680000

Type	current	Qty.	Order No.
ZQV 2.5N/2 GE	24 A	60	1693800000
ZQV 2.5N/3 GE	24 A	60	1693810000
ZQV 2.5N/4 GE	24 A	60	1693820000
ZQV 2.5N/10 GE	24 A	20	1693880000
ZQV 2.5N/20 GE	24 A	20	1909000000
Width			
WAP WDK2.5/4 N	1.5 mm	20	1084000000
WAP WDK2.5/4 N BL	1.5 mm	20	1084080000
WTW EN	3 mm	20	1058800000
WEW 35/1	12 mm	50	1059000000
Identification systems			
DEK 5/5 / WS 8/5			
Note			

WDK 2.5N V

2.5 mm²

Both levels at one potential
Compact design

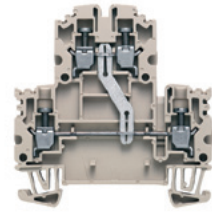

5.1 x 60.7 x 62.45	
28 / 4	
0.05...4	

IEC 60947-7-1				Ex e II II 2 G D	
IEC	UL	CSA	EN 60079-7		
800	600 (C)	300 (C)	550		
24	20 (C)	20 (C)	21		
2.5	AWG 26...12	AWG 26...12	2.5		
8 kV / 3					
A3 / V-0					
KEMA 00ATEX2061 U					
Rated connection					
0.5...4 / 1.5...4					
0.5...4 / 0.5...2.5					
0.4...0.6 Nm (M 2.5)					
8 / 0.6 x 3.5 mm					
0.5...1.5					
0.5...1.5 / 0.5...1.5					
The rated voltage is reduced to 400 V when using the cross-connection ZQV.					

Type	Qty.	Order No.
WDK 2.5N V	100	1041610000

Type	current	Qty.	Order No.
ZQV 2.5N/2 GE	24 A	60	1693800000
ZQV 2.5N/3 GE	24 A	60	1693810000
ZQV 2.5N/4 GE	24 A	60	1693820000
ZQV 2.5N/10 GE	24 A	20	1693880000
ZQV 2.5N/20 GE	24 A	20	1909000000
Width			
WAP WDK2.5/4 N	1.5 mm	20	1084000000
WAP WDK2.5/4 N BL	1.5 mm	20	1084080000
WTW EN	3 mm	20	1058800000
WEW 35/1	12 mm	50	1059000000
Identification systems			
DEK 5/5 / WS 8/5			
Note			

WDK 2.5N DU-PE

2.5 mm²

Lower level earthed on terminal rail
Compact design

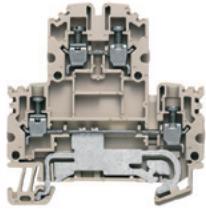

5.1 x 60.7 x 62.45
28 / 4
0.05...4

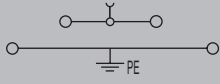

IEC 60947-7-1 (-7-2)

Ex e II II 2 G D

IEC	UL	CSA	EN 60079-7
800	600 (C)	600 (D)	550
24	20 (C)	5 (D)	21
2.5	AWG 26...12	AWG 26...12	2.5
8 kV / 3			
A3 / V-0			

KEMA 00ATEX2061 U

Rated connection

0.5...4 / 1.5...4
0.5...4 / 0.5...2.5
0.4...0.6 Nm (M 2.5)
8 / 0.6 x 3.5 mm

0.5...1.5
0.5...1.5 / 0.5...1.5

The rated voltage is reduced to 400 V when using the cross-connection ZQV. It is prohibited to connect two conductors via the PE connection!

Type	Qty.	Order No.
WDK 2.5N DU-PE	100	1041650000

Type	current	Qty.	Order No.
ZQV 2.5N/2 GE	24 A	60	1693800000
ZQV 2.5N/3 GE	24 A	60	1693810000
ZQV 2.5N/4 GE	24 A	60	1693820000
ZQV 2.5N/10 GE	24 A	20	1693880000
ZQV 2.5N/20 GE	24 A	20	1909000000

Width			
WAP WDK2.5/4 N	1.5 mm	20	1084000000
WAP WDK2.5/4 N BL	1.5 mm	20	1084080000
WTW EN	3 mm	20	1058800000

WEW 35/1 12 mm 50 **1059000000**

DEK 5/5 / WS 8/5

WDK 4N

4 mm²

Plug-in cross-connection
Compact design

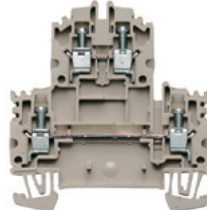

6.1 x 60 x 64.15
35 / 6
0.13...6

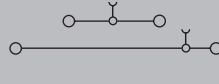

IEC 60947-7-1

Ex e II II 2 G D

IEC	UL	CSA	EN 60079-7
800	600 (C)	300 (C)	550
32	35 (C)	30 (C)	28
4	AWG 26...10	AWG 26...10	4
8 kV / 3			
A4 / V-0			

KEMA 00ATEX2061 U

Rated connection

0.5...6 / 1.5...6
0.5...4 / 0.5...4
0.5...1 Nm (M 3)
8 / 0.6 x 3.5 mm

0.5...1.5
0.5...1.5 / 0.5...1.5

Rated voltage: 400 V when using ZQV cross-connection 2 wire H07V-U1.5, tighten with 0.6 Nm.

Type	Qty.	Order No.
WDK 4N	100	1041900000
WDK 4N BL	100	1041980000

Type	current	Qty.	Order No.
ZQV 4N/2 GE	32 A	60	1758250000
ZQV 4N/3 GE	32 A	60	1762630000
ZQV 4N/4 GE	32 A	60	1762620000
ZQV 4N/10 GE	32 A	20	1758260000
ZQV 4N/20 GE	32 A	20	1909020000

Width			
WAP WDK2.5/4 N	1.5 mm	20	1084000000
WAP WDK2.5/4 N BL	1.5 mm	20	1084080000
WTW EN	3 mm	20	1058800000

WEW 35/1 12 mm 50 **1059000000**

DEK 5/6 / WS 8/6

Test plug and socket, see section "W-Series accessories" Ensure 2.5 mm² max. when using the WQB.

WDK 4N V

4 mm²

Both levels at one potential
Compact design

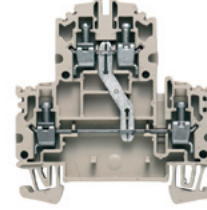

6.1 x 60.7 x 64.15
35 / 6
0.13...6

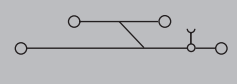

IEC 60947-7-1

Ex e II II 2 G D

IEC	UL	CSA	EN 60079-7
800	600 (C)	300 (C)	550
32	35 (C)	30 (C)	28
4	AWG 26...10	AWG 26...10	4
8 kV / 3			
A4 / V-0			

KEMA 00ATEX2061 U

Rated connection

0.5...6 / 1.5...6
0.5...4 / 0.5...4
0.5...1 Nm (M 3)
8 / 0.6 x 3.5 mm

0.5...1.5
0.5...1.5 / 0.5...1.5

Rated voltage: 400 V when using ZQV cross-connection 2 wire H07V-U1.5, tighten with 0.6 Nm.

Type	Qty.	Order No.
WDK 4N V	100	1041910000

Type	current	Qty.	Order No.
ZQV 4N/2 GE	32 A	60	1758250000
ZQV 4N/3 GE	32 A	60	1762630000
ZQV 4N/4 GE	32 A	60	1762620000
ZQV 4N/10 GE	32 A	20	1758260000
ZQV 4N/20 GE	32 A	20	1909020000

Width			
WAP WDK2.5/4 N	1.5 mm	20	1084000000
WAP WDK2.5/4 N BL	1.5 mm	20	1084080000
WTW EN	3 mm	20	1058800000

WEW 35/1 12 mm 50 **1059000000**

DEK 5/6 / WS 8/6

Test plug and socket, see section "W-Series accessories" Ensure 2.5 mm² max. when using the WQB.

Double-level terminals

Identically contoured design of 2.5 to 10 mm² with identical end plates and partitions. An unmatched combination of many advantages!

The compact terminals are impressive for their small size and rated cross-section capacity.

In hazardous area applications, the installation instructions and the rated data specifications for accessories given in the technical appendix must be followed.

Width/Length/Height of lowest version	mm
max. current / max. cond. cross-section	A/mm ²
Max. clamping range	mm ²



Technical data

Rated data	
Rated voltage	V
Rated current	A
Rated cross-section	mm ²
Rated impulse withstand voltage / Pollution severity	Gauge to IEC 60947-1 / Flammability class UL94
Approvals	
Clamped conductors (H05V/H07V)	
Solid / stranded	mm ²
Flexible / Flexible with ferrule	mm ²
Tightening torque range (terminal screw)	
Stripping length / Blade size	mm/-
2 conductors with same cross-section (H05V/H07V)	
Solid / stranded	mm ²
Flexible / Flexible with ferrule	mm ²
Note	

Ordering data

Version	
	Dark beige Wemid
	Blue Wemid
Note	

Accessories

Pluggable cross-connection	
	2-pole
	3-pole
	4-pole
	10-pole
	20-/24-pole
Screwable cross-connection	
	2-pole
	3-pole
	4-pole
	10-pole
End plate / Partition plate	
	Dark beige Wemid
	Blue Wemid
	Dark beige Wemid
End bracket	
	Dark beige Wemid
Screwdriver	
	Standard
Cover	
	With lightning flash symbol
	Blank, white
Identification systems	
	(see assortment in catalogue 7)
	Marking tags
Note	

WDK 4N DU-PE

4 mm²

Lower level earthed on terminal rail
Compact design

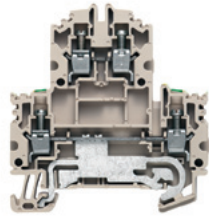

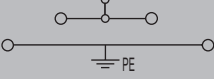
6.1 x 60.7 x 64.15	
35 / 6	
0.13...6	

 IEC 60947-7-1 (-7-2) Ex e II  II 2 G D

IEC	UL	CSA	EN 60079-7
800	600 (C)	300 (C)	550
32	35 (C)	30 (C)	28
4	AWG 26...10	AWG 26...10	4
8 kV / 3			
A4 / V-0			

 KEMA 00ATEX2061 U

Rated connection	
0.5...6 / 1.5...6	
0.5...4 / 0.5...4	
0.5...1 Nm (M 3)	
8 / 0.6 x 3.5 mm	
0.5...1.5	
0.5...1.5 / 0.5...1.5	
Rated voltage is 400 V when using the ZQV cross-connector. It is prohibited to connect two conductors via the PE connection!	

Type	Qty.	Order No.
WDK 4N DU-PE	100	1041950000

Type	current	Qty.	Order No.
ZQV 4N/2 GE	32 A	60	1758250000
ZQV 4N/3 GE	32 A	60	1762630000
ZQV 4N/4 GE	32 A	60	1762620000
ZQV 4N/10 GE	32 A	20	1758260000
ZQV 4N/20 GE	32 A	20	1909020000
Width			
WAP WDK2.5/4 N	1.5 mm	20	1084000000
WAP WDK2.5/4 N BL	1.5 mm	20	1084080000
WTW EN	3 mm	20	1058800000
WEW 35/1	12 mm	50	1059000000

DEK 5/6 / WS 8/6
Test plug and socket, see section "W-Series accessories" Ensure 2.5 mm ² max. when using the WQB.

In hazardous area applications, the installation instructions and the rated data specifications for accessories given in the technical appendix must be followed.

Width/Length/Height of lowest version	mm
max. current / max. cond. cross-section	A/mm ²
Max. clamping range	mm ²



Technical data

Rated data	
Rated voltage	V
Rated current	A
Rated cross-section	mm ²
Rated impulse withstand voltage / Pollution severity Gauge to IEC 60947-1 / Flammability class UL94	
Approvals	
Clamped conductors (H05V/H07V)	
Solid / stranded	mm ²
Flexible / Flexible with ferrule	mm ²
Tightening torque range (terminal screw)	
Stripping length / Blade size	mm/-
2 conductors with same cross-section (H05V/H07V)	
Solid / stranded	mm ²
Flexible / Flexible with ferrule	mm ²
Note	

Ordering data

Version	
	Dark beige Wemid
	Blue Wemid
Note	

Accessories



Pluggable cross-connection	
	2-pole
	3-pole
	4-pole
	10-pole
	20-/24-pole
Screwable cross-connection	
	2-pole
	3-pole
	4-pole
	10-pole
End plate / Partition plate	
	Dark beige Wemid
	Blue Wemid
	Dark beige Wemid
End bracket	
	Dark beige Wemid
Screwdriver	
	Standard
Cover	
	With lightning flash symbol
	Blank, white
Identification systems (see assortment in catalogue 7)	
	Marking tags
Note	

WDK 10

10 mm²

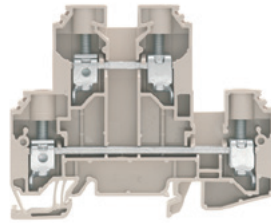
NEW

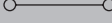

9.9 x 85 x 69.5	
76 / 16	
1.5...16	

IEC 60947-7-1

IEC	UL	CSA
800	600 (C)	600 (C)
57	64 (C)	64 (C)
10	AWG 18...6	AWG 18...6
8 kV / 3		
B6 / V-0		
UL		
Rated connection		
1.5...16 / 1.5...16		
1.5...16 / 1.5...16		
1.5...2.4 Nm (M 4)		
12 / 1.0 x 5.5 mm		
Note		

Type	Qty.	Order No.
WDK 10	50	1186740000
WDK 10 BL	50	1186750000
Note		

Type	current	Qty.	Order No.
WQV 10/2	57 A	50	1052560000
WQV 10/3	57 A	50	1054960000
WQV 10/4	57 A	50	1055060000
WQV 10/10	57 A	20	1052460000
Width			
WAP WDK10	1.5 mm	20	1186720000
WAP WDK10 BL	1.5 mm	20	1186730000
Note			
WEW 35/1	12 mm	50	1059000000
SDS 1.0X5.5X150		1	9008350000
Note			

Note	
DEK 5/5	

WDK 10 V

10 mm²

NEW

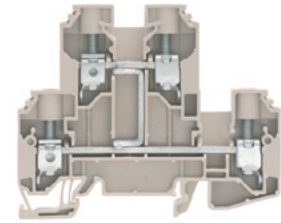

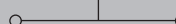
9.9 x 85 x 69.5	
76 / 16	
1.5...16	

IEC 60947-7-1

IEC	UL	CSA
800	600 (C)	600 (C)
57	49 (C)	49 (C)
10	AWG 18...6	AWG 18...6
8 kV / 3		
B6 / V-0		
UL		
Rated connection		
1.5...16 / 1.5...16		
1.5...16 / 1.5...16		
1.5...2.4 Nm (M 4)		
12 / 1.0 x 5.5 mm		
Note		

Type	Qty.	Order No.
WDK 10 V	50	1186770000
WDK 10 V BL	50	1186780000
Note		

Type	current	Qty.	Order No.
WQV 10/2	57 A	50	1052560000
WQV 10/3	57 A	50	1054960000
WQV 10/4	57 A	50	1055060000
WQV 10/10	57 A	20	1052460000
Width			
WAP WDK10	1.5 mm	20	1186720000
WAP WDK10 BL	1.5 mm	20	1186730000
Note			
WEW 35/1	12 mm	50	1059000000
SDS 1.0X5.5X150		1	9008350000
Note			

Note	
DEK 5/5	

PE terminals

Identically contoured design of 2.5 to 10 mm² with identical end plates and partitions. An unmatched combination of many advantages!
The compact terminals are impressive for their small size and rated cross-section capacity.

In hazardous area applications, the installation instructions and the rated data specifications for accessories given in the technical appendix must be followed.

Width/Length/Height of lowest version	mm
max. cond. cross-section	mm ²
Max. clamping range	mm ²

Technical data

Rated data	
Rated cross-section	mm ²
Rated voltage to adjoining terminal	V
Rated impulse withstand voltage to adjacent terminal	kV
Rated short-time current	
Pollution severity	
Gauge to IEC 60947-1 / Flammability class UL94	
Approvals	

Clamped conductors (H05V/H07V)	
Solid / stranded	mm ²
Flexible / Flexible with ferrule	mm ²
Tightening torque range (terminal screw)	
Tightening torque range for fixing screw	
Stripping length / Blade size	mm/-

Note

Ordering data

Version	green/yellow Wemid
Note	

Accessories

Pluggable cross-connection	
	2-pole 3-pole 4-pole 10-pole 20-/24-pole
End plate / Partition plate	
	Dark beige Wemid Blue Wemid Dark beige Wemid
End bracket	
	Dark beige Wemid
Screwdriver	
	Standard

Identification systems	(see assortment in catalogue 7) Marking tags
Note	

WPE 1.5/ZZ

1.5 mm²

Twin connection

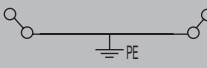

5.1 x 60 x 47	
2.5	
0.13...2.5	

IEC 60947-7-2 Ex e II  II 2 G D

IEC	UL	CSA	EN 60079-7
1.5	AWG 22...14	AWG 26...14	1.5
800			
8			
	180 A (1.5 mm ²)		
	3		
	A1 / V-0		

Rated connection		Further connection	
0.5...2.5 / 1.5...2.5		0.5...2.5 / 1.5...2.5	
0.5...1.5 / 0.5...1.5			
0.4...0.6 Nm (M 2.5)			
0.4...0.6 Nm (M 2.5)			
7 / 0.6 x 3.5 mm		7 / 0.6 x 3.5 mm	

Type	Qty.	Order No.
WPE 1.5/ZZ	100	1016500000

Type	current	Qty.	Order No.
Width			
WAP 2.5-10	1.5 mm	50	1050000000
Width			
WEW 35/2	8 mm	100	1061200000
SDS 0.6X3.5X100		1	9008330000

Type	current	Qty.	Order No.
DEK 5/5 / WS 12/5			
Rail holder for protective isolation Installation of the mounting rail "SH 2" Order no. 0494920000 (qty. 10).			

WPE 2.5/1.5/ZR

2.5 mm²

Supplementary connection, right (1.5 mm²)

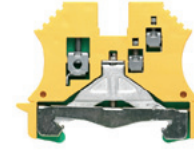

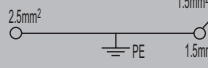
5.1 x 60 x 47	
4	
0.05...4	

IEC 60947-7-2 Ex e II  II 2 G D

IEC	UL	CSA	EN 60079-7
2.5	AWG 22...12	AWG 26...12	2.5
800			
8			
	300 A (2.5 mm ²)		
	3		
	A3 / V-0		

Rated connection		Further connection	
0.5...4 / 1.5...4		0.5...2.5	
0.5...4 / 0.5...2.5			
0.4...0.6 Nm (M 2.5)			
0.4...0.6 Nm (M 2.5)			
10 / 0.6 x 3.5 mm		10 / 0.6 x 3.5 mm	

2.5 mm² wires with wire ferrules including the plastic collar only clampable with diameter-optimised collar (Order no. 1333100000, pack of 500)

Type	Qty.	Order No.
WPE 2.5/1.5/ZR	100	1016400000

Type	current	Qty.	Order No.
Width			
WAP 2.5-10	1.5 mm	50	1050000000
Width			
WEW 35/2	8 mm	100	1061200000
SDS 0.6X3.5X100		1	9008330000

Type	current	Qty.	Order No.
DEK 5/5 / WS 12/5			
Rail holder for protective isolation Installation of the mounting rail "SH 2" Order no. 0494920000 (qty. 10).			

WPE 2.5

2.5 mm²

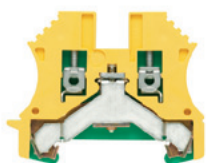

5.1 x 60 x 47
4
0.05...4



IEC 60947-7-2

Ex e II II 2 G D

IEC	UL	CSA	EN 60079-7
2.5	AWG 22...12	AWG 26...12	2.5
800			
8			
300 A (2.5 mm ²)			
3			
A3 / V-0			



Rated connection	Further connection
0.5...4 / 1.5...4	
0.5...4 / 0.5...2.5	
0.4...0.6 Nm (M 2.5)	
0.4...0.8 Nm (M 2.5)	
10 / 0.6 x 3.5 mm	

2.5 mm² wires with wire ferrules including the plastic collar only clampable with diameter-optimised collar (Order no. 1333100000, pack of 500)

Type	Qty.	Order No.
WPE 2.5	100	101000000

Type	current	Qty.	Order No.
WAP 2.5-10	1.5 mm	50	105000000
WEW 35/2	8 mm	100	106120000
SDS 0.6X3.5X100		1	900833000

DEK 5/5 / WS 12/5

Rail holder for protective isolation Installation of the mounting rail "SH 2" Order no. 0494920000 (qty. 10).

WPE 2.5N

2.5 mm²



5.1 x 54 x 37.5
4
0.05...4



IEC 60947-7-2

Ex e II II 2 G D

IEC	UL	CSA	EN 60079-7
2.5	AWG 26...12	AWG 26...12	2.5
500			
6			
300 A (2.5 mm ²)			
3			
A3 / V-0			



Rated connection	Further connection
0.5...4 / 1.5...4	
0.5...4 / 0.5...2.5	
0.4...0.6 Nm (M 2.5)	
0.4...0.8 Nm (M 2.5)	
10 / 0.6 x 3.5 mm	

2.5 mm² wires with wire ferrules including the plastic collar only clampable with diameter-optimised collar (Order no. 1333100000, pack of 500)

Type	Qty.	Order No.
WPE 2.5N	100	101620000

Type	current	Qty.	Order No.
WAP WDU2.5N/4N	1.5 mm	50	106000000
WEW 35/2	8 mm	100	106120000
SDS 0.6X3.5X100		1	900833000

DEK 5/5 / WS 12/5

Rail holder for protective isolation Installation of the mounting rail "SH 2" Order no. 0494920000 (qty. 10).

WDK 2.5 PE

2.5 mm²

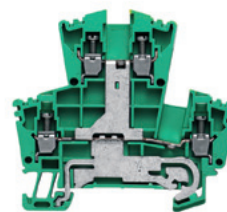

5.1 x 69.5 x 63.5
4
0.05...4

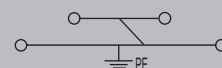

IEC 60947-7-2

Ex e II II 2 G D

IEC	UL	CSA	EN 60079-7
2.5	AWG 22...12	AWG 26...12	2.5
400			
6			
300 A (2.5 mm ²)			
3			
A3 / V-0			



Rated connection	Further connection
0.5...4 / 1.5...4	
0.5...4 / 0.5...2.5	
0.4...0.6 Nm (M 2.5)	
10 /	

2.5 mm² wires with wire ferrules including the plastic collar only clampable with diameter-optimised collar (Order no. 1333100000, pack of 500)

Type	Qty.	Order No.
WDK 2.5PE	100	103630000

Type	current	Qty.	Order No.
WAP WDK2.5	1.5 mm	20	105910000
WEW 35/2	8 mm	100	106120000
SDS 0.6X3.5X100		1	900833000

DEK 5/5 / WS 8/5

Rail holder for protective isolation Installation of the mounting rail "SH 2" Order no. 0494920000 (qty. 10).

PE terminals

Identically contoured design of 2.5 to 10 mm² with identical end plates and partitions. An unmatched combination of many advantages!
The compact terminals are impressive for their small size and rated cross-section capacity.

In hazardous area applications, the installation instructions and the rated data specifications for accessories given in the technical appendix must be followed.

Width/Length/Height of lowest version	mm
max. cond. cross-section	mm ²
Max. clamping range	mm ²

Technical data

Rated data	
Rated cross-section	mm ²
Rated voltage to adjoining terminal	V
Rated impulse withstand voltage to adjacent terminal	kV
Rated short-time current	
Pollution severity	
Gauge to IEC 60947-1 / Flammability class UL94	
Approvals	

Clamped conductors (H05V/H07V)





Solid / stranded	mm ²
Flexible / Flexible with ferrule	mm ²
Tightening torque range (terminal screw)	
Tightening torque range for fixing screw	
Stripping length / Blade size	mm/-

Note

Ordering data

Version	
	green/yellow Wemid
Note	

Accessories

Pluggable cross-connection	
	2-pole
	3-pole
	4-pole
	10-pole
	20-/24-pole
End plate / Partition plate	
	Dark beige Wemid
	Blue Wemid
	Dark beige Wemid
End bracket	
	Dark beige Wemid
Screwdriver	
	Standard

Identification systems	(see assortment in catalogue 7)
	Marking tags
Note	

WDK 2.5N PE

2.5 mm²

Compact design

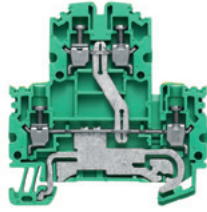

5.1 x 60.7 x 62.45	
4	
0.05...4	

IEC 60947-7-2 Ex e II  II 2 G D

IEC	UL	CSA	EN 60079-7
2.5	AWG 26...12	AWG 26...12	2.5
800			
8			
	300 A (2.5 mm ²)		
	3		
	A3 / V-0		

Further connection	
Rated connection	
0.5...4 / 1.5...4	
0.5...4 / 0.5...2.5	
0.4...0.6 Nm (M 2.5)	
8 / 0.6 x 3.5 mm	
2.5 mm ² wires with wire ferrules including the plastic collar only clampable with diameter-optimised collar (Order no. 1333100000, pack of 500)	

Type	Qty.	Order No.
WDK 2.5N PE	100	1041620000

Type	current	Qty.	Order No.
ZQV 2.5N/2 GE	24 A	60	1693800000
ZQV 2.5N/3 GE	24 A	60	1693810000
ZQV 2.5N/4 GE	24 A	60	1693820000
ZQV 2.5N/10 GE	24 A	20	1693880000
ZQV 2.5N/20 GE	24 A	20	1909000000
Width			
WAP WDK2.5/4 N	1.5 mm	20	1084000000
WAP WDK2.5/4 N BL	1.5 mm	20	1084080000
WTW EN	3 mm	20	1058800000
Width			
WEW 35/2	8 mm	100	1061200000
SDS 0.6X3.5X100		1	9008330000

Type	current	Qty.	Order No.
DEK 5/5 / WS 8/5			
Rail holder for protective isolation Installation of the mounting rail "SH 2" Order no. 0494920000 (qty. 10).			

WPE 4

4 mm²



6.1 x 56 x 47.5	
6	
0.13...6	

IEC 60947-7-2 Ex e II  II 2 G D

IEC	UL	CSA	EN 60079-7
4	AWG 22...10	AWG 26...10	4
800			
8			
	480 A (4 mm ²)		
	3		
	A4 / V-0		

Further connection	
Rated connection	
0.5...6 / 0.5...6	
0.5...6 / 0.5...4	
0.5...1 Nm (M 3)	
0.5...1.0 Nm (M 3)	
10 / 0.6 x 3.5 mm	

Type	Qty.	Order No.
WPE 4	100	1010100000

Type	current	Qty.	Order No.
WEW 35/2	8 mm	100	1061200000
SDS 0.6X3.5X100		1	9008330000

Type	current	Qty.	Order No.
DEK 5/6			
Rail holder for protective isolation Installation of the mounting rail "SH 2" Order no. 0494920000 (qty. 10).			

WPE 4/ZZ

4 mm²

Twin connection

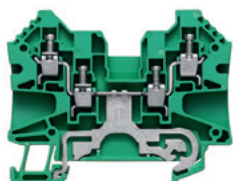

6.1 x 70 x 53
6
0.05...6

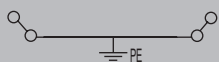

IEC 60947-7-2

Ex e II II 2 G D

IEC	UL	CSA	EN 60079-7
4	AWG 30...10	AWG 30...10	4
800			
8			
480 A (4 mm ²)			
3			
A4 / V-0			



Rated connection	Further connection
0.5...6 / 0.5...4	0.5
0.5...4 / 0.5...4	
0.5...0.8 Nm (M 3)	

10 / 0.6 x 3.5 mm 10 / 0.6 x 3.5 mm

Type	Qty.	Order No.
WPE 4/ZZ	50	1905130000

Type	current	Qty.	Order No.
Width			
WAP WDU/WTR4/ZZ	1.5 mm	50	1905150000
Width			
WEW 35/2	8 mm	100	1061200000
SDS 0.6X3.5X100		1	9008330000

DEK 5/6

Rail holder for protective isolation Installation of the mounting rail "SH 2" Order no. 0494920000 (qty. 10).

WPE 4/ZR

4 mm²

Supplementary connection, right

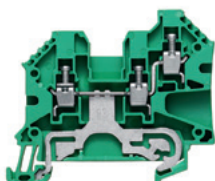

6.1 x 63.5 x 53.3
6
0.05...6

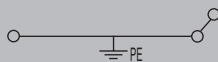

IEC 60947-7-2

Ex e II II 2 G D

IEC	UL	CSA	EN 60079-7
4	AWG 30...10	AWG 30...10	4
800			
8			
480 A (4 mm ²)			
3			
A4 / V-0			



Rated connection	Further connection
0.5...6 / 0.5...4	0.5...6
0.5...2.5 / 0.5...4	
0.5...0.8 Nm (M 3)	

10 / 0.6 x 3.5 mm 10 / 0.6 x 3.5 mm

Type	Qty.	Order No.
WPE 4/ZR	50	1905120000

Type	current	Qty.	Order No.
Width			
WAP WDU/WTR4/ZR	1.5 mm	50	1905070000
Width			
WEW 35/2	8 mm	100	1061200000
SDS 0.6X3.5X100		1	9008330000

DEK 5/6

Rail holder for protective isolation Installation of the mounting rail "SH 2" Order no. 0494920000 (qty. 10).

WPE 4N

4 mm²

Compact design

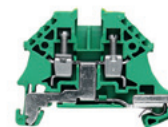

6.1 x 50 x 38.5
6
0.13...6



IEC 60947-7-2

Ex e II II 2 G D

IEC	UL	CSA	EN 60079-7
4	AWG 26...10	AWG 26...10	4
500			
6			
480 A (4 mm ²)			
3			
A3 / V-0			



Rated connection	Further connection
0.5...6 / 1.5...6	
0.5...4 / 0.5...4	
0.5...1 Nm (M 3)	

10 / 0.6 x 3.5 mm

Type	Qty.	Order No.
WPE 4N	100	1042700000

Type	current	Qty.	Order No.
Width			
WAP WDU2.5N/4N	1.5 mm	50	1060000000
Width			
WEW 35/2	8 mm	100	1061200000
SDS 0.6X3.5X100		1	9008330000

DEK 5/6 / WS 12/6

Rail holder for protective isolation Installation of the mounting rail "SH 2" Order no. 0494920000 (qty. 10).

PE terminals

Identically contoured design of 2.5 to 10 mm² with identical end plates and partitions. An unmatched combination of many advantages!

The compact terminals are impressive for their small size and rated cross-section capacity.

In hazardous area applications, the installation instructions and the rated data specifications for accessories given in the technical appendix must be followed.

Width/Length/Height of lowest version	mm
max. cond. cross-section	mm ²
Max. clamping range	mm ²

Technical data

Rated data	
Rated cross-section	mm ²
Rated voltage to adjoining terminal	V
Rated impulse withstand voltage to adjacent terminal	kV
Rated short-time current	
Pollution severity	
Gauge to IEC 60947-1 / Flammability class UL94	
Approvals	

Clamped conductors (H05V/H07V)

Solid / stranded	mm ²
Flexible / Flexible with ferrule	mm ²
Tightening torque range (terminal screw)	
Tightening torque range for fixing screw	
Stripping length / Blade size	mm/-

Note

Ordering data

Version
green/yellow Wemid
Note

Accessories

Pluggable cross-connection	
	2-pole
	3-pole
	4-pole
	10-pole
	20-/24-pole
End plate / Partition plate	
	Dark beige Wemid
	Blue Wemid
	Dark beige Wemid
End bracket	
	Dark beige Wemid
Screwdriver	
	Standard

Identification systems (see assortment in catalogue 7)

Marking tags

Note

WDK 4N PE

4 mm²

Compact design

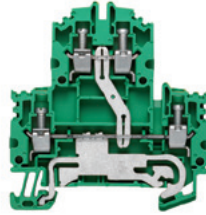

6.1 x 60.7 x 64.15

6

0.13...6

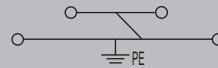

IEC 60947-7-2

Ex e II



II 2 G D

IEC	UL	CSA	EN 60079-7
4	AWG 26...10	AWG 26...10	4
800			
8			
480 A (4 mm ²)			
3			
A3 / V-0			

Rated connection	Further connection
0.5...6 / 1.5...6	
0.5...4 / 0.5...4	
0.5...1 Nm (M 3)	
8 / 0.6 x 3.5 mm	

Type	Qty.	Order No.
WDK 4N PE	100	1041920000

Type	current	Qty.	Order No.
Width			
WAP WDK2.5/4 N	1.5 mm	20	1084000000
WEW 35/2			
	8 mm	100	1061200000
SDS 0.6X3.5X100			
		1	9008330000

DEK 5/6 / WS 8/6

Rail holder for protective isolation Installation of the mounting rail "SH 2" Order no. 0494920000 (qty. 10).

Identically contoured design of 2.5 to 10 mm² with identical end plates and partitions. An unmatched combination of many advantages!
The compact terminals are impressive for their small size and rated cross-section capacity.

In hazardous area applications, the installation instructions and the rated data specifications for accessories given in the technical appendix must be followed.

Width/Length/Height of lowest version	mm
max. cond. cross-section	mm ²
Max. clamping range	mm ²

Technical data

Rated data	
Rated cross-section	mm ²
Rated voltage to adjoining terminal	V
Rated impulse withstand voltage to adjacent terminal	kV
Rated short-time current	
Pollution severity	
Gauge to IEC 60947-1 / Flammability class UL94	

Approvals

Clamped conductors (H05V/H07V)

Solid / stranded	mm ²
Flexible / Flexible with ferrule	mm ²
Tightening torque range (terminal screw)	
Tightening torque range for fixing screw	
Stripping length / Blade size	mm/-

Note

Ordering data

Version	
	green/yellow Wemid

Note

Accessories

PEN bridge	
End bracket	Dark beige Wemid
Screwdriver	Standard

Identification systems (see assortment in catalogue 7)

Note	Marking tags
-------------	--------------

WPE 6

6 mm²



7.9 x 56 x 47	
10	
0.08...10	

IEC 60947-7-2 Ex e II II 2 G D

IEC	UL	CSA	EN 60079-7
6	AWG 20...8	AWG 20...8	66
800			
8			
	720 A (6 mm ²)		
	3		
	A5 / V-0		

Rated connection	Further connection
0.5...10 / 1.5...10	
0.5...10 / 0.5...6	
0.8...1.3 Nm (M 3)	
0.5...1.0 Nm (M 3)	
12 / 4.0 x 0.8 mm	

Conductor connection H07V...10 and AWG 8 tighten with 1.4-1.6 Nm.

Type	Qty.	Order No.
WPE 6	50	1010200000

Type	Width	Qty.	Order No.
WEW 35/2	8 mm	100	1061200000
SDS 0.8X4.0X100		1	9008340000

DEK 5/8 / WS 12/6,5	
Rail holder for protective isolation Installation of the mounting rail "SH 2" Order no. 0494920000 (qty. 10).	

WPE 10

10 mm²



9.9 x 60 x 47	
16	
1.31...16	

IEC 60947-7-2 Ex e II II 2 G D

IEC	UL	CSA	EN 60079-7
10	AWG 16...6	AWG 16...6	1010
1000			
8			
	1200 A (10 mm ²)		
	3		
	B6 / V-0		

Rated connection	Further connection
1.5...16 / 1.5...16	
1.5...16 / 1.5...16	
1.2...2.4 Nm (M 4)	
0.5...1.0 Nm (M 3)	
12 / 1.0 x 5.5 mm	

AWG 6/7 and H07V-R16 tighten with 2.4 Nm.

Type	Qty.	Order No.
WPE 10	50	1010300000

Type	Width	Qty.	Order No.
WQB-PEN 10	14.8 mm	10	1060300000
WEW 35/2	8 mm	100	1061200000
SDS 1.0X5.5X150		1	9008350000

DEK 5/5 / WS 12/6,5	
Rail holder for protective isolation Installation of the mounting rail "SH 2" Order no. 0494920000 (qty. 10).	

PE terminals

Identically contoured design of 2.5 to 10 mm² with identical end plates and partitions. An unmatched combination of many advantages!
The compact terminals are impressive for their small size and rated cross-section capacity.

In hazardous area applications, the installation instructions and the rated data specifications for accessories given in the technical appendix must be followed.

Width/Length/Height of lowest version	mm
max. cond. cross-section	mm ²
Max. clamping range	mm ²

Technical data

Rated data	
Rated cross-section	mm ²
Rated voltage to adjoining terminal	V
Rated impulse withstand voltage to adjacent terminal	kV
Rated short-time current	
Pollution severity	
Gauge to IEC 60947-1 / Flammability class UL94	
Approvals	

Clamped conductors (H05V/H07V)

Solid / stranded	mm ²
Flexible / Flexible with ferrule	mm ²
Tightening torque range (terminal screw)	
Tightening torque range for fixing screw	
Stripping length / Blade size	mm/-

Note

Ordering data

Version	
	green/yellow Wemid
Note	

Accessories

PEN bridge	
End bracket	Dark beige Wemid
Screwdriver	Standard

Identification systems (see assortment in catalogue 7)

Marking tags

Note

WPE 10/ZR

10 mm²

Supplementary connection, right (4 mm²)

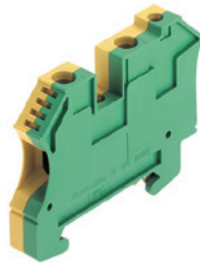

9.9 x 66 x 49.5
16
1.31...16

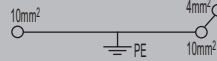

IEC 60947-7-2

IEC	UL	CSA
10	AWG 16...6	AWG 14...6
1000		
8		
	1200 A (10 mm ²)	
	3	
	B6, A4 / V-0	



Rated connection	Further connection
1.5...16 / 1.5...16	0.5...6 / 1.5...4
1.5...16 / 1.5...16	0.5...4 / 1.5...16
1.2...2.4 Nm (M 4)	
0.5...1.0 Nm (M 3)	
12 / 0.6 x 3.5 mm	10 / 0.6 x 3.5 mm

Max. conductor cross-sections refer to 10 mm² and 16 mm² connections. AWG 6/7 and H07V-R16 tighten with 2.4 Nm.

Type	Qty.	Order No.
WPE 10/ZR	50	1042500000

Type	Width	Qty.	Order No.
WQB-PEN 10	14.8 mm	10	1060300000
WEW 35/2	8 mm	100	1061200000
SDS 0.6X3.5X100		1	9008330000

DEK 5/5 / WS 12/6,5

Rail holder for protective isolation Installation of the mounting rail "SH 2" Order no. 0494920000 (qty. 10).

WPE 16

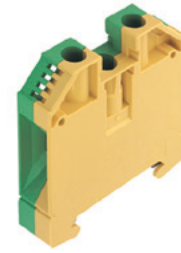
16 mm²

11.9 x 56 x 63
25
1.5...25

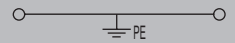

IEC 60947-7-2

Ex e II II 2 G D

IEC	UL	CSA	EN 60079-7
16	AWG 14...4	AWG 14...6	1616
1000			
8			
	1920 A (16 mm ²)		
	3		
	B7 / V-0		



Rated connection	Further connection
1.5...16 / 1.5...25	
1.5...25 / 1.5...16	
2...3.6 Nm (M 5)	
1.2...2.4 Nm (M 4)	
16 / 1.0 x 5.5 mm	

For 25 mm², the TS 35 x 15 (steel, 1.5 mm thick) should be used. Conductor connection H07V...16 and AWG 6 with tightening torque of 2.0-2.4 Nm.

Type	Qty.	Order No.
WPE 16	50	1010400000

Type	Width	Qty.	Order No.
WQB-PEN 16	17.6 mm	10	1060200000
WEW 35/1	12 mm	50	1059000000
SDS 1.0X5.5X150		1	9008350000

DEK 5/5 / WS 12/6,5

Rail holder for protective isolation Installation of the mounting rail "SH 2" Order no. 0494920000 (qty. 10).

WPE 16N

16 mm²

Compact design

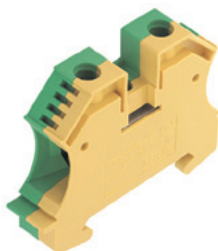

12 x 56 x 47
25
1.5...25

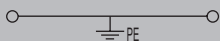

IEC 60947-7-2

IEC	UL	CSA
16	AWG 14...6	AWG 14...6
400		
6		
1920 A (16 mm ²)		
3		
B7 / V-0		



Rated connection	Further connection
1.5...16 / 1.5...25	
1.5...16 / 1.5...16	
1.2...2.4 Nm (M 4)	
0.5...1.0 Nm (M 3)	
12 / 1.0 x 5.5 mm	

25 mm² stranded requires a tightening torque of 2.2 Nm.

Type	Qty.	Order No.
WPE 16N	50	1019100000

Type	Width	Qty.	Order No.
WQV 16N-PEN BL	9 mm	10	1071360000
WEW 35/2	8 mm	100	1061200000
SDS 1.0X5.5X150		1	9008350000

DEK 5/5 / WS 12/6,5

Rail holder for protective isolation Installation of the mounting rail "SH 2" Order no. 0494920000 (qty. 10).

WPE 35

35 mm²

Compact design

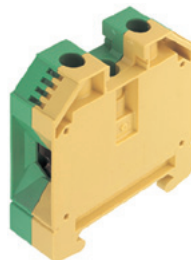

16 x 56 x 63
35
2.5...35



IEC 60947-7-2

Ex e II II 2 G D

IEC	UL	CSA	EN 60079-7
35	AWG 12...2	AWG 12...2	3535
800			
8			
4200 A (35 mm ²)			
3			
B8 / V-0			



Rated connection	Further connection
2.5...16 / 2.5...35	
2.5...35 / 2.5...35	
5 Nm (M 6)	
1.2...2.4 Nm (M 4)	
18 / 6.5 x 1.2 mm	

Type	Qty.	Order No.
WPE 35	25	1010500000

Type	Width	Qty.	Order No.
WQB-PEN 35	24.6 mm	10	1060100000
WEW 35/1	12 mm	50	1059000000
SDS 1.2X6.5X150		1	9009010000

DEK 5/5 / WS 12/6,5

Rail holder for protective isolation Installation of the mounting rail "SH 2" Order no. 0494920000 (qty. 10).

WPE 35N

35 mm²

Compact design

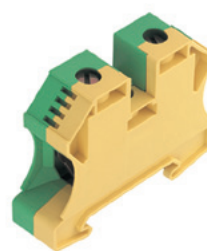

16 x 66 x 51
50
2.5...50

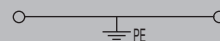

IEC 60947-7-2

IEC	UL	CSA
35		
400		
6		
4200 A (35 mm ²)		
3		
B8 / V-0		

Rated connection	Further connection
2.5...16 / 2.5...50	
2.5...35 / 2.5...35	
1.8...2.4 Nm (M 6)	
1.2...2.4 Nm (M 4)	
18 / 6.5 x 1.2 mm	

Type	Qty.	Order No.
WPE 35N	20	1717740000

Type	Width	Qty.	Order No.
WEW 35/2	8 mm	100	1061200000
SDS 1.2X6.5X150		1	9009010000

DEK 5/5 / WS 12/6,5

Rail holder for protective isolation Installation of the mounting rail "SH 2" Order no. 0494920000 (qty. 10).

PE terminals

Identically contoured design of 2.5 to 10 mm² with identical end plates and partitions. An unmatched combination of many advantages!

The compact terminals are impressive for their small size and rated cross-section capacity.

In hazardous area applications, the installation instructions and the rated data specifications for accessories given in the technical appendix must be followed.

Width/Length/Height of lowest version	mm
max. cond. cross-section	mm ²
Max. clamping range	mm ²

Technical data

Rated data	
Rated cross-section	mm ²
Rated voltage to adjoining terminal	V
Rated impulse withstand voltage to adjacent terminal	kV
Rated short-time current	
Pollution severity	
Gauge to IEC 60947-1 / Flammability class UL94	
Approvals	

Clamped conductors (H05V/H07V)

Solid / stranded	mm ²
Flexible / Flexible with ferrule	mm ²
Tightening torque range (terminal screw)	
Tightening torque range for fixing screw	
Stripping length / Blade size	mm/-

Note

Ordering data

Version	
	green/yellow Wemid
Note	

Accessories

PEN bridge	
End bracket	Dark beige Wemid
Screwdriver	Standard

Identification systems (see assortment in catalogue 7)

Marking tags

Note

WPE 50N

50 mm²

Compact design



18.5 x 71 x 70

70

5.26...70



IEC 60947-7-2

Ex e II



II 2 G D

IEC	UL	CSA	EN 60079-7
50	AWG 10...0	AWG 14...0	5050
1000			
8			
	6000 A (50 mm ²)		
	3		
	B10 / V-0		



Rated connection

Rated connection	Further connection
10...16 / 10...70	
10...50 / 10...50	
4...6 Nm (M 6)	
3.0...4.0 Nm (M 5)	
24 / S4 (DIN 6911)	

For 50 - 120 mm², the TS 35 x 15 (copper, 2.3 mm thick) rail should be used.

Type	Qty.	Order No.
WPE 50N	10	1846040000

Type	Width	Qty.	Order No.
WQV PEN 50N	9.5 mm	5	9201610000
WEW 35/1	12 mm	50	1059000000

DEK 5/5 / WS 12/6,5

Rail holder for protective isolation Installation of the mounting rail "SH 2" Order no. 0494920000 (qty. 10).

WPE 70N/35

70 mm²

Compact design



20.5 x 75 x 86

95

10...95

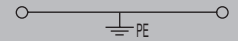

IEC 60947-7-2

Ex e II



II 2 G D

IEC	UL	CSA	EN 60079-7
70	AWG 6...000	AWG 6...000	7070
1000			
8			
	8400 A (70 mm ²)		
	3		
	B11 / V-0		



Rated connection

Rated connection	Further connection
10...16 / 10...95	
10...70 / 10...70	
6...12 Nm (M 8)	
2.0...4.0 Nm (M 5)	
22 / S6 (DIN 6911)	

For 50 - 120 mm², the TS 35 x 15 (copper, 2.3 mm thick) rail should be used.

Type	Qty.	Order No.
WPE 70N/35	10	9512200000

Type	Width	Qty.	Order No.
WQV 70N-PEN	9.5 mm	5	9525840000
WEW 35/1	12 mm	50	1059000000

DEK 5/5 / WS 12/6,5

Rail holder for protective isolation Installation of the mounting rail "SH 2" Order no. 0494920000 (qty. 10).

WPE 95N/120N

95 mm²

Compact design

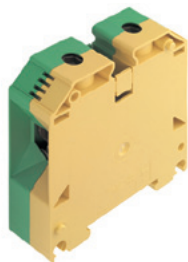

27 x 91 x 91
150
16...150

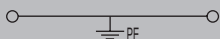

IEC 60947-7-2

Ex e II II 2 G D

IEC	UL	CSA	EN 60079-7
95	AWG 4...000	AWG 4...0000	9595
1000			
8			
	11400 A (95 mm ²)		
	3		
	B13 / V-0		



Rated connection	Further connection
16...16 / 16...150	
16...120 / 16...95	
12...20 Nm M 10	
2.0...4.0 Nm (M 5)	
27 / S6 (DIN 6911)	

For 50 - 120 mm², the TS 35 x 15 (copper, 2.3 mm thick) rail should be used.

Type	Qty.	Order No.
WPE 95N/120N	5	1846030000

UL, CSA and ATEX certifications are pending

Type	Width	Qty.	Order No.
WQV PEN 95N/120N	9.5 mm	5	9201630000
WEW 35/1	12 mm	50	1059000000

WPE 70/95

95 mm²

Conductor can be inserted from above / leaf spring

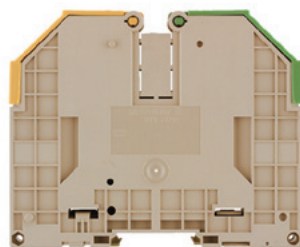

27 x 132 x 115.5
120
13.3...120



IEC 60947-7-2

Ex e II II 2 G D

IEC	UL	CSA	EN 60079-7
95	AWG 6...00	AWG 6...00	9595
1000			
8			
	11400 A (95 mm ²)		
	3		
	B12 / V-0		



Rated connection	Further connection
16...16 / 16...120	
16...95 / 16...95	
6...12 Nm (M 8)	
3.0...6.0 Nm (M 6)	
30 / S6 (DIN 6911)	

For 50 - 120 mm², the TS 35 x 15 (copper, 2.3 mm thick) rail should be used.

Type	Qty.	Order No.
WPE 70/95	10	1037300000

Type	Width	Qty.	Order No.
WQV 70/95-PEN	10 mm	5	1072300000
WEW 35/1	12 mm	50	1059000000

Type	Qty.	Order No.
DEK 5/5 / WS 12/6,5		

Rail holder for protective isolation Installation of the mounting rail "SH 2" Order no. 0494920000 (qty. 10).

WPE 120/150

120 mm²

Conductor can be inserted from above / leaf spring

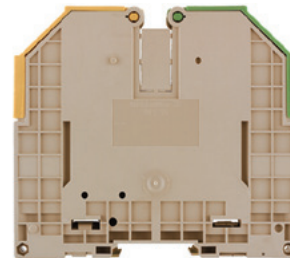

32 x 132 x 125.5
150
33.62...150



IEC 60947-7-2

Ex e II II 2 G D

IEC	UL	CSA	EN 60079-7
120	AWG 2...250	AWG 2...250	120120
1000			
8			
	14400 A (120 mm ²)		
	3		
	B13 / V-0		



Rated connection	Further connection
16...150 / 35...150	
35...150 / 35...95	
10...20 Nm M 10	
3.0...6.0 Nm (M 6)	
35 / S6 (DIN 6911)	

For 50 - 120 mm², the TS 35 x 15 (copper, 2.3 mm thick) rail should be used.

Type	Qty.	Order No.
WPE 120/150	10	1019700000

Type	Width	Qty.	Order No.
WQV 120-PEN	10 mm	5	1072400000
WEW 35/1	12 mm	50	1059000000

Type	Qty.	Order No.
DEK 5/5 / WS 12/6,5		

Rail holder for protective isolation Installation of the mounting rail "SH 2" Order no. 0494920000 (qty. 10).

Fuse terminals

In hazardous area applications, the installation instructions and the rated data specifications for accessories given in the technical appendix must be followed.

Width/Length/Height of lowest version	mm
max. current / max. cond. cross-section	A/mm ²
Max. clamping range	mm ²

Technical data

Rated data	
Rated voltage to adjoining terminal	V
Rated current	A
Rated cross-section	mm ²
Rated impulse withstand voltage / Pollution severity Gauge to IEC 60947-1 / Flammability class UL94	
Approvals	

Clamped conductors (H05V/H07V)

Solid / stranded	mm ²
Flexible / Flexible with ferrule	mm ²
Tightening torque range (terminal screw)	
Stripping length / Blade size	mm/-

2 conductors with same cross-section (H05V/H07V)

Solid / stranded	mm ²
Flexible / Flexible with ferrule	mm ²

Note

Ordering data

Version	
	500 V AC/DC, w/o LED
	10-36 V AC/DC, with LED
	30-70 V AC/DC, with LED
	60-150 V AC/DC, with LED
	140-250 V AC/DC, with LED

Note

Accessories

Screwable cross-connection	
	2-pole
	3-pole
	4-pole
	10-pole

End plate / Partition plate

Dark beige Wemid
Dark beige Wemid

Screwdriver

With "swifty set" cutting device
Standard

End bracket

Dark beige Wemid

G-fuse cartridge, 5 x 20 mm (IEC 60127-2)

0.25 A fast
0.50 A fast
1.00 A fast
2.00 A fast

Identification systems

(see assortment in catalogue 7)

Marking tags

Note

WSI 4/2

4 mm²

WSI 4/2

Overload and short-circuit protection

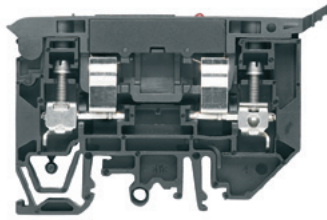

9.1 x 81.6 x 54

6.3 / 4

0.5...4



IEC 60947-7-3

IEC	UL	CSA
500		
6.3		
4	AWG 22...10	AWG 22...10
6 V /		
A3 / V-0		



Rated connection

0.5...4 / 0.5...4
0.5...4 / 0.5...4
0.5...0.8 Nm (M 3)
10 / 0.6 x 3.5 mm

0.5...1.5

0.5...1.5 / 0.5...1.5

Width/length/height with TS 32 = 9.1 x 81.6 x 58.5 mm

Type	Qty.	Order No.
WSI 4/2	25	1880430000
WSI 4/2/LD 10-36V AC/DC	25	1880410000
WSI 4/2/LD 30-70V AC/DC	25	1880440000
WSI 4/2/LD 60-150V AC/DC	25	1880420000
WSI 4/2/LD 140-250V AC/DC	25	1880390000

Type	current	Qty.	Order No.

Width			
WAP WSI4/2	2.5 mm	50	1880450000

SWIFTY SET	18 mm	1	9006060000
SDS 0.6X3.5X100		1	9008330000

DEK 5/5 / WS 12/6

Dummy fuse cartridge, Order no. 1582770000

Type	Order No.
WSI 4/2	1880430000

Arrangement	Applications			
	Only short-circuit protection		Overload and short-circuit protection	
	T_A max.	Nominal values	T_A max.	Nominal values
Individual	55 °C	4.0 W / 10 A	35 °C	2.5 W / 2.5 A
In combination	68 °C	2.5 W / 2.5 A	41 °C	1.6 W / 1.0 A

WSI 4

4 mm²

WSI 4

Overload and short-circuit protection

In hazardous area applications, the installation instructions and the rated data specifications for accessories given in the technical appendix must be followed.

Width/Length/Height of lowest version	mm
max. current / max. cond. cross-section	A/mm ²
Max. clamping range	mm ²

9.1 x 50.7 x 46
6.3 / 6
0.5...6



Technical data

Rated data	
Rated voltage to adjoining terminal	V
Rated current	A
Rated cross-section	mm ²
Rated impulse withstand voltage / Pollution severity Gauge to IEC 60947-1 / Flammability class UL94	
Approvals	
Clamped conductors (H05V/H07V)	
Solid / stranded	mm ²
Flexible / Flexible with ferrule	mm ²
Tightening torque range (terminal screw)	
Stripping length / Blade size	mm/-
2 conductors with same cross-section (H05V/H07V)	
Solid / stranded	mm ²
Flexible / Flexible with ferrule	mm ²
Note	

IEC 60947-7-3

IEC	UL	CSA
500		
6.3		
4	AWG 22...12	AWG 22...12
A3 / V-0		



Rated connection	
0.5...4 / 1.5...4	
0.5...4 / 0.5...2.5	
0.5...0.8 Nm (M 3)	
8 / 0.6 x 3.5 mm	
...4	
0.5...1.5 / 0.5...1.5	

Ordering data

Version	
500 V AC/DC, w/o LED	
10-36 V AC/DC, with LED	
30-70 V AC/DC, with LED	
60-150 V AC/DC, with LED	
140-250 V AC/DC, with LED	
Note	

Type	Qty.	Order No.
WSI 4	50	1886580000
WSI 4/LD 10-36V AC/DC	50	1886590000
WSI 4/LD 30-70V AC/DC	50	1886560000
WSI 4/LD 60-150V AC/DC	50	1886570000
WSI 4/LD 140-250V AC/DC	50	1886550000
Note		

Accessories

Screwable cross-connection	
	2-pole 3-pole 4-pole 10-pole
End plate / Partition plate	
	Dark beige Wemid Dark beige Wemid
Screwdriver	
	With "swifty set" cutting device Standard
End bracket	
	Dark beige Wemid
G-fuse cartridge, 5 x 20 mm (IEC 60127-2)	
	0.25 A fast 0.50 A fast 1.00 A fast 2.00 A fast

Type	current	Qty.	Order No.
Width			
SWIFTY SET	18 mm	1	9006060000
SDS 0.6X3.5X100		1	9008330000
G 20/0.25A/F		10	0430500000
G 20/0.50A/F		10	0430600000
G 20/1.00A/F		10	0430700000
G 20/2.00A/F		10	0430900000

Identification systems	
	(see assortment in catalogue 7) Marking tags
Note	

DEK 5/5 / WS 12/6	
Note	

Type	Order No.			
WSI 4	1886580000			
Arrangement				
Arrangement	Applications			
	Only short-circuit protection		Overload and short-circuit protection	
	T _A max.	Nominal values	T _A max.	Nominal values
Individual	63 °C	4.0 W / 6.3 A	34 °C	1.6 W / 6.3 A
In combination	47 °C	2.5 W / 6.3 A	23 °C	1.6 W / 6.3 A
Note				

Fuse terminals

KDKS 1/35 DB

4 mm²

Metric fuses 5 x 20 mm

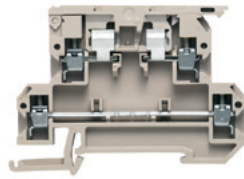

8 x 73.5 x 54.6
6.3 / 4
0.22...4

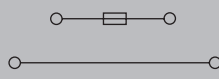

IEC 60947-7-3

IEC	UL	CSA
500	300 (C)	300 (D)
6.3	10 (C)	10 (D)
4	AWG 22...12	
6 kV / 3		
A3 / V-0		



Rated connection	
0.5...4 / 1.5...4	
0.5...4 / 0.5...4	
0.5...0.8 Nm (M 3)	
8 / 0.6 x 3.5 mm	
0.5...1.5	

Note: max. conductor size = 2.5 mm² when using the cross-connector.

KDKS 1/35 DB

Overload and short-circuit protection

Type	Order No.
KDKS 1/35 DB	9532440000

Arrangement	Applications			
	Only short-circuit protection		Overload	
	T _A max.	Nominal values	T _A max.	Nominal values
Individual	23 °C*	4.0 W / 10 A*	41 °C	1.6 W / 6.3 A
In combination	50 °C*	1.6 W / 6.3 A	23 °C	1.6 W / 6.3 A

*) Values not available → The values specified were not measured but instead read from the derating curves and transferred to the "only short-circuit protection" operating mode.

In hazardous area applications, the installation instructions and the rated data specifications for accessories given in the technical appendix must be followed.

Width/Length/Height of lowest version	mm
max. current / max. cond. cross-section	A/mm ²
Max. clamping range	mm ²

Technical data

Rated data	
Rated voltage to adjoining terminal	V
Rated current	A
Rated cross-section	mm ²
Rated impulse withstand voltage / Pollution severity	
Gauge to IEC 60947-1 / Flammability class UL94	
Approvals	

Clamped conductors (H05V/H07V)	
Solid / stranded	mm ²
Flexible / Flexible with ferrule	mm ²
Tightening torque range (terminal screw)	
Stripping length / Blade size	

2 conductors with same cross-section (H05V/H07V)	
Solid / stranded	mm ²
Flexible / Flexible with ferrule	mm ²

Note

Ordering data

Version	
	500 V AC/DC, w/o LED
	10-36 V AC/DC, with LED
	30-70 V AC/DC, with LED
	60-150 V AC/DC, with LED
	140-250 V AC/DC, with LED

Note

Type	Qty.	Order No.
KDKS 1/35 DB	50	9532440000

Max. power loss (1.6 W) at the cartridge fuse limits the rated current.

Accessories

Screwable cross-connection	
	2-pole
	3-pole
	4-pole
	10-pole

End plate / Partition plate	
	Dark beige Wemid
	Dark beige Wemid

Screwdriver	
	With "swifty set" cutting device
	Standard

End bracket	
	Dark beige Wemid

G-fuse cartridge, 5 x 20 mm (IEC 60127-2)	
0.25 A fast	
0.50 A fast	
1.00 A fast	
2.00 A fast	

Type	current	Qty.	Order No.

Width			
AP KDKS1 DB	1.5 mm	20	9532470000

G 20/0.25A/F	10	0430500000
G 20/0.50A/F	10	0430600000
G 20/1.00A/F	10	0430700000
G 20/2.00A/F	10	0430900000

Identification systems	
	(see assortment in catalogue 7)
	Marking tags

Note

DEK 5/8

WSI 6 **6 mm²**

Metric fuses

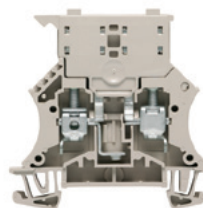

7.9 x 60 x 62
6.3 / 10
0.5...10

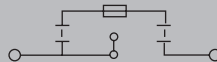

IEC 60947-7-3

IEC	UL	CSA
500	600 (C)	600 (C)
6.3	9.5 (C)	10 (C)
6	AWG 20...8	AWG 20...8
6 kV / 3		
A5 / V-0		



Rated connection	
0.5...10 / 1.5...10	
0.5...10 / 0.5...6	
0.8...1.6 Nm (M 3.5)	
12 / 4.0 x 0.8 mm	
2 conductors with same cross-section (H05V/H07V)	
Solid / stranded	mm ²
Flexible / Flexible with ferrule	mm ²
Note	

In hazardous area applications, the installation instructions and the rated data specifications for accessories given in the technical appendix must be followed.

Width/Length/Height of lowest version	mm
max. current / max. cond. cross-section	A/mm ²
Max. clamping range	mm ²

Technical data

Rated data	
Rated voltage to adjoining terminal	V
Rated current	A
Rated cross-section	mm ²
Rated impulse withstand voltage / Pollution severity	
Gauge to IEC 60947-1 / Flammability class UL94	
Approvals	
Clamped conductors (H05V/H07V)	
Solid / stranded	mm ²
Flexible / Flexible with ferrule	mm ²
Tightening torque range (terminal screw)	
Stripping length / Blade size	mm/-
2 conductors with same cross-section (H05V/H07V)	
Solid / stranded	mm ²
Flexible / Flexible with ferrule	mm ²
Note	

Ordering data

Version	
500 V AC/DC, w/o LED	
10-36 V AC/DC, with LED	
30-70 V AC/DC, with LED	
60-150 V AC/DC, with LED	
140-250 V AC/DC, with LED	
Note	

Type	Qty.	Order No.
WSI 6	50	1011000000
Max. power loss (1.6 W) at the cartridge fuse limits the rated current.		

Accessories

Screwable cross-connection	
	2-pole
	3-pole
	4-pole
	10-pole
End plate / Partition plate	
	Dark beige Wemid
	Dark beige Wemid
Screwdriver	
	With "swifty set" cutting device
	Standard
End bracket	
	Dark beige Wemid
G-fuse cartridge, 5 x 20 mm (IEC 60127-2)	
	0.25 A fast
	0.50 A fast
	1.00 A fast
	2.00 A fast

Type	current	Qty.	Order No.
QL 2 SAK6N	32 A	50	0194300000
QL 3 SAK6N	57 A	50	0194400000
QL 4 SAK6N	57 A	50	0194500000
QL 10 SAK6N	32 A	20	0338300000
Width			
WAP 2.5-10	1.5 mm	50	1050000000
WAP 16*35 WTW 2.5-10	1.5 mm	20	1050100000
SDS 0.8X4.0X100		1	9008340000
WEW 35/2	8 mm	100	1061200000
G 20/0.25A/F		10	0430500000
G 20/0.50A/F		10	0430600000
G 20/1.00A/F		10	0430700000
G 20/2.00A/F		10	0430900000

Identification systems	
	(see assortment in catalogue 7)
	Marking tags
Note	

DEK 5/8 / WS 12/6,5
Screw M 3x5 Order no. 1052100000 for QL 2 - QL 10.

WSI 6

Overload and short-circuit protection

Type	Order No.
WSI 6	1011000000

Arrangement	Applications			
	Only short-circuit protection		Overload and short-circuit protection	
	T _A max.	Nominal values	T _A max.	Nominal values
Individual			31 °C	1.6 W / 3.0 A
In combination			27 °C	1.6 W / 3.0 A

Fuse terminals

WSI 6 LD

6 mm²

Metric fuses / bipolar LED

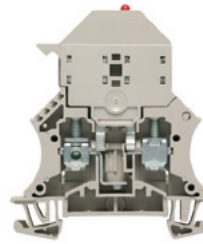

In hazardous area applications, the installation instructions and the rated data specifications for accessories given in the technical appendix must be followed.

Width/Length/Height of lowest version	mm
max. current / max. cond. cross-section	A/mm ²
Max. clamping range	mm ²

7.9 x 60 x 72
6.3 / 10
0.5...10

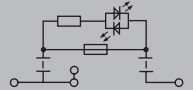

Technical data

Rated data	
Rated voltage to adjoining terminal	V
Rated current	A
Rated cross-section	mm ²
Rated impulse withstand voltage / Pollution severity	
Gauge to IEC 60947-1 / Flammability class UL94	
Approvals	

Clamped conductors (H05V/H07V)

Solid / stranded	mm ²
Flexible / Flexible with ferrule	mm ²
Tightening torque range (terminal screw)	
Stripping length / Blade size	mm/-

2 conductors with same cross-section (H05V/H07V)

Solid / stranded	mm ²
Flexible / Flexible with ferrule	mm ²

Note

IEC 60947-7-3

IEC	UL	CSA
6.3		
6	AWG 20...8	AWG 20...8
	6 kV / 3	
	A5 / V-0	



Rated connection

0.5...10 / 1.5...10
0.5...10 / 0.5...6
0.8...1.6 Nm (M 3.5)
12 / 4.0 x 0.8 mm

0.5...2.5
0.5...2.5 / 0.5...2.5

Ordering data

Version	
	500 V AC/DC, w/o LED
	10-36 V AC/DC, with LED
	30-70 V AC/DC, with LED
	60-150 V AC/DC, with LED
	140-250 V AC/DC, with LED

Note

Type	Qty.	Order No.
WSI 6/LD 10-36V DC/AC	50	1011300000
WSI 6/LD 30-70V DC/AC	50	1012200000
WSI 6/LD 60-150V DC/AC	50	1012300000
WSI 6/LD 250AC	50	1012400000

Max. power loss (1.6 W) at the cartridge fuse limits the rated current.

Accessories

Screwable cross-connection	
	2-pole
	3-pole
	4-pole
	10-pole

End plate / Partition plate

Dark beige Wemid
 Dark beige Wemid

Screwdriver

With "swifty set" cutting device
 Standard

End bracket

Dark beige Wemid

G-fuse cartridge, 5 x 20 mm (IEC 60127-2)

0.25 A fast
 0.50 A fast
 1.00 A fast
 2.00 A fast

Type	current	Qty.	Order No.
QL 2 SAK6N	32 A	50	0194300000
QL 3 SAK6N	57 A	50	0194400000
QL 4 SAK6N	57 A	50	0194500000
QL 10 SAK6N	32 A	20	0338300000

Width			
WAP 2.5-10	1.5 mm	50	1050000000
WAP 16+35 WTW 2.5-10	1.5 mm	20	1050100000

SDS 0.8X4.0X100	1	9008340000
-----------------	---	------------

WEW 35/2	8 mm	100	1061200000
----------	------	-----	------------

G 20/0.25A/F	10	0430500000
--------------	----	------------

G 20/0.50A/F	10	0430600000
--------------	----	------------

G 20/1.00A/F	10	0430700000
--------------	----	------------

G 20/2.00A/F	10	0430900000
--------------	----	------------

Identification systems (see assortment in catalogue 7)

Marking tags

Note

DEK 5/8 / WS 12/6,5

Screw M 3x5 Order no. 1052100000 for QL 2 - QL 10.

WSI 6/2

6 mm²

Imperial fuses

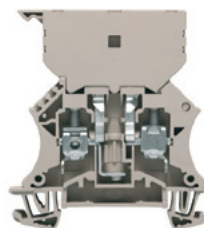

11.9 x 60 x 67
6.3 / 10
0.5...10

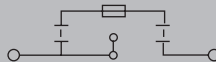

IEC 60947-7-3

IEC	UL	CSA
500	600 (C)	150 (C)
6.3	16 (C)	16 (C)
6	AWG 22...8	AWG 20...6
6 kV / 3		
A5 / V-0		



Rated connection
0.5...10 / 1.5...10
0.5...10 / 0.5...6
0.8...1.6 Nm (M 3.5)
12 / 4.0 x 0.8 mm
0.5...2.5
0.5...2.5 / 0.5...2.5

Fuse inserts or contact sleeves should be attached in the middle.

WSI 6/2

Overload and short-circuit protection

Type	Order No.
WSI 6/2 GZ/DEF63	1014000000

Arrangement	Applications			
	Only short-circuit protection		Overload and short-circuit protection	
	T _A max.	Nominal values	T _A max.	Nominal values
Individual	52 °C	4.0 W / 10.0 A	42 °C	2.5 W / 2.5 A
In combination	62 °C	2.5 W / 2.5 A	30 °C	2.5 W / 2.5 A

In hazardous area applications, the installation instructions and the rated data specifications for accessories given in the technical appendix must be followed.

Width/Length/Height of lowest version	mm
max. current / max. cond. cross-section	A/mm ²
Max. clamping range	mm ²

Technical data

Rated data	
Rated voltage to adjoining terminal	V
Rated current	A
Rated cross-section	mm ²
Rated impulse withstand voltage / Pollution severity	
Gauge to IEC 60947-1 / Flammability class UL94	
Approvals	
Clamped conductors (H05V/H07V)	
Solid / stranded	mm ²
Flexible / Flexible with ferrule	mm ²
Tightening torque range (terminal screw)	
Stripping length / Blade size	mm/-
2 conductors with same cross-section (H05V/H07V)	
Solid / stranded	mm ²
Flexible / Flexible with ferrule	mm ²

Note

Ordering data

Version
500 V AC/DC, w/o LED
10-36 V AC/DC, with LED
30-70 V AC/DC, with LED
60-150 V AC/DC, with LED
140-250 V AC/DC, with LED

Note

Type	Qty.	Order No.
WSI 6/2 GZ/DEF63	25	1014000000

Max. power loss (1.6 W) at the cartridge fuse limits the rated current.

Accessories

Screwable cross-connection	
	2-pole
	3-pole
	4-pole
	10-pole
	Lock washer
	Mounting screw
End plate / Partition plate	
	Dark beige Wemid
	Dark beige Wemid
G25 with indicator / imperial (inch) fuse	
	0.50 A medium slow / 2 A
	1.00 A medium slow / 3 A
	2.00 A fast / 5 A
	4.00 A fast / 10 A



Type	current	Qty.	Order No.
QL 2 SAK16	76 A	50	0470700000
QL 3 SAK16	76 A	50	0470800000
QL 4 SAK16	76 A	50	0470900000
QL 10 SAK16	76 A	20	0471000000
SS M3 D 128-A 3		50	0164400000
KISC M3X5		100	1052100000
Width			
WAP 2.5-10	1.5 mm	50	1050000000
WAP 16*35 WTW 2.5-10	1.5 mm	20	1050100000
GZ 2.0A		10	0294500000
GZ 3.0A		10	0295700000
GZ 5.0A		10	0294600000
GZ 10.0A		10	0293900000

Identification systems (see assortment in catalogue 7)
Marking tags

Note

DEK 5/8 / WS 12/6,5
Refer to the W-Series accessories section for cross-connection information.

Fuse terminals

In hazardous area applications, the installation instructions and the rated data specifications for accessories given in the technical appendix must be followed.

Width/Length/Height of lowest version	mm
max. current / max. cond. cross-section	A/mm ²
Max. clamping range	mm ²

Technical data

Rated data	
Rated voltage to adjoining terminal	V
Rated current	A
Rated cross-section	mm ²
Rated impulse withstand voltage / Pollution severity	
Gauge to IEC 60947-1 / Flammability class UL94	
Approvals	
Clamped conductors (H05V/H07V)	
Solid / stranded	mm ²
Flexible / Flexible with ferrule	mm ²
Tightening torque range (terminal screw)	
Stripping length / Blade size	mm/-
2 conductors with same cross-section (H05V/H07V)	
Solid / stranded	mm ²
Flexible / Flexible with ferrule	mm ²
Note	

Ordering data

Version	
	500 V AC/DC, w/o LED
	10-36 V AC/DC, with LED
	30-70 V AC/DC, with LED
	60-150 V AC/DC, with LED
	140-250 V AC/DC, with LED
Note	

Accessories

Screwable cross-connection	
	2-pole
	3-pole
	4-pole
	10-pole
	Lock washer
	Mounting screw
End plate / Partition plate	
	Dark beige Wemid
	Dark beige Wemid
G25 with indicator / imperial (inch) fuse	
	0.50 A medium slow / 2 A
	1.00 A medium slow / 3 A
	2.00 A fast / 5 A
	4.00 A fast / 10 A

Identification systems	(see assortment in catalogue 7)
	Marking tags
Note	

WSI 6/2 m. LED

6 mm²

Imperial fuses / bipolar LED

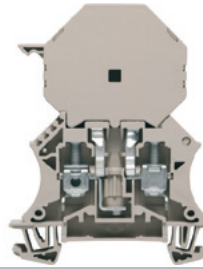

11.9 x 60 x 79.5
6.3 / 10
0.5...10

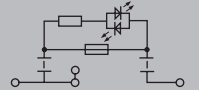

IEC 60947-7-3

IEC	UL	CSA
6.3		
6	AWG 22...8	AWG 20...6
6 kV / 3		
A5 / V-0		
Rated connection		
0.5...10 / 1.5...10		
0.5...10 / 0.5...6		
0.8...1.6 Nm (M 3.5)		
12 / 4.0 x 0.8 mm		
0.5...2.5		
0.5...2.5 / 0.5...2.5		
Fuse inserts or contact sleeves should be attached in the middle.		

Type	Qty.	Order No.
WSI 6/2/LD 10-36V DC/AC	25	1014100000
WSI 6/2/LD 30-70V DC/AC	25	1014200000
WSI 6/2/LD 60-150VDC/AC	25	1014300000
WSI 6/2/LD 250AC	25	1014400000
Max. power loss (1.6 W) at the cartridge fuse limits the rated current.		

Type	current	Qty.	Order No.
QL 2 SAK16	76 A	50	0470700000
QL 3 SAK16	76 A	50	0470800000
QL 4 SAK16	76 A	50	0470900000
QL 10 SAK16	76 A	20	0471000000
SS M3 D 128-A 3		50	0164400000
KISC M3X5		100	1052100000
Width			
WAP 2.5-10	1.5 mm	50	1050000000
WAP 16*35 WTW 2.5-10	1.5 mm	20	1050100000
GZ 2.0A		10	0294500000
GZ 3.0A		10	0295700000
GZ 5.0A		10	0294600000
GZ 10.0A		10	0293900000

DEK 5/8 / WS 12/6,5
Refer to the W-Series accessories section for cross-connection information.

WSI 6 LD LLC fused terminal blocks with minimised leakage current

Clearly visible status LED with extremely low leakage current for error indication with an optimal energy balance

Weidmüller has extended its line of screw connect fuse terminals to include the WSI 6 LD LLC and WSI 6/2 LD LLC variants. The terminals have bright status displays which are wired in parallel with the fuse so that, in the event of an outage, the fuse supplies a low leakage current to the LEDs. Since this is undesired current, it is maintained at the lowest level possible. Weidmüller's BFI (Blown Fuse Indicator) circuitry is designed for a reduced leakage current of less than 500 μA . Despite the reduced leakage current, the status displays are still very bright and thus always easy to see.

The leakage current of the bipolar LED circuitry complies with the CSA standard C22.2 No. 39 for fuse holder units and the UL standard 512 for fuse holders.

Fuse is convenient to replace

The fuse holder is easy to access and can pivot, so you can quickly and safely replace a blown fuse.

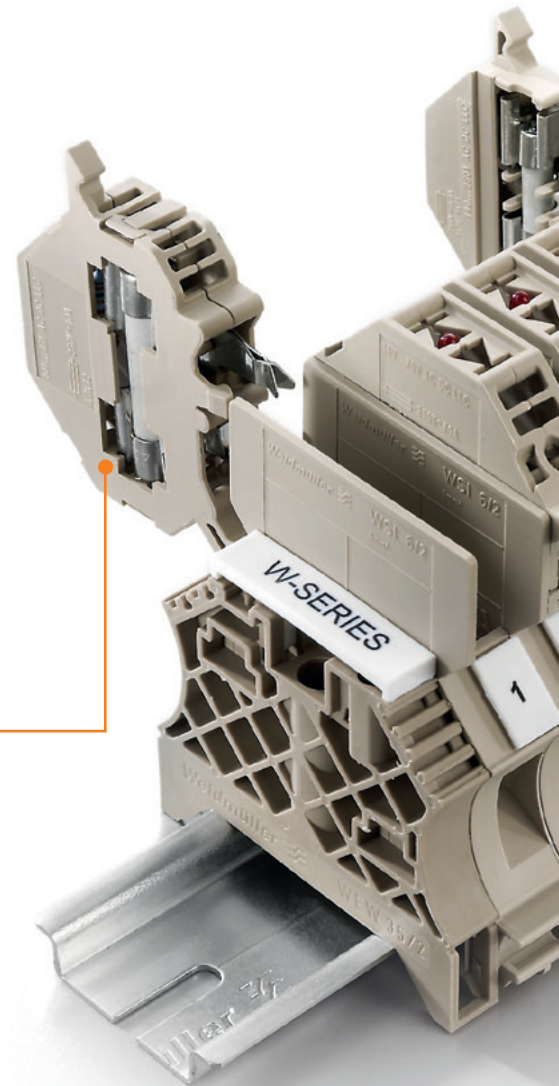
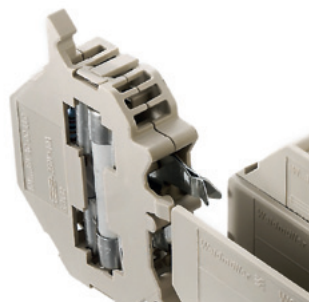

Good cable visibility

Because of the broad width, visibility remains clear and accessible even with many wires connected.

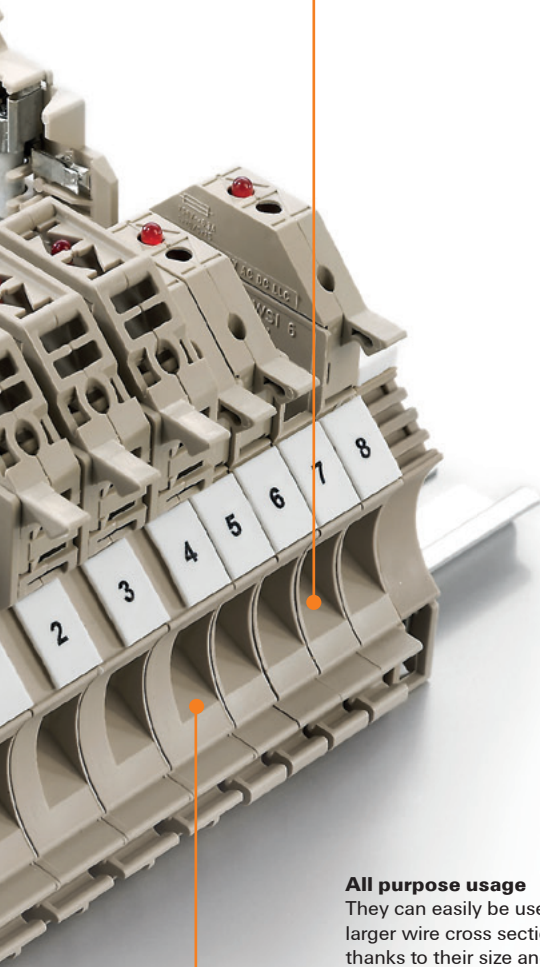

All purpose usage

They can easily be used in applications with larger wire cross sections of up to 10 mm², thanks to their size and the use of larger connection elements.



WSI 6 LD LLC

The WSI-6-LD-LLC variants, with their thin 7.9 mm width, are perfect for use with the 5 x 20 mm fuses.

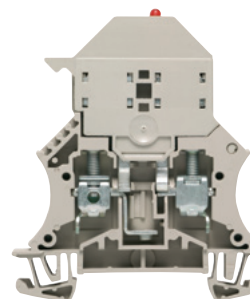

WSI 6/2 LD LLC

The WSI-6/2-LD-LLC variants, with their width of 11.9 mm, are the best solution for use with 1 1/4" x 1/4" fuses.

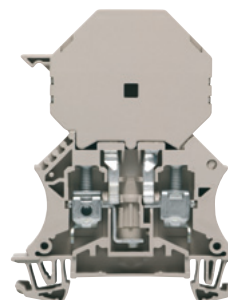

Fuse terminals

WSI 6/LD LLC

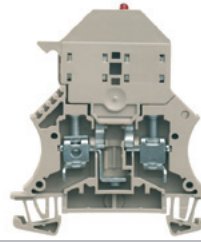
6 mm²

In hazardous area applications, the installation instructions and the rated data specifications for accessories given in the technical appendix must be followed.

Width/Length/Height of lowest version	mm
max. current / max. cond. cross-section	A/mm ²
Max. clamping range	mm ²

7.9 x 60 x 72
6.3 / 10
0.5...10

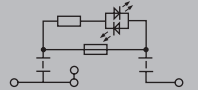

Technical data

Rated data	
Rated voltage to adjoining terminal	V
Rated current	A
Rated cross-section	mm ²
Rated impulse withstand voltage / Pollution severity	
Gauge to IEC 60947-1 / Flammability class UL94	
Approvals	

Clamped conductors (H05V/H07V)

Solid / stranded	mm ²
Flexible / Flexible with ferrule	mm ²
Tightening torque range (terminal screw)	
Stripping length / Blade size	mm/-

2 conductors with same cross-section (H05V/H07V)

Solid / stranded	mm ²
Flexible / Flexible with ferrule	mm ²

Note

IEC 60947-7-3

IEC	UL	CSA
500	600 (C)	250 (C)
6.3	10 (C)	6.3 (C)
6	AWG 22...8	AWG 20...8
/ 3		
A5 / V-0		



Rated connection

0.5...10 / 1.5...10
0.5...10 / 0.5...6
0.8...1.6 Nm (M 3.5)
/ 4.0 x 0.8 mm

0.5...2.5 / 0.5...2.5

Ordering data

Version	
	10-36 V AC/DC, with LED
	30-70 V AC/DC, with LED
	60-150 V AC/DC, with LED
	140-250 V AC/DC, with LED

Note

Type	Qty.	Order No.
WSI 6/LD 10-36V LLC	50	1119840000
WSI 6/LD 30-70V LLC	50	1119830000
WSI 6/LD 60-150V LLC	50	1119850000
WSI 6/LD 250AC LLC	50	1119870000

Accessories

Screwable cross-connection



2-pole
 3-pole
 4-pole
 10-pole

End plate / Partition plate

Dark beige Wemid
 Dark beige Wemid

End bracket

Dark beige Wemid

G-fuse cartridge, 5 x 20 mm (IEC 60127-2)

0.25 A fast
 0.50 A fast
 1.00 A fast
 2.00 A fast

Screwdriver

Standard

Type	current	Qty.	Order No.
QL 2 SAK6N	32 A	50	0194300000
QL 3 SAK6N	57 A	50	0194400000
QL 4 SAK6N	57 A	50	0194500000
QL 10 SAK6N	32 A	20	0338300000

Width

WAP 2.5-10	1.5 mm	50	1050000000
WAP 16+35 WTW 2.5-10	1.5 mm	20	1050100000
WEW 35/2	8 mm	100	1061200000
G 20/0.25A/F		10	0430500000
G 20/0.50A/F		10	0430600000
G 20/1.00A/F		10	0430700000
G 20/2.00A/F		10	0430900000
SDS 0.8X4.0X100		1	9008340000

Identification systems (see assortment in catalogue 7)

Marking tags

Note

DEK 5/8 / WS 12/6,5

WSI 6/2/LD LLC

6 mm²

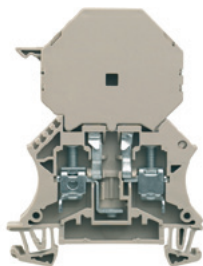

In hazardous area applications, the installation instructions and the rated data specifications for accessories given in the technical appendix must be followed.

Width/Length/Height of lowest version	mm
max. current / max. cond. cross-section	A/mm ²
Max. clamping range	mm ²

11.9 x 60 x 79.5
6.3 / 10
0.5...10

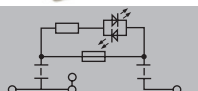

Technical data

Rated data	
Rated voltage to adjoining terminal	V
Rated current	A
Rated cross-section	mm ²
Rated impulse withstand voltage / Pollution severity	
Gauge to IEC 60947-1 / Flammability class UL94	
Approvals	

IEC 60947-7-3

IEC	UL	CSA
500	600 (C)	150 (C)
6.3	10 (C)	6.3 (C)
6	AWG 22...8	AWG 20...8
/ 3		
A5 / V-0		

Clamped conductors (H05V/H07V)

Solid / stranded	mm ²
Flexible / Flexible with ferrule	mm ²
Tightening torque range (terminal screw)	
Stripping length / Blade size	mm/-



Rated connection

0.5...10 / 1.5...10
0.5...10 / 0.5...6
0.8...1.6 Nm (M 3.5)
/ 4.0 x 0.8 mm

2 conductors with same cross-section (H05V/H07V)

Solid / stranded	mm ²
Flexible / Flexible with ferrule	mm ²

0.5...2.5 / 0.5...2.5

Note

Ordering data

Version	
	10-36 V AC/DC, with LED
	30-70 V AC/DC, with LED
	60-150 V AC/DC, with LED
	140-250 V AC/DC, with LED

Note

Type	Qty.	Order No.
WSI 6/2/LD 10-36V LLC	25	1119800000
WSI 6/2/LD 30-70V LLC	25	1119810000
WSI 6/2/LD 60-150V LLC	25	1119820000
WSI 6/2/LD 250AC LLC	25	1119790000

Accessories

Screwable cross-connection	
	2-pole
	3-pole
	4-pole
	10-pole

End plate / Partition plate	
	Dark beige Wemid
	Dark beige Wemid

End bracket	
	Dark beige Wemid

G25 with indicator / imperial (inch) fuse	
	0.50 A medium slow / 2 A
	1.00 A medium slow / 3 A
	2.00 A fast / 5 A
	4.00 A fast / 10 A

Screwdriver	
	Standard

Type	current	Qty.	Order No.
QL 2 SAK16	76 A	50	0470700000
QL 3 SAK16	76 A	50	0470800000
QL 4 SAK16	76 A	50	0470900000
QL 10 SAK16	76 A	20	0471000000

Width			
WAP 2.5-10	1.5 mm	50	1050000000
WAP 16+35 WTW 2.5-10	1.5 mm	20	1050100000
WEW 35/2	8 mm	100	1061200000
GZ 2.0A		10	0294500000
GZ 3.0A		10	0295700000
GZ 5.0A		10	0294600000
GZ 10.0A		10	0293900000
SDS 0.8X4.0X100		1	9008340000

Identification systems	(see assortment in catalogue 7)
	Marking tags

DEK 5/8 / WS 12/6,5

Note

Cross-connections with test-disconnect terminal / fuse terminal WSI 6

WSI 6 installation

To install, screw the cross-connection lugs QL X SAK6N directly to the current bar (Order No. 1052 100000 KISC M3X5). To do this, push out the pre-punched side window of the terminal carrier with the help of tool WAW 2 (order No. 90045 10000) and clip the terminal in place. Now open the fuse holder and insert the fixing screw. Slip the cross-connection lug in through the punched opening in the side of the terminal carrier and secure it with the fixing screw.

Important! The side window of the last terminal may not be broken out as otherwise the rated voltage cannot be guaranteed.

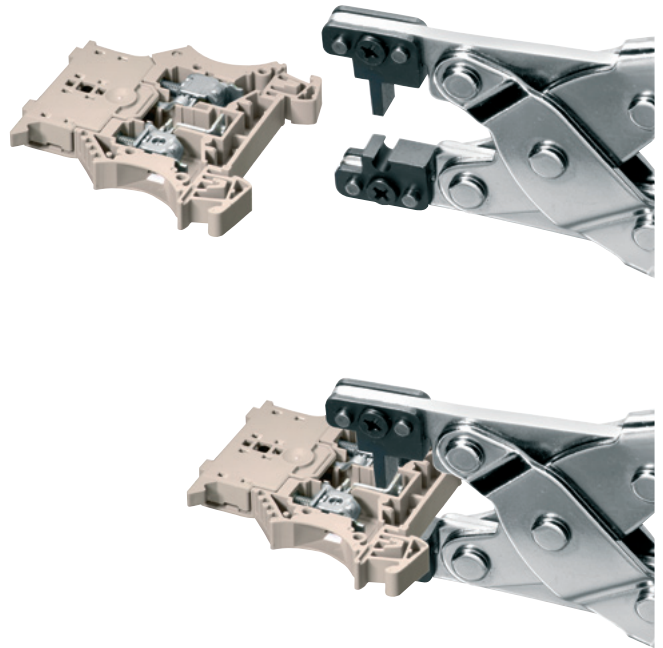

Fuse terminals

In hazardous area applications, the installation instructions and the rated data specifications for accessories given in the technical appendix must be followed.

Width/Length/Height of lowest version	mm
max. current / max. cond. cross-section	A
Max. clamping range	mm ²

Technical data

Rated data	
Rated voltage to adjoining terminal	V
Rated current	A
Rated cross-section	mm ²
Rated impulse withstand voltage / Pollution severity	
Gauge to IEC 60947-1 / Flammability class UL94	
Approvals	
Clamped conductors (H05V/H07V)	
Solid / stranded	mm ²
Flexible / Flexible with ferrule	mm ²
Tightening torque range (terminal screw)	
Stripping length / Blade size	mm/-
Note	

Ordering data

Version	
1-pole, without LED	
2-pole, without LED	
3-pole, without LED	
1-pole, with LED	
Note	

Accessories

Type	Width	Qty.	Order No.
------	-------	------	-----------

Identification systems	
(see assortment in catalogue 7)	
Marking tags	
Note	

Technical drawing

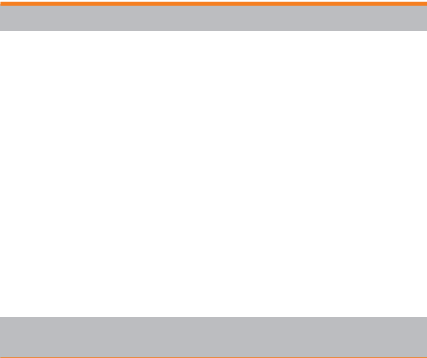

WSI 25 10x38

25 mm²



36 x 58 x 58
32 / 25
1.5...25

IEC 60947-7-3		
IEC	UL	CSA
690		600 (C)
32		30 (C)
25		AWG 14...3
6 kV / 3 / V-0		
Rated connection		
1.5...25 / 1.5...25		
1.5...25 / 1.5...25		
2...2.5 Nm		
Suitable for fuse cartridges to IEC 60269-6 with power loss up to 3 W maximum.		

Type	Qty.	Order No.
WSI 25/1 10x38	12	1966020000
WSI 25/2 10x38	6	1966090000
WSI 25/3 10x38	4	1966080000
WSI 25/1 10x38/LED	12	1966060000

WSI 25 CC

25 mm²



18 x 58 x 58
32 / 25
1.5...25

IEC 60947-7-3		
IEC	UL	CSA
690		
32		
25		AWG 18...4
6 kV / 3 / V-0		
Rated connection		
1.5...25 / 1.5...25		
1.5...25 / 1.5...25		
2...2.5 Nm		
Suitable for fuse cartridges to IEC 60269-6 with power loss up to 3 W maximum.		

Type	Qty.	Order No.
WSI 25/1 CC	12	1966050000
WSI 25/2 CC	6	1966040000
WSI 25/3 CC	4	1966030000
WSI 25/1 CC/LED	12	1966070000

Type	Width	Qty.	Order No.
------	-------	------	-----------

Identification systems	
(see assortment in catalogue 7)	
Marking tags	
Note	

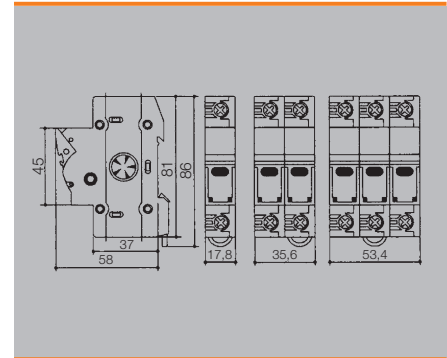

WSI 25/1 10x38 1KV

25 mm²

NEW



In hazardous area applications, the installation instructions and the rated data specifications for accessories given in the technical appendix must be followed.

Width/Length/Height of lowest version	mm
max. current / max. cond. cross-section	A/mm ²
Max. clamping range	mm ²

18 x 58 x 58
32 / 25
1.5...25

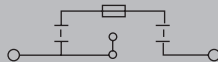

Technical data

Rated data	
Rated voltage to adjoining terminal	V
Rated current	A
Rated cross-section	mm ²
Rated impulse withstand voltage / Pollution severity	
Gauge to IEC 60947-1 / Flammability class UL94	
Approvals	
Clamped conductors (H05V/H07V)	
Solid / stranded	mm ²
Flexible / Flexible with ferrule	mm ²
Tightening torque range (terminal screw)	
Stripping length / Blade size	mm/-

IEC 60947-7-3

IEC	UL	CSA
1000		
32		
25		
	6 kV / 3	
	/ V-0	

Note

Rated connection	
1.5...25 / 1.5...25	
1.5...25 / 1.5...25	
2...2.5 Nm	

Suitable for fuse cartridges to IEC 60269-6 with power loss up to 3 W maximum.

Ordering data

Version	
1-pole, without LED	
1-pole, with LED	

Note

Type	Qty.	Order No.
WSI 25/1 10x38 1KV	12	1137790000
WSI 25/1 10X38/LED 1KV	12	1137780000

Accessories

Safety fuses	
2 A	
4 A	
6 A	
8 A	
10 A	
12 A	
16 A	
20 A	

Type	Width	Qty.	Order No.
FUSE 1KV DC 2A 10/38		10	1224870000
FUSE 1KV DC 4A 10/38		10	1224880000
FUSE 1KV DC 6A 10/38		10	1224890000
FUSE 1KV DC 8A 10/38		10	1224900000
FUSE 1KV DC 10A 10/38		10	1224910000
FUSE 1KV DC 12A 10/38		10	1224920000
FUSE 1KV DC 16A 10/38		10	1224930000
FUSE 1KV DC 20A 10/38		10	1224950000

(see assortment in catalogue 7)

Note

Fuse terminals

In hazardous area applications, the installation instructions and the rated data specifications for accessories given in the technical appendix must be followed.

Width/Length/Height of lowest version	mm
max. current / max. cond. cross-section	A/mm ²
Max. clamping range	mm ²

Technical data

Rated data	
Rated voltage to adjoining terminal	V
Rated current	A
Rated cross-section	mm ²
Rated impulse withstand voltage / Pollution severity	
Gauge to IEC 60947-1 / Flammability class UL94	
Approvals	
Clamped conductors (H05V/H07V)	
Solid / stranded	mm ²
Flexible / Flexible with ferrule	mm ²
Tightening torque range (terminal screw)	
Stripping length / Blade size	mm/-
Note	

Ordering data

Version	500 V AC/DC, w/o LED
Note	

Accessories

Screwable cross-connection	
	2-pole
	3-pole
	4-pole
	10-pole
	Lock washer
	Mounting screw
End plate / Partition plate	
	Dark beige Wemid
Screw cover cap	
	SK
Fuse cartridges	
Gauge rings	

Identification systems	(see assortment in catalogue 7)
	Marking tags
Note	

SAKS 2/35 DB

10 mm²

D fuses E 16

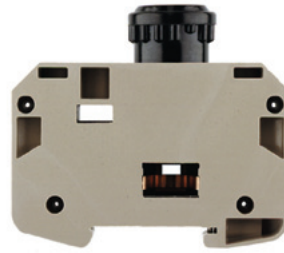

27.6 x 80 x 75	
10 / 16	
0.22...16	

IEC 60947-7-3

IEC	UL	CSA
500		600 (C)
10		25 (C)
10		AWG 22...8
	6 kV / 3	
	B6 / V-0	
Rated connection		
0.5...16 / 0.5...10		
0.5...10 / 0.5...10		
1.2...2.4 Nm (M 4)		
12 / 1.0 x 5.5 mm		
Connections for stranded conductors from 10 mm ² and AWG conductors require a tightening torque of 2 Nm.		

Type	Qty.	Order No.
SAKS 2/35 DB	20	1368700000
Material Duroplast KRG		

Type	current	Qty.	Order No.
QL 2 SAKS2	36 A	20	0207800000
QL 4 SAKS2	36 A	20	0208000000
QL 10 SAKS2	36 A	20	0338900000
SS M4 D 128-A 4		100	0136400000
BFSC M4X9T		100	0103300000
Width			
WTW EN	3 mm	20	1058800000
SK E16/SAKS2		25	0284110000
E 16/10A RT TNDZ		25	0208500000
E 16/16A GR TNDZ		25	0208600000
E 16/20A BL TNDZ		25	0208700000
E 16/25A GE TNDZ		25	0208800000
P 16/10 RT SAKS2		100	0208900000
P 16/16 GR SAKS2		100	0209000000
P 16/20 BL SAKS2		100	0209100000

Identification systems	(see assortment in catalogue 7)
	Marking tags
Note	

DEK 5/5	Replacement screw cover cap, Order no. 0284110000 (qty. 20).
---------	--

SAKS 4/35 DB

10 mm²

D 01 fuses E 14



24 x 75 x 66	
16 / 16	
0.22...16	

IEC 60947-7-3

IEC	UL	CSA
400	600 (C)	600 (C)
16	30 (C)	30 (C)
10	AWG 22...8	AWG 22...8
	6 kV / 3	
	B6 / V-0	
Rated connection		
0.5...16 / 0.5...10		
0.5...10 / 0.5...10		
1.2...2.4 Nm (M 4)		
14 / 1.0 x 5.5 mm		
400 V also available with Neozed shipbuilding fuse. When connecting wires of 10 mm ² or larger, the torque for stranded and 7-core AWG wires is 2 Nm.		

Type	Qty.	Order No.
SAKS 4/35 DB	20	0501800000
Material Duroplast KRG		

Type	current	Qty.	Order No.
QL 2 SAKS4	36 A	20	0328000000
QL 3 SAKS4	36 A	20	0328100000
QL 10 SAKS4	36 A	20	0339000000
SS M4 D 128-A 4		100	0136400000
BFSC M4X9T		100	0103300000
Width			
WTW EN	3 mm	20	1058800000
SK E14 SAKS4		20	0339410000
E 14/2A RS		10	0137400000
E 14/4A BR		10	0137500000
E 14/6A GN		10	0328300000
E 14/10A RT		10	0328400000
P 14/2 D01 RS SAKS4		50	0138000000
P 14/4 D01 BR SAKS4		50	0138100000

Identification systems	(see assortment in catalogue 7)
	Marking tags
Note	

DEK 5/5	Replacement screw cover cap, Order no. 0339410000 (qty. 20).
---------	--

SAKS 5/35 DB

10 mm²

D 02 fuse E 18

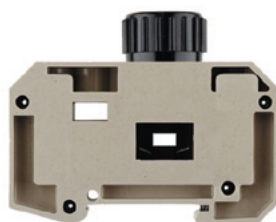

In hazardous area applications, the installation instructions and the rated data specifications for accessories given in the technical appendix must be followed.

Width/Length/Height of lowest version	mm
max. current / max. cond. cross-section	A/mm ²
Max. clamping range	mm ²

28 x 80 x 66
63 / 16
1.5...16

Technical data

Rated data	
Rated voltage to adjoining terminal	V
Rated current	A
Rated cross-section	mm ²
Rated impulse withstand voltage / Pollution severity	
Gauge to IEC 60947-1 / Flammability class UL94	
Approvals	
Clamped conductors (H05V/H07V)	
Solid / stranded	mm ²
Flexible / Flexible with ferrule	mm ²
Tightening torque range (terminal screw)	
Stripping length / Blade size	mm/-
Note	

IEC 60947-7-3

IEC	UL	CSA
400	600 (C)	600 (C)
57	40 (C)	63 (C)
10	AWG 14...6	AWG 14...6
6 kV / 3		
B7 / V-0		

Rated connection	
1.5...16 / 1.5...16	
1.5...16 / 1.5...16	
1.2...2.4 Nm (M 4)	
13 / 1.0 x 5.5 mm	

400 V also available with Neozed shipbuilding fuse. When connecting wires of 10 mm² or larger; the torque for stranded and 7-core AWG wires is 2 Nm.

Ordering data

Version	500 V AC/DC, w/o LED
Note	

Type	Qty.	Order No.
SAKS 5/35 DB	20	0502100000
Material Duroplast KRG		

Accessories

Screwable cross-connection	
	2-pole
	3-pole
	4-pole
	10-pole
	Lock washer
	Mounting screw
End plate / Partition plate	
	Dark beige Wemid
Screw cover cap	
	SK
Fuse cartridges	
Gauge rings	

Type	current	Qty.	Order No.
QL 2 SAKS2	36 A	20	0207800000
QL 4 SAKS2	36 A	20	0208000000
QL 10 SAKS2	36 A	20	0338900000
SS M4 D 128-A 4		100	0136400000
BFSC M4X9T		100	0103300000
Width			
WTW EN	3 mm	20	1058800000
SK E18 SAKS5		20	0359310000
E 18/20A BL		10	0361300000
E 18/25A GE		10	0361400000
E 18/35A SW		10	0361500000
P 18/20 D02 BL SAKS5		50	0361800000
P 18/25 D02 GE SAKS5		50	0361900000
P 18/35 D02 SW SAKS5		50	0362000000
P 18/50 D02 WS SAKS5		50	0362100000

Identification systems	(see assortment in catalogue 7)
	Marking tags
Note	

DEK 5/5
Replacement screw cover cap, Order no. 0359310000 (qty. 20).

Fuse terminals

In hazardous area applications, the installation instructions and the rated data specifications for accessories given in the technical appendix must be followed.

Width/Length/Height of lowest version	mm
max. current / max. cond. cross-section	A/mm ²
Max. clamping range	mm ²

Technical data

Rated data	
Rated voltage to adjoining terminal	V
Rated current	A
Rated cross-section	mm ²
Rated impulse withstand voltage / Pollution severity	
Gauge to IEC 60947-1 / Flammability class UL94	
Approvals	

Clamped conductors (H05V/H07V)

Solid / stranded	mm ²
Flexible / Flexible with ferrule	mm ²
Tightening torque range (terminal screw)	
Stripping length / Blade size	mm/-

2 conductors with same cross-section (H05V/H07V)

Solid / stranded	mm ²
Flexible / Flexible with ferrule	mm ²

Note

Ordering data

Version	
	400 V AC/DC, w/o LED
	10-36 V AC/DC, with LED
	30-70 V AC/DC, with LED
	60-150 V AC/DC, with LED
	140-250 V AC/DC, with LED

Note

Accessories

Pluggable cross-connection	
	2-pole
	3-pole
	4-pole
	10-pole

End plate / Partition plate

	Dark beige Wemid
	Dark beige Wemid

G-fuse cartridge, 5 x 20 mm (IEC 60127-2)

	0,25 A fast
	0,50 A fast
	1,00 A fast
	2,00 A fast

Screwdriver

	Standard
--	----------

Identification systems

(see assortment in catalogue 7)

Marking tags

Note

WTR 2.5/SI

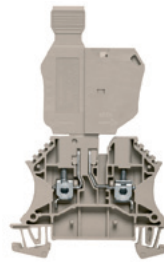
2.5 mm²

5.1 x 60 x 97.5
6.3 / 4
0.05...4

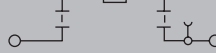

IEC 60947-7-3

IEC	UL	CSA
400	600 (C)	300 (B)
6.3	10 (C)	10 (B)
2.5	AWG 22...12	AWG 26...12
6 kV / 3		
A3 / V-0		



Rated connection

0.5...4 / 1.5...4
0.5...4 / 0.5...2.5
0.4 0.8 Nm (M 2.5)
10 / 0.6 x 3.5 mm

0.5...1.5

0.5...1.5 / 0.5...1.5

2.5 mm² wires with wire ferrules including the plastic collar only clampable with diameter-optimised collar (Order no. 1333100000, pack of 500).

Type	Qty.	Order No.
WTR 2.5/SI	25	1763940000
WTR 2.5/SI LD 36V	25	1763950000

UL/CSA specified for 400 V fuse cartridge; otherwise the specified voltage range is also valid for UL/CSA.

Type	current	Qty.	Order No.
ZQV 2.5N/2 GE	24 A	60	1693800000
ZQV 2.5N/3 GE	24 A	60	1693810000
ZQV 2.5N/4 GE	24 A	60	1693820000
ZQV 2.5N/10 GE	24 A	20	1693880000

Width

WAP 2.5-10	1.5 mm	50	1050000000
WAP 16+35 WTW 2.5-10	1.5 mm	20	1050100000

G 20/0.25A/F	10	0430500000
G 20/0.50A/F	10	0430600000
G 20/1.00A/F	10	0430700000
G 20/2.00A/F	10	0430900000

SDS 0.6X3.5X100	1	9008330000
-----------------	---	------------

DEK 5/5 / WS 12/5

Cross-connection options for WTR 2.5, refer to the "W-Series Accessories" section.

WTR 4/SI

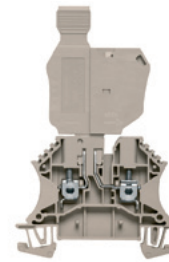
4 mm²

6.1 x 60 x 97.5
6.3 / 6
0.22...6



IEC 60947-7-3

IEC	UL	CSA
400	250 (C)	250 (D)
6.3	6.3 (C)	6.3 (D)
4	AWG 22...10	AWG 22...10
6 kV / 3		
A4 / V-0		



Rated connection

0.5...6 / 1.5...6
0.5...4 / 0.5...4
0.5 1 Nm (M 3)
13 / 0.6 x 3.5 mm

0.5...2.5

0.5...1.5 / 0.5...1.5

The rated current of the terminal is determined by the max. power loss of 1.6 W at the cartridge fuse.

Type	Qty.	Order No.
WTR 4 SI	25	7910240000
WTR 4/SI LD 36V	25	7914370000
WTR 4/SI LD 70V	25	7914380000
WTR 4/SI LD 150V	25	7914390000
WTR 4/SI LD 250V	25	7914400000

UL/CSA specified for 400 V fuse cartridge; otherwise the specified voltage range is also valid for UL/CSA.

Type	current	Qty.	Order No.
ZQV 4N/2 GE	32 A	60	1758250000
ZQV 4N/3 GE	32 A	60	1762630000
ZQV 4N/4 GE	32 A	60	1762620000
ZQV 4N/10 GE	32 A	20	1758260000

Width

WAP 2.5-10	1.5 mm	50	1050000000
WAP 16+35 WTW 2.5-10	1.5 mm	20	1050100000

G 20/0.25A/F	10	0430500000
G 20/0.50A/F	10	0430600000
G 20/1.00A/F	10	0430700000
G 20/2.00A/F	10	0430900000

SDS 0.6X3.5X100	1	9008330000
-----------------	---	------------

DEK 5/6 / WS 12/6

Cartridge fuses

Technical data

For terminal type

WSI 4
WSI 6



G-type cartridge fuses 5 x 20 without indicators to IEC 60127-2 (VDE 0820 pt.2 BI¹⁾

Size (mm)	Nom. current (A)	Type
5 x 20	0.1	(F) G 20/0.10A/F
	0.2	(F) G 20/0.20A/F
	0.25	(F) G 20/0.25A/F
	0.5	(F) G 20/0.50A/F
	0.63	(F) G 20/0.63A/F
	1.0	(F) G 20/1.00A/F
	1.6	(F) G 20/1.60A/F
	2.0	(F) G 20/2.00A/F
	2.5	(F) G 20/2.50A/F
	3.15	(F) G 20/3.15A/F
	4.0	(F) G 20/4.00A/F
	5.0	(F) G 20/5.00A/F
	6.3	(F) G 20/6.30A/F

breaking capacity 1500 A
(at 250 V, 50 Hz, cos φ 0.7)

(M) = medium-blow (F) = fast-blow

Ordering data

Qty.	Order No.
10	0430300000
10	0430400000
10	0430500000
10	0430600000
10	0439000000
10	0430700000
10	0430800000
10	0430900000
10	0431000000
10	0431100000
10	0431200000
10	0431300000
10	0431400000

D

WSI 6



G-type cartridge fuses 5 x 25 with indicators to DIN 41576¹⁾

Size (mm)	Nom. current (A)	Type
5 x 25 m. K. ¹⁾	0.25	(M) G 25/0.25A/M
	0.5	(M) G 25/0.50A/M
	0.8	(M) G 25/0.80A/M
	1	(M) G 25/1.00A/M
	10	(M) ²⁾ G 25/10.0A/M
	2	(F) G 25/2.00A/F
	4	(F) G 25/4.00A/F
	6.3	(F) G 25/6.30A/F

breaking capacity 80 A
(at 250 V, 50 Hz, cos φ = 1)

(M) = medium-blow (F) = fast-blow

10	0546900000
10	0510300000
10	0646400000
10	0265800000
10	0193100000
10	0192700000
10	0192800000
10	0192900000

WSI 4/2
WSI 6/2



Cartridge fuses 1 1/4" x 1/4" without indicators to BS 88

Size (mm)	Nom. current (A)	Type
33 kA breaking capacity, 33 kA fast-blow	0.5	GZ 0.5A/F
E 0.5 A	1	GZ 1.0A/F
E 1 A	2	GZ 2.0A
E 2 A	3	GZ 3.0A
E 3 A	5	GZ 5.0A
E 5 A	7	GZ 7.0A
E 7 A	10	GZ 10.0A
E 10 A	12.5	GZ 12.5A/FF

(M) = medium-blow (F) = fast-blow

10	0533800000
10	0525500000
10	0294500000
10	0295700000
10	0294600000
10	0295800000
10	0293900000
10	0245400000

SAKS 2



D-type cartridge fuses E 16 with indicators to DIN 49360 (Diazed)

Size (mm)	Nom. current (A)	Type
E 10 A	10	E 16/10A RT
E 16 A	16	E 16/16A GR
E 20 A	20	E 16/20A BL
E 25 A	25	E 16/25A GE

(M) = medium-blow (F) = fast-blow

25	0208500000
25	0208600000
25	0208700000
25	0208800000

SAKS 4 4)



D-type cartridge fuses E 14 size D 01 and E 18 size D 02 with indicators to DIN 49522 (Neozed)³⁾

Size (mm)	Nom. current (A)	Type
E 14/2	2	E 14/2A RS
E 14/4	4	E 14/4A BR
E 14/6	6	E 14/6A GN
E 14/10	10	E 14/10A RT
E 14/16	16	E 14/16A GR
E 18/20	20	E 18/20A BL
E 18/25	25	E 18/25A GE
E 18/35	35	E 18/35A SW
E 18/50	50	E 18/50A WS
E 18/63	63	E 18/63A KU

(M) = medium-blow (F) = fast-blow

10	0137400000
10	0137500000
10	0328300000
10	0328400000
10	0328500000
10	0361300000
10	0361400000
10	0361500000
10	0361600000
10	0361700000

SAKS 5



- Notes:
- 1) SIBA also supplies G-type cartridge fuses 5 x 25 with indicators suitable for 450 V~ shipbuilding applications.
 - 2) Cartridge fuses 5 x 30 (500 V~) for SAKS 3 are available from the WICKMANN company.
 - 3) LINDNER also supplies the Neozed cartridge fuses in another version suitable for 440 V~ shipbuilding applications.
 - 4) Cartridge fuses in the sizes 1"x1/4" (25.4 x 6.35 mm) and 13/32"x1 1/2" (10.3 x 38.1 mm) are not included in the range.
 - 5) For SAKS 1 and SAKS 7 only.

In photovoltaic applications, fusing of individual strings is needed.

Specially designed fuses should be used as this deals with DC voltages and current. AC fuses are not suitable.

The range from 2 to 20 Amperes and up to 1000 V DC can be covered with safety fuses, size 10 x 38 mm.

Safety fuses, 10 x 38 mm



Technical data

Electrical data	
Rated current	A
Rated voltage	V
Rated breaking capacity	
Melting integral	
Power output	
Additional data	
Size	mm
Test dropout voltage	
Characteristics	
Standard	

2	4	6	8	10	12	16	20
1000							
30 kA @ DC 1000 V (2 ms)							
3	10	45	5	7	10	30	52
1.2	1.8	2.5	1.6	2	2.4	2.1	2.5
10 x 38							
1000 V DC							
gPV/IEC (If = 1.45 x In)							
gR/UL E180276							
IEC 60 269-6; As at 2009							
UL 248-13							

Note



Ordering data

Note

Order No.	1224870000	1224880000	1224890000	1224900000	1224910000	1224920000	1224930000	1224950000
Qty.	10							

Gauge pieces

Technical data

For terminal type
SAKS 4/35

SAKS 5/35

SAKS 2/35

Gauge piece type	Amps	Colour	Type
P 14/2	2	pink	P 14/2D01 RS
P 14/4	4	brown	P 14/4D01 BR
P 14/6	6	green	P 14/6D01 GN
P 14/1	10	red	P 14/10D01 RT
P 18/20	20	blue	P 18/20D02 BL
P 18/25	25	yellow	P 18/25D02 GE
P 18/35	35	black	P 18/35D02 SW
P 18/50	50	white	P 18/50D02 WS
P 16/10	10	red	P 16/10 RT
P 16/16	16	grey	P 16/16 GR
P 16/20	20	blue	P 16/20 BL

Ordering data

Qty.	Order No.
50	0138000000
50	0138100000
50	0328600000
50	0328700000
50	0361800000
50	0361900000
50	0362000000
50	0362100000
100	0208900000
100	0209000000
100	0209100000

Test-disconnect terminals

Modular disconnect terminals enable circuits to be quickly isolated from the supply so that, for example, maintenance or repair work can be carried out.

In hazardous area applications, the installation instructions and the rated data specifications for accessories given in the technical appendix must be followed.

Width/Length/Height of lowest version	mm
max. current / max. cond. cross-section	A/mm ²
Max. clamping range	mm ²

Technical data

Rated data	
Rated voltage	V
Rated current	A
Rated cross-section	mm ²
Rated impulse withstand voltage / Pollution severity Gauge to IEC 60947-1 / Flammability class UL94	
Approvals	
Clamped conductors (H05V/H07V)	
Solid / stranded	mm ²
Flexible / Flexible with ferrule	mm ²
Tightening torque range (terminal screw)	
Stripping length / Blade size	mm/-
2 conductors with same cross-section (H05V/H07V)	
Solid / stranded	mm ²
Flexible / Flexible with ferrule	mm ²
Note	

Ordering data

Version	
	Dark beige Wemid
	Blue Wemid
	Without isolator, Dark beige Wemid
	Without STB
Note	

Accessories

Pluggable cross-connection	
	2-pole
	3-pole
	4-pole
	10-pole
End plate / Partition plate	
	Dark beige Wemid
	Dark beige Wemid
End bracket	
	Dark beige Wemid
Holder for cartridge fuse 5 x 20mm	
	400 V AC/DC, without LED
	10 - 36 V AC/DC, red LED
	140 - 250 V AC/DC, red LED
Module connector (max. 250 V)	
	without fittings
	with wire jumper
	With 1N4007 diode
Disconnect plug	
	removable, as replacement for release lever
Screwdriver	
	Standard
Identification systems	
	(see assortment in catalogue 7)
	Marking tags
Note	

WTR 2.5

2.5 mm²

With clamping screw

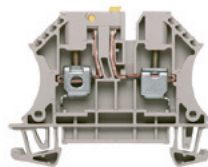

5.1 x 60 x 49
24 / 4
0.05...4



IEC 60947-7-1

IEC	UL	CSA
500	600 (C)	300 (C)
24	20 (C)	10 (C)
2.5	AWG 30...12	AWG 26...12
6 kV / 3		
A3 / V-0		



Rated connection	
0.5...4 / 1.5...4	
0.5...4 / 0.5...2.5	
0.4...0.8 Nm (M 2.5)	
10 / 0.6 x 3.5 mm	
0.5...1.5	
0.5...1.5 / 0.5...1.5	
2.5 mm ² conductor with ferrule with plastic collar, only with Order no. 1333100000 (500 pieces).	

Type	Qty.	Order No.
WTR 2.5	100	1855610000
WTR 2.5 BL	100	8731640000
WTR 2.5/0.TNHE	100	8731700000

Type	current	Qty.	Order No.
ZQV 2.5N/2 GE	24 A	60	1693800000
ZQV 2.5N/3 GE	24 A	60	1693810000
ZQV 2.5N/4 GE	24 A	60	1693820000
ZQV 2.5N/10 GE	24 A	20	1693880000
Width			
WAP 2.5-10	1.5 mm	50	1050000000
Width			
WEW 35/2	8 mm	100	1061200000
SIHA 3/G20	5.95 mm	25	7921560000
SIHA 3/G20/LD 10-36V	5.95 mm	25	7921570000
SIHA 3/G20/LD 140-250V	5.95 mm	25	7921600000
BEST	5.1 mm	50	1833100000
BEST/DRBR	5.1 mm	50	1878570000
BEST/D	5.1 mm	50	1878560000
TNST		50	1833090000
SDS 0.6X3.5X100		1	9008330000

DEK 5/5 / WS 12/5

WTR 2.5 STB

2.5 mm²

With sockets

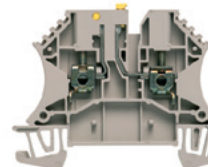

5.1 x 60 x 49
24 / 4
0.05...4



IEC 60947-7-1

IEC	UL	CSA
500	600 (C)	300 (D)
24	20 (C)	10 (D)
2.5	AWG 30...12	AWG 26...12
6 kV / 3		
A3 / V-0		



Rated connection	
0.5...4 / 1.5...4	
0.5...4 / 0.5...2.5	
0.5...0.7 Nm (M 3)	
10 / 0.6 x 3.5 mm	
0.5...1.5	
0.5...1.5 / 0.5...1.5	
2.5 mm ² conductor with ferrule with plastic collar, only with Order no. 1333100000 (500 pieces).	

Type	Qty.	Order No.
WTR 2.5 STB2.3	100	1855620000
WTR 2.5 STB2.3 BL	100	8731660000
WTR 2.5/0.TNHE STB2.3	100	8731670000

Type	current	Qty.	Order No.
ZQV 2.5N/2 GE	24 A	60	1693800000
ZQV 2.5N/3 GE	24 A	60	1693810000
ZQV 2.5N/4 GE	24 A	60	1693820000
ZQV 2.5N/10 GE	24 A	20	1693880000
Width			
WAP 2.5-10	1.5 mm	50	1050000000
Width			
WEW 35/2	8 mm	100	1061200000
SIHA 3/G20	5.95 mm	25	7921560000
SIHA 3/G20/LD 10-36V	5.95 mm	25	7921570000
SIHA 3/G20/LD 140-250V	5.95 mm	25	7921600000
BEST	5.1 mm	50	1833100000
BEST/DRBR	5.1 mm	50	1878570000
BEST/D	5.1 mm	50	1878560000
TNST		50	1833090000
SDS 0.6X3.5X100		1	9008330000

DEK 5/5 / WS 12/5

WTR 2.5/ZZ

2.5 mm²

Twin connection

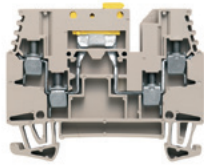

5.1 x 60 x 47
14 / 4
0.13...4

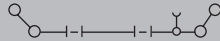

IEC 60947-7-1

IEC	UL	CSA
400	300 (D)	300 (D)
14	10 (D)	10 (D)
2.5	AWG 22...12	AWG 26...12
6 kV / 3		
A3 / V-0		



Rated connection

0.5...4 / 1.5...4
0.5...4 / 0.5...2.5
0.5...0.6 Nm (M 3)
7 / 0.6 x 3.5 mm

0.5...1.5
0.5...1.5 / 0.5...1.5

Type	Qty.	Order No.
WTR 2.5/ZZ	100	1039900000
WTR 2.5/ZZ BL	100	1039980000

2.5 mm² wires with wire ferrules including the plastic collar only clampable with diameter-optimised collar (Order no. 1333100000, pack of 500).

Type	current	Qty.	Order No.
ZQV 2.5/2	24 A	60	1608860000
ZQV 2.5/3	24 A	60	1608870000
ZQV 2.5/4	24 A	60	1608880000
ZQV 2.5/10	24 A	20	1608940000
Width			
WAP WTR2.5/ZZ	1.5 mm	20	1074600000
WEW 35/2	8 mm	100	1061200000
SIHA 1/G20	5.95 mm	25	9537550000
SIHA 1/G20 10-36V	5.95 mm	25	9537560000
SDS 0.6X3.5X100		1	9008330000

DEK 5/5 / WS 12/5

WTR 4

4 mm²

With clamping screw

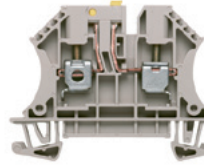

6.1 x 60 x 49
32 / 6
0.22...6



IEC 60947-7-1

IEC	UL	CSA
400	300 (D)	300 (C)
32	10 (D)	10 (C)
4	AWG 22...10	AWG 22...10
6 kV / 3		
A4 / V-0		



Rated connection

0.5...6 / 1.5...4
0.5...4 / 0.5...4
0.5...0.6 Nm (M 3)
13 / 0.6 x 3.5 mm

0.5...1.5
0.5...1.5 / 0.5...1.5

Type	Qty.	Order No.
WTR 4	50	7910180000
WTR 4 BL	50	7910190000

Type	current	Qty.	Order No.
ZQV 4N/2 GE	32 A	60	1758250000
ZQV 4N/3 GE	32 A	60	1762630000
ZQV 4N/4 GE	32 A	60	1762620000
ZQV 4N/10 GE	32 A	20	1758260000
Width			
WAP 2.5-10	1.5 mm	50	1050000000
WAP 16+35 WTW 2.5-10	1.5 mm	20	1050100000
WEW 35/2	8 mm	100	1061200000
SIHA 3/G20	5.95 mm	25	7921560000
SIHA 3/G20/LD 10-36V	5.95 mm	25	7921570000
SIHA 3/G20/LD 140-250V	5.95 mm	25	7921600000
BEST	5.1 mm	50	1833100000
BEST/DRBR	5.1 mm	50	1878570000
BEST/D	5.1 mm	50	1878560000
TNST		50	1833090000
SDS 0.6X3.5X100		1	9008330000

WS 12/5

WTR 4 STB

4 mm²

With socket

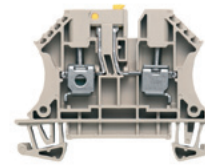

6.1 x 60 x 49
32 / 6
0.22...6

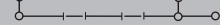

IEC 60947-7-1

IEC	UL	CSA
400	300 (C)	300 (D)
32	22 (C)	10 (D)
4	AWG 22...10	AWG 22...10
6 kV / 3		
A4 / V-0		



Rated connection

0.5...6 / 1.5...6
0.5...4 / 0.5...4
0.5...0.6 Nm (M 3)
13 / 0.6 x 3.5 mm

0.5...1.5
0.5...1.5 / 0.5...1.5

Type	Qty.	Order No.
WTR 4 STB	50	7910210000
WTR 4 STB BL	50	7910220000

Type	current	Qty.	Order No.
ZQV 4N/2 GE	32 A	60	1758250000
ZQV 4N/3 GE	32 A	60	1762630000
ZQV 4N/4 GE	32 A	60	1762620000
ZQV 4N/10 GE	32 A	20	1758260000
Width			
WAP 2.5-10	1.5 mm	50	1050000000
WAP 16+35 WTW 2.5-10	1.5 mm	20	1050100000
WEW 35/2	8 mm	100	1061200000
SIHA 3/G20	5.95 mm	25	7921560000
SIHA 3/G20/LD 10-36V	5.95 mm	25	7921570000
SIHA 3/G20/LD 140-250V	5.95 mm	25	7921600000
BEST	5.1 mm	50	1833100000
BEST/DRBR	5.1 mm	50	1878570000
BEST/D	5.1 mm	50	1878560000
TNST		50	1833090000
SDS 0.6X3.5X100		1	9008330000

WS 12/5

Test-disconnect terminals

Modular disconnect terminals enable circuits to be quickly isolated from the supply so that, for example, maintenance or repair work can be carried out.

In hazardous area applications, the installation instructions and the rated data specifications for accessories given in the technical appendix must be followed.

Width/Length/Height of lowest version	mm
max. current / max. cond. cross-section	A/mm ²
Max. clamping range	mm ²

Technical data

Rated data	
Rated voltage	V
Rated current	A
Rated cross-section	mm ²
Rated impulse withstand voltage / Pollution severity Gauge to IEC 60947-1 / Flammability class UL94	
Approvals	
Clamped conductors (H05V/H07V)	
Solid / stranded	mm ²
Flexible / Flexible with ferrule	mm ²
Tightening torque range (terminal screw)	
Stripping length / Blade size	mm/-
2 conductors with same cross-section (H05V/H07V)	
Solid / stranded	mm ²
Flexible / Flexible with ferrule	mm ²
Note	

Ordering data

Version	
Dark beige Wemid	
Blue Wemid	
Without isolator, Dark beige Wemid	
Without STB	
Note	

Accessories

Pluggable cross-connection	
	2-pole
	3-pole
	4-pole
	10-pole
End plate / Partition plate	
	Dark beige Wemid
	Dark beige Wemid
End bracket	
	Dark beige Wemid
Holder for cartridge fuse 5 x 20mm	
	400 V AC/DC, without LED
	10 - 36 V AC/DC, red LED
	140 - 250 V AC/DC, red LED
Module connector (max. 250 V)	
	without fittings
	with wire jumper
	With 1N4007 diode
Disconnect plug	
	removable, as replacement for release lever
Screwdriver	
	Standard
Identification systems	
	(see assortment in catalogue 7)
	Marking tags
Note	

WTR 4/ZZ

4 mm²

Twin connection with clamping screw

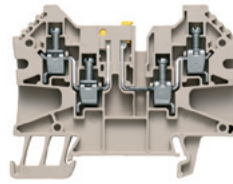

6.1 x 70 x 53.5	
27 / 6	
0.05...6	

IEC 60947-7-1

IEC	UL	CSA
500	600 (C)	600 (C)
27	25 (C)	25 (C)
4	AWG 30...10	AWG 30...10
6 kV / 3		
A4 / V-0		
Rated connection		
0.5...6 / 0.5...6		
0.5...4 / 0.5...4		
0.5...1 Nm (M 3)		
10 / 0.6 x 3.5 mm		
0.5...1.5		
0.5...1.5 / 0.5...1.5		

Type	Qty.	Order No.
WTR 4/ZZ	50	1905090000

Type	current	Qty.	Order No.
ZQV 4N/2 GE	32 A	60	1758250000
ZQV 4N/3 GE	32 A	60	1762630000
ZQV 4N/4 GE	32 A	60	1762620000
ZQV 4N/10 GE	32 A	20	1758260000
Width			
WAP WDU/WTR4/ZZ	1.5 mm	50	1905150000
Width			
WEW 35/2	8 mm	100	1061200000
SIHA 3/G20	5.95 mm	25	7921560000
SIHA 3/G20/LD 10-36V	5.95 mm	25	7921570000
SIHA 3/G20/LD 140-250V	5.95 mm	25	7921600000
BEST	5.1 mm	50	1833100000
BEST/DRBR	5.1 mm	50	1878570000
BEST/D	5.1 mm	50	1878560000
TNST		50	1833090000
SDS 0.6X3.5X100		1	9008330000
Width			
WS 12/5			

WTR 4/ZZ STB

4 mm²

Twin connection with socket

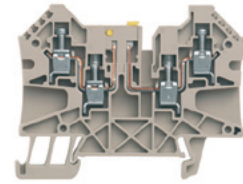

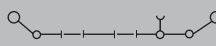
6.1 x 70 x 53.5	
27 / 6	
0.05...6	

IEC 60947-7-1

IEC	UL	CSA
500	600 (C)	600 (C)
27	25 (C)	25 (C)
4	AWG 30...10	AWG 30...10
6 kV / 3		
A4 / V-0		
Rated connection		
0.5...6 / 0.5...6		
0.5...4 / 0.5...4		
0.5...1 Nm (M 3)		
10 / 0.6 x 3.5 mm		
0.5...1.5		
0.5...1.5 / 0.5...1.5		

Type	Qty.	Order No.
WTR 4/ZZ STB	50	1905100000

Type	current	Qty.	Order No.
ZQV 4N/2 GE	32 A	60	1758250000
ZQV 4N/3 GE	32 A	60	1762630000
ZQV 4N/4 GE	32 A	60	1762620000
ZQV 4N/10 GE	32 A	20	1758260000
Width			
WAP WDU/WTR4/ZZ	1.5 mm	50	1905150000
Width			
WEW 35/2	8 mm	100	1061200000
SIHA 3/G20	5.95 mm	25	7921560000
SIHA 3/G20/LD 10-36V	5.95 mm	25	7921570000
SIHA 3/G20/LD 140-250V	5.95 mm	25	7921600000
BEST	5.1 mm	50	1833100000
BEST/DRBR	5.1 mm	50	1878570000
BEST/D	5.1 mm	50	1878560000
TNST		50	1833090000
SDS 0.6X3.5X100		1	9008330000
Width			
WS 12/5			

WTR 4/ZR

4 mm²

Supplementary connection, right, with clamping screw

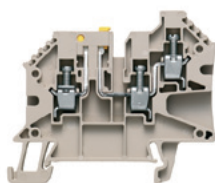

6.1 x 63.5 x 53.5
27 / 6
0.05...6

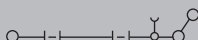

IEC 60947-7-1

IEC	UL	CSA
500	600 (C)	600 (C)
27	25 (C)	25 (C)
4	AWG 30...10	AWG 30...10
6 kV / 3		
A4 / V-0		



Rated connection

0.5...6 / 0.5...6

0.5...4

0.5...1 Nm (M 3)

10 / 0.6 x 3.5 mm

0.5...1.5 / 0.5...1.5

0.5...1.5 / 0.5...1.5

Type	Qty.	Order No.
WTR 4/ZR	50	1905080000

Type	current	Qty.	Order No.
ZQV 4N/2 GE	32 A	60	1758250000
ZQV 4N/3 GE	32 A	60	1762630000
ZQV 4N/4 GE	32 A	60	1762620000
ZQV 4N/10 GE	32 A	20	1758260000
Width		50	1905070000
WAP WDU/WTR4/ZR	1.5 mm		
WEW 35/2	8 mm	100	1061200000
SIHA 3/G20	5.95 mm	25	7921560000
SIHA 3/G20/LD 10-36V	5.95 mm	25	7921570000
SIHA 3/G20/LD 140-250V	5.95 mm	25	7921600000
BEST	5.1 mm	50	1833100000
BEST/DRBR	5.1 mm	50	1878570000
BEST/D	5.1 mm	50	1878560000
TNST		50	1833090000
SDS 0.6X3.5X100		1	9008330000

DEK 5/5 / WS 12/5

WTR 4/ZR STB

4 mm²

Supplementary connection, right, with socket

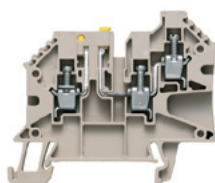

6.1 x 63.5 x 53.5
27 / 6
0.05...6



IEC 60947-7-1

IEC	UL	CSA
500	600 (C)	600 (C)
27	25 (C)	25 (C)
4	AWG 30...10	AWG 30...10
6 kV / 3		
A4 / V-0		



Rated connection

0.5...6 / 0.5...6

0.5...4 / 0.5...4

0.5...1 Nm (M 3)

10 / 0.6 x 3.5 mm

0.5...1.5

0.5...1.5 / 0.5...1.5

Type	Qty.	Order No.
WTR 4/ZR STB	50	1905110000

Type	current	Qty.	Order No.
ZQV 4N/2 GE	32 A	60	1758250000
ZQV 4N/3 GE	32 A	60	1762630000
ZQV 4N/4 GE	32 A	60	1762620000
ZQV 4N/10 GE	32 A	20	1758260000
Width		50	1905070000
WAP WDU/WTR4/ZR	1.5 mm		
WEW 35/2	8 mm	100	1061200000
SIHA 3/G20	5.95 mm	25	7921560000
SIHA 3/G20/LD 10-36V	5.95 mm	25	7921570000
SIHA 3/G20/LD 140-250V	5.95 mm	25	7921600000
BEST	5.1 mm	50	1833100000
BEST/DRBR	5.1 mm	50	1878570000
BEST/D	5.1 mm	50	1878560000
TNST		50	1833090000
SDS 0.6X3.5X100		1	9008330000

DEK 5/5 / WS 12/5

WDT 1.5/3

1.5 mm²

Disconnection lower level or both levels

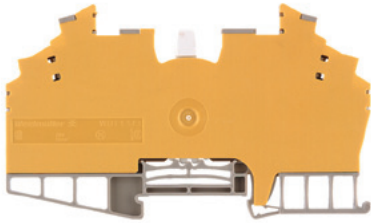

6.4 x 112 x 66.75
10 / 2.5
0.13...2.5



IEC 60947-7-1

IEC	UL	CSA
250	300 (C)	300 (D)
10	10 (C)	10 (D)
1.5	AWG 22...14	AWG 26...14
4 kV / 3		
A2 / V-2		



Rated connection

0.5...2.5 / 1.5...2.5
 0.5...1.5 / 0.5...1.5
 0.4...0.6 Nm (M 2.5)
 10 / 0.6 x 3.5 mm

...2.5

WDT 1.5/3 BL/HB Order no. 1016160000 flammability rating V2.

Type	Qty.	Order No.
WDT 1.5/3 DB/GE	25	1016000000
WDT 1.5/3 BL/HB	25	1016160000

Type	current	Qty.	Order No.
Width			
WEW 35/2	8 mm	100	1061200000
Width			
WEW 35/1	12 mm	50	1059000000
SIHA 1/G20	5.95 mm	25	9537550000
SIHA 1/G20 10-36V	5.95 mm	25	9537560000
Width			
SDS 0.6X3.5X100		1	9008330000

DEK 5/6.5 / WS 8/5

WDTR 2.5

2.5 mm²

Double disconnect terminal

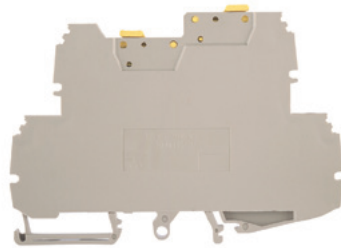

6.2 x 94 x 69.5
14 / 4
0.05...4

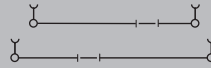

IEC 60947-7-1

IEC	UL	CSA
400	300 (C)	300 (D)
10	10 (C)	10 (D)
2.5	AWG 26...12	AWG 30...12
4 kV / 3		
A3 / V-0		



Rated connection

0.5...4 / 1.5...4
 0.5...2.5 / 0.5...2.5
 0.5...0.6 Nm (M 3)
 8 / 0.6 x 3.5 mm

0.5...1.5

0.5...1.5 / 0.5...1.5

Type	Qty.	Order No.
WDTR 2.5	25	9528070000
WDTR 2.5 BL	25	9528080000
WDTR 2.5 O.STB	25	1298020000

Type	current	Qty.	Order No.
Width			
WEW 35/1	12 mm	50	1059000000
SIHA 1/G20	5.95 mm	25	9537550000
SIHA 1/G20 10-36V	5.95 mm	25	9537560000
Width			
SDS 0.6X3.5X100		1	9008330000

DEK 5/6 / WS 8/5

External cross-connection is possible with the VQB 1.5/50. Refer to "Accessories" Chapter.

WDTR 2.5/WE

2.5 mm²

Double disconnect terminal

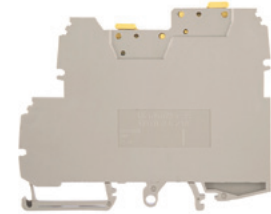

6.2 x 81 x 69.5
23 / 4
0.05...4

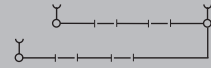

IEC 60947-7-1

IEC	UL	CSA
400		
10		
2.5		
4 kV / 3		
A3 / V-0		

Rated connection

0.5...4 / 1.5...4
 0.5...2.5 / 0.5...2.5
 0.5...0.6 Nm (M 3)
 8 / 0.6 x 3.5 mm

0.5...1.5

0.5...1.5 / 0.5...1.5

Type	Qty.	Order No.
WDTR 2.5/WE	25	9528090000
WDTR 2.5/WE O.STB	25	1297850000

Type	current	Qty.	Order No.
Width			
WEW 35/1	12 mm	50	1059000000
SIHA 1/G20	5.95 mm	25	9537550000
SIHA 1/G20 10-36V	5.95 mm	25	9537560000
Width			
SDS 0.6X3.5X100		1	9008330000

DEK 5/6 / WS 8/5

External cross-connection is possible with the VQB 1.5/50. Refer to "Accessories" Chapter.

Test-disconnect terminals

In hazardous area applications, the installation instructions and the rated data specifications for accessories given in the technical appendix must be followed.

Width/Length/Height of lowest version	mm
max. current / max. cond. cross-section	A/mm ²
Max. clamping range	mm ²

Technical data

Rated data	
Rated voltage	V
Rated current	A
Rated cross-section	mm ²
Rated impulse withstand voltage / Pollution severity	
Gauge to IEC 60947-1 / Flammability class UL94	
Approvals	
Clamped conductors (H05V/H07V)	
Solid / stranded	mm ²
Flexible / Flexible with ferrule	mm ²
Tightening torque range (terminal screw)	
Stripping length / Blade size	mm/-
2 conductors with same cross-section (H05V/H07V)	
Solid / stranded	mm ²
Flexible / Flexible with ferrule	mm ²
Note	

Ordering data

Version	
	Dark beige Wemid
	Without isolator, Dark beige Wemid
Note	

Accessories

Screwable cross-connection	
	2-pole
	3-pole
	4-pole
	10-pole
End plate / Partition plate	
	Dark beige Wemid
End bracket	
	Dark beige Wemid
Holder for cartridge fuse 5 x 20mm	
	400 V AC/DC, without LED
	10 - 36 V AC/DC, red LED
	140 - 250 V AC/DC, red LED
Module connector (max. 250 V)	
	without fittings
	with wire jumper
	With 1N4007 diode
Disconnect plug	
	removable, as replacement for release lever
Screwdriver	
	Standard
Identification systems	
	(see assortment in catalogue 7)
	Marking tags
Note	

WDK 2.5/TR-DU

2.5 mm²

NEW

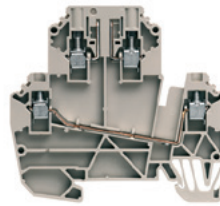

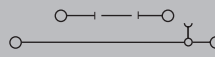
5.1 x 72.5 x 67	
/ 4	
0.5...4	

IEC	UL	CSA
690	300 (C)	300 (C)
24	20 (C)	20 (C)
2.5	AWG 30...12	AWG 30...12
8 kV / 3		
A2 / V-0		
® VDE		
Rated connection		
0.5...4 / 1.5...4		
0.5...4 / 0.5...2.5		
0.5...1 Nm (M 3)		
/ 0.6 x 3.5 mm		

Type	Qty.	Order No.
WDK 2.5/TR-DU	50	1247290000
WDK 2.5/TR-DU/o TNHE	50	1833600000

Type	current	Qty.	Order No.
WQV 2.5/2	32 A	50	1053660000
WQV 2.5/3	32 A	50	1053760000
WQV 2.5/4	32 A	50	1053860000
WQV 2.5/10	32 A	20	1054460000
Width			
WAP WDK 2.5N/TR-DU	1.5 mm	50	1839850000
WEW 35/1	12 mm	50	1059000000
SIHA 3/G20	5.95 mm	25	7921560000
SIHA 3/G20/LD 10-36V	5.95 mm	25	7921570000
SIHA 3/G20/LD 140-250V	5.95 mm	25	7921600000
BEST	5.1 mm	50	1833100000
BEST/DRBR	5.1 mm	50	1878570000
BEST/D	5.1 mm	50	1878560000
TNST		50	1833090000
SDS 0.6X3.5X100		1	9008330000

DEK 5/5 / WS 8/5

WDK 2.5/TR-DU/STB

2.5 mm²

NEW

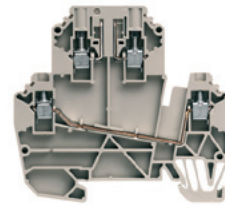

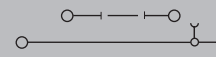
5.1 x 72.5 x 67	
/ 4	
0.5...4	

IEC	UL	CSA
690	300 (C)	300 (C)
24	20 (C)	20 (C)
2.5	AWG 30...12	AWG 30...12
8 kV / 3		
A2 / V-0		
® VDE		
Rated connection		
0.5...4 / 1.5...4		
0.5...4 / 0.5...2.5		
0.5...1 Nm (M 3)		
/ 0.6 x 3.5 mm		

Type	Qty.	Order No.
WDK 2.5/TR-DU STB	50	1247310000
WDK 2.5/TR-DU/o TNHE STB	50	1833610000

Type	current	Qty.	Order No.
WQV 2.5/2	32 A	50	1053660000
WQV 2.5/3	32 A	50	1053760000
WQV 2.5/4	32 A	50	1053860000
WQV 2.5/10	32 A	20	1054460000
Width			
WAP WDK 2.5N/TR-DU	1.5 mm	50	1839850000
WEW 35/1	12 mm	50	1059000000
SIHA 3/G20	5.95 mm	25	7921560000
SIHA 3/G20/LD 10-36V	5.95 mm	25	7921570000
SIHA 3/G20/LD 140-250V	5.95 mm	25	7921600000
BEST	5.1 mm	50	1833100000
BEST/DRBR	5.1 mm	50	1878570000
BEST/D	5.1 mm	50	1878560000
TNST		50	1833090000
SDS 0.6X3.5X100		1	9008330000

DEK 5/5 / WS 8/5

WDK 2.5/TR-DU-PE

2.5 mm²

NEW

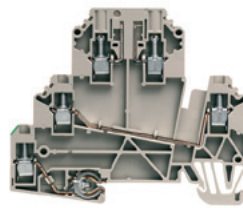

5.1 x 80.5 x 67
/ 4
0.5...4

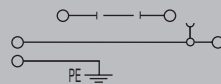

WDK 2.5/TR-DU-PE/STB

2.5 mm²

NEW

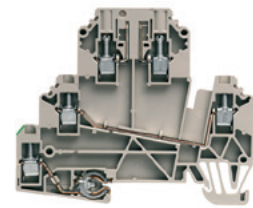

5.1 x 80.5 x 67
/ 4
0.5...4

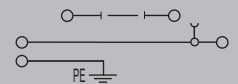

In hazardous area applications, the installation instructions and the rated data specifications for accessories given in the technical appendix must be followed.

Width/Length/Height of lowest version	mm
max. current / max. cond. cross-section	A/mm ²
Max. clamping range	mm ²

Technical data

Rated data	
Rated voltage	V
Rated current	A
Rated cross-section	mm ²
Rated impulse withstand voltage / Pollution severity	
Gauge to IEC 60947-1 / Flammability class UL94	
Approvals	
Clamped conductors (H05V/H07V)	
Solid / stranded	mm ²
Flexible / Flexible with ferrule	mm ²
Tightening torque range (terminal screw)	
Stripping length / Blade size	mm/-
2 conductors with same cross-section (H05V/H07V)	
Solid / stranded	mm ²
Flexible / Flexible with ferrule	mm ²
Note	

Ordering data

Version	Dark beige Wemid
	Without isolator, Dark beige Wemid
Note	

Accessories

Screwable cross-connection	
	2-pole
	3-pole
	4-pole
	10-pole
End plate / Partition plate	
	Dark beige Wemid
End bracket	
	Dark beige Wemid
Holder for cartridge fuse 5 x 20mm	
	400 V AC/DC, without LED
	10 - 36 V AC/DC, red LED
	140 - 250 V AC/DC, red LED
Module connector (max, 250 V)	
	without fittings
	with wire jumper
	With 1N4007 diode
Disconnect plug	
	removable, as replacement for release lever
Screwdriver	
	Standard

IEC	UL	CSA
690	300 (C)	300 (C)
24	20 (C)	20 (C)
2.5	AWG 30...12	AWG 30...12
8 kV / 3		
A2 / V-0		
Rated connection		
0.5...4 / 1.5...4		
0.5...4 / 0.5...2.5		
0.5...1 Nm (M 3)		
/ 0.6 x 3.5 mm		
Note		

Type	Qty.	Order No.
WDK 2.5/TR-DU-PE	50	1247420000
WDK 2.5/TR-DU-PE/STB	50	1833640000
Note		

Type	current	Qty.	Order No.
WQV 2.5/2	32 A	50	1053660000
WQV 2.5/3	32 A	50	1053760000
WQV 2.5/4	32 A	50	1053860000
WQV 2.5/10	32 A	20	1054460000
Width			
WAP WDK 2.5N/TR-DU	1.5 mm	50	1839850000
WEW 35/1	12 mm	50	1059000000
SIHA 3/G20	5.95 mm	25	7921560000
SIHA 3/G20/LD 10-36V	5.95 mm	25	7921570000
SIHA 3/G20/LD 140-250V	5.95 mm	25	7921600000
BEST	5.1 mm	50	1833100000
BEST/DRBR	5.1 mm	50	1878570000
BEST/D	5.1 mm	50	1878560000
TNST		50	1833090000
SDS 0.6X3.5X100		1	9008330000
Note			

IEC	UL	CSA
690	300 (C)	300 (C)
24	20 (C)	20 (C)
2.5	AWG 30...12	AWG 30...12
8 kV / 3		
A2 / V-0		
Rated connection		
0.5...4 / 1.5...4		
0.5...4 / 0.5...2.5		
0.5...1 Nm (M 3)		
/ 0.6 x 3.5 mm		
Note		

Type	Qty.	Order No.
WDK 2.5/TR-DU-PE STB	50	1247430000
WDK 2.5/TR-DU-PE/STB	50	1833670000
Note		

Type	current	Qty.	Order No.
WQV 2.5/2	32 A	50	1053660000
WQV 2.5/3	32 A	50	1053760000
WQV 2.5/4	32 A	50	1053860000
WQV 2.5/10	32 A	20	1054460000
Width			
WAP WDK 2.5N/TR-DU	1.5 mm	50	1839850000
WEW 35/1	12 mm	50	1059000000
SIHA 3/G20	5.95 mm	25	7921560000
SIHA 3/G20/LD 10-36V	5.95 mm	25	7921570000
SIHA 3/G20/LD 140-250V	5.95 mm	25	7921600000
BEST	5.1 mm	50	1833100000
BEST/DRBR	5.1 mm	50	1878570000
BEST/D	5.1 mm	50	1878560000
TNST		50	1833090000
SDS 0.6X3.5X100		1	9008330000
Note			

Identification systems	(see assortment in catalogue 7)
	Marking tags
Note	

DEK 5/5 / WS 8/5
Note

DEK 5/5 / WS 8/5
Note

Testing made easy

WTL 6/1 EN, WTD 6/1 EN, WTQ 6/1 EN

Current transformers may only be short-circuited or operated with a negligible load impedance because open current transformers "run hot" and destroy themselves. Apart from that, load impedances lead to measuring inaccuracies in electricity supply meters and hence to financial losses for their operators.

You can solve many switching tasks - clearly and affordably - with the WTL 6/1 EN test-disconnect terminal, the WTD 6/1 EN feed-through terminal, and the WTQ 6/1 EN cross-disconnect terminal.

The screws for connecting the conductors are only accessible after the current transformer has been short-circuited with the help of the short-circuit slider. This guarantees that the measuring instrument is not accidentally disconnected.

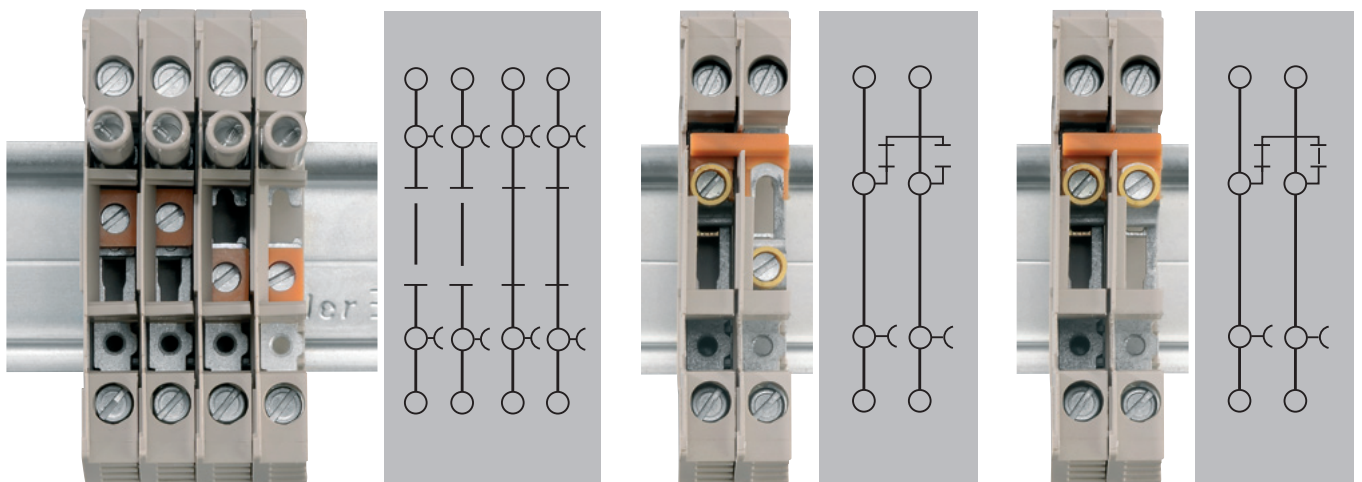
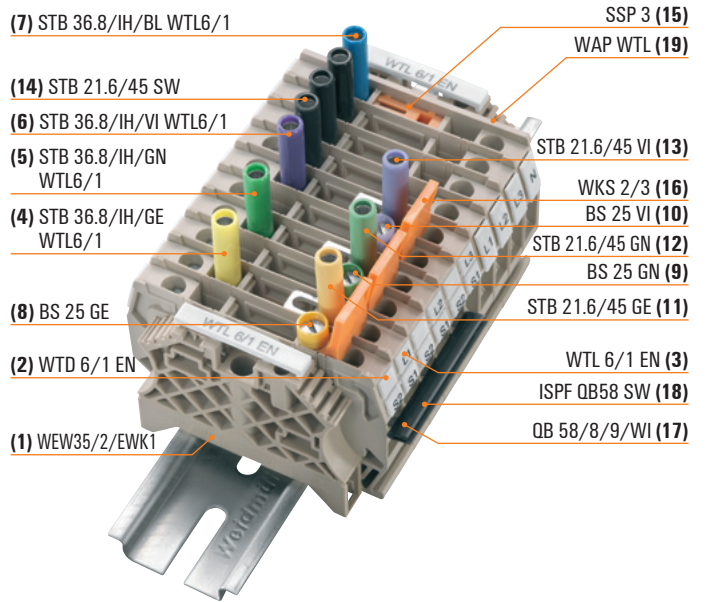

Example transformer using WTL 6/1 EN

Ordering data

Pos.	Type	Order No.	Order No.	Qty.
1	WEW35/2/EWK1	1061200000	0206160000	2
2	WTD 6/1 EN	1934830000	1934830000	3
3	WTL 6/1 EN	1934810000	1934810000	7
4	STB 36.8/IH/GE WTL6/1	1847760000	1847760000	1
5	STB 36.8/IH/GN WTL6/1	1847770000	1847770000	1
6	STB 36.8/IH/VI WTL6/1	1847780000	1847780000	1
7	STB 36.8/IH/BL WTL6/1	1847790000	1847790000	1
8	BS 25 GE	0335700000	0335700000	1
9	BS 25 GN	0335600000	0335600000	1
10	BS 25 VI	0335800000	0335800000	1
11	STB 21.6/45 GE	1936240000	1936240000	2
12	STB 21.6/45 GN	1936250000	1936250000	2
13	STB 21.6/45 VI	1936260000	1936260000	2
14	STB 21.6/45 SW	1936270000	1936270000	2
15	SSP 3	0531760000	0531760000	7
16	WKS 2/3	1936140000	1936140000	3
17	QB 58/8/9/WI	0545300000	0545300000	1
18	ISPF QB58 SW	0546000000	0546000000	1
19	WAP WTL	1957710000	1957710000	1
20	VH 16	0309700000	0309700000	9

Additionally available for a shared k-point:

Pos.	Type	Order No.	Order No.	Qty.
21	QB 58*angled	0545300000	0545300000	1
22	ISPFQB58SW*	0546000000	0546000000	1

* Shorten to 5 poles

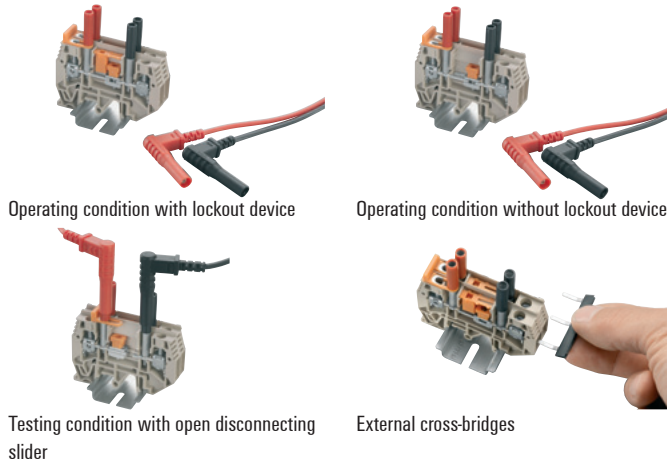

Operating status

(with external distribution of k-point)

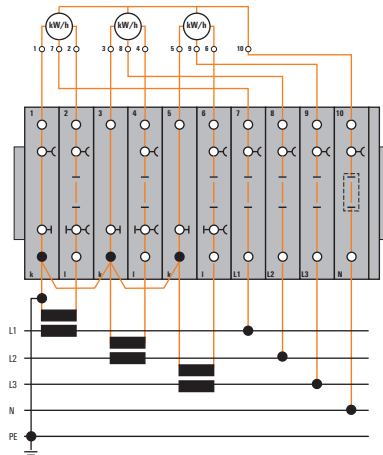

Comparison measurement for L1

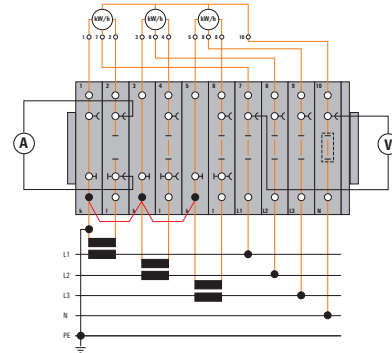

Operation depending on operating status:

1. Connect ammeter to test sockets at terminal 2.
2. Open disconnect slide link of terminals 2.
3. Connect voltmeter to test sockets of terminals 7 and 10.

Meter test for L1 through external power supply

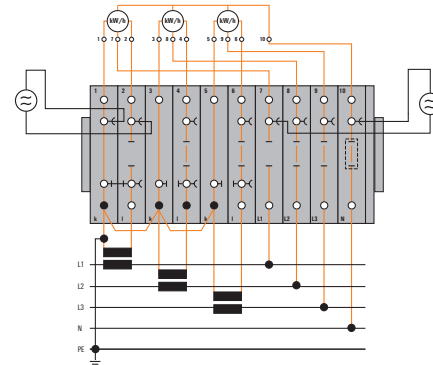

Operation depending on operating status:

1. Close the short-circuit slide of the terminals 1 and 2.
2. Open disconnect slide link of the terminals 2 and 7.
3. Connect external power supply to test sockets of terminals 1, 2 and 7, 10.

Changing the meter for L1

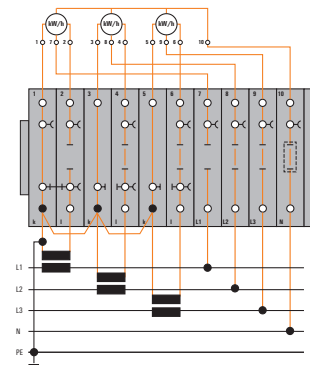

Operation depending on operating status:

1. Close short-circuit slide of the terminals 1 and 2.
2. Open disconnect slide link of the terminals 2 and 7.
3. Disconnect meter for L1 at the terminals 1, 2 and 7.

Testing made easy

WTL 6/1, WTD 6/1, WTQ 6/1

Current transformers may only be short-circuited or operated with a negligible load impedance because open current transformers "run hot" and destroy themselves. Apart from that, load impedances lead to measuring inaccuracies in electricity supply meters and hence to financial losses for their operators.

You can solve many switching tasks - clearly and affordably - with the WTL 6/1 test-disconnect terminal, the WTD 6/1 feed-through terminal, and the WTQ 6/1 cross-disconnect terminal.

The screws for connecting the conductors are only accessible after the current transformer has been short-circuited with the help of the short-circuit slider. This guarantees that the measuring instrument is not accidentally disconnected.

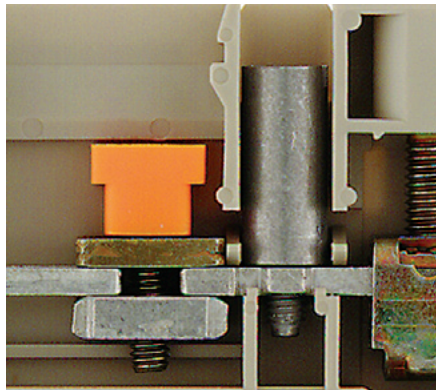
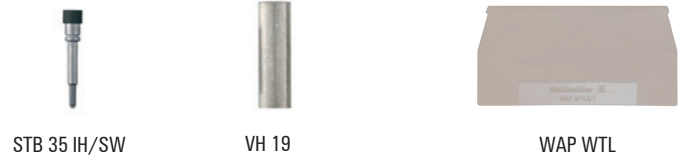
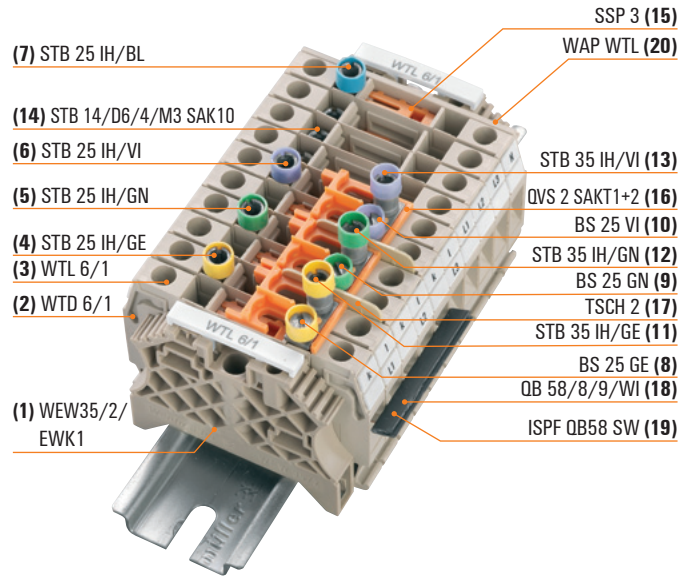

Sliding disconnector is easy to use (WTL 6/1)

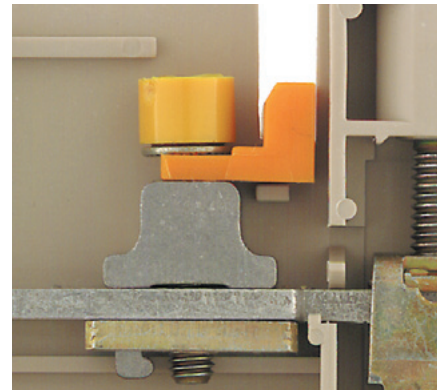

Safe disconnection of cross-connection (WTQ 6/1)

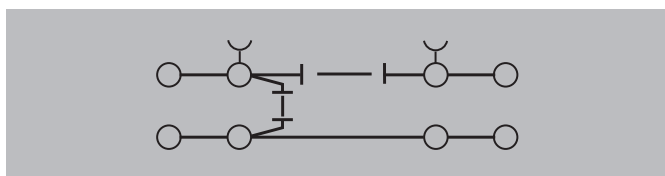

One short-circuit slider per terminal (WTL 6/1)

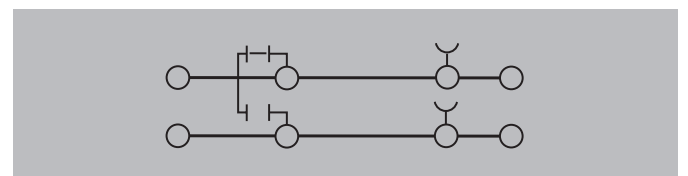

One short-circuit jumper per terminal (WTQ 6/1)

Example transformer using WTL 6/1

Ordering data

Pos.	Type	Order No.	Qty.
1	WEW35/2/EWK1	106120000	2
2	WTD 6/1	101710000	3
3	WTL 6/1	101670000	7
4	STB 25 IH/GE	026720000	1
5	STB 25 IH/GN	027120000	1
6	STB 25 IH/VI	027130000	1
7	STB 25 IH/BL	034340000	1
8	BS 25 GE	033570000	1
9	BS 25 GN	033560000	1
10	BS 25 VI	033580000	1
11	STB 35 IH/GE	038900000	2
12	STB 35 IH/GN	038890000	2
13	STB 35 IH/VI	038910000	2
14	STB 14/D6/4/M3 SAK10	016990000	2
15	SSP 3	053176000	7
16	QVS 2 SAKT1+2	030730000	1
17	TSCH 2	035366000	1
18	QB 58/8/9/WI	054530000	1
19	ISPF QB58 SW	054600000	1
20	WAP WTL	106830000	1
21	VH 19	031800000	9

Additionally available for a shared k-point:

Pos.	Type	Order No.	Order No.	Qty.
21	QB 58*angled	054530000	054530000	1
22	ISPFQB58SW*	054600000	054600000	1

* Shorten to 5 poles

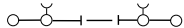
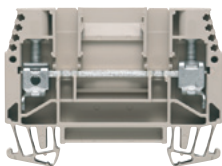

WTD 6/1

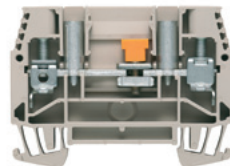

WTL 6/1

Operating status

(with external distribution of k-point)

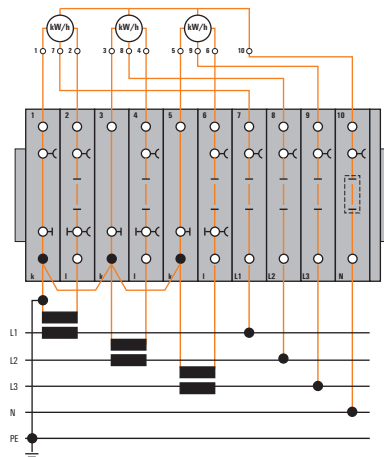

Comparison measurement for L1

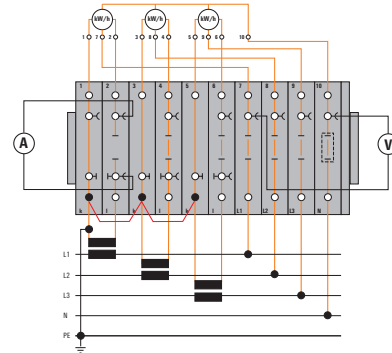

Operation depending on operating status:

1. Connect ammeter to test sockets at terminal 2.
2. Open disconnect slide link of terminals 2.
3. Connect voltmeter to test sockets of terminals 7 and 10.

Meter test for L1 through external power supply

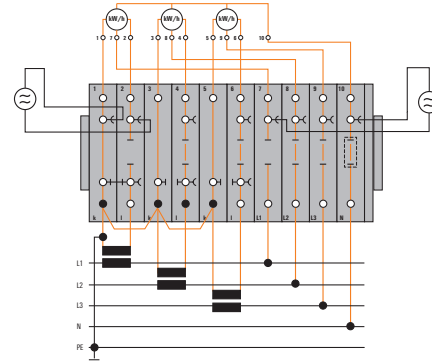

Operation depending on operating status:

1. Close the short-circuit slide of the terminals 1 and 2.
2. Open disconnect slide link of the terminals 2 and 7.
3. Connect external power supply to test sockets of terminals 1, 2 and 7, 10.

Changing the meter for L1

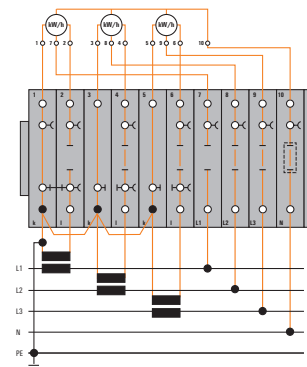

Operation depending on operating status:

1. Close short-circuit slide of the terminals 1 and 2.
2. Open disconnect slide link of the terminals 2 and 7.
3. Disconnect meter for L1 at the terminals 1, 2 and 7.

Convenient test-disconnect terminals WTL 6/2, WTL 6/3

All the circuits occurring in practice can be realised with the WTL 6/2 and WTL 6/3 terminals plus a few accessories.

The short-circuit sliders are finger-touch safe – no risk of electric shock. Two cross-connections, e.g. for internal distribution of the contact point, can also be incorporated. The standard WQV 6 cross-connections of the W-Series can be used here, which also permit terminals to be bypassed.

D

Thanks to the specially designed test sockets, both conventional test plugs and conventional safety test plugs can be used with the WTL 6/3.

Another advantage of the WTL 6/3 is that one screwdriver fits all screws and also all sockets.

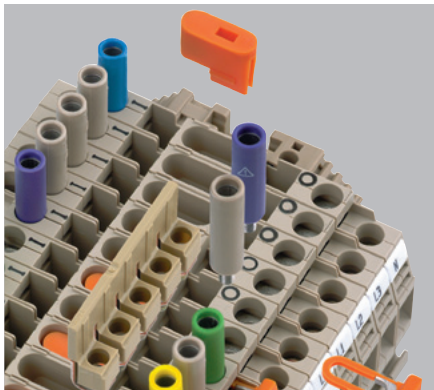
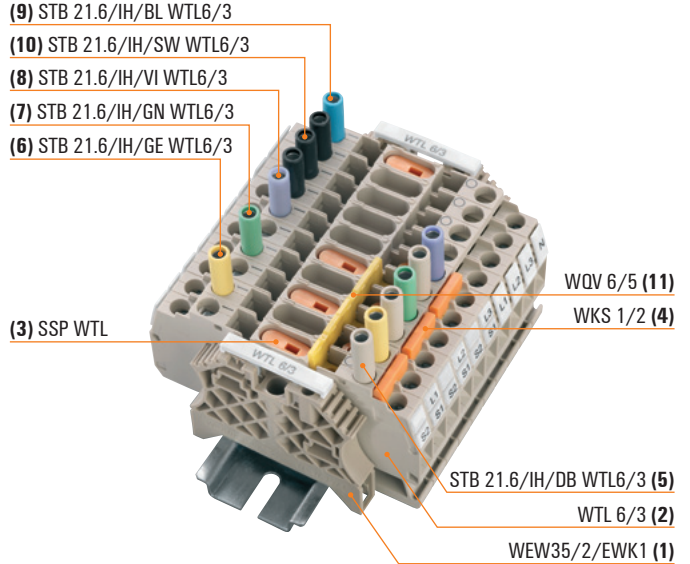

Optimised accessories for all circuit variations

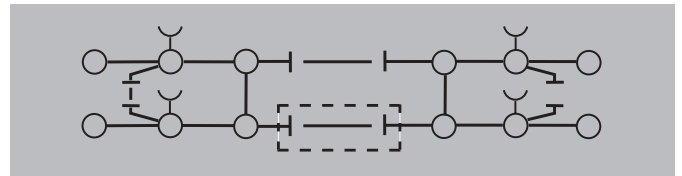

Variation with maximum accessories

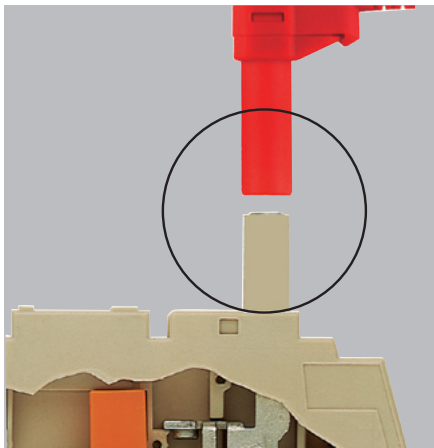

Safe test point according VGB 4

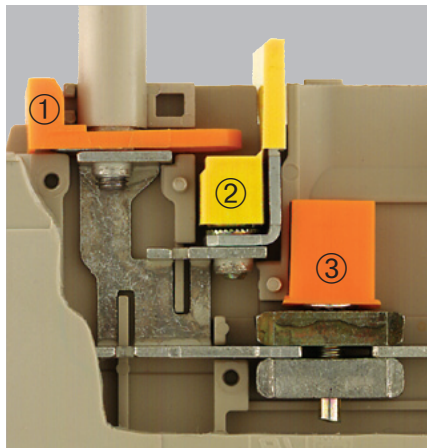

Compact design: ① sliding disconnect, ② cross-connection, ③ short-circuit slider



2 DEK markers per connection point

Example transformer using WTL 6/3

Ordering data

Pos.	Type	Order No.	Order No.	Qty.
1	WEW35/2/EWK1	1061200000	0206160000	2
2	WTL 6/3	1018800000	1018900000	10
3	SSP WTL	1604200000	1604200000	4
4	WKS 1/2	1604270000	1604270000	3

Optionally available for better labelling for WTL 6/3 (instead of 14 x pos. 3):

Pos.	Type	Order No.	Order No.	Qty.
5	STB 21.6/IH/DB WTL6/3	1071000000	1071000000	7
6	STB 21.6/IH/GE WTL6/3	1071010000	1071010000	2
7	STB 21.6/IH/GN WTL6/3	1071020000	1071020000	2
8	STB 21.6/IH/VI WTL6/3	1071030000	1071030000	2
9	STB 21.6/IH/BL WTL6/3	1071080000	1071080000	1
10	STB 21.6/IH/SW WTL6/3	1071040000	1071040000	3

Additionally available for a shared k-point:

Pos.	Type	Order No.	Order No.	Qty.
11	WQV 6/5	1062660000	1062660000	1



WTL 6/3/STB

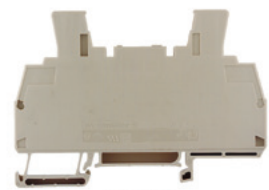

WTL 6/2

The disconnect test terminal WTL 6/3/STB offers the same functionality as the WTL 6/2. However, thanks to the special design of the test sockets both conventional test plugs as well as commercially available test plugs can be used.

Operating status

(with internal distribution of the k-point)

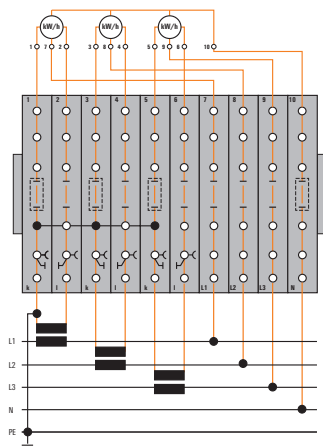

Comparison measurement for L1

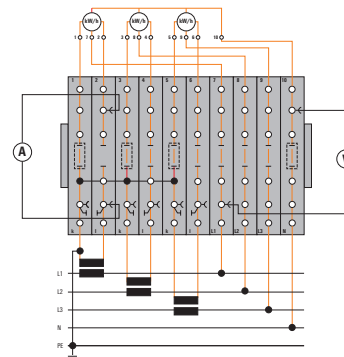

Operation depending on operating status:

1. Connect ammeter to test sockets at terminal 2.
2. Open disconnect slide link of terminals 2.
3. Connect voltmeter to test sockets of terminals 7 and 10.

Meter test for L1 through external power supply

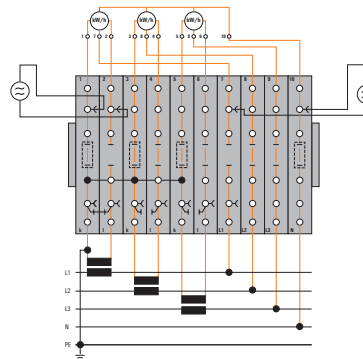

Operation depending on operating status:

1. Close the short-circuit slide of the terminals 1 and 2.
2. Open disconnect slide link of the terminals 2 and 7.
3. Connect external power supply to test sockets of terminals 1, 2 and 7, 10.

Changing the meter for L1

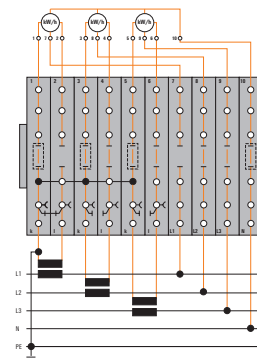

Operation depending on operating status:

1. Close short-circuit slide of the terminals 1 and 2.
2. Open disconnect slide link of the terminals 2 and 7.
3. Disconnect meter for L1 at the terminals 1, 2 and 7.

Testing made easy WTL 6 SL / WTD 6 SL

Current transformers may only be short-circuited or operated with a negligible load impedance because open current transformers "run hot" and destroy themselves. Apart from that, load impedances lead to measuring inaccuracies in electricity supply meters and hence to financial losses for their operators.

Many switching tasks can be done using the WTL 6 SL test/disconnect terminals and the WTD 6 SL feed-through terminals.

The screws for connecting the conductors are only accessible after the current transformer has been short-circuited with the help of the short-circuit slider. This guarantees that the measuring instrument is not accidentally disconnected.

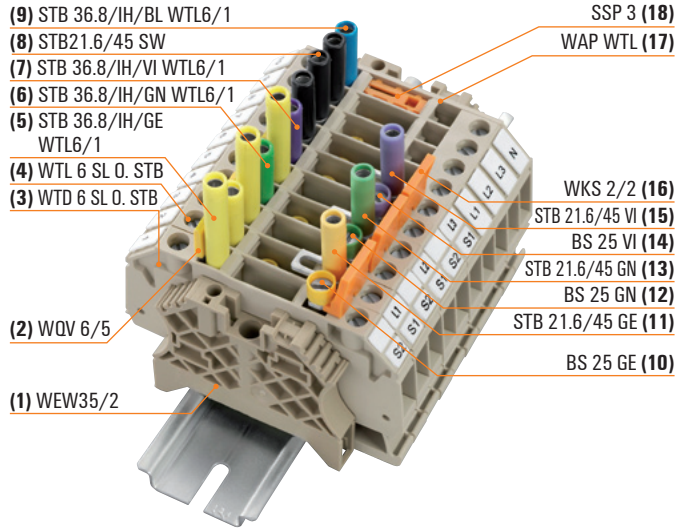

Example transformer using WTL 6 SL / WTD 6 SL

Ordering data

Pos.	Type	Order No.	Qty.
1	WEW35/2	1061200000	2
2	WQV 6/5	1062660000	1
3	WTD 6 SL 0. STB	1238920000	3
4	WTL 6 SL 0. STB	1238930000	7
5	STB 36.8/IH/GE WTL6/1	1847760000	4
6	STB 36.8/IH/GN WTL6/1	1847770000	1
7	STB 36.8/IH/VI WTL6/1	1847780000	1
8	STB21.6/45 SW	1936270000	3
9	STB 36.8/IH/BL WTL6/1	1847790000	1
10	BS 25 GE	0335700000	1
11	STB 21.6/45 GE	1936240000	1
12	BS 25 GN	0335600000	1
13	STB 21.6/45 GN	1936250000	1
14	BS 25 VI	0335800000	1
15	STB 21.6/45 VI	1936260000	1
16	WKS 2/2	1936150000	3
17	WAP WTL	9538110000	1
18	SSP 3	0531760000	1
19	GWHUE M3 WTL6	1255010000	3

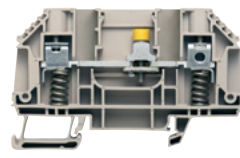
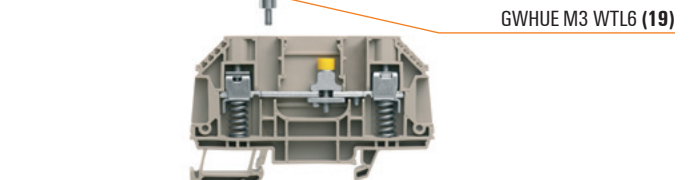
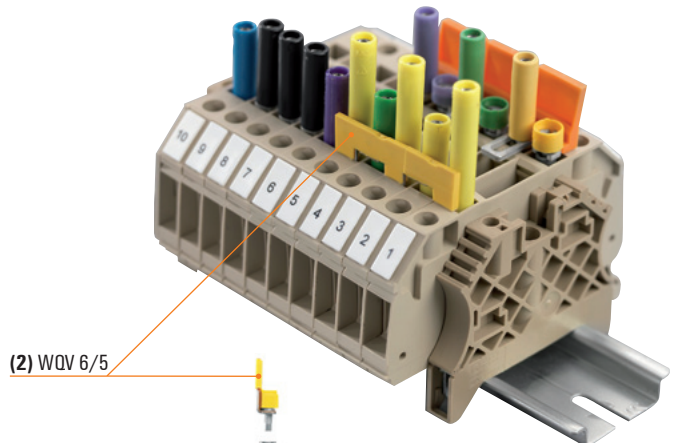

WTL 6 SL o. StB

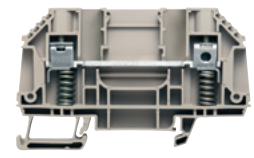

WTD 6 SL o. StB

Testing made easy

WTL 6 SL EN / WTD 6 SL EN

Current transformers may only be short-circuited or operated with a negligible load impedance because open current transformers "run hot" and destroy themselves. Apart from that, load impedances lead to measuring inaccuracies in electricity supply meters and hence to financial losses for their operators.

Many switching tasks can be done using the WTL 6 SL EN test/disconnect terminals and the WTD 6 SL EN feed-through terminals.

The screws for connecting the conductors are only accessible after the current transformer has been short-circuited with the help of the short-circuit slider. This guarantees that the measuring instrument is not accidentally disconnected.

Example transformer using WTL 6 SL EN / WTD 6 SL EN

Ordering data

Pos.	Type	Order No.	Qty.
1	WEW35/2	1061200000	2
2	WQV 6/5	1062660000	1
3	WTD 6 SL EN	9538100000	3
4	WTL 6 SL EN	9538080000	7
5	STB 36.8/IH/GE	1847760000	4
6	STB 36.8/IH/GN	1847770000	1
7	STB 36.8/IH/VI	1847780000	1
8	STB21.6/45 SW	1936270000	3
9	STB 36.8/IH/BL	1847790000	1
10	BS 25 GE	0335700000	1
11	STB 21.6/45 GE	1936240000	1
12	BS 25 GN	0335600000	1
13	STB 21.6/45 GN	1936250000	1
14	BS 25 VI	0335800000	1
15	STB 21.6/45 VI	1936260000	1
16	WKS 2/2	1936150000	3
17	WAP WTL	9538110000	1
18	SSP 3	0531760000	1
19	GWHUE M3 WTL6	1255010000	3

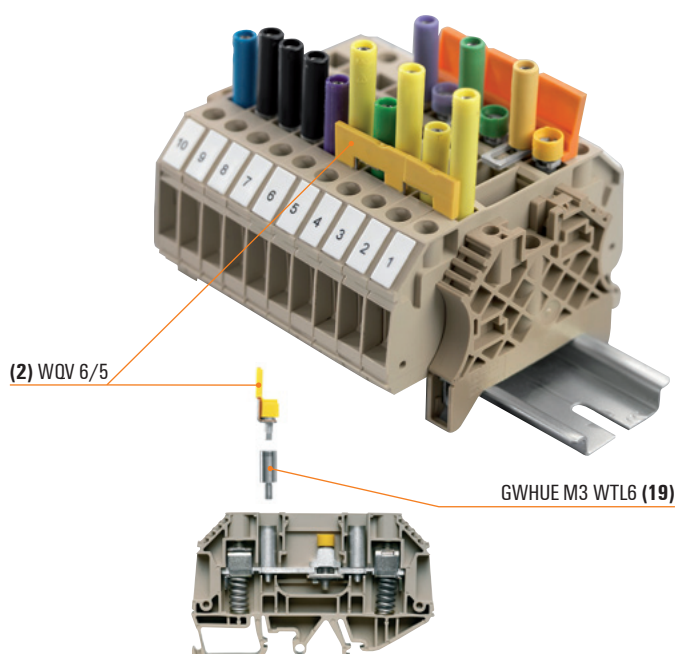
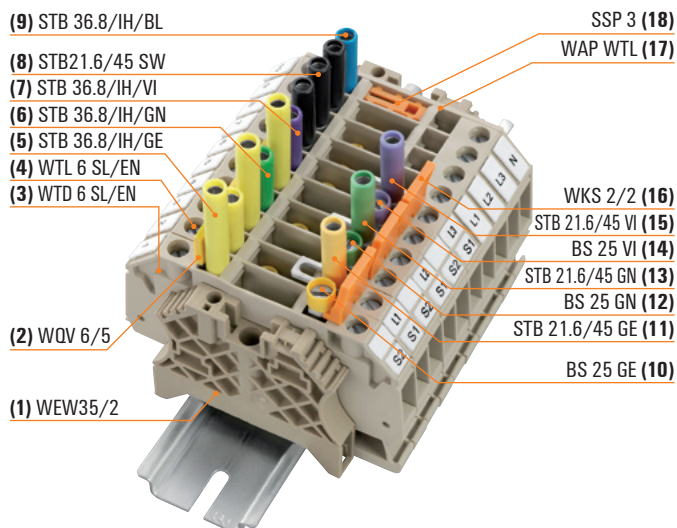

Test-disconnect terminals

Accessories for test-disconnect terminals WTL 6/1

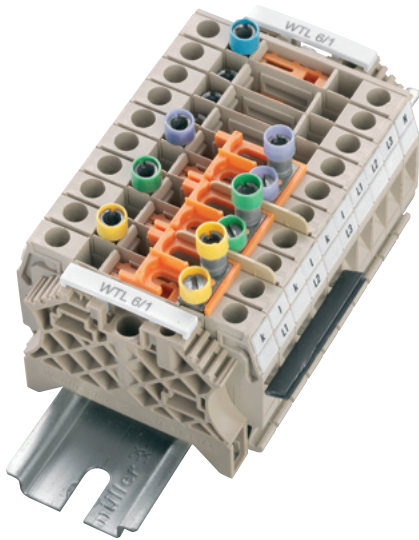

Cross-connection slider QVS ...

Connection sleeves VH 19 and fixing screws BS 25 (or sockets StB 35) are required for fastening the QVS in the individual terminals. The fixing screws have an insulating sleeve as colour marking and a screwdriver guide. Cross-connection sliders are designed so that the sockets inserted in the terminals remain available for test plugs at every position. The 2-pole version type QVS 2S is designed to slide with test plugs plugged in. If the option of testing is required when the QVS is plugged in, socket StB 35 can be used for fastening. The clearance and creepage sections required for the rated voltage of the terminal are changed when accessories are fitted.

Cross-connection slider STB

Sockets type **StB** are screwed into the busbar of the terminal. They take test plugs type PS4 or cross-connectors type QS2.

Technical data

Rated voltage for neighbouring	rated voltage
QVS	63 V
WQV	up to 400 V
QL	250 V

for neighbouring	rated voltage
STB 25	63 V
STB 30.5	63 V
STB 35	63 V

SSP WTL, SSP 3 and **SSP 4** prevent unwanted opening or closing of current circuits. They block the disconnecting slider in its particular position. The lockout device is easily pressed into the terminal, but can only be removed again with a tool.

Type	Qty.	Order No.
SSP 3	100	0531760000
SSP WTL	100	1604200000

To retain the rated voltage, partition plates **TW** or partition discs **TSch** have to be used, except with **WQV**.



QVS 1

Cross-connection slider



Type	No. of poles	Qty.	Order No.
QVS 2	2	20	0307300000
QVSK 2	2	20	1670360000
QVS 3	3	20	0329300000
QVS 4	4	20	0307400000
QVS 2S	2	20	0358460000

Note:
Not suitable for WTL 6/1 EN.
QVS 2 placed opposite each other cannot be switched.

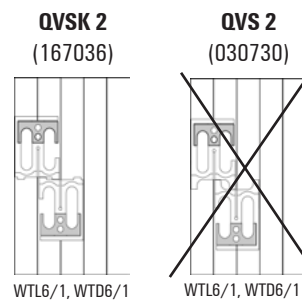

STB

Cross-connection slider



Type	Colour	Qty.	Order No.
STB 14		50	0169900000
STB 30.5			
STB 30.5	black	50	0341000000
STB 30.5	grey	50	0341100000
STB 30.5	blue	50	0341200000
STB 30.5	red	50	0341300000
STB 30.5	green	50	0341400000
STB 30.5	yellow	50	0341500000
STB 30.5	violet	50	0341600000
STB 35			
STB 35	yellow	50	0389000000
STB 35	green	50	0388900000
STB 35	violet	50	0389100000
STB 35	black	50	0388500000
STB 35	grey	50	0388600000
STB 35	blue	50	0388700000
STB 35	red	50	0388800000
Connecting sleeves			
VH19		50	0318000000

Accessories for test-disconnect terminals WTL 6/1 EN

BS fixing screws

VH connecting sleeves

WQV cross-connections

WQV cross-connections allow for finger and hand-safe connection between neighbouring terminals in accordance with VBG 4.

QL cross-connection lug

Model QL cross-connection links serve as fixed (i.e. non-switchable) cross-connections when used with WTL 6.1 test-disconnect terminals. They are fastened with connecting sleeves VH 12 and fixing screws BS M 3 x 20 (or sockets StB 30.5). The clearance and creepage distances required for the rated voltage of the terminal can be changed when accessories are installed. This applies in particular to the cross-connection of neighbouring terminals of differing potential.

WKB / WKS cross-connection bridge

WKB can be inserted from above in the case of cross-disconnect terminal type WTQ 6/1. The integrated disconnect slider is then responsible for connection or disconnection.

QS2 cross-connection plug

For sockets diameter 4 mm, for loads up to 44 A.

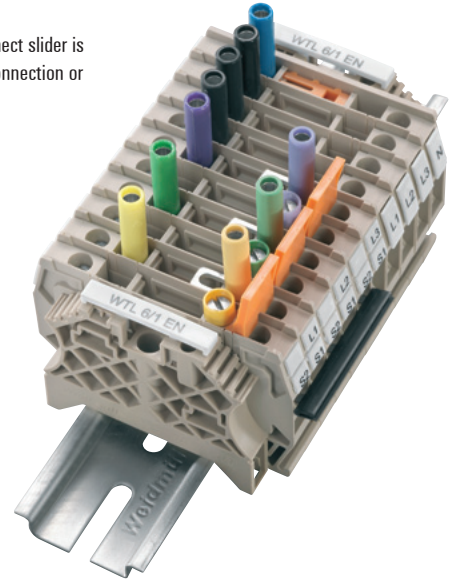

BS / VH



Type	Colour	Qty.	Order No.
Fixing screws			
BS 25	yellow	50	0335700000
BS 25	green	50	0335600000
BS 25	violet	50	0335800000
BS 25	grey	50	0335300000
BS 25	black	50	0335200000
BS 25	blue	50	0335400000
BS 25	red	50	0335500000
BS 25	blank	50	0334700000
STB 25			
STB 21.6/45 BL	blue	50	1936290000
STB 21.6/45 DB	d.blue	50	1938790000
STB 21.6/45 GE	yellow	50	1936240000
STB 21.6/45 GN	green	50	1936250000
STB 21.6/45 GR	grey	50	1936280000
STB 21.6/45 RT	red	50	1936300000
STB 21.6/45 SW	black	50	1936270000
STB 21.6/45 VI	violet	50	1936260000
Connecting sleeves			
VH 16/5/3,5 SAK10-35 CuZn 39 (brass alloy)		50	0309700000
STB 36.8			
STB 36.8/IH/DB WTL6/1		50	1847740000
STB 36.8/IH/GE WTL6/1		50	1847760000
STB 36.8/IH/GN WTL6/1		50	1847770000
STB 36.8/IH/VI WTL6/1		50	1847780000
STB 36.8/IH/BL WTL6/1		50	1847790000

WQV / QL

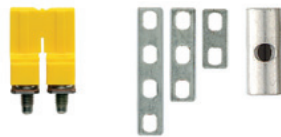

WQV (only for WTL 6/2, WTL 6/3)

Type	No. of poles	Qty.	Order No.
WQV			
WQV 6/2	2	50	1052360000
WQV 6/3	3	50	1054760000
WQV 6/4	4	50	1054860000
WQV 6/5	5	50	1062660000
WQV 6/7	7	50	1062680000
WQV 6/10	10	20	1052260000
QL			
QL 2	2	50	0194300000
QL 3	3	50	0194400000
QL 4	4	50	0194500000
QL 10	10	20	0338300000
QL 15	15	10	0221200000
Connecting sleeves			
VH 12		100	0249000000
E-Cu 57 (copper alloy)			

WKS / WKB



WKS

WKB

Type	No. of poles	Qty.	Order No.
WQV			
WKB 1/2	2	50	1604280000
WKB 1/3	3	50	1604300000
WKB 1/4	4	50	1604320000
WKB 1/10	10	20	1604330000
WKS			
WKS 1/2	2	50	1604270000
WKS 1/3	3	50	1604290000
WKS 1/4	4	50	1604310000
WKS 2/2	2	50	1936150000
WKS 2/3	3	50	1936140000

QS 2



Type	No. of poles	Qty.	Order No.
WQV			
QS 2	2	20	0270960000
x = 8 mm, y = 16 mm			
QS 2	2	20	0270860000
x = 10 mm, y = 20 mm			
QS 2	2	20	0270760000
x = 12 mm, y = 20 mm			

Test-disconnect terminals

Different current transformer circuits, e.g. for replacing measuring instruments or electricity meters, can be realised.

In hazardous area applications, the installation instructions and the rated data specifications for accessories given in the technical appendix must be followed.

Width/Length/Height of lowest version	mm
max. current / max. cond. cross-section	A/mm ²
Max. clamping range	mm ²

Technical data

Rated data	
Rated voltage	V
Rated current	A
Rated cross-section	mm ²
Rated impulse withstand voltage / Pollution severity Gauge to IEC 60947-1 / Flammability class UL94	
Approvals	
Clamped conductors (H05V/H07V)	
Solid / stranded	mm ²
Flexible / Flexible with ferrule	mm ²
Tightening torque range (terminal screw)	
Stripping length / Blade size	mm/-
Note	

Ordering data

Version	Without socket with socket
Note	

Accessories

Screwable cross-connection	
	2-pole 3-pole 4-pole 10-pole
End plate / Partition plate	
	Dark beige Wemid Dark beige Wemid
End bracket	
	Dark beige Wemid
Cross-connection slider	
	2-pole 3-pole 4-pole Connecting sleeve for QVS Mounting screw for QVS
Testing / Checking	
	Standard Test plug Socket - blue Socket - yellow Socket - green Socket - magenta Socket Socket - blue Socket - yellow Socket - green
Miscellaneous accessories	
	Lockout device
Identification systems (see assortment in catalogue 7)	
	Marking tags
Note	

WTL 4

4 mm²

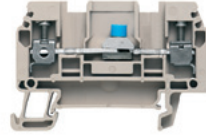

6.1 x 61.3 x 40.7
41 / 6
0.13...6

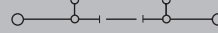

IEC 60947-7-1

IEC	UL	CSA
500	300 (C)	300 (D)
32	28 (C)	10 (D)
4	AWG 26...10	4
6 kV / 3		
A3 / V-0		
		
Rated connection		
0.5...6 / 1.5...4		
0.5...4 / 0.5...4		
0.4...0.7 Nm (M 2.5)		
10 / 0.6 x 3.5 mm		
Use as a disconnect terminal with 500 V.		

Type	Qty.	Order No.
WTL 4	50	1754960000
WTL 4/STB	50	1754970000

Type	current	Qty.	Order No.
WQV 4/2	32 A	50	1051960000
WQV 4/3	32 A	50	1054560000
WQV 4/4	32 A	50	1054660000
WQV 4/10	41 A	20	1052060000
Width			
ZAP/TW 1	2 mm	50	1608740000
Width			
WEW 35/2	8 mm	100	1061200000
current			
QVS 2/4 SAKT4	32 A	20	1319260000
Width			
BFSC M3X22 SAKT4		50	1319900000
Width			
PS 2.3 RT	5.4 mm	20	0180400000
Width			
STB 8.5/5/2.3/M3 SAK2.5		50	0280600000
Width			
DEK 5/6			

WTL 4/2

4 mm²

Enforced short-circuit function

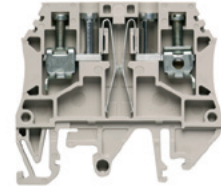

6 x 56.5 x 50
11 / 6
0.13...6

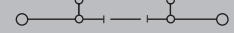

IEC 60947-7-1

IEC	UL	CSA
500	300 (D)	150 (C)
10	8 (D)	8 (C)
4	AWG 26...10	4
6 kV / 3		
A4 / V-0		
		
Rated connection		
0.5...6 / 1.5...6		
0.5...6 / 0.5...4		
0.5...0.8 Nm (M 3)		
10 / 0.6 x 3.5 mm		
2 wires can be connected; similar to the WDU 4N.		

Type	Qty.	Order No.
WTL 4/2 STB	50	1881650000

Type	current	Qty.	Order No.
Width			
WAP WTL4/2	2 mm	50	1881640000
Width			
WEW 35/2	8 mm	100	1061200000
Width			
WTA 8 TN	6 mm	25	1915450000
Width			
WS 12/6			
WTA 8-Series test adapter, WQV external cross-connection, end bracket and shield bus LS 2.8, refer to "Accessories"			

WTL 6/1 EN

6 mm²

Longitudinal - disconnect

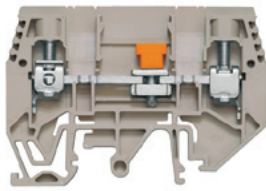

7.9 x 65 x 48.5
57 / 10
0.5...10

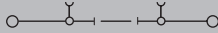

IEC 60947-7-1

IEC	UL	CSA
630	300 (C)	300 (C)
41	45 (C)	45 (C)
6	AWG 20...8	6
6 kV / 3		
A5 / V-0		



Rated connection

0.5...10 / 1.5...10

0.5...10 / 0.5...6

1...1.6 Nm (M 3.5)

12 / 4.0 x 0.8 mm

Use as 500 V disconnect terminal. Wire connection H07V-K10, H07V-R10 and AWG 8/7 with tightening torque of 1.4 Nm.

Type	Qty.	Order No.
WTL 6/1 EN	50	1934810000
WTL 6/1 EN STB	50	1934820000
TS32 version on request		

Type	current	Qty.	Order No.
WQV 6/2	57 A	50	1052360000
WQV 6/3	57 A	50	1054760000
WQV 6/4	57 A	50	1054860000
WQV 6/10	57 A	20	1052260000
Width			
WAP WTL6/1 EN	1.5 mm	20	1957710000
WTW WTL6/1 DB	1.5 mm	20	1068400000
current			
WEW 35/2	8 mm	100	1061200000
current			
WKS 2/2		50	1936140000
WKS 2/3		50	1936150000
WKS 2/4		50	1936160000
VH 16/5/3.5 SAK10-35		50	0309700000

Width			
STB 21.6/45 BL	6.1 mm	50	1936290000
STB 21.6/45 GE	6.1 mm	50	1936240000
STB 21.6/45 GN	6.1 mm	50	1936250000
current			
STB 14/D6/4/M3 SAK10		500	2012420000
STB 36.8/IH/BL WTL6/1	6 mm	50	1847790000
STB 36.8/IH/GE WTL6/1	6 mm	50	1847760000
STB 36.8/IH/GN WTL6/1	6 mm	50	1847770000

DEK 5/8 / WS 12/8

WTD 6/1 EN

6 mm²

Feed-through

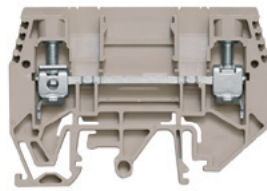

7.9 x 65 x 48.5
57 / 10
0.5...10

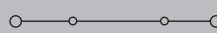

IEC 60947-7-1

IEC	UL	CSA
630	300 (C)	300 (C)
41	45 (C)	45 (C)
6	AWG 20...8	6
6 kV / 3		
A5 / V-0		



Rated connection

0.5...10 / 1.5...10

0.5...10 / 0.5...6

0.8...1.6 Nm (M 3.5)

12 / 4.0 x 0.8 mm

Wire connection H07V-K10, H07V-R10 and AWG 8/7 with tightening torque of 1.4 Nm.

Type	Qty.	Order No.
WTD 6/1 EN	50	1934830000
TS32 version on request		

Type	current	Qty.	Order No.
WQV 6/2	57 A	50	1052360000
WQV 6/3	57 A	50	1054760000
WQV 6/4	57 A	50	1054860000
WQV 6/10	57 A	20	1052260000
Width			
WAP WTL6/1 EN	1.5 mm	20	1957710000
WTW WTL6/1 DB	1.5 mm	20	1068400000
current			
WEW 35/2	8 mm	100	1061200000
current			
WKS 2/2		50	1936140000
WKS 2/3		50	1936150000
WKS 2/4		50	1936160000
VH 16/5/3.5 SAK10-35		50	0309700000

Width			
STB 21.6/45 BL	6.1 mm	50	1936290000
STB 21.6/45 GE	6.1 mm	50	1936240000
STB 21.6/45 GN	6.1 mm	50	1936250000
current			
STB 14/D6/4/M3 SAK10		500	2012420000
STB 36.8/IH/BL WTL6/1	6 mm	50	1847790000
STB 36.8/IH/GE WTL6/1	6 mm	50	1847760000
STB 36.8/IH/GN WTL6/1	6 mm	50	1847770000

DEK 5/8 / WS 12/8

WTQ 6/1 EN

6 mm²

Cross-connect/disconnect (isolator)

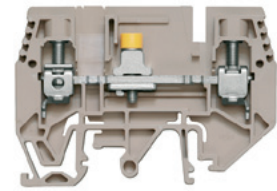

7.9 x 65 x 48.5
57 / 10
0.5...10

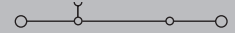

IEC 60947-7-1

IEC	UL	CSA
500	300 (C)	300 (C)
41	45 (C)	45 (C)
6	AWG 20...8	6
6 kV / 3		
A5 / V-0		



Rated connection

0.5...10 / 1.5...

0.5...10 / 0.5...6

(M 3.5)

12 / 4.0 x 0.8 mm

Wire connection H07V-K10, H07V-R10 and AWG 8/7 with tightening torque of 1.4 Nm.

Type	Qty.	Order No.
WTQ 6/1 EN	50	1934790000
WTQ 6/1 EN STB	50	1934800000
TS32 version on request		

Type	current	Qty.	Order No.
WQV 6/2	57 A	50	1052360000
WQV 6/3	57 A	50	1054760000
WQV 6/4	57 A	50	1054860000
WQV 6/10	57 A	20	1052260000
Width			
WAP WTL6/1 EN	1.5 mm	20	1957710000
WTW WTL6/1 DB	1.5 mm	20	1068400000
current			
WEW 35/2	8 mm	100	1061200000
current			
WKS 2/2		50	1936140000
WKS 2/3		50	1936150000
WKS 2/4		50	1936160000
VH 16/5/3.5 SAK10-35		50	0309700000

Width			
STB 21.6/45 BL	6.1 mm	50	1936290000
STB 21.6/45 GE	6.1 mm	50	1936240000
STB 21.6/45 GN	6.1 mm	50	1936250000
current			
STB 14/D6/4/M3 SAK10		500	2012420000
STB 36.8/IH/BL WTL6/1	6 mm	50	1847790000
STB 36.8/IH/GE WTL6/1	6 mm	50	1847760000
STB 36.8/IH/GN WTL6/1	6 mm	50	1847770000

DEK 5/8 / WS 12/8

Test-disconnect terminals

Different current transformer circuits, e.g. for replacing measuring instruments or electricity meters, can be implemented.

In hazardous area applications, the installation instructions and the rated data specifications for accessories given in the technical appendix must be followed.

Width/Length/Height of lowest version	mm
max. current / max. cond. cross-section	A/mm ²
Max. clamping range	mm ²

Technical data

Rated data	
Rated voltage	V
Rated current	A
Rated cross-section	mm ²
Rated impulse withstand voltage / Pollution severity Gauge to IEC 60947-1 / Flammability class UL94	
Approvals	
Clamped conductors (H05V/H07V)	
Solid / stranded	mm ²
Flexible / Flexible with ferrule	mm ²
Tightening torque range (terminal screw)	
Stripping length / Blade size	mm/-

Note

Ordering data

Version	
	Without socket
	with socket
Note	

Accessories

Screwable cross-connection	
	2-pole
	3-pole
	4-pole
	10-pole
End plate / Partition plate	
	Dark beige Wemid
	Dark beige Wemid
End bracket	
	Dark beige Wemid
Cross-connection slider	
	2-pole
	3-pole
	4-pole
	Connecting sleeve for QVS
	Mounting screw for QVS
Testing / Checking	
	Standard
	Test plug
	Socket - blue
	Socket - yellow
	Socket - green
	Socket - magenta
	Socket
	Socket - blue
	Socket - yellow
	Socket - green
Miscellaneous accessories	
	Lockout device
Identification systems	
	(see assortment in catalogue 7)
	Marking tags
Note	

WTL 6/1/STB/TNSC/EN

6 mm²

Longitudinal separator

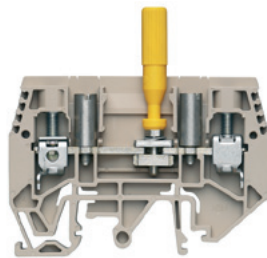

7.9 x 65 x 66.5

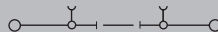
57 / 10
0.5...10

IEC 60947-7-1

IEC	UL	CSA
630	300 (C)	300 (C)
41	45 (C)	45 (C)
6	AWG 20...8	6
6 kV / 3		
A5 / V-0		



Rated connection

0.5...10 / 1.5...
0.5...10 / 0.5...6
1...1.6 Nm (M 3.5)
12 / 4.0 x 0.8 mm

Use as 500 V disconnect terminal. Wire connection H07V-K10, H07V-R10 and AWG 8/7 with tightening torque of 1.4 Nm.

Type	Qty.	Order No.
WTL 6/1/TNSC/EN	50	1345280000
WTL 6/1/STB/TNSC/EN	50	1938820000
TS32 version on request		

Type	current	Qty.	Order No.
WQV 6/2	57 A	50	1052360000
WQV 6/3	57 A	50	1054760000
WQV 6/4	57 A	50	1054860000
WQV 6/10	57 A	20	1052260000
Width			
WAP WTL6/1 EN	1.5 mm	20	1957710000
WTW WTL6/1 DB	1.5 mm	20	1068400000
WEW 35/2			
	8 mm	100	1061200000
current			
WKS 2/2		50	1936140000
WKS 2/3		50	1936150000
WKS 2/4		50	1936160000
VH 16/5/3.5 SAK10-35		50	0309700000
Width			
STB 21.6/45 BL	6.1 mm	50	1936290000
STB 21.6/45 GE	6.1 mm	50	1936240000
STB 21.6/45 GN	6.1 mm	50	1936250000
STB 14/D6/4/M3 SAK10		500	2012420000
DEK 5/8 / WS 12/8			

Different current transformer circuits, e.g. for replacing measuring instruments or electricity meters, can be realised.

In hazardous area applications, the installation instructions and the rated data specifications for accessories given in the technical appendix must be followed.

Width/Length/Height of lowest version	mm
max. current / max. cond. cross-section	A/mm ²
Max. clamping range	mm ²

Technical data

Rated data	
Rated voltage	V
Rated current	A
Rated cross-section	mm ²
Rated impulse withstand voltage / Pollution severity	
Gauge to IEC 60947-1 / Flammability class UL94	
Approvals	
Clamped conductors (H05V/H07V)	
Solid / stranded	mm ²
Flexible / Flexible with ferrule	mm ²
Tightening torque range (terminal screw)	
Stripping length / Blade size	
mm/-	
Note	

Ordering data

Version	Without socket with socket
Note	

Accessories

Screwable cross-connection	
	2-pole 3-pole 4-pole 10-pole
End plate / Partition plate	
	Dark beige Wemid Dark beige Wemid
End bracket	
	Dark beige Wemid
Cross-connection slider	
	2-pole 3-pole 4-pole Connecting sleeve for QVS Mounting screw for QVS
Testing / Checking	
	Standard Test plug Socket - blue Socket - yellow Socket - green Socket - magenta Socket Socket - blue Socket - yellow Socket - green
Miscellaneous accessories	
	Lockout device
Identification systems (see assortment in catalogue 7)	
	Marking tags
Note	

WTL 6/2

6 mm²

Longitudinal - disconnect

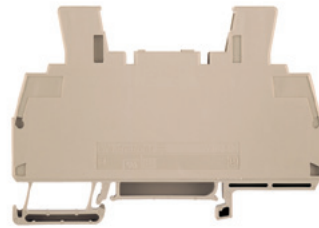

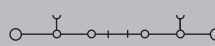
8 x 87 x 62	
57 / 10	
0.5...10	

IEC 60947-7-1

IEC	UL	CSA
500	300 (C)	300 (C)
41	45 (C)	45 (C)
6	AWG 20...8	6
6 kV / 3		
A5 / V-0		
Rated connection		
0.5...10 / 1.5...10		
0.5...10 / 0.5...6		
1...1.6 Nm (M 3.5)		
12 / 4.0 x 0.8 mm		
Wire connection H07V-K10, H07V-R10 and AWG 8/7 with tightening torque of 1.4 Nm.		

Type	Qty.	Order No.
WTL 6/2	50	1017700000
TS32 versions on request		

Type	current	Qty.	Order No.
WQV 6/2	57 A	50	1052360000
WQV 6/3	57 A	50	1054760000
WQV 6/4	57 A	50	1054860000
WQV 6/10	57 A	20	1052260000
Width			
WEW 35/2	8 mm	100	1061200000
current			
WKS 1/2		50	1604270000
WKS 1/3		50	1604290000
WKS 1/4		50	1604310000
Width			
PS 4 F.STB 4	7.6 mm	20	0299600000
Width			
SSP WTL6/2		100	1604200000
Width			
DEK 5/8 / WS 12/8			
For additional test and isolating terminal blocks accessories, refer to the "Accessories" chapter.			

WTL 6/3

6 mm²

Longitudinal - disconnect

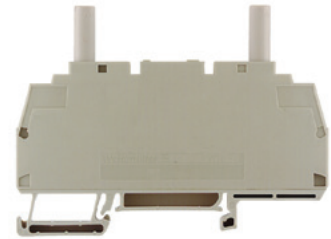

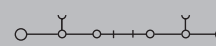
7.9 x 87 x 65	
57 / 10	
0.5...10	

IEC 60947-7-1

IEC	UL	CSA
500	300 (C)	300 (C)
41	45 (C)	45 (C)
6	AWG 20...8	6
6 kV / 3		
A5 / V-0		
Rated connection		
0.5...10 / 1.5...10		
0.5...10 / 0.5...6		
(M 3.5)		
12 / 4.0 x 0.8 mm		

Type	Qty.	Order No.
WTL 6/3	50	1018800000
WTL 6/3/STB	50	1018600000
TS32 versions on request		

Type	current	Qty.	Order No.
WQV 6/2	57 A	50	1052360000
WQV 6/3	57 A	50	1054760000
WQV 6/4	57 A	50	1054860000
WQV 6/10	57 A	20	1052260000
Width			
WEW 35/2	8 mm	100	1061200000
current			
WKS 1/2		50	1604270000
WKS 1/3		50	1604290000
WKS 1/4		50	1604310000
Width			
PS 4 F.STB 4	7.6 mm	20	0299600000
STB 21.6/IH/BL WTL6/3	6.2 mm	50	1071080000
STB 21.6/IH/GE WTL6/3	6.2 mm	50	1071010000
STB 21.6/IH/GN WTL6/3	6.2 mm	50	1071020000
STB 21.6/IH/VI WTL6/3	6.2 mm	50	1071030000
Width			
SSP WTL6/2		100	1604200000
Width			
DEK 5/8 / WS 12/8			
For additional test and isolating terminal blocks accessories, refer to the "Accessories" chapter.			

Test-disconnect terminals

WTL 6/4 FF

Longitudinal - disconnect

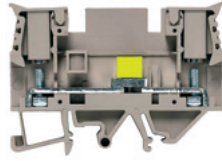

Width/Length/height	mm
Max. current / max. cond. cross-section	A/mm ²
Max. clamping range	mm ²

11 x 76.5 x 52
41 / 6
0.13 ... 6

Technical data

Rated data	
Rated voltage	V
Rated current	A
Rated cross-section	mm ²
Tightening torque range clamping screw / isolator	Nm
Approvals	
Note	

IEC 60947-7-1 / VDE 0100-537

IEC	UL	CSA	EN 60079-7
800	600	600	
500 V when used as test-disconnect terminal			
41	30	30	
6	AWG 26 ... 10	AWG 26...10	
1.2 ... 1.9 / 0.5 ... 0.8			

Ordering data

Version
Note

Type	Qty.	Order No.
WTL 6/4 FF	50	1887210000
Insulated cable lugs		

Accessories

Cross-connection	
ZQV: pluggable cross-connection	2-pole
End plate / partition	Dark beige Wemid
End bracket	
Screw	
Joint ferrule	
Cross-connection tabs	
Cross-connection	
Insulating sleeve	
Cross-connection plug	
Cable lug	
Tools	
Screwdriver	
Crimping tools	
Marking systems	Marking tags
For detailed information on other accessories and applications, refer to the "Accessories" section.	

Type	Qty.	Order No.
ZQV 10/2	25	1739680000
WAP WTL6/4FF	20	1887240000
EWK 1/TS 32	100	0206160000
WEW 35/2 / TS 35	100	1061200000
EW 35 /SCHA/M3	100	0258660000
BS M3x20		0303000000
VH 13.5		0248500000
QL 2 WTL 6/4 FF		1897010000
QL 3 WTL 6/4 FF		1897020000
QL 4 WTL 6/4 FF		1897030000
QL 10 WTL 6/4 FF		1897090000
QL 50 WTL 6/4 FF		1897100000
Q 2 WTL 6/4 FF		1897110000
Q 3 WTL 6/4 FF		1897120000
Q 4 WTL 6/4 FF		1897130000
Q 10 WTL 6/4 FF		1897190000
DS 13.5 WTL 6/4		1897000000
QS 2 (2-pole)		0270760000
LIR 1.5 M4 V		9200090000
LIR 2.5 M4 V		9200170000
LIR 6 M4 V		9200230000
SDI 0.8 x 4.0		9008400000
SD 0.8 x 4.0		9008340000
SDIZ 0.8 x 5.5		9008640000
CTI 6		9006120000
WS 10/5 / DEK 5		
For additional test-disconnect terminal accessories, refer to the Accessories Chapter.		

WTD 6/4 FF

Feed-through

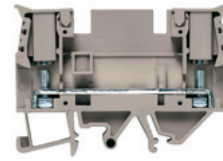

11 x 76.5 x 52
41 / 6
0.13 ... 6

IEC 60947-7-1 / VDE 0100-537

IEC	UL	CSA	EN 60079-7
800	600	600	
500 V when used as test-disconnect terminal			
41	30	30	
6	AWG 26 ... 10	AWG 26...10	
1.2 ... 1.9			

Type	Qty.	Order No.
WTD 6/4 FF	50	1887220000
Insulated cable lugs		

Type	Qty.	Order No.
ZQV 10/2	25	1739680000
WAP WTL6/4FF	20	1887240000
EWK 1/TS 32	100	0206160000
WEW 35/2 / TS 35	100	1061200000
EW 35 /SCHA/M3	100	0258660000
BS M3x20		0303000000
VH 13.5		0248500000
QL 2 WTL 6/4 FF		1897010000
QL 3 WTL 6/4 FF		1897020000
QL 4 WTL 6/4 FF		1897030000
QL 10 WTL 6/4 FF		1897090000
QL 50 WTL 6/4 FF		1897100000
Q 2 WTL 6/4 FF		1897110000
Q 3 WTL 6/4 FF		1897120000
Q 4 WTL 6/4 FF		1897130000
Q 10 WTL 6/4 FF		1897190000
DS 13.5 WTL 6/4		1897000000
QS 2 (2-pole)		0270760000
LIR 1.5 M4 V		9200090000
LIR 2.5 M4 V		9200170000
LIR 6 M4 V		9200230000
SDI 0.8 x 4.0		9008400000
SD 0.8 x 4.0		9008340000
SDIZ 0.8 x 5.5		9008640000
CTI 6		9006120000
WS 10/5 / DEK 5		
For additional test-disconnect terminal accessories, refer to the Accessories Chapter.		

Modular disconnect terminals enable circuits to be quickly isolated from the supply so that, for example, maintenance or repair work can be carried out.

In hazardous area applications, the installation instructions and the rated data specifications for accessories given in the technical appendix must be followed.

Width/Length/Height of lowest version	mm
max. current / max. cond. cross-section	A/mm ²
Max. clamping range	mm ²

Technical data

Rated data	
Rated voltage	V
Rated current	A
Rated cross-section	mm ²
Rated impulse withstand voltage / Pollution severity	
Gauge to IEC 60947-1 / Flammability class UL94	
Approvals	
Clamped conductors (H05V/H07V)	
Solid / stranded	mm ²
Flexible / Flexible with ferrule	mm ²
Tightening torque range (terminal screw)	
Stripping length / Blade size	mm/-
Note	

Ordering data

Version	Dark beige Wemid, 24 V
Note	

Accessories

End bracket	Dark beige Wemid
Screwdriver	Standard

Identification systems	(see assortment in catalogue 7) Marking tags
Note	

WTR 35 E

35 mm²



32 x 100 x 68
125 / 35
4...35

IEC	UL	CSA
24		
125		
35		
		0.8 kV / 3
		B9 / V-0

Rated connection	
4...16 / 10...35	
4...35 / 4...35	
4 Nm (M 6)	
18 / 1.2 x 6.5 mm	

Type	Qty.	Order No.
WTR 35 E	5	1045970000

Type	Width	Qty.	Order No.
WEW 35/1	12 mm	50	1059000000
SDS 1.2X6.5X150		1	9009010000

WS 12/6

Operation mode

Operating mode

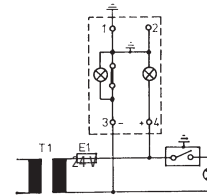

- Slide link is closed
- Auxiliary circuit is **earthed**
- Display is illuminated green

Test position

When measuring insulation resistance with voltages greater than U_{Nom}, the earth connection must first be disconnected.

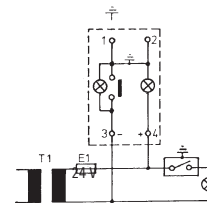

- Slide link is opened
- Auxiliary circuit is **not earthed**
- **No** earth fault
- Display illuminated green and red with reduced intensity
- Disconnected earth connection -> When measuring insulation resistance with voltages greater than U_{Nom}, the earth connection must be disconnected.

Operational malfunction

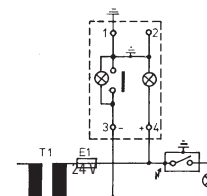

- Slide link is opened
- Auxiliary circuit is **not earthed**
- **Earth fault**
- Display is illuminated red

Installation terminals

Distribution terminal with WQV

N-busbars may not be used in certain applications (medical systems). Instead, installation terminals with a disconnecter in the centre of the terminal can be used.

In hazardous area applications, the installation instructions and the rated data specifications for accessories given in the technical appendix must be followed.

Width/Length/Height of lowest version	mm
max. current / max. cond. cross-section	A/mm ²
Max. clamping range	mm ²



Technical data

Rated data	
Rated voltage	V
Rated current	A
Rated cross-section AWG 26...12	mm ²
Rated impulse withstand voltage / Pollution severity Gauge to IEC 60947-1 / Flammability class UL94	
Approvals	
Clamped conductors (H05V/H07V)	
Solid / stranded	mm ²
Flexible / Flexible with ferrule	mm ²
Tightening torque range (terminal screw)	
Stripping length / Blade size	mm/-
Note	

Ordering data

Version	
	Dark beige Wemid
Note	

Accessories

Screwable cross-connection	
	2-pole
	3-pole
	4-pole
	10-pole
	20-/24-pole
End plate / Partition plate	
	Dark beige Wemid
Support bracket for 10 x 3 (required every 20 cm)	
	Dark beige Wemid
End bracket	
	Dark beige Wemid
Screwdriver	
	With "swifty set" cutting device
	Standard

Identification systems	(see assortment in catalogue 7)
	Marking tags
Note	

WDL 2.5/NT/L/PE

2.5 mm²

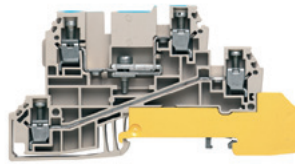

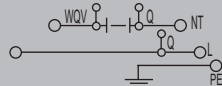
6.1 x 90 x 49	
32 / 4	
0.13...4	

IEC 60947-7-1 (-7-2)

IEC	UL	CSA
400	300 (C)	300 (D)
24	15 (C)	10 (D)
2.5	AWG 22...12	AWG 26...12
4 kV / 3		
A3, A4 / V-0		
Rated connection		
0.5...4 / 1.5...4		
0.5...4 / 0.5...2.5		
0.4...0.6 Nm (M 2.5)		
8 / 0.6 x 3.5 mm		
Further connection refers to clamping point at top left (A4) 2-conductor, 1.5 mm ² , solid, with 0.6 Nm.		

Type	Qty.	Order No.
WDL 2.5/NT/L/PE	50	1029800000
PE connection is marked green-yellow.		

Type	current	Qty.	Order No.
Q 2 WDL2.5S	24 A	50	1071500000
Q 3 WDL2.5S	24 A	50	1071600000
Q 4 WDL2.5S	24 A	50	1071700000
Q 10 WDL2.5S	24 A	20	1071800000
Q 20 WDL2.5S	24 A	20	1074200000
Width			
WAP WDL2.5	1.5 mm	20	1067800000
WHP WDL2.5/S BL	2 mm	20	1067980000
Width			
WEW 35/2	8 mm	100	1061200000
SWIFTY SET	18 mm	1	9006060000
SDIS 0.6X3.5X100		1	9008390000

Identification systems	(see assortment in catalogue 7)
	Marking tags
	DEK 5/5 / WS 8/5
Note	

WDL 2.5/L/L

2.5 mm²

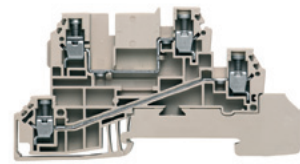

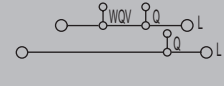
6.1 x 90 x 49	
32 / 4	
0.13...4	

IEC 60947-7-1

IEC	UL	CSA
400	300 (C)	300 (D)
24	15 (C)	10 (D)
2.5	AWG 22...12	AWG 26...12
6 kV / 3		
A3, A4 / V-0		
Rated connection		
0.5...4 / 1.5...4		
0.5...4 / 0.5...2.5		
0.4...0.6 Nm (M 2.5)		
8 / 0.6 x 3.5 mm		
Further connection refers to clamping point at top left (A4) 2-conductor, 1.5 mm ² , solid, with 0.6 Nm.		

Type	Qty.	Order No.
WDL 2.5/L/L	50	1030300000
WDL 2.5/N/L Order no. 1030000000 (upper connection is marked blue).		

Type	current	Qty.	Order No.
Q 2 WDL2.5S	24 A	50	1071500000
Q 3 WDL2.5S	24 A	50	1071600000
Q 4 WDL2.5S	24 A	50	1071700000
Q 10 WDL2.5S	24 A	20	1071800000
Q 20 WDL2.5S	24 A	20	1074200000
Width			
WAP WDL2.5	1.5 mm	20	1067800000
WHP WDL2.5/S BL	2 mm	20	1067980000
Width			
WEW 35/2	8 mm	100	1061200000
SWIFTY SET	18 mm	1	9006060000
SDIS 0.6X3.5X100		1	9008390000

Identification systems	(see assortment in catalogue 7)
	Marking tags
	DEK 5/5 / WS 8/5
Note	

WDL 2.5/N/L/PE

2.5 mm²

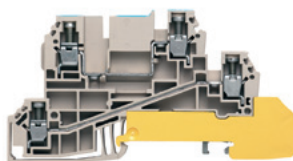

6.1 x 90 x 49
32 / 4
0.13...4

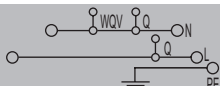

IEC 60947-7-1 (-7-2)

IEC	UL	CSA
400	300 (C)	300 (D)
24	15 (C)	10 (D)
2.5	AWG 22...12	AWG 26...12
4 kV / 3		
A3, A4 / V-0		



Rated connection

0.5...4 / 1.5...4
0.5...4 / 0.5...2.5
0.4...0.6 Nm (M 2.5)
8 / 0.6 x 3.5 mm

Further connection refers to clamping point at top left (A4)
2-conductor, 1.5 mm², solid, with 0.6 Nm.

Type	Qty.	Order No.
WDL 2.5/N/L/PE	50	1029900000

PE connection is marked green-yellow.

Type	current	Qty.	Order No.
Q 2 WDL2.5S	24 A	50	1071500000
Q 3 WDL2.5S	24 A	50	1071600000
Q 4 WDL2.5S	24 A	50	1071700000
Q 10 WDL2.5S	24 A	20	1071800000
Q 20 WDL2.5S	24 A	20	1074200000
Width			
WAP WDL2.5	1.5 mm	20	1067800000
WHP WDL2.5/S BL	2 mm	20	1067980000
WEW 35/2	8 mm	100	1061200000
SWIFTY SET	18 mm	1	9006060000
SDIS 0.6X3.5X100		1	9008390000

DEK 5/5 / WS 8/5

WDL 2.5/L/L/PE

2.5 mm²

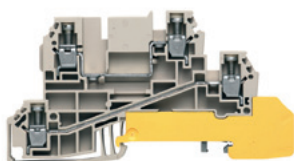

6.1 x 90 x 49
32 / 4
0.13...4

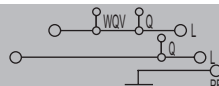

IEC 60947-7-1 (-7-2)

IEC	UL	CSA
400	300 (C)	300 (D)
24	15 (C)	10 (D)
2.5	AWG 22...12	AWG 26...12
4 kV / 3		
A3, A4 / V-0		



Rated connection

0.5...4 / 1.5...4
0.5...4 / 0.5...2.5
0.4...0.6 Nm (M 2.5)
8 / 0.6 x 3.5 mm

Further connection refers to clamping point at top left (A4)
2-conductor, 1.5 mm², solid, with 0.6 Nm.

Type	Qty.	Order No.
WDL 2.5/L/L/PE	50	1030200000

PE connection is marked green-yellow.

Type	current	Qty.	Order No.
Q 2 WDL2.5S	24 A	50	1071500000
Q 3 WDL2.5S	24 A	50	1071600000
Q 4 WDL2.5S	24 A	50	1071700000
Q 10 WDL2.5S	24 A	20	1071800000
Q 20 WDL2.5S	24 A	20	1074200000
Width			
WAP WDL2.5	1.5 mm	20	1067800000
WHP WDL2.5/S BL	2 mm	20	1067980000
WEW 35/2	8 mm	100	1061200000
SWIFTY SET	18 mm	1	9006060000
SDIS 0.6X3.5X100		1	9008390000

DEK 5/5 / WS 8/5

WDL 2.5/L

2.5 mm²

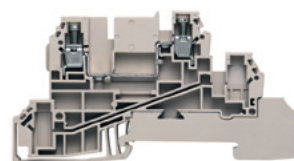

6.1 x 90 x 49
32 / 4
0.13...4



IEC 60947-7-1

IEC	UL	CSA
400	300 (C)	300 (D)
24	15 (C)	10 (D)
2.5	AWG 22...12	AWG 26...12
6 kV / 3		
A3, A4 / V-0		



Rated connection

0.5...4 / 1.5...4
0.5...4 / 0.5...2.5
0.4...0.6 Nm (M 2.5)
8 / 0.6 x 3.5 mm

Further connection refers to clamping point at top left (A4)
2-conductor, 1.5 mm², solid, with 0.6 Nm.

Type	Qty.	Order No.
WDL 2.5/L	50	1030400000

WDL 2.5/S/N Order no. 1030900000 (connection marked blue).

Type	current	Qty.	Order No.
Q 2 WDL2.5S	24 A	50	1071500000
Q 3 WDL2.5S	24 A	50	1071600000
Q 4 WDL2.5S	24 A	50	1071700000
Q 10 WDL2.5S	24 A	20	1071800000
Q 20 WDL2.5S	24 A	20	1074200000
Width			
WAP WDL2.5	1.5 mm	20	1067800000
WHP WDL2.5/S BL	2 mm	20	1067980000
WEW 35/2	8 mm	100	1061200000
SWIFTY SET	18 mm	1	9006060000
SDIS 0.6X3.5X100		1	9008390000

DEK 5/5 / WS 8/5

Installation terminals

Distribution terminals with 10 x 3 busbar

Space-saving wiring of three-phase circuits using only two terminals.

In hazardous area applications, the installation instructions and the rated data specifications for accessories given in the technical appendix must be followed.

Width/Length/Height of lowest version	mm
max. current / max. cond. cross-section	A/mm ²
Max. clamping range	mm ²



Technical data

Rated data	
Rated voltage	V
Rated current	A
Rated cross-section	mm ²
Rated impulse withstand voltage / Pollution severity Gauge to IEC 60947-1 / Flammability class UL94	
Approvals	
Clamped conductors (H05V/H07V)	
Solid / stranded	mm ²
Flexible / Flexible with ferrule	mm ²
Tightening torque range (terminal screw)	
Stripping length / Blade size	mm/-
Note	

Ordering data

Version	
	Dark beige Wemid
Note	

Accessories

Screwable cross-connection	
	2-pole
	3-pole
	4-pole
	10-pole
	20-/24-pole
End bracket	
	Dark beige Wemid
End plate / Partition plate	
	Dark beige Wemid
Support bracket for 10 x 3 (required every 20 cm)	
	Dark beige Wemid
Busbar 10 x 3 (140 A)	
	OK, Busbar up to OK, TS35 = 25,5 mm
Clamping yoke for power supply to 10 x 3 busbars	
	Rigid / flexible 0,5 - 6 / 4 mm ²
	Rigid / flexible 6 - 16 mm ²
	Flexible 16 - 35 mm ²

Identification systems	(see assortment in catalogue 7)
	Marking tags
Note	

WDL 2.5/S/NT/L/PE

2.5 mm²

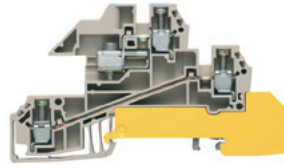

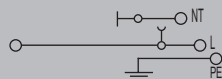
6.1 x 84.5 x 49	
32 / 4	
0.13...4	

IEC 60947-7-1 (-7-2)

IEC	UL	CSA
400	300 (C)	300 (D)
24	15 (C)	10 (D)
2.5	AWG 22...12	AWG 26...12
4 kV / 3		
A3 / V-0		
Rated connection		
0.5...4 / 1.5...4		
0.5...4 / 0.5...2.5		
0.4...0.6 Nm (M 2.5)		
8 / 0.6 x 3.5 mm		
Rated voltage of L-PE and L-NT: 250 V		
Tightening torque of isolator: 0.4...0.6 Nm		

Type	Qty.	Order No.
WDL 2.5/S/NT/L/PE	50	1030600000
PPE connection marked green/yellow, three-phase circuit together with WDL 2.5/S/L/L		

Type	current	Qty.	Order No.
Q 2 WDL2.5S	24 A	50	1071500000
Q 3 WDL2.5S	24 A	50	1071600000
Q 4 WDL2.5S	24 A	50	1071700000
Q 10 WDL2.5S	24 A	20	1071800000
Q 20 WDL2.5S	24 A	20	1074200000
Width			
WEW 35/2	8 mm	100	1061200000
WAP WDL2.5/S	1.5 mm	20	1067700000
WHP WDL2.5/S BL	2 mm	20	1067980000
SSCH 10X3X1000 CU/SN	10 mm	1	0348900000
ZB 4	5.6 mm	50	0316500000
ZB 16 ZKSC	10 mm	50	0316600000
ZB 35/M6X16	14 mm	20	0266500000

Identification systems	(see assortment in catalogue 7)
	Marking tags
DEK 5/5 / WS 8/5	
Note	

WDL 2.5/S/L/L

2.5 mm²

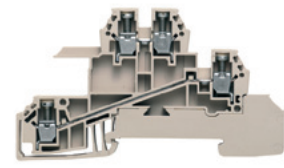

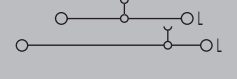
6.1 x 84.5 x 49	
32 / 4	
0.13...4	

IEC 60947-7-1

IEC	UL	CSA
400	300 (C)	300 (D)
24	15 (C)	10 (D)
2.5	AWG 22...12	AWG 26...12
6 kV / 3		
A3 / V-0		
Rated connection		
0.5...4 / 1.5...4		
0.5...4 / 0.5...2.5		
0.4...0.6 Nm (M 2.5)		
8 / 0.6 x 3.5 mm		
Rated voltage of L-PE and L-NT: 250 V		
Tightening torque of isolator: 0.4...0.6 Nm		

Type	Qty.	Order No.
WDL 2.5/S/L/L	50	1031200000
WDL 2.5/S/N/L Order no. 1030800000 (upper connection marked blue).		

Type	current	Qty.	Order No.
Q 2 WDL2.5S	24 A	50	1071500000
Q 3 WDL2.5S	24 A	50	1071600000
Q 4 WDL2.5S	24 A	50	1071700000
Q 10 WDL2.5S	24 A	20	1071800000
Q 20 WDL2.5S	24 A	20	1074200000
Width			
WEW 35/2	8 mm	100	1061200000
WAP WDL2.5/S	1.5 mm	20	1067700000
WHP WDL2.5/S BL	2 mm	20	1067980000
SSCH 10X3X1000 CU/SN	10 mm	1	0348900000
ZB 4	5.6 mm	50	0316500000
ZB 16 ZKSC	10 mm	50	0316600000
ZB 35/M6X16	14 mm	20	0266500000

Identification systems	(see assortment in catalogue 7)
	Marking tags
DEK 5/5 / WS 8/5	
Note	

WDL 2.5/S/N/L/PE

2.5 mm²

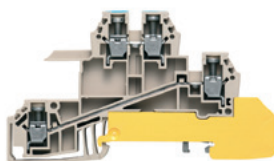

6.1 x 84.5 x 49
32 / 4
0.13...4

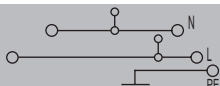

IEC 60947-7-1 (-7-2)

IEC	UL	CSA
400	300 (C)	300 (D)
24	15 (C)	10 (D)
2.5	AWG 22...12	AWG 26...12
4 kV / 3		
A3 / V-0		



Rated connection

0.5...4 / 1.5...4
0.5...4 / 0.5...2.5
0.4...0.6 Nm (M 2.5)
8 / 0.6 x 3.5 mm

L-PE / LN 250V

Type	Qty.	Order No.
WDL 2.5/S/N/L/PE	50	1030700000

PE connection is marked green-yellow.

WDL 2.5/S/L/L/PE

2.5 mm²

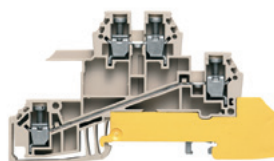

6.1 x 84.5 x 49
32 / 4
0.13...4

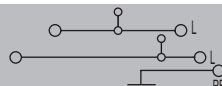

IEC 60947-7-1 (-7-2)

IEC	UL	CSA
400	300 (C)	300 (D)
24	15 (C)	10 (D)
2.5	AWG 22...12	AWG 26...12
4 kV / 3		
A3 / V-0		



Rated connection

0.5...4 / 1.5...4
0.5...4 / 0.5...2.5
0.4...0.6 Nm (M 2.5)
8 / 0.6 x 3.5 mm

L-PE 250V

Type	Qty.	Order No.
WDL 2.5/S/L/L/PE	50	1031100000

PE connection is marked green-yellow.

WDL 2.5/S/L

2.5 mm²

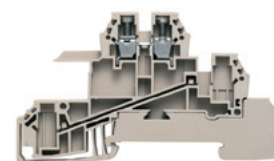

6.1 x 84.5 x 49
32 / 4
0.13...4

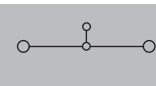

IEC 60947-7-1

IEC	UL	CSA
400	300 (C)	300 (D)
24	15 (C)	10 (D)
2.5	AWG 22...12	AWG 26...12
6 kV / 3		
A3 / V-0		



Rated connection

0.5...4 / 1.5...4
0.5...4 / 0.5...2.5
0.4...0.6 Nm (M 2.5)
8 / 0.6 x 3.5 mm

Type	Qty.	Order No.
WDL 2.5/S/L	50	1031300000

WDL 2.5/S/N Order no. 1030900000 (connection marked blue)

Type	current	Qty.	Order No.
Q 2 WDL2.5S	24 A	50	1071500000
Q 3 WDL2.5S	24 A	50	1071600000
Q 4 WDL2.5S	24 A	50	1071700000
Q 10 WDL2.5S	24 A	20	1071800000
Q 20 WDL2.5S	24 A	20	1074200000
Width			
WEW 35/2	8 mm	100	1061200000
WAP WDL2.5/S	1.5 mm	20	1067700000
WHP WDL2.5/S BL	2 mm	20	1067980000
SSCH 10X3X1000 CU/SN	10 mm	1	0348900000
ZB 4	5.6 mm	50	0316500000
ZB 16 ZKSC	10 mm	50	0316600000
ZB 35/M6X16	14 mm	20	0266500000

Type	current	Qty.	Order No.
Q 2 WDL2.5S	24 A	50	1071500000
Q 3 WDL2.5S	24 A	50	1071600000
Q 4 WDL2.5S	24 A	50	1071700000
Q 10 WDL2.5S	24 A	20	1071800000
Q 20 WDL2.5S	24 A	20	1074200000
Width			
WEW 35/2	8 mm	100	1061200000
WAP WDL2.5/S	1.5 mm	20	1067700000
WHP WDL2.5/S BL	2 mm	20	1067980000
SSCH 10X3X1000 CU/SN	10 mm	1	0348900000
ZB 4	5.6 mm	50	0316500000
ZB 16 ZKSC	10 mm	50	0316600000
ZB 35/M6X16	14 mm	20	0266500000

Type	current	Qty.	Order No.
Q 2 WDL2.5S	24 A	50	1071500000
Q 3 WDL2.5S	24 A	50	1071600000
Q 4 WDL2.5S	24 A	50	1071700000
Q 10 WDL2.5S	24 A	20	1071800000
Q 20 WDL2.5S	24 A	20	1074200000
Width			
WEW 35/2	8 mm	100	1061200000
WAP WDL2.5/S	1.5 mm	20	1067700000
WHP WDL2.5/S BL	2 mm	20	1067980000
SSCH 10X3X1000 CU/SN	10 mm	1	0348900000
ZB 4	5.6 mm	50	0316500000
ZB 16 ZKSC	10 mm	50	0316600000
ZB 35/M6X16	14 mm	20	0266500000

DEK 5/5 / WS 8/5

DEK 5/5 / WS 8/5

DEK 5/5 / WS 8/5

Installation terminals

Neutral conductor disconnect terminals

These special modular terminals are specified for insulation measurements, without disconnecting the conductor according to VDE standards, for places of public assembly.

In hazardous area applications, the installation instructions and the rated data specifications for accessories given in the technical appendix must be followed.

Width/Length/Height of lowest version	mm
max. current / max. cond. cross-section	A/mm ²
Max. clamping range	mm ²



Technical data

Rated data	
Rated voltage	V
Rated current	A
Rated cross-section	mm ²
Rated impulse withstand voltage / Pollution severity	
Gauge to IEC 60947-1 / Flammability class UL94	
Approvals	
Clamped conductors (H05V/H07V)	
Solid / stranded	mm ²
Flexible / Flexible with ferrule	mm ²
Tightening torque range (terminal screw)	
Stripping length / Blade size	mm/-
Note	

Ordering data

Version	
	Dark beige Wemid
	Blue Wemid
Note	

Accessories

End plate / Partition plate	
	Dark beige Wemid
	Blue Wemid
Support bracket for 10 x 3 (required every 20 cm)	
	Blue Wemid
	
End bracket	
	Dark beige Wemid
Screwdriver	
	With "swifty set" cutting device
	Standard
Busbar 10 x 3 (140 A)	
	OK, Busbar up to OK, TS35 = 25,5 mm
Clamping yoke for power supply to 10 x 3 busbars	
	Rigid / flexible 0,5 - 6 / 4 mm ²
	Rigid / flexible 6 - 16 mm ²
	Flexible 16 - 35 mm ²
	

Identification systems	
	(see assortment in catalogue 7)
	Marking tags
Note	

WNT 2.5

2.5 mm²

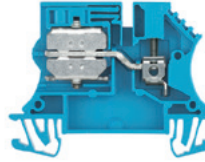

5.1 x 60 x 47	
32 / 4	NT
0.13...4	

IEC 60947-7-1

IEC	UL	CSA
400	600 (C)	600 (C)
24	25 (C)	20 (C)
2.5	AWG 22...12	AWG 26...12
6 kV / 3		
A3 / V-0		
		
Rated connection		
0.5...4 / 1.5...4		
0.5...4 / 0.5...2.5		
0.4...0.6 Nm (M 2.5)		
10 / 0.6 x 3.5 mm		
Tightening torque, N-isolator 0.4..0.6 Nm		

Type	Qty.	Order No.
WNT 2.5 10X3 BE	100	1010600000
WNT 2.5 10X3	100	1010680000
2.5 mm ² wires with wire ferrules including the plastic collar only clampable with diameter-optimised collar (Order no. 1333100000, pack of 500).		

Type	Width	Qty.	Order No.
WAP 2.5-10	1.5 mm	50	1050000000
WAP 2.5-10 BL	1.5 mm	50	1050080000
WHP 2.5-35N/10x3 BL	2 mm	20	1050280000
WEW 35/2	8 mm	100	1061200000
SWIFTY SET	18 mm	1	9006060000
SDS 0.6X3.5X100		1	9008330000
SSCH 10X3X1000 CU/SN	10 mm	1	0348900000
ZB 4	5.6 mm	50	0316500000
ZB 16 ZKSC	10 mm	50	0316600000
ZB 35/M6X16	14 mm	20	0266500000

Identification systems	
	(see assortment in catalogue 7)
	Marking tags
Note	

DEK 5/5 / WS 12/5

WNT 4

4 mm²

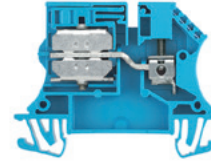

6.1 x 60 x 47	
41 / 6	NT
0.13...6	

IEC 60947-7-1

IEC	UL	CSA
400	600 (C)	600 (C)
32	35 (C)	25 (C)
4	AWG 22...10	AWG 26...10
6 kV / 3		
A4 / V-0		
		
Rated connection		
0.5...6 / 1.5...6		
0.5...6 / 0.5...4		
0.5...1 Nm (M 3)		
10 / 0.6 x 3.5 mm		
Tightening torque, N-isolator 0.4..0.8 Nm		

Type	Qty.	Order No.
WNT 4 10X3	100	1010780000

Type	Width	Qty.	Order No.
WAP 2.5-10	1.5 mm	50	1050000000
WAP 2.5-10 BL	1.5 mm	50	1050080000
WHP 2.5-35N/10x3 BL	2 mm	20	1050280000
WEW 35/2	8 mm	100	1061200000
SWIFTY SET	18 mm	1	9006060000
SDS 0.6X3.5X100		1	9008330000
SSCH 10X3X1000 CU/SN	10 mm	1	0348900000
ZB 4	5.6 mm	50	0316500000
ZB 16 ZKSC	10 mm	50	0316600000
ZB 35/M6X16	14 mm	20	0266500000

Identification systems	
	(see assortment in catalogue 7)
	Marking tags
Note	

DEK 5/5 / WS 12/5

WNT 6

6 mm²

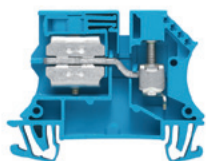

7.9 x 60 x 47
57 / 10
0.5...10

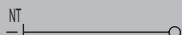

IEC 60947-7-1

IEC	UL	CSA
400	600 (C)	600 (C)
41	45 (C)	35 (C)
6	AWG 20...8	AWG 26...8
6 kV / 3		
A5 / V-0		



Rated connection

0.5...10 / 1.5...10
0.5...10 / 0.5...6
0.8...1.2 Nm (M 3.5)
12 / 4.0 x 0.8 mm

Tightening torque, N-isolator 0.8...1.6 Nm

Type	Qty.	Order No.
WNT 6 10X3	50	1010880000

Type	Width	Qty.	Order No.
WAP 2.5-10	1.5 mm	50	1050000000
WAP 2.5-10 BL	1.5 mm	50	1050080000
WHP 2.5-35N/10x3 BL	2 mm	20	1050280000
WEW 35/2	8 mm	100	1061200000
SWIFTY SET	18 mm	1	9006060000
SDS 0.6X3.5X100		1	9008330000
SSCH 10X3X1000 CU/SN	10 mm	1	0348900000
ZB 4	5.6 mm	50	0316500000
ZB 16 ZKSC	10 mm	50	0316600000
ZB 35/M6X16	14 mm	20	0266500000

DEK 5/5 / WS 12/5

WNT 10

10 mm²

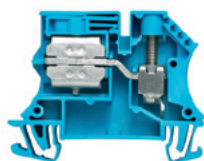

9.9 x 60 x 47
76 / 16
1.31...16

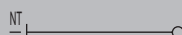

IEC 60947-7-1

IEC	UL	CSA
400	600 (C)	600 (C)
57	60 (C)	50 (C)
10	AWG 16...8	AWG 16...6
6 kV / 3		
B6 / V-0		



Rated connection

1.5...16 / 1.5...16
1.5...16 / 1.5...16
12...20 Nm (M 4)
12 / 1.0 x 5.5 mm

Tightening torque, N-isolator 0.8...1.6 Nm. AWG 6/7 and H07V-R25 conductors require a tightening torque of 1.5 Nm.

Type	Qty.	Order No.
WNT 10 10X3 BE	50	1010900000
WNT 10 10X3	50	1010980000

Type	Width	Qty.	Order No.
WAP 2.5-10	1.5 mm	50	1050000000
WAP 2.5-10 BL	1.5 mm	50	1050080000
WHP 2.5-35N/10x3 BL	2 mm	20	1050280000
WEW 35/2	8 mm	100	1061200000
SWIFTY SET	18 mm	1	9006060000
SDS 0.6X3.5X100		1	9008330000
SSCH 10X3X1000 CU/SN	10 mm	1	0348900000
ZB 4	5.6 mm	50	0316500000
ZB 16 ZKSC	10 mm	50	0316600000
ZB 35/M6X16	14 mm	20	0266500000

DEK 5/5 / WS 12/5

WNT 16N

16 mm²

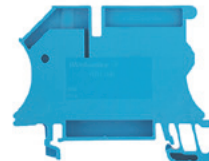

12 x 60 x 47
101 / 25
1.5...25

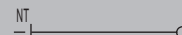

IEC 60947-7-1

IEC	UL	CSA
400	300 (C)	300 (C)
76	65 (C)	65 (C)
16	AWG 14...6	AWG 14...6
6 kV / 3		
B7 / V-0		



Rated connection

1.5...16 / 1.5...25
1.5...16 / 1.5...16
1.2...2.2 Nm (M 4)
12 / 1.0 x 5.5 mm

Tightening torque, N-isolator 0.8...1.6 Nm. AWG 6/7 and H07V-R25 conductors require a tightening torque of 1.5 Nm.

Type	Qty.	Order No.
WNT 16N 10X3	50	1019000000

Type	Width	Qty.	Order No.
WAP 2.5-10	1.5 mm	50	1050000000
WAP 2.5-10 BL	1.5 mm	50	1050080000
WHP 2.5-35N/10x3 BL	2 mm	20	1050280000
WEW 35/2	8 mm	100	1061200000
SWIFTY SET	18 mm	1	9006060000
SDS 0.6X3.5X100		1	9008330000
SSCH 10X3X1000 CU/SN	10 mm	1	0348900000
ZB 4	5.6 mm	50	0316500000
ZB 16 ZKSC	10 mm	50	0316600000
ZB 35/M6X16	14 mm	20	0266500000

DEK 5/5 / WS 12/5

Installation terminals

Neutral conductor disconnect terminals

These special modular terminals are specified for insulation measurements, without disconnecting the conductor according to VDE standards, for places of public assembly.

In hazardous area applications, the installation instructions and the rated data specifications for accessories given in the technical appendix must be followed.

Width/Length/Height of lowest version	mm
max. current / max. cond. cross-section	A/mm ²
Max. clamping range	mm ²



Technical data

Rated data	
Rated voltage	V
Rated current	A
Rated cross-section	mm ²
Rated impulse withstand voltage / Pollution severity Gauge to IEC 60947-1 / Flammability class UL94	
Approvals	
Clamped conductors (H05V/H07V)	
Solid / stranded	mm ²
Flexible / Flexible with ferrule	mm ²
Tightening torque range (terminal screw)	
Stripping length / Blade size	
mm/-	
Note	

Ordering data

Version	
	Dark beige Wemid
	Blue Wemid
Note	

Accessories

End plate / Partition plate	
	Dark beige Wemid
	Blue Wemid
Support bracket for 10 x 3 (required every 20 cm)	
	Blue Wemid
	
End bracket	
	Dark beige Wemid
Screwdriver	
	With "swifty set" cutting device
	Standard
Busbar 10 x 3 (140 A)	
	OK, Busbar up to OK, TS35 = 25,5 mm
Clamping yoke for power supply to 10 x 3 busbars	
	Rigid / flexible 0,5 - 6 / 4 mm ²
	Rigid / flexible 6 - 16 mm ²
	Flexible 16 - 35 mm ²
	

Identification systems	
	(see assortment in catalogue 7)
	Marking tags
Note	

WNT 35N

35 mm²

Compact design

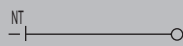

16 x 66 x 51	
150 / 50	NT 
2.5...50	

IEC 60947-7-1

IEC	UL	CSA
400		
125		
35		
		6 kV / 3
		B8 / V-0

Rated connection

2.5...16 / 2.5...50
2.5...35 / 2.5...35
4...5 Nm (M 6)
18 / 6.5 x 1.2 mm

The tightening torque for 16 - 50 mm² stranded conductors is 4.5 Nm. Tightening torque for N-isolator: 1.2...2.4 Nm.

Type	Qty.	Order No.
WNT 35N 10X3	20	1718550000

Type	Width	Qty.	Order No.
WAP 2.5-10	1.5 mm	50	1050000000
WAP 2.5-10 BL	1.5 mm	50	1050080000
WHP 2.5-35N/10x3 BL	2 mm	20	1050280000
WEW 35/2	8 mm	100	1061200000
SWIFTY SET	18 mm	1	9006060000
SDS 0.6X3.5X100		1	9008330000
SSCH 10X3X1000 CU/SN	10 mm	1	0348900000
ZB 4	5.6 mm	50	0316500000
ZB 16 ZKSC	10 mm	50	0316600000
ZB 35/M6X16	14 mm	20	0266500000

Identification systems	
	(see assortment in catalogue 7)
	Marking tags
Note	

DEK 5/5 / WS 12/5
Refer to the "W-Series Accessories" section for PEN bridges.

WNT 70N

70 mm²

Compact design

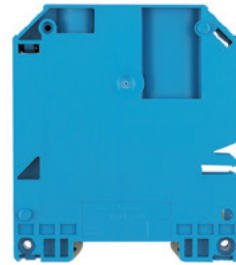

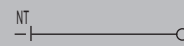
20.5 x 75 x 86	
207 / 95	NT 
10...95	

IEC 60947-7-1

IEC	UL	CSA
400	600 (C)	
192	175 (C)	
70	AWG 6...00	
		6 kV / 3
		B11 / V-0

Rated connection

10...16 / 10...95
10...70 / 10...70
60...12 Nm (M 8)
22 / S6 (DIN 6911)

Tightening torque, N-isolator 2.5..5.0 Nm.

Type	Qty.	Order No.
WNT 70N/35	10	9512210000

Type	Width	Qty.	Order No.
WAP 2.5-10	1.5 mm	50	1050000000
WAP 2.5-10 BL	1.5 mm	50	1050080000
WHP 2.5-35N/10x3 BL	2 mm	20	1050280000
WEW 35/2	8 mm	100	1061200000
SWIFTY SET	18 mm	1	9006060000
SDS 0.6X3.5X100		1	9008330000
SSCH 10X3X1000 CU/SN	10 mm	1	0348900000
ZB 4	5.6 mm	50	0316500000
ZB 16 ZKSC	10 mm	50	0316600000
ZB 35/M6X16	14 mm	20	0266500000

Identification systems	
	(see assortment in catalogue 7)
	Marking tags
Note	

DEK 5/5 / WS 12/5

Terminals with spring-loaded cable clamps

A spring below the clamping yoke ensures there is additional contact stability.

In hazardous area applications, the installation instructions and the rated data specifications for accessories given in the technical appendix must be followed.

Width/Length/Height of lowest version	mm
max. current / max. cond. cross-section	A/mm ²
Max. clamping range	mm ²

Technical data

Rated data	
Rated voltage	V
Rated current	A
Rated cross-section	mm ²
Rated impulse withstand voltage / Pollution severity Gauge to IEC 60947-1 / Flammability class UL94	
Approvals	
Clamped conductors (H05V/H07V)	
Solid / stranded	mm ²
Flexible / Flexible with ferrule	mm ²
Tightening torque range (terminal screw)	
Stripping length / Blade size	mm/-
2 conductors with same cross-section (H05V/H07V)	
Solid / stranded	mm ²
Flexible / Flexible with ferrule	mm ²
Note	

Ordering data

Version	
	Dark beige Wemid
	Dark beige Wemid (combi clip-on feet TS32/25)
	Black Wemid (combi clip-on feet TS32/25)
	Without STB
Note	

Accessories

Pluggable cross-connection	
	2-pole
	3-pole
	4-pole
	10-pole
	20-/24-pole
Screwable cross-connection	
	2-pole
	3-pole
	4-pole
	10-pole
End plate / Partition plate	
	Dark beige Wemid
	Black Wemid
	Dark beige Wemid
End bracket	
	Dark beige Wemid
Testing / Checking	
	Standard
Hak. Cable lugs	
Identification systems	
	(see assortment in catalogue 7)
	Marking tags
Note	

WDU 4 SL

4 mm²

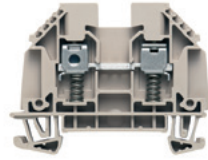

6.1 x 60 x 47
41 / 6
0.22...6

IEC 60947-7-1	Ex e II	Ex	II 2 G D
IEC	UL	CSA	EN 60079-7
500	600 (C)	300 (C)	275
32	30 (C)	25 (C)	28
4	AWG 22...10	AWG 22...10	4
6 kV / 3			
A4 / V-0			
SIRA 02ATEX3242 U			
Rated connection			
0.5...6 / 1.5...6			
0.5...4 / 0.5...4			
0.5...1 Nm (M 3)			
15 / 0.6 x 3.5 mm			
0.5...1.5			
0.5...1.5 / 0.5...1.5			
Note the max. current of the terminal (41 A) when using the cross-connector!			

Type	Qty.	Order No.
WDU 4 SL	50	9537440000

With pollution severity degree 2, the voltage can be raised to 630 V (no increased contamination can appear).

Type	current	Qty.	Order No.
ZQV 4N/2 GE	32 A	60	1758250000
ZQV 4N/3 GE	32 A	60	1762630000
ZQV 4N/4 GE	32 A	60	1762620000
ZQV 4N/10 GE	32 A	20	1758260000
ZQV 4N/20 GE	32 A	20	1909020000
Width			
WAP 2.5-10	1.5 mm	50	1050000000
WAP 2.5-10 SW	1.5 mm	50	1050010000
WAP 16+35 WTW 2.5-10	1.5 mm	20	1050100000
Width			
WEW 35/2	8 mm	100	1061200000
Width			
WTA 3 WDU4	6 mm	25	1632350000
HBT 1,5 - 3,0 RT		100	1312440000
HBT 2,5 - 3,0 BL		100	1312450000

WS 12/6

WDU 6 SL

6 mm²

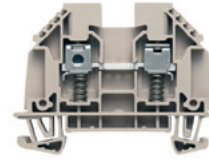

7.9 x 60 x 47
57 / 10
0.5...10

IEC 60947-7-1	Ex e II	Ex	II 2 G D
IEC	UL	CSA	EN 60079-7
500	150 (C)	300 (C)	275
41	50 (C)	45 (C)	36
6	AWG 20...8	AWG 20...8	6
6 kV / 3			
A5 / V-0			
SIRA 02ATEX3242 U			
Rated connection			
0.5...10 / 1.5...10			
0.5...6			
1 Nm (M 3.5)			
16 / 4.0 x 0.8 mm			
0.5			
ESI rated data: 500 V / 24 A / Note the max. current of the terminal (57 A) when using the cross-connector!			

Type	Qty.	Order No.
WDU 6 SL	50	9537460000

With pollution severity degree 2, the voltage can be raised to 630 V (no increased contamination can appear).

Type	current	Qty.	Order No.
WQV 6/2	57 A	50	1052360000
WQV 6/3	57 A	50	1054760000
WQV 6/4	57 A	50	1054860000
WQV 6/10	57 A	20	1052260000
Width			
WAP 2.5-10	1.5 mm	50	1050000000
WAP 2.5-10 SW	1.5 mm	50	1050010000
WAP 16+35 WTW 2.5-10	1.5 mm	20	1050100000
Width			
WEW 35/2	8 mm	100	1061200000
Width			
WTA 5/1	5 mm	25	1051260000
HBT 1,5 - 4,6 RT		100	1233340000
HBT 2,5 - 4,6 BL		100	1233330000
HBT 6,0 - 4,6 GE		100	1216230000

DEK 5/8 / WS 12/6,5

WDU 10 SL

10 mm²

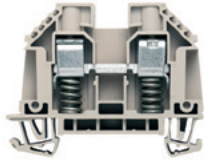

9.9 x 60 x 47
76 / 10
1.31...10

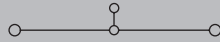

IEC 60947-7-1

Ex e II II 2 G D

IEC	UL	CSA	EN 60079-7
500	150 (C)	300 (C)	275
57	50 (C)	65 (C)	50
10	AWG 16...8	AWG 16...6	10

6 kV / 3
A5 / V-0



SIRA 02ATEX3242 U

Rated connection

1.5...10 / 1.5...10
1...6 / 1.5...10
1.2...2.4 Nm (M 4)
17 / 1.0 x 5.5 mm

1.5...4

2.5...4 / 1...4

ESI rated data: 500 V / 36 A / 16 mm² stranded connection must be tightened with 2 Nm.

Type	Qty.	Order No.
WDU 10 SL	50	9537480000
WDU 10 SL SW	50	9537400000

With pollution severity degree 2, the voltage can be raised to 630 V (no increased contamination can appear).

Type	current	Qty.	Order No.
WQV 10/2	57 A	50	1052560000
WQV 10/3	57 A	50	1054960000
WQV 10/4	57 A	50	1055060000
WQV 10/10	57 A	20	1052460000
Width			
WAP 2.5-10	1.5 mm	50	1050000000
WAP 2.5-10 SW	1.5 mm	50	1050010000
WAP 16+35 WTW 2.5-10	1.5 mm	20	1050100000
WEW 35/2	8 mm	100	1061200000
WTA 5/1	5 mm	25	1051260000
HBT 1.5 - 4.6 RT		100	1233340000
HBT 2.5 - 4.6 BL		100	1233330000
HBT 6.0 - 4.6 GE		100	1216230000

DEK 5/5 / WS 12/6,5

WTR 4 SL

4 mm²

With clamping screw

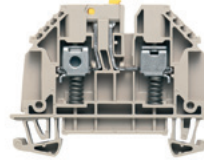

6.1 x 61.5 x 48.6
32 / 6
0.22...6



IEC 60947-7-1

IEC	UL	CSA
500	300 (C)	300 (D)
32	22 (C)	10 (D)
4	AWG 22...10	AWG 22...10

6 kV / 3
A4 / V-0



Rated connection

0.5...6 / 1.5...6
0.5...4 / 0.5...4
0.5...0.6 Nm (M 3)
13 / 0.6 x 3.5 mm

0.5...1.5

0.5...1.5 / 0.5...1.5

UL/CSA 600 V possible with end plate WAP or WTW partition plate.

Type	Qty.	Order No.
WTR 4 SL	50	7910270000

With pollution severity degree 2, the voltage can be raised to 630 V (no increased contamination can appear).

Type	current	Qty.	Order No.
ZQV 4N/2 GE	32 A	60	1758250000
ZQV 4N/3 GE	32 A	60	1762630000
ZQV 4N/4 GE	32 A	60	1762620000
ZQV 4N/10 GE	32 A	20	1758260000
ZQV 4N/20 GE	32 A	20	1909020000
Width			
WAP 2.5-10	1.5 mm	50	1050000000
WAP 2.5-10 SW	1.5 mm	50	1050010000
WAP 16+35 WTW 2.5-10	1.5 mm	20	1050100000
WEW 35/2	8 mm	100	1061200000
HBT 1.5 - 3.0 RT		100	1312440000
HBT 2.5 - 3.0 BL		100	1312450000

DEK 5/6 / WS 12/6

WTR 4 SL STB

4 mm²

With socket

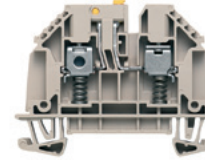

6.1 x 61.5 x 47
32 / 6
0.22...6

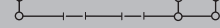

IEC 60947-7-1

IEC	UL	CSA
500	300 (C)	300 (D)
32	22 (C)	10 (D)
4	AWG 22...10	AWG 22...10

6 kV / 3
A4 / V-0



Rated connection

0.5...6 / 1.5...6
0.5...4 / 0.5...4
0.5...0.6 Nm (M 3)
13 / 0.6 x 3.5 mm

0.5...1.5

0.5...1.5 / 0.5...1.5

UL/CSA 600 V possible with end plate WAP or WTW partition plate.

Type	Qty.	Order No.
WTR 4 STB SL	50	7910300000

Type	current	Qty.	Order No.
ZQV 4N/2 GE	32 A	60	1758250000
ZQV 4N/3 GE	32 A	60	1762630000
ZQV 4N/4 GE	32 A	60	1762620000
ZQV 4N/10 GE	32 A	20	1758260000
ZQV 4N/20 GE	32 A	20	1909020000
Width			
WAP 2.5-10	1.5 mm	50	1050000000
WAP 2.5-10 SW	1.5 mm	50	1050010000
WAP 16+35 WTW 2.5-10	1.5 mm	20	1050100000
WEW 35/2	8 mm	100	1061200000
HBT 1.5 - 3.0 RT		100	1312440000
HBT 2.5 - 3.0 BL		100	1312450000

DEK 5/6 / WS 12/6

Terminals with spring-loaded cable clamps

A spring below the clamping yoke ensures there is additional contact stability.

In hazardous area applications, the installation instructions and the rated data specifications for accessories given in the technical appendix must be followed.

Width/Length/Height of lowest version	mm
max. current / max. cond. cross-section	A/mm ²
Max. clamping range	mm ²

Technical data

Rated data	
Rated voltage	V
Rated current	A
Rated cross-section	mm ²
Rated impulse withstand voltage / Pollution severity Gauge to IEC 60947-1 / Flammability class UL94	
Approvals	
Clamped conductors (H05V/H07V)	
Solid / stranded	mm ²
Flexible / Flexible with ferrule	mm ²
Tightening torque range (terminal screw)	
Stripping length / Blade size	mm/-
2 conductors with same cross-section (H05V/H07V)	
Solid / stranded	mm ²
Flexible / Flexible with ferrule	mm ²
Note	

Ordering data

Version	
	Dark beige Wemid
	Dark beige Wemid (combi clip-on feet TS32/25)
	Black Wemid (combi clip-on feet TS32/25)
	Without STB
Note	

Accessories

Pluggable cross-connection	
	2-pole
	3-pole
	4-pole
	10-pole
	20-/24-pole
Screwable cross-connection	
	2-pole
	3-pole
	4-pole
	10-pole
End plate / Partition plate	
	Dark beige Wemid
	Black Wemid
	Dark beige Wemid
End bracket	
	Dark beige Wemid
Testing / Checking	
	Standard
Hak. Cable lugs	
Identification systems	
	(see assortment in catalogue 7)
	Marking tags
Note	

WDU 4 SL/EN

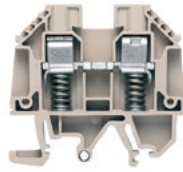
4 mm²

6.1 x 60 x 53.5
41 / 6
0.22...6

IEC 60947-7-1 Ex e II II 2 G D

IEC	UL	CSA	EN 60079-7
500	600 (C)	300 (C)	275
32	30 (C)	25 (C)	28
4	AWG 22...10	AWG 22...10	4
6 kV / 3			
A4 / V-0			
SIRA 02ATEX3242 U			
Rated connection			
0.5...6 / 1.5...6			
0.5...4 / 0.5...4			
0.5...1 Nm (M 3)			
15 / 0.6 x 3.5 mm			
0.5...1.5			
0.5...1.5 / 0.5...1.5			
Note Note the max. current of the terminal (41 A) when using the cross-connector!			

Type	Qty.	Order No.
WDU 4 SL/EN	50	9537450000
WDU 4 SL/EN SW	50	9537510000
Note With pollution severity degree 2, the voltage can be raised to 630 V (no increased contamination can appear).		

Type	current	Qty.	Order No.
ZQV 4N/2 GE	32 A	60	1758250000
ZQV 4N/3 GE	32 A	60	1762630000
ZQV 4N/4 GE	32 A	60	1762620000
ZQV 4N/10 GE	32 A	20	1758260000
ZQV 4N/20 GE	32 A	20	1909020000
Width			
WAP 2.5-10	1.5 mm	50	1050000000
WAP 2.5-10 SW	1.5 mm	50	1050010000
WAP 16+35 WTW 2.5-10	1.5 mm	20	1050100000
WEW 35/2	8 mm	100	1061200000
WTA 3 WDU4	6 mm	25	1632350000
HBT 1,5 - 3,0 RT		100	1312440000
HBT 2,5 - 3,0 BL		100	1312450000

WS 12/6

WDU 6 SL/EN

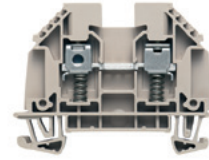
6 mm²

7.9 x 60 x 53.5
57 / 10
0.5...10

IEC 60947-7-1 Ex e II II 2 G D

IEC	UL	CSA	EN 60079-7
500	150 (C)	300 (C)	275
41	50 (C)	45 (C)	36
6	AWG 20...8	AWG 20...8	6
6 kV / 3			
A5 / V-0			
SIRA 02ATEX3242 U			
Rated connection			
0.5...10 / 1.5...10			
0.5...6			
1 Nm (M 3.5)			
16 / 4.0 x 0.8 mm			
0.5			
Note ESI rated data: 500 V / 24 A / Note the max. current of the terminal (57 A) when using the cross-connector!			

Type	Qty.	Order No.
WDU 6 SL/EN	50	9537470000
WDU 6 SL/EN SW	50	9537430000
Note With pollution severity degree 2, the voltage can be raised to 630 V (no increased contamination can appear).		

Type	current	Qty.	Order No.
WQV 6/2	57 A	50	1052360000
WQV 6/3	57 A	50	1054760000
WQV 6/4	57 A	50	1054860000
WQV 6/10	57 A	20	1052260000
Width			
WAP 2.5-10	1.5 mm	50	1050000000
WAP 2.5-10 SW	1.5 mm	50	1050010000
WAP 16+35 WTW 2.5-10	1.5 mm	20	1050100000
WEW 35/2	8 mm	100	1061200000
WTA 5/1	5 mm	25	1051260000
HBT 1,5 - 4,6 RT		100	1233340000
HBT 2,5 - 4,6 BL		100	1233330000
HBT 6,0 - 4,6 GE		100	1216230000

DEK 5/8 / WS 12/6,5

WDU 10 SL/EN

10 mm²

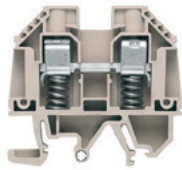

9.9 x 56.6 x 53.5
76 / 16
1.31...16

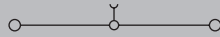

IEC 60947-7-1

Ex e II II 2 G D

IEC	UL	CSA	EN 60079-7
500	600 (C)	300 (C)	275
57	50 (C)	65 (C)	50
10	AWG 16...8	AWG 16...6	10

6 kV / 3
A6 / V-0

SIRA 02ATEX3242 U

Rated connection

1.5...16 / 1.5...16
1...6 / 1.5...10
1.2...2.4 Nm (M 4)
17 / 1.0 x 5.5 mm

1.5...4
2.5...4 / 1...4

ESI rated data: 500 V / 36 A / 16 mm² stranded connection must be tightened with 2 Nm.

Type	Qty.	Order No.
WDU 10 SL/EN	50	9537490000
WDU 10 SL/EN SW	50	9537410000

With pollution severity degree 2, the voltage can be raised to 630 V (no increased contamination can appear).

Type	current	Qty.	Order No.
WQV 10/2	57 A	50	1052560000
WQV 10/3	57 A	50	1054960000
WQV 10/4	57 A	50	1055060000
WQV 10/10	57 A	20	1052460000
Width			
WAP 2.5-10	1.5 mm	50	1050000000
WAP 2.5-10 SW	1.5 mm	50	1050010000
WAP 16+35 WTW 2.5-10	1.5 mm	20	1050100000
WEW 35/2	8 mm	100	1061200000
WTA 5/1	5 mm	25	1051260000
HBT 1.5 - 4.6 RT		100	1233340000
HBT 2.5 - 4.6 BL		100	1233330000
HBT 6.0 - 4.6 GE		100	1216230000

DEK 5/5 / WS 12/6,5

WTR 4 SL/EN

4 mm²

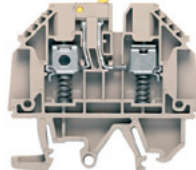

6.1 x 61.5 x 55
32 / 6
0.22...6



IEC 60947-7-1

IEC	UL	CSA
500	300 (C)	300 (D)
32	22 (C)	10 (D)
4	AWG 22...10	AWG 22...10

6 kV / 3
A4 / V-0

Rated connection

0.5...6 / 1.5...6
0.5...4 / 0.5...4
0.5...0.6 Nm (M 3)
13 / 0.6 x 3.5 mm

0.5...1.5
0.5...1.5 / 0.5...1.5

UL/CSA 600 V possible with end plate WAP or WTW partition plate.

Type	Qty.	Order No.
WTR4 SL/EN	50	7910360000
WTR4 SL/EN SW	50	7910380000

With pollution severity degree 2, the voltage can be raised to 630 V (no increased contamination can appear).

Type	current	Qty.	Order No.
ZQV 4N/2 GE	32 A	60	1758250000
ZQV 4N/3 GE	32 A	60	1762630000
ZQV 4N/4 GE	32 A	60	1762620000
ZQV 4N/10 GE	32 A	20	1758260000
ZQV 4N/20 GE	32 A	20	1909020000
Width			
WAP 2.5-10	1.5 mm	50	1050000000
WAP 2.5-10 SW	1.5 mm	50	1050010000
WAP 16+35 WTW 2.5-10	1.5 mm	20	1050100000
WEW 35/2	8 mm	100	1061200000
HBT 1.5 - 3.0 RT		100	1312440000
HBT 2.5 - 3.0 BL		100	1312450000

DEK 5/6 / WS 12/6

WTR 4 STB SL/EN

4 mm²

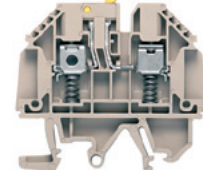

6.1 x 61.5 x 55
32 / 6
0.22...6

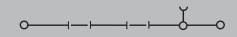

IEC 60947-7-1

IEC	UL	CSA
500	300 (C)	300 (D)
32	22 (C)	10 (D)
4	AWG 22...10	AWG 22...10

6 kV / 3
A4 / V-0

Rated connection

0.5...6 / 1.5...6
0.5...4 / 0.5...4
0.5...0.6 Nm (M 3)
13 / 0.6 x 3.5 mm

0.5...1.5
0.5...1.5 / 0.5...1.5

UL/CSA 600 V possible with end plate WAP or WTW partition plate.

Type	Qty.	Order No.
WTR4 SL/EN STB	50	7910390000

Type	current	Qty.	Order No.
ZQV 4N/2 GE	32 A	60	1758250000
ZQV 4N/3 GE	32 A	60	1762630000
ZQV 4N/4 GE	32 A	60	1762620000
ZQV 4N/10 GE	32 A	20	1758260000
ZQV 4N/20 GE	32 A	20	1909020000
Width			
WAP 2.5-10	1.5 mm	50	1050000000
WAP 2.5-10 SW	1.5 mm	50	1050010000
WAP 16+35 WTW 2.5-10	1.5 mm	20	1050100000
WEW 35/2	8 mm	100	1061200000
HBT 1.5 - 3.0 RT		100	1312440000
HBT 2.5 - 3.0 BL		100	1312450000

DEK 5/6 / WS 12/6

Terminals with spring-loaded cable clamps

A spring below the clamping yoke ensures there is additional contact stability.

In hazardous area applications, the installation instructions and the rated data specifications for accessories given in the technical appendix must be followed.

Width/Length/Height of lowest version	mm
max. current / max. cond. cross-section	A/mm ²
Max. clamping range	mm ²

Technical data

Rated data	
Rated voltage	V
Rated current	A
Rated cross-section	mm ²
Rated impulse withstand voltage / Pollution severity Gauge to IEC 60947-1 / Flammability class UL94	
Approvals	
Clamped conductors (H05V/H07V)	
Solid / stranded	mm ²
Flexible / Flexible with ferrule	mm ²
Tightening torque range (terminal screw)	
Stripping length / Blade size	mm/-
2 conductors with same cross-section (H05V/H07V)	
Solid / stranded	mm ²
Flexible / Flexible with ferrule	mm ²
Note	

Ordering data

Version	
	Dark beige Wemid
	Dark beige Wemid (combi clip-on feet TS32/25)
	Black Wemid (combi clip-on feet TS32/25)
	Without STB
Note	

Accessories

Pluggable cross-connection	
	2-pole
	3-pole
	4-pole
	10-pole
	20-/24-pole
Screwable cross-connection	
	2-pole
	3-pole
	4-pole
	10-pole
End plate / Partition plate	
	Dark beige Wemid
	Black Wemid
	Dark beige Wemid
End bracket	
	Dark beige Wemid
Testing / Checking	
	Standard
Hak. Cable lugs	
Identification systems	
	(see assortment in catalogue 7)
	Marking tags
Note	

WTR 4 SI SL

4 mm²

With fuse holder

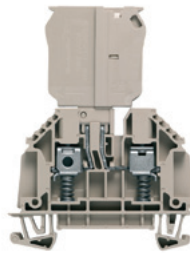

6.1 x 61.5 x 97.5
6.3 / 6
0.22...6

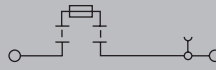

IEC 60947-7-1

IEC	UL	CSA
400	300 (C)	300 (D)
6.3	6.3 (C)	6.3 (D)
4	AWG 22...10	AWG 22...10
6 kV / 3		
A4 / V-0		

UL, CE, RoHS, REACH

Rated connection	
Solid / stranded	0.5...6 / 1.5...6
Flexible / Flexible with ferrule	0.5...4 / 0.5...4
Tightening torque range (M 3)	
Stripping length / Blade size	13 / 0.6 x 3.5 mm
2 conductors with same cross-section (H05V/H07V)	
Solid / stranded	0.5...1.5
Flexible / Flexible with ferrule	0.5...1.5 / 0.5...1.5
Note	

Type	Qty.	Order No.
WTR 4 SI SL	25	7910330000
Note		

Type	current	Qty.	Order No.
ZQV 4N/2 GE	32 A	60	1758250000
ZQV 4N/3 GE	32 A	60	1762630000
ZQV 4N/4 GE	32 A	60	1762620000
ZQV 4N/10 GE	32 A	20	1758260000
ZQV 4N/20 GE	32 A	20	1909020000
Width			
WAP 2.5-10	1.5 mm	50	1050000000
WAP 2.5-10 SW	1.5 mm	50	1050010000
WAP 16+35 WTW 2.5-10	1.5 mm	20	1050100000
Width			
WEW 35/2	8 mm	100	1061200000
HBT 1,5 - 3,0 RT		100	1312440000
HBT 2,5 - 3,0 BL		100	1312450000
Width			
DEK 5/6 / WS 12/6			
Note			

WTL 6 SL

6 mm²

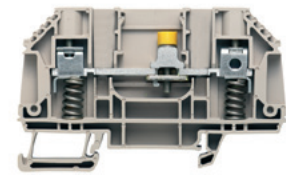

7.9 x 82.7 x 50.5
57 / 10
0.5...10

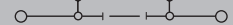

IEC 60947-7-1

IEC	UL	CSA
500		
6		
/ 3		
A5 / V-0		

Rated connection	
Solid / stranded	0.5...10 / 1.5...10
Flexible / Flexible with ferrule	0.5...6
Tightening torque range (M 3.5)	
Stripping length / Blade size	16 / 4.0 x 0.8 mm
Note	

Rated data ES: 500 V / 24 A.

Type	Qty.	Order No.
WTL 6 SL	50	1161690000
WTL 6 SL 0.STB	600	1238930000
Note		

With pollution severity degree 2, the voltage can be raised to 630 V (no increased contamination can appear).

Type	current	Qty.	Order No.
WQV 6/2	57 A	50	1052360000
WQV 6/3	57 A	50	1054760000
WQV 6/4	57 A	50	1054860000
WQV 6/10	57 A	20	1052260000
Width			
WAP WTL6 SL 4-6	1.5 mm	20	1238880000
WAP WTL6 SL	1.5 mm	20	9538110000
WTW EN	3 mm	20	1058800000
Width			
WEW 35/2	8 mm	100	1061200000
HBT 1,5 - 4,6 RT		100	1233340000
HBT 2,5 - 4,6 BL		100	1233330000
HBT 6,0 - 4,6 GE		100	1216230000
Width			
WS 12/6,5			
Note			

WTD 6 SL

6 mm²

Feed-through

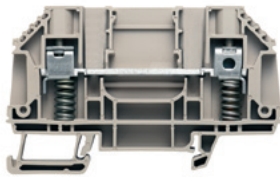

7.9 x 82.7 x 50.5
57 / 10
0.5...10



IEC 60947-7-1

IEC	UL	CSA
500		
41		
6		
6 kV / 3 A5 / V-0		

Rated connection

0.5...10 / 1.5...10
0.5...6
1 Nm(M 3.5)
16 / 4.0 x 0.8 mm

0.5

Rated data ESI: 500 V / 24 A.

Type	Qty.	Order No.
WTD 6 SL	50	9538090000
WTD 6 SL 0.STB	600	1238920000

Type	current	Qty.	Order No.
WQV 6/2	57 A	50	1052360000
WQV 6/3	57 A	50	1054760000
WQV 6/4	57 A	50	1054860000
WQV 6/10	57 A	20	1052260000
Width			
WAP WTL6 SL 4-6	1.5 mm	20	1238880000
WAP WTL6 SL	1.5 mm	20	9538110000
WTW EN	3 mm	20	1058800000
WEW 35/2	8 mm	100	1061200000
HBT 1,5 - 4,6 RT		100	1233340000
HBT 2,5 - 4,6 BL		100	1233330000
HBT 6,0 - 4,6 GE		100	1216230000

WS 12/6,5

WTL 6 SL/EN

6 mm²

Longitudinal - disconnecter

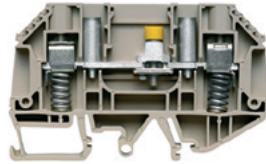

7.9 x 82.7 x 51.5
57 / 10
0.5...10

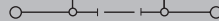

IEC 60947-7-1

IEC	UL	CSA
500		
41		
6		
6 kV / 3 A5 / V-0		

Rated connection

0.5...10 / 1.5...10
0.5...6
1 Nm(M 3.5)
16 / 4.0 x 0.8 mm

0.5

Rated data ESI: 500 V / 24 A.

Type	Qty.	Order No.
WTL 6 SL/EN	50	9538080000

With pollution severity degree 2, the voltage can be raised to 630 V (no increased contamination can appear).

Type	current	Qty.	Order No.
WQV 6/2	57 A	50	1052360000
WQV 6/3	57 A	50	1054760000
WQV 6/4	57 A	50	1054860000
WQV 6/10	57 A	20	1052260000
Width			
WAP WTL6 SL 4-6	1.5 mm	20	1238880000
WAP WTL6 SL	1.5 mm	20	9538110000
WTW EN	3 mm	20	1058800000
WEW 35/2	8 mm	100	1061200000
HBT 1,5 - 4,6 RT		100	1233340000
HBT 2,5 - 4,6 BL		100	1233330000
HBT 6,0 - 4,6 GE		100	1216230000

WS 12/6,5

WTD 6 SL/EN

6 mm²

Feed-through

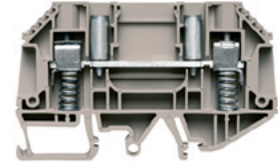

7.9 x 82.7 x 51.5
57 / 10
0.5...10



IEC 60947-7-1

IEC	UL	CSA
500		
41		
6		
6 kV / 3 A5 / V-0		

Rated connection

0.5...10 / 1.5...10
0.5...6
1 Nm(M 3.5)
16 / 4.0 x 0.8 mm

0.5

Rated data ESI: 500 V / 24 A.

Type	Qty.	Order No.
WTD 6 SL/EN	50	9538100000

Type	current	Qty.	Order No.
WQV 6/2	57 A	50	1052360000
WQV 6/3	57 A	50	1054760000
WQV 6/4	57 A	50	1054860000
WQV 6/10	57 A	20	1052260000
Width			
WAP WTL6 SL 4-6	1.5 mm	20	1238880000
WAP WTL6 SL	1.5 mm	20	9538110000
WTW EN	3 mm	20	1058800000
WEW 35/2	8 mm	100	1061200000
HBT 1,5 - 4,6 RT		100	1233340000
HBT 2,5 - 4,6 BL		100	1233330000
HBT 6,0 - 4,6 GE		100	1216230000

WS 12/6,5

Initiator and actuator terminals

Time- and space-saving wiring for initiators and actuators. All the connections for initiator and actuator are in one terminal.

In hazardous area applications, the installation instructions and the rated data specifications for accessories given in the technical appendix must be followed.

Width/Length/Height of lowest version	mm
max. current / max. cond. cross-section	A/mm ²
Max. clamping range	mm ²

Technical data

Rated data	
Rated voltage	V
Rated current	A
Rated cross-section	mm ²
Rated impulse withstand voltage / Pollution severity	
Gauge to IEC 60947-1 / Flammability class UL94	
Approvals	
Electronic fixtures	
Component voltage / Component current	V/A
Operating voltage for display, max. / Current	V/A
Clamped conductors (H05V/H07V)	
Solid / stranded	mm ²
Flexible / Flexible with ferrule	mm ²
Tightening torque range (terminal screw)	
Stripping length / Blade size	mm/-
Note	

Ordering data

Version	
	Dark beige Wemid
	Dark beige Wemid (red LED)
	Dark beige Wemid (green LED)
Note	

Accessories

Screwable cross-connection	
	2-pole
	3-pole
	4-pole
	10-pole
End plate / Partition plate	
	Dark beige Wemid
End bracket	
	Dark beige Wemid
Screwdriver	
	Standard
Small partition	
	Small partition

Identification systems	
	(see assortment in catalogue 7)
	Marking tags
Note	

DLD 2.5

2.5 mm²

Voltage supply

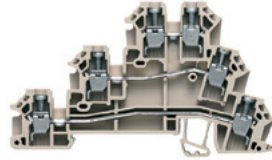

6.1 x 82.5 x 49
24 / 4
0.13...4

IEC 60947-7-1

IEC	UL	CSA
250	300 (D)	300 (C)
24	10 (D)	10 (C)
2.5	AWG 22...12	AWG 26...12
4 kV / 3		
A3 / V-0		



Rated connection

0.5...4 / 1.5...4
0.5...4 / 0.5...2.5
0.4...0.6 Nm (M 2.5)
7 / 0.6 x 3.5 mm

Rated voltage is reduced to 30 V AC when one pole with a different potential is skipped with a cross-connector.

Type	Qty.	Order No.
DLD 2.5 DB	50	1784180000
Variant in blue, Order no. 6269250000 (qty. 50)		

Type	current	Qty.	Order No.
Q 2 DLI	20 A	50	1312500000
Q 3 DLI	20 A	50	1312600000
Q 4 DLI	20 A	50	1312700000
Q 10 DLI	20 A	20	1313100000
Width			
AP DLI2.5 DB	1.5 mm	20	1783550000
EW 35	8.5 mm	50	0383560000
SDS 0.6X3.5X100		1	9008330000
TSCH 1	2 mm	100	0319160000

DEK 5/6
TEAP DLD2.5 DB partial end plate, Order no. 1784220000 (20 pcs.)

DLD 2.5 PE

2.5 mm²

Lower level earthed

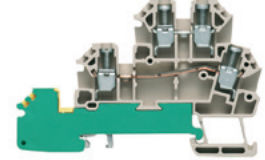

6.1 x 74.5 x 49
17.5 / 4
0.13...4

IEC 60947-7-1

IEC	UL	CSA
250	300 (D)	300 (D)
17.5	10 (D)	10 (D)
2.5	AWG 22...12	AWG 26...12
4 kV / 3		
A3 / V-0		



Rated connection

0.5...4 / 0.5...4
0.5...4 / 0.5...2.5
0.4...0.6 Nm (M 2.5)
7 / 0.6 x 3.5 mm

Rated voltage is reduced to 30 V AC when one pole with a different potential is skipped with a cross-connector.

Type	Qty.	Order No.
DLD 2.5/PE DB	50	1783790000

Type	current	Qty.	Order No.
Q 2 DLI	20 A	50	1312500000
Q 3 DLI	20 A	50	1312600000
Q 4 DLI	20 A	50	1312700000
Q 10 DLI	20 A	20	1313100000
Width			
AP DLI2.5 DB	1.5 mm	20	1783550000
EW 35	8.5 mm	50	0383560000
SDS 0.6X3.5X100		1	9008330000
TSCH 1	2 mm	100	0319160000

DEK 5/6
TEAP DLD2.5/PE DB partial end plate, Order no. 1783810000 (20 pcs.)

DLI 2.5

2.5 mm²

Initiator connection (signal,+,-)

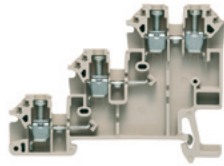

6.1 x 66 x 49
26 / 4
0.13...4

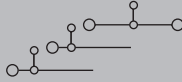

IEC 60947-7-1

IEC	UL	CSA
250	300 (D)	300 (C)
24	10 (D)	10 (C)
2.5	AWG 22...12	AWG 26...12
4 kV / 3		
A3 / V-0		



Rated connection

0.5...4 / 1.5...4
0.5...4 / 0.5...2.5
0.4...0.6 Nm (M 2.5)
7 / 0.6 x 3.5 mm

Rated voltage is reduced to 30 V AC when one pole with a different potential is skipped.

Type	Qty.	Order No.
DLI 2.5 DB	100	1783820000

Type	current	Qty.	Order No.
Q 2 DLI	20 A	50	1312500000
Q 3 DLI	20 A	50	1312600000
Q 4 DLI	20 A	50	1312700000
Q 10 DLI	20 A	20	1313100000
Width			
AP DLI2.5 DB	1.5 mm	20	1783550000
EW 35	8.5 mm	50	0383560000
SDS 0.6X3.5X100		1	9008330000
TSCH 1	2 mm	100	0319160000

DEK 5/6

StB 8.5 socket in upper busbar (together with PS 2.3 test plug)

DLI 2.5 LD PNP

2.5 mm²

Initiator connection with LED

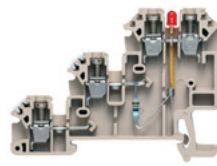

6.1 x 66 x 49
24 / 4
0.13...4

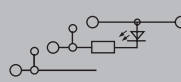

IEC 60947-7-1

IEC	UL	CSA
30	30 (C)	30 (C)
24	10 (C)	10 (C)
2.5	AWG 22...12	AWG 26...12
0.8 kV / 3		
A3 / V-0		



30 / 5

Rated connection

0.5...4 / 1.5...4
0.5...4 / 0.5...2.5
0.4...0.6 Nm (M 2.5)
7 / 0.6 x 3.5 mm

Type	Qty.	Order No.
DLI 2.5/LD-RT/PNP +- DB	100	1783980000
DLI 2.5/LD-GN/PNP +- DB	100	1783970000

Type	current	Qty.	Order No.
Q 2 DLI	20 A	50	1312500000
Q 3 DLI	20 A	50	1312600000
Q 4 DLI	20 A	50	1312700000
Q 10 DLI	20 A	20	1313100000
Width			
AP DLI2.5 DB	1.5 mm	20	1783550000
EW 35	8.5 mm	50	0383560000
SDS 0.6X3.5X100		1	9008330000
TSCH 1	2 mm	100	0319160000

DEK 5/6

DLI 2.5 LD NPN

2.5 mm²

Initiator connection with LED

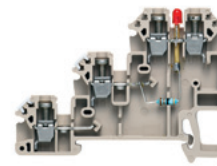

6.1 x 66 x 49
24 / 4
0.13...4

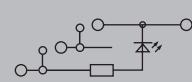

IEC 60947-7-1

IEC	UL	CSA
30	30 (C)	30 (C)
24	10 (C)	10 (C)
2.5	AWG 22...12	AWG 26...12
0.8 kV / 3		
A3 / V-0		



30 / 5

Rated connection

0.5...4 / 1.5...4
0.5...4 / 0.5...2.5
0.4...0.6 Nm (M 2.5)
7 / 0.6 x 3.5 mm

Type	Qty.	Order No.
DLI 2.5/LD-RT/NPN +- DB	100	1783950000
DLI 2.5/LD-GN/NPN +- DB	100	1783940000

Type	current	Qty.	Order No.
Q 2 DLI	20 A	50	1312500000
Q 3 DLI	20 A	50	1312600000
Q 4 DLI	20 A	50	1312700000
Q 10 DLI	20 A	20	1313100000
Width			
AP DLI2.5 DB	1.5 mm	20	1783550000
EW 35	8.5 mm	50	0383560000
SDS 0.6X3.5X100		1	9008330000
TSCH 1	2 mm	100	0319160000

DEK 5/6

Initiator and actuator terminals

Time- and space-saving wiring for initiators and actuators. All the connections for initiator and actuator are in one terminal.

In hazardous area applications, the installation instructions and the rated data specifications for accessories given in the technical appendix must be followed.

Width/Length/Height of lowest version	mm
max. current / max. cond. cross-section	A/mm ²
Max. clamping range	mm ²

Technical data

Rated data	
Rated voltage	V
Rated current	A
Rated cross-section	mm ²
Rated impulse withstand voltage / Pollution severity	
Gauge to IEC 60947-1 / Flammability class UL94	
Approvals	
Electronic fixtures	
Component voltage / Component current	V/A
Operating voltage for display, max. / Current	V/A
Clamped conductors (H05V/H07V)	
Solid / stranded	mm ²
Flexible / Flexible with ferrule	mm ²
Tightening torque range (terminal screw)	
Stripping length / Blade size	mm/-
Note	

Ordering data

Version	
	Dark beige Wemid
	Dark beige Wemid (red LED)
	Dark beige Wemid (green LED)
Note	

Accessories

Screwable cross-connection	
	2-pole
	3-pole
	4-pole
	10-pole
End plate / Partition plate	
	Dark beige Wemid
End bracket	
	Dark beige Wemid
Screwdriver	
	Standard
Small partition	
	Small partition

Identification systems	
	(see assortment in catalogue 7)
	Marking tags
Note	

DLA 2.5

2.5 mm²

Actuator connection (signal,-PE)

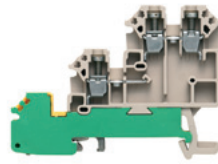

6.1 x 65 x 49
26 / 4
0.13...4



IEC 60947-7-1 (-7-2)

IEC	UL	CSA
250	300 (D)	300 (D)
17.5	10 (D)	10 (D)
2.5	AWG 22...12	AWG 26...12
4 kV / 3		
A3 / V-0		



Rated connection

0.5...4 / 1.5...4
0.5...4 / 0.5...2.5
0.4...0.6 Nm (M 2.5)
7 / 0.6 x 3.5 mm

Rated voltage is reduced to 30 V AC when one pole with a different potential is skipped with a cross-connector.

Type	Qty.	Order No.
DLA 2.5 DB	100	1783560000

Type	current	Qty.	Order No.
Q 2 DLI	20 A	50	1312500000
Q 3 DLI	20 A	50	1312600000
Q 4 DLI	20 A	50	1312700000
Q 10 DLI	20 A	20	1313100000
Width			
AP DLI2.5 DB	1.5 mm	20	1783550000
EW 35	8.5 mm	50	0383560000
SDS 0.6X3.5X100		1	9008330000
TSCH 1	2 mm	100	0319160000

DEK 5/6

DLA 2.5/D

2.5 mm²

Actuator connection (circuit with diode)

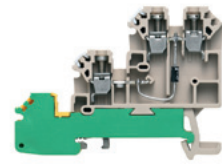

6.1 x 66 x 49
17.5 / 4
0.13...4

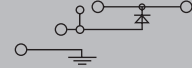

IEC 60947-7-1 (-7-2)

IEC	UL	CSA
250	300 (D)	300 (D)
17.5	10 (D)	10 (D)
2.5	AWG 22...12	AWG 26...12
4 kV / 3		
A3 / V-0		



Rated connection

0.5...4 / 1.5...4
0.5...4 / 0.5...2.5
0.4...0.6 Nm (M 2.5)
7 / 0.6 x 3.5 mm

Rated voltage is reduced to 30 V AC when one pole with a different potential is skipped with a cross-connector.

Type	Qty.	Order No.
DLA 2.5/D DB	100	1783590000

Type	current	Qty.	Order No.
Q 2 DLI	20 A	50	1312500000
Q 3 DLI	20 A	50	1312600000
Q 4 DLI	20 A	50	1312700000
Q 10 DLI	20 A	20	1313100000
Width			
AP DLI2.5 DB	1.5 mm	20	1783550000
EW 35	8.5 mm	50	0383560000
SDS 0.6X3.5X100		1	9008330000
TSCH 1	2 mm	100	0319160000

DEK 5/6

DLA 2.5/LD

2.5 mm²

Actuator connection with LED

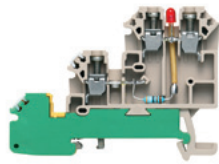

6.1 x 66 x 49
17.5 / 4
0.13...4

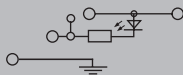

IEC 60947-7-1 (-7-2)

IEC	UL	CSA
30	30 (C)	30 (C)
17.5	10 (C)	10 (C)
2.5	AWG 22...12	AWG 26...12
0.8 kV / 3		
A3 / V-0		



30 / 5

Rated connection

0.5...4 / 1.5...4
 0.5...4 / 0.5...2.5
 0.4...0.6 Nm (M 2.5)
 7 / 0.6 x 3.5 mm

Type	Qty.	Order No.
DLA 2.5/LD-RT DB	100	1783600000

Type	current	Qty.	Order No.
Q 2 DLI	20 A	50	1312500000
Q 3 DLI	20 A	50	1312600000
Q 4 DLI	20 A	50	1312700000
Q 10 DLI	20 A	20	1313100000
Width			
AP DLI2.5 DB	1.5 mm	20	1783550000
EW 35	8.5 mm	50	0383560000
SDS 0.6X3.5X100		1	9008330000
TSCH 1	2 mm	100	0319160000

DEK 5/6

DLA 2.5/LD/D

2.5 mm²

Actuator connection with LED

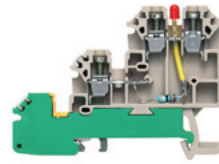

6.1 x 66 x 49
17.5 / 4
0.13...4

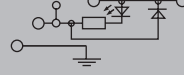

IEC 60947-7-1 (-7-2)

IEC	UL	CSA
30	30 (C)	30 (C)
	10 (C)	10 (C)
2.5	AWG 22...12	AWG 26...12
0.8 kV / 3		
A3 / V-0		



1000 / 1

30 / 5

Rated connection

0.5...4 / 1.5...4
 0.5...4 / 0.5...2.5
 0.4...0.6 Nm (M 2.5)
 7 / 0.6 x 3.5 mm

Type	Qty.	Order No.
DLA 2.5/LD-GN/D DB	100	1783630000

Type	current	Qty.	Order No.
Q 2 DLI	20 A	50	1312500000
Q 3 DLI	20 A	50	1312600000
Q 4 DLI	20 A	50	1312700000
Q 10 DLI	20 A	20	1313100000
Width			
AP DLI2.5 DB	1.5 mm	20	1783550000
EW 35	8.5 mm	50	0383560000
SDS 0.6X3.5X100		1	9008330000
TSCH 1	2 mm	100	0319160000

DEK 5/6

Motor connection terminals

In hazardous area applications, the installation instructions and the rated data specifications for accessories given in the technical appendix must be followed.

Width/Length/Height of lowest version	mm
max. current / max. cond. cross-section	A/mm ²
Max. clamping range	mm ²

Technical data

Rated data	
Rated voltage	V
Rated current	A
Rated cross-section	mm ²
Rated impulse withstand voltage / Pollution severity	
Gauge to IEC 60947-1 / Flammability class UL94	
Approvals	
Clamped conductors (H05V/H07V)	
Solid / stranded	mm ²
Flexible / Flexible with ferrule	mm ²
Tightening torque range (terminal screw)	
Stripping length / Blade size	mm/-
Note	

Ordering data

Version	Dark beige Wemid With PE foot
Note	

Accessories

End plate / Partition plate	Dark beige PA
End bracket	Dark beige Wemid
Screwdriver	Standard
Cross-connection	black blue red

Identification systems	(see assortment in catalogue 7) Marking tags
Note	

MAK 2.5

2.5 mm²

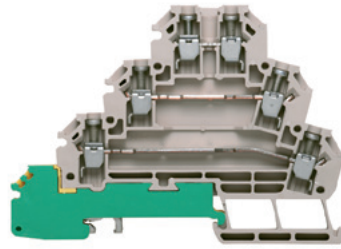

6.2 x 88 x 64	
31 / 4	
0.13...4	

IEC	UL	CSA
500	300 (D)	300 (C)
24	10 (D)	10 (C)
2.5	AWG 22...12	AWG 26...12
6 kV / 3		
A3 / V-0		
® 94		
Rated connection		
0.5...4 / 0.5...4		
0.5...4 / 0.5...2.5		
0.4...0.6 Nm (M 2.5)		
8 / 0.6 x 3.5 mm		

Type	Qty.	Order No.
MAK 2.5 DB	50	7917030000

Type	Width	Qty.	Order No.
AP MAK2.5 DB	1.5 mm	20	7917000000
WEW 35/1	12 mm	50	1059000000
SDIS 0.6X3.5X100		1	9008390000
current			
VQB 1.5/50 SW	17.5 A	5	1635120000
VQB 1.5/50 BL	17.5 A	5	1633280000
VQB 1.5/50 RT	17.5 A	5	1633290000

Identification systems	(see assortment in catalogue 7) Marking tags
Note	

VLI 1.5

1.5 mm²

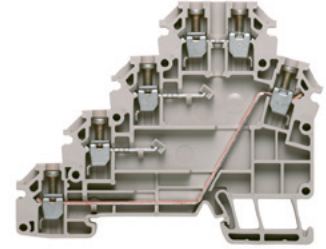

6.15 x 69 x 64	
24 / 4	
0.13...4	

IEC	UL	CSA
250	300 (D)	
17.5	10 (D)	
1.5	AWG 26...12	
4 kV / 3		
A3 / V-0		
94		
Rated connection		
0.5...4 / 0.5...2.5		
0.5...4 / 0.5...2.5		
0.4...0.6 Nm (M 2.5)		
8 / 0.6 x 3.5 mm		

Type	Qty.	Order No.
VLI 1.5 DB	50	1784120000
VLI 1.5/PE DB	50	1784130000

Type	Width	Qty.	Order No.
AP VLI1.5 DB	1.5 mm	20	1784150000
WEW 35/1	12 mm	50	1059000000
SDIS 0.6X3.5X100		1	9008390000
current			
VQB 1.5/50 SW	17.5 A	5	1635120000
VQB 1.5/50 BL	17.5 A	5	1633280000
VQB 1.5/50 RT	17.5 A	5	1633290000

Identification systems	(see assortment in catalogue 7) Marking tags
Note	

Plug-in modular terminals

Spade connection

Terminals with cable-lugs acc. to EN 61210 / VDE 0613-6.

In hazardous area applications, the installation instructions and the rated data specifications for accessories given in the technical appendix must be followed.

Width/Length/Height of lowest version	mm
max. current / max. cond. cross-section	A/mm ²
Max. clamping range	mm ²



Technical data

Rated data	
Rated voltage	V
Rated current	A
Rated cross-section	mm ²
Rated impulse withstand voltage / Pollution severity	
Gauge to IEC 60947-1 / Flammability class UL94	
Approvals	
Clamped conductors (H05V/H07V)	
Solid / stranded	mm ²
Flexible / Flexible with ferrule	mm ²
Tightening torque range (terminal screw)	
Stripping length / Blade size	mm/-
2 conductors with same cross-section (H05V/H07V)	
Solid / stranded	mm ²
Flexible / Flexible with ferrule	mm ²
Note	

Ordering data

Version	
	Dark beige Wemid
	Blue Wemid
Note	

Accessories

Screwable cross-connection	
	2-pole
	3-pole
	4-pole
	10-pole
End plate / Partition plate	
	Dark beige Wemid
	Blue Wemid
	Dark beige Wemid
	Blue Wemid
End bracket	
	Dark beige Wemid
Cover	
	With lightning flash symbol
	Blank, white

Identification systems	(see assortment in catalogue 7)
	Marking tags
Note	

WDU 2.5 F

2.5 mm²

Spade connection right

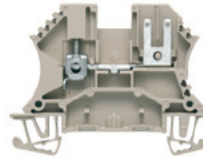

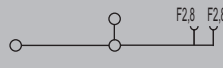
5.1 x 60 x 47	
12 / 4	
0.13...4	

IEC 60947-7-1, IEC 61210

IEC	UL	CSA
500	300 (C)	300 (C)
12	16 (C)	10 (C)
2.5	AWG 22...12	AWG 26...12
6 kV / 3		
A3 / V-0		
		
Rated connection	Further connection	
0.5...4 / 1.5...4		
0.5...4 / 0.5...2.5		
0.4...0.8 Nm (M 2.5)		
10 / 0.6 x 3.5 mm		
0.5...1.5		
0.5...1.5 / 0.5...1.5		
With insulating sleeves on cable lug connectors the voltage increases to 500 V. Current is limited by 2.8 mm cable lug connectors with 1 mm ² conductor.		

Type	Qty.	Order No.
WDU 2.5 F 2X2.8	100	1021800000
Note		
2.5 mm ² wires with wire ferrules including the plastic collar only clampable with diameter-optimised collar (Order no. 1333100000, pack of 500).		

Type	current	Qty.	Order No.
WQV 2.5/2	32 A	50	1053660000
WQV 2.5/3	32 A	50	1053760000
WQV 2.5/4	32 A	50	1053860000
WQV 2.5/10	32 A	20	1054460000
Width			
WAP 2.5-10	1.5 mm	50	1050000000
WAP 2.5-10 BL	1.5 mm	50	1050080000
WAP 16+35 WTW 2.5-10	1.5 mm	20	1050100000
WAP 16+35 WTW 2.5-10 BL	1.5 mm	20	1050180000
Width			
WEW 35/2	8 mm	100	1061200000
Width			
WAD 4 GE BED	4.5 mm	50	1072000000
WAD 4 WS	4.5 mm	50	1072100000

Type	current	Qty.	Order No.
DEK 5/5 / WS 12/5			
Insulating sleeve for cable-lug connector, 2.8 mm, Order no. 0386060000			

WDU 2.5 FF 2*2.8

1 mm²

Spade connection left and right

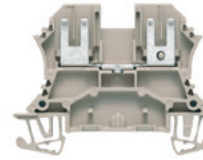

5.1 x 60 x 47	
12 / 1	
...1	

IEC 60947-7-1, IEC 61210

IEC	UL	CSA
500	300 (C)	300 (C)
12	16 (C)	10 (C)
1	AWG 22...12	AWG 26...12
6 kV / 3		
/ V-0		
		
Rated connection	Further connection	
With insulating sleeves on cable lug connectors the voltage increases to 500 V. Current is limited by 2.8 mm cable lug connectors with 1 mm ² conductor.		

Type	Qty.	Order No.
WDU 2.5 FF 2X2.8	100	1021900000
Note		
Technical data refers to the 2.8 mm cable-lug connector with 1 mm ² wire.		

Type	current	Qty.	Order No.
WQV 2.5/2	32 A	50	1053660000
WQV 2.5/3	32 A	50	1053760000
WQV 2.5/4	32 A	50	1053860000
WQV 2.5/10	32 A	20	1054460000
Width			
WAP 2.5-10	1.5 mm	50	1050000000
WAP 2.5-10 BL	1.5 mm	50	1050080000
WAP 16+35 WTW 2.5-10	1.5 mm	20	1050100000
WAP 16+35 WTW 2.5-10 BL	1.5 mm	20	1050180000
Width			
WEW 35/2	8 mm	100	1061200000
Width			
WAD 4 GE BED	4.5 mm	50	1072000000
WAD 4 WS	4.5 mm	50	1072100000

Type	current	Qty.	Order No.
DEK 5/5 / WS 12/5			
Insulating sleeve for cable-lug connector, 2.8 mm, Order no. 0386060000			

WDK 2.5 F

2.5 mm²

Spade connection right

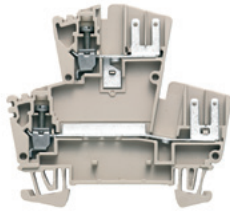

5.1 x 69.5 x 63
12 / 4
0.13...4

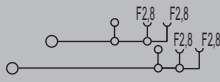

IEC 60947-7-1, IEC 61210

IEC	UL	CSA
400	300 (C)	300 (C)
12	10 (C)	10 (C)
2.5	AWG 22...12	AWG 26...12
6 kV / 3		
A3 / V-0		



Rated connection	Further connection
0.5...4 / 1.5...4	
0.5...4 / 0.5...2.5	
0.4...0.6 Nm (M 2.5)	
10 / 0.6 x 3.5 mm	
0.5...1.5	
0.5...1.5 / 0.5...1.5	
With insulating sleeves on cable lug connectors the voltage increases to 500 V. Current is limited by 2.8 mm cable lug connectors with 1 mm ² conductor.	

Type	Qty.	Order No.
WDK 2.5 F	100	1021600000
WDK 2.5 F BL	100	1021680000
2.5 mm ² wires with wire ferrules including the plastic collar only clampable with diameter-optimised collar (Order no. 1333100000, pack of 500).		

Type	current	Qty.	Order No.
WQV 2.5/2	32 A	50	1053660000
WQV 2.5/3	32 A	50	1053760000
WQV 2.5/4	32 A	50	1053860000
WQV 2.5/10	32 A	20	1054460000
Width			
WAP WDK2.5	1.5 mm	20	1059100000
WAP WDK2.5 BL	1.5 mm	20	1059180000
WTW EN	3 mm	20	1058800000
WEW 35/2	8 mm	100	1061200000
WAD 4 GE BED	4.5 mm	50	1072000000
WAD 4 WS	4.5 mm	50	1072100000

DEK 5/5 / WS 8/5

Insulating sleeve for cable-lug connector, 2.8 mm, Order no. 0386060000

WDK 2.5 FF

1 mm²

Spade connection left and right

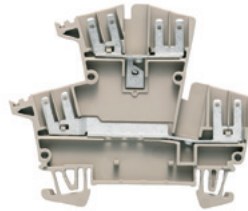

5.1 x 75.5 x 63
12 / 1
...1



IEC 60947-7-1, IEC 61210

IEC	UL	CSA
400	300 (C)	300 (C)
12	10 (C)	10 (C)
1	AWG 22...14	AWG 26...12
6 kV / 3		
/ V-0		



Rated connection	Further connection
0.5...4 / 1.5...4	
0.5...4 / 0.5...2.5	
0.4...0.6 Nm (M 2.5)	
10 / 0.6 x 3.5 mm	
0.5...1.5	
0.5...1.5 / 0.5...1.5	
With insulating sleeves on cable lug connectors the voltage increases to 500 V. Current is limited by 2.8 mm cable lug connectors with 1 mm ² conductor.	

Type	Qty.	Order No.
WDK 2.5 FF	100	1021700000

Type	current	Qty.	Order No.
WQV 2.5/2	32 A	50	1053660000
WQV 2.5/3	32 A	50	1053760000
WQV 2.5/4	32 A	50	1053860000
WQV 2.5/10	32 A	20	1054460000
Width			
WAP WDK2.5	1.5 mm	20	1059100000
WAP WDK2.5 BL	1.5 mm	20	1059180000
WTW EN	3 mm	20	1058800000
WEW 35/2	8 mm	100	1061200000
WAD 4 GE BED	4.5 mm	50	1072000000
WAD 4 WS	4.5 mm	50	1072100000

DEK 5/5 / WS 8/5

Insulating sleeve for cable-lug connector, 2.8 mm, Order no. 0386060000

WDK 2.5 FV

2.5 mm²

Spade connection right, both levels at one potential

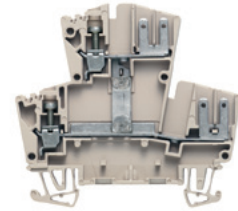

5.1 x 69.5 x 63
12 / 4
0.13...4

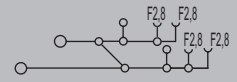

IEC 60947-7-1, IEC 61210

IEC	UL	CSA
400	300 (C)	300 (C)
12	10 (C)	10 (C)
2.5	AWG 22...12	AWG 26...12
6 kV / 3		
A3 / V-0		



Rated connection	Further connection
0.5...4 / 1.5...4	
0.5...4 / 0.5...2.5	
0.4...0.6 Nm (M 2.5)	
10 / 0.6 x 3.5 mm	
0.5...1.5	
0.5...1.5 / 0.5...1.5	
With insulating sleeves on cable lug connectors the voltage increases to 500 V. Current is limited by 2.8 mm cable lug connectors with 1 mm ² conductor.	

Type	Qty.	Order No.
WDK 2.5 FV	100	1022400000
2.5 mm ² wires with wire ferrules including the plastic collar only clampable with diameter-optimised collar (Order no. 1333100000, pack of 500).		

Type	current	Qty.	Order No.
WQV 2.5/2	32 A	50	1053660000
WQV 2.5/3	32 A	50	1053760000
WQV 2.5/4	32 A	50	1053860000
WQV 2.5/10	32 A	20	1054460000
Width			
WAP WDK2.5	1.5 mm	20	1059100000
WAP WDK2.5 BL	1.5 mm	20	1059180000
WTW EN	3 mm	20	1058800000
WEW 35/2	8 mm	100	1061200000
WAD 4 GE BED	4.5 mm	50	1072000000
WAD 4 WS	4.5 mm	50	1072100000

DEK 5/5 / WS 8/5

Insulating sleeve for cable-lug connector, 2.8 mm, Order no. 0386060000

Plug-in modular terminals

Plug-in connection

In hazardous area applications, the installation instructions and the rated data specifications for accessories given in the technical appendix must be followed.

Width/Length/Height of lowest version	mm
max. current / max. cond. cross-section	A/mm ²
Max. clamping range	mm ²

Technical data

Rated data	
Rated voltage	V
Rated current	A
Rated cross-section	mm ²
Rated impulse withstand voltage / Pollution severity Gauge to IEC 60947-1 / Flammability class UL94	
Approvals	
Clamped conductors (H05V/H07V)	
Solid / stranded	mm ²
Flexible / Flexible with ferrule	mm ²
Tightening torque range (terminal screw)	
Stripping length / Blade size	mm/-
2 conductors with same cross-section (H05V/H07V)	
Solid / stranded	mm ²
Flexible / Flexible with ferrule	mm ²
Note	

Ordering data

Version	Dark beige Wemid
Note	

Accessories

Pluggable cross-connection	
	10-pole 2-pole 3-pole 4-pole
End plate / Partition plate	
	With assembly peg Without peg
End bracket	
	Dark beige Wemid
Mounting block for socket connector	
	With assembly peg Without peg
Socket blocks	
	4-pole 6-pole 8-pole (with lateral dovetail) 4-pole (with lateral dovetail) 6-pole (with lateral dovetail) 8-pole
Coding	
	Coding element
Miscellaneous accessories	
	Cover for unused pins
Identification systems (see assortment in catalogue 7)	
	Marking tags
Note	

WDU 1.5 BLZ 5.08 WQV

1.5 mm²

Screwable cross-connection

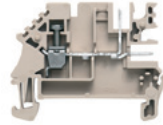

5.08 x 49 x 37.5	WQV	BLZ 5.08	BLZ 5.08
16 / 4			
0.13...4			

IEC 60947-7-1, IEC 61984

IEC	UL	CSA
250	300 (D)	300 (C)
16	10 (D)	10 (C)
1.5	AWG 22...12	AWG 26...12
4 kV / 3		
A3 / V-0		
® 		
Rated connection	Plug-in connection	
0.5...4 / 1.5...4		
0.5...4 / 0.5...2.5	0.5/ 0.5...2.5	
0.4...0.6 Nm (M 2.5)		
10 / 0.6 x 3.5 mm		
0.5...1.5		
0.5...1.5 / 0.5...1.5		
Size with BLZ female header: L=57.5 mm/H=55.5 mm 2.5 mm ² conductor w. ferrule with plastic collar, only with Order no. 1333100000 (500 pieces).		

WDU 1.5 BLZ 5.08 ZQV

1.5 mm²

Plug-in cross-connection

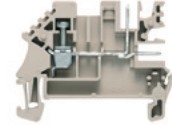

5.08 x 49 x 37.5	ZQV	BLZ 5.08	BLZ 5.08
16 / 4			
0.13...4			

IEC 60947-7-1, IEC 61984

IEC	UL	CSA
250		
16		
1.5		
4 kV / 3		
A3 / V-0		
Rated connection		
Plug-in connection		
0.5...4 / 1.5...4		
0.5...4 / 0.5...2.5		
0.4...0.6 Nm (M 2.5)		
10 / 0.6 x 3.5 mm		
0.5...1.5		
0.5...1.5 / 0.5...1.5		
Size with BLZ female header: L=57.5 mm/H=55.5 mm 2.5 mm ² conductor w. ferrule with plastic collar, only with Order no. 1333100000 (500 pieces).		

Type	Qty.	Order No.
WDU 1.5/BLZ 5.08	100	1577340000
WDU 1.5 BLA Order no. 1577260000 (100 pcs.). Techn. data same as WDU 1.5 BLZ.		

Type	Qty.	Order No.
WDU 1.5/ZQV/BLZ 5.08	100	1784460000

Type	current	Qty.	Order No.
Width			
WAP WDU1.5/BLZ/ZA	2.5 mm	50	1577320000
WAP WDU1.5/BLZ	2.5 mm	50	1577330000
WEW 35/2	8 mm	100	1061200000
WBB ZA WDU1.5/BL 10/10	5 mm	10	1068260000
WBB WDU1.5/BL...	5 mm	10	1068160000

Type	current	Qty.	Order No.
ZQV 2.5N/10 GE	24 A	20	1693880000
ZQV 2.5N/2 GE	24 A	60	1693800000
ZQV 2.5N/3 GE	24 A	60	1693810000
ZQV 2.5N/4 GE	24 A	60	1693820000
Width			
WAP WDU1.5/BLZ/ZA	2.5 mm	50	1577320000
WAP WDU1.5/BLZ	2.5 mm	50	1577330000
WEW 35/1	12 mm	50	1059000000
WBB ZA WDU1.5/BL 10/10	5 mm	10	1068260000
WBB WDU1.5/BL...	5 mm	10	1068160000
BLZ 5.08/04/180 SN OR BX		100	1526660000
BLZ 5.08/06/180 SN OR BX		50	1526860000
BLZ 5.08/08/180 SN OR BX		50	1527060000
BLZ 5.08/04/180B SN OR BX		100	1528960000
BLZ 5.08/06/180B SN OR BX		50	1529160000
BLZ 5.08/08/180B SN OR BX		50	1529360000
BLZ/SL KO SW		50	1545710000
WAD WDU1.5/BLZ/BLA	9.48 mm	20	1577400000

DEK 5/5 / WS 12/5
Both sides of the WBB can be directly mounted using assembly pins (order number 1068260000).

DEK 5/5 / WS 12/5
Both sides of the WBB can be directly mounted using assembly pins (order number 1068260000).

WDK 2.5 BLZ/5.08

2.5 mm²

Double terminal pitch 5.08

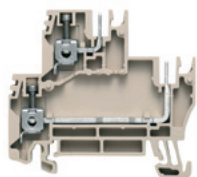

5.08 x 58 x 53
18 / 4
0.13...4



IEC 60947-7-1, IEC 61984

IEC	UL	CSA
250	300 (D)	300 (D)
16.5	10 (D)	24 (D)
2.5	AWG 26...12	AWG 26...12
4 kV / 3		
A3 / V-0		



Rated connection	Plug-in connection
0.5...4 / 1.5...2.5	
0.5...4 / 0.5...2.5	0.5/ 0.5...2.5
(M 2.5)	
10 / 0.6 x 3.5 mm	
0.5...1.5	
0.5...1.5 / 0.5...1.5	
Size with BLZ female header: length 58 mm / height 63.5 mm	

Type	Qty.	Order No.
WDK 2.5/BLZ/5.08/ZA	100	1034400000
2.5 mm ² wires with wire ferrules including the plastic collar only clampable with diameter-optimised collar (Order no. 1333100000, pack of 500).		

Type	current	Qty.	Order No.
Width			
WAP WDK2.5/BLZ/M.ZA	5.08 mm	20	1070100000
WAP WDK2.5/BLZ/O.ZA	5.08 mm	20	1070000000
WEW 35/1	12 mm	50	1059000000
WBB ZA WDK2.5/BL5.08	5 mm	10	1072760000
WBB WDK2.5/BL5.08	5 mm	10	1072660000
BLZ 5.08/04/180 SN OR BX		100	1526660000
BLZ 5.08/06/180 SN OR BX		50	1526860000
BLZ 5.08/08/180 SN OR BX		50	1527060000
BLZ 5.08/04/180B SN OR BX		100	1528960000
BLZ 5.08/06/180B SN OR BX		50	1529160000
BLZ 5.08/08/180B SN OR BX		50	1529360000
BLZ/SL KO SW		50	1545710000
WAD WDU1.5/BLZ/BLA	9.48 mm	20	1577400000

DEK 5/5 / WS 8/5

External cross-connection WQB A, refer to the W-Series accessories section, "Potential distribution".

WDK 2.5 BLZ/5.08/ZA V

2.5 mm²

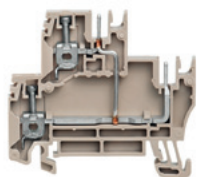

5.08 x 58 x 53
18 / 4
0.13...4

IEC 60947-7-1, IEC 61984

IEC	UL	CSA
250		
16.5		
2.5		
4 kV / 3		
A3 / V-0		

Rated connection	Plug-in connection
0.5...4 / 1.5...2.5	
0.5...4 / 0.5...2.5	0.5/ 0.5...2.5
(M 2.5)	
10 / 0.6 x 3.5 mm	
0.5...1.5	
0.5...1.5 / 0.5...1.5	

Type	Qty.	Order No.
WDK 2.5/BLZ/5.08/ZA V	100	1027410000

Type	current	Qty.	Order No.
Width			
WAP WDK2.5/BLZ/M.ZA	5.08 mm	20	1070100000
WAP WDK2.5/BLZ/O.ZA	5.08 mm	20	1070000000
WEW 35/1	12 mm	50	1059000000
WBB ZA WDK2.5/BL5.08	5 mm	10	1072760000
WBB WDK2.5/BL5.08	5 mm	10	1072660000
BLZ 5.08/04/180 SN OR BX		100	1526660000
BLZ 5.08/06/180 SN OR BX		50	1526860000
BLZ 5.08/08/180 SN OR BX		50	1527060000
BLZ 5.08/04/180B SN OR BX		100	1528960000
BLZ 5.08/06/180B SN OR BX		50	1529160000
BLZ 5.08/08/180B SN OR BX		50	1529360000
BLZ/SL KO SW		50	1545710000
WAD WDU1.5/BLZ/BLA	9.48 mm	20	1577400000

DEK 5/5 / WS 8/5

Plug-in modular terminals

WT4 4 AN/2

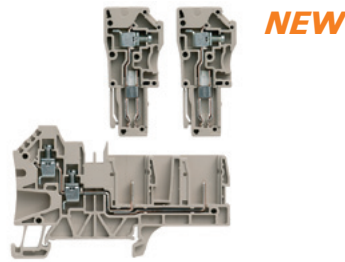
4 mm²

In hazardous area applications, the installation instructions and the rated data specifications for accessories given in the technical appendix must be followed.

Width/Length/Height of lowest version	mm
max. current / max. cond. cross-section	A/mm ²
Max. clamping range	mm ²

6.1 x 84.3 x 50.7
/ 6
0.5...6

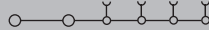

Technical data

Rated data	
Rated voltage	V
Rated current	A
Rated cross-section	mm ²
Rated impulse withstand voltage / Pollution severity Gauge to IEC 60947-1 / Flammability class UL94	
Approvals	
Clamped conductors (H05V/H07V)	
Solid / stranded	mm ²
Flexible / Flexible with ferrule	mm ²
Tightening torque range (terminal screw)	
Stripping length / Blade size	
Note	

IEC	UL	CSA
800	600 (C)	
32	30 (C)	
4	AWG 26...10	
8 kV / 3		
A4 / V-0		
Rated connection		
Further connection		
0.5...6 / 0.5...6		
0.5...4 / 0.5...4		
/ 0.6 x 3.5 mm		
Note		

Ordering data

Version
Dark beige Wemid
Note

Type	Qty.	Order No.
WT4 4AN/2	50	1107680000
Note		

Accessories

Pluggable cross-connection	
	2-pole
	3-pole
	4-pole
	10-pole
End plate / Partition plate	
	Dark beige Wemid
End bracket	
	Dark beige Wemid
Miscellaneous accessories WeiCoS	
	Locking element
	Coding element
	Strain relief
Screwdriver	
	Standard
Plug-in connector	

Type	current	Qty.	Order No.
ZQV 4N/2 GE	32 A	60	1758250000
ZQV 4N/3 GE	32 A	60	1762630000
ZQV 4N/4 GE	32 A	60	1762620000
ZQV 4N/10 GE	32 A	20	1758260000
Width			
WAP WT4/4AN/2	1.5 mm	50	1107780000
WEW 35/2	8 mm	100	1061200000
ZVR ZP4	5.5 mm	25	1855250000
KOSF ZT4	5.4 mm	50	1856860000
ZZE ZP4	12.5 mm	25	1855260000
SDS 0.6X3.5X100		1	9008330000
WP4/1AN/1		50	1107790000
WP4/1AN/1 ZA		50	1108490000
WP4/1AN/10		10	1107800000
Note			

Identification systems	(see assortment in catalogue 7)
	Marking tags
Note	

DEK 5/6
Note

WMF marshalling terminals

Multi-function terminal block products for marshalling signals

In process control systems for facilities in the process and power generation sectors, incoming signals from field devices are often connected with terminal blocks within marshalling cabinets. Terminal blocks are used despite the existence of alternative technologies such as Remote I/O and Fieldbus. This is mainly because they offer a robust and simple connection system, and can be clearly labelled for orderly installation.

D

Weidmüller's new WMF (Weidmüller Multi-Functional) line of terminal blocks provides a multi-functional solution for marshalling signals. This space-saving terminal block combines all the necessary functionality into a single solution. It features an integrated shield connection and can be used with feed-through, fuse and disconnect functionality. The three cross-connection channels and wide variety of labelling options offer additional flexibility.

A solution to fit any scenario

Feed-through, fuse and disconnect functions, and even an integrated shield connection: all the required functions are combined together in this design.

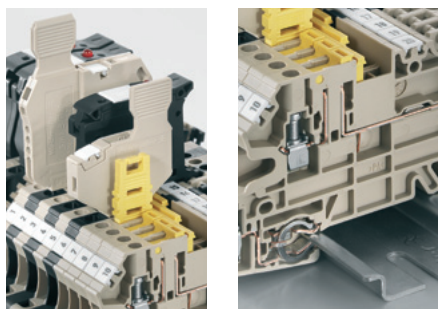

Saves space in the switching cabinet

The 5 mm width allows for high-density wiring. The integrated shield/PE connection replaces the shield-connection devices or the PE terminal blocks.

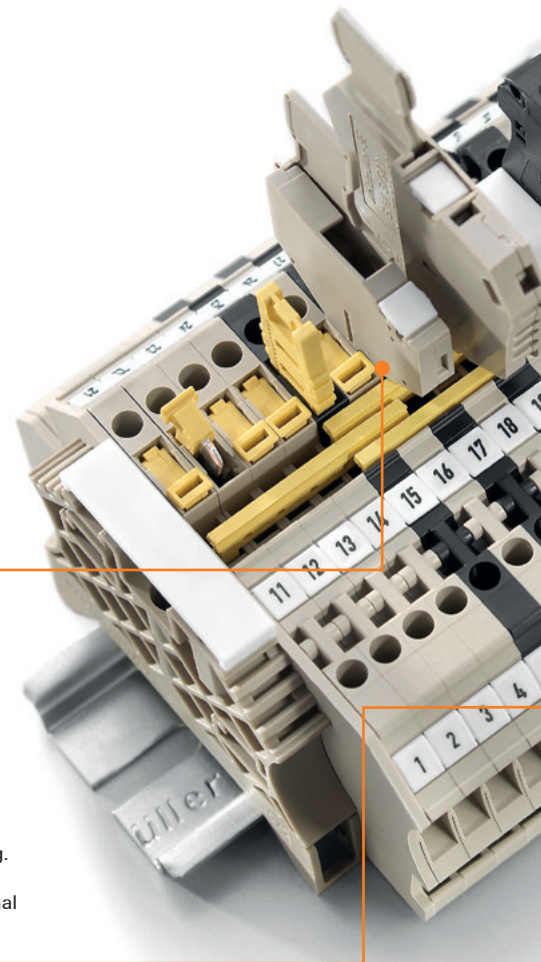

Fuse is convenient to replace

The new design of the fuse holder includes a hinged fuse carrier – this enables the fuse to be replaced quickly and reliably.

**Optional LED status indicator**

Easy identification during troubleshooting and no interference signals in control circuit – because of optional bright LED status display and minimal leakage current (less than 0.5 mA).

**Cross-connection channels**

The WMF terminal block has three cross-connection channels; they are a very flexible solution for bundling and looping through of potentials. The standard ZQV cross-connections can be used to join both the neutral wire and also a shielded potential voltage across a large number of poles.

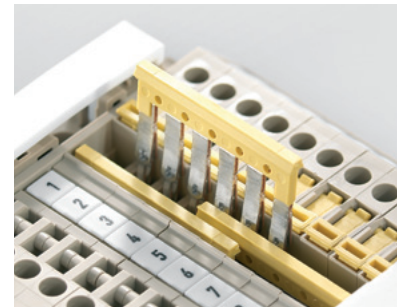
**Global reliability**

Weidmüller's proven screw-connection mechanism guarantees that the product will be easy to operate, recognise, and maintain anywhere throughout the world.

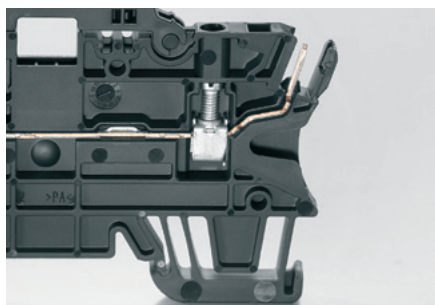
**Marshalling with Plug & Play**

Instead of using a screw connection to contact each signal at the routing levels, pre-assembled cable sets with BLZ mating profiles are used. This saves you valuable wiring time in the field.

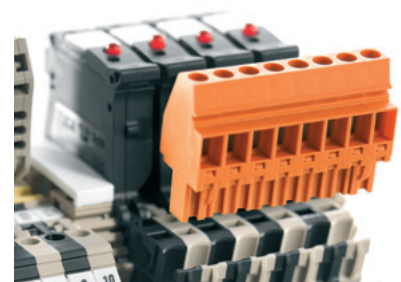

Multi-functional terminals

Multi-functional terminals

In hazardous area applications, the installation instructions and the rated data specifications for accessories given in the technical appendix must be followed.

Width/Length/Height of lowest version	mm
max. current / max. cond. cross-section	A/mm ²
Max. clamping range	mm ²

Technical data

Rated data	
Rated voltage	V
Rated current	A
Rated cross-section	mm ²
Rated impulse withstand voltage / Pollution severity Gauge to IEC 60947-1 / Flammability class UL94	
Approvals	
Clamped conductors (H05V/H07V)	
Solid / stranded	mm ²
Flexible / Flexible with ferrule	mm ²
Tightening torque range (terminal screw)	
Stripping length / Blade size	mm/-
Note	

Ordering data

Version	Dark beige Wemid Blue Wemid
Note	

Accessories

Pluggable cross-connection	
	2-pole
	3-pole
	4-pole
	10-pole
	20-/24-pole
End plate / Partition plate	
	Dark beige Wemid
End bracket	
	Dark beige Wemid
Screwdriver	
	Standard
Holder for cartridge fuse 5 x 20mm	
	400 V AC/DC, without LED
	10 - 36 V AC/DC, red LED
	140 - 250 V AC/DC, red LED
Module connector (max. 250 V)	
	without fittings
	with wire jumper
	With 1N4007 diode
Disconnect plug	
	removable, as replacement for release lever
Identification systems	
	(see assortment in catalogue 7) Marking tags
Note	

WMF 2.5

2.5 mm²

NEW

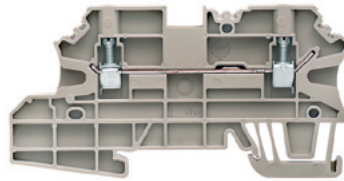

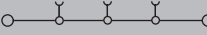
5.08 x 88 x 45	
32 / 4	
0.5...4	

IEC	UL	CSA
800	600 (C)	600 (C)
24	20 (C)	26 (C)
2.5	AWG 26...12	AWG 26...12
8 kV / 3		
A3 / V-0		
Rated connection		
0.5...4 / 1.5...4		
0.5...4 / 0.5...2.5		
0.5...0.6 Nm (M 3)		
10 / 0.6 x 3.5 mm		

Type	Qty.	Order No.
WMF 2.5	50	1143070000
WMF 2.5 BL	50	1270040000

Type	current	Qty.	Order No.
ZQV 2.5N/2 GE	24 A	60	1693800000
ZQV 2.5N/3 GE	24 A	60	1693810000
ZQV 2.5N/4 GE	24 A	60	1693820000
ZQV 2.5N/10 GE	24 A	20	1693880000
ZQV 2.5N/20 GE	24 A	20	1909000000
Width			
AP WMF2.5	1.5 mm	50	1142990000
WEW 35/2			
	8 mm	100	1061200000
SDS 0.6X3.5X100			
		1	9008330000
SIHA 3/G20			
	5.95 mm	25	7921560000
	5.95 mm	25	7921570000
	5.95 mm	25	7921600000
FUCR SW			
	8 mm	10	1167630000
	8 mm	10	1167640000
	8 mm	10	1167680000
BEST/DRBR			
	5.1 mm	50	1878570000
BEST/D			
	5.1 mm	50	1878560000

DEK 5/5 / WS 10/5

WMF 2.5 DI

2.5 mm²

NEW

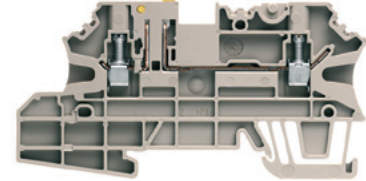

5.08 x 88 x 45	
20 / 4	
0.5...4	

IEC	UL	CSA
500	600 (C)	
20	19 (C)	
2.5	AWG 26...12	
8 kV / 3		
A3 / V-0		
Rated connection		
0.5...4 / 1.5...4		
0.5...4 / 0.5...2.5		
0.5...0.6 Nm (M 3)		
10 / 0.6 x 3.5 mm		

Type	Qty.	Order No.
WMF 2.5 DI	50	1143020000
WMF 2.5 DI BL	50	1270070000

Type	current	Qty.	Order No.
ZQV 2.5N/2 GE	24 A	60	1693800000
ZQV 2.5N/3 GE	24 A	60	1693810000
ZQV 2.5N/4 GE	24 A	60	1693820000
ZQV 2.5N/10 GE	24 A	20	1693880000
ZQV 2.5N/20 GE	24 A	20	1909000000
Width			
AP WMF2.5	1.5 mm	50	1142990000
WEW 35/2			
	8 mm	100	1061200000
SDS 0.6X3.5X100			
		1	9008330000
SIHA 3/G20			
	5.95 mm	25	7921560000
	5.95 mm	25	7921570000
	5.95 mm	25	7921600000
FUCR SW			
	8 mm	10	1167630000
	8 mm	10	1167640000
	8 mm	10	1167680000
BEST/DRBR			
	5.1 mm	50	1878570000
BEST/D			
	5.1 mm	50	1878560000

DEK 5/5 / WS 10/5

WMF 2.5 DI PE

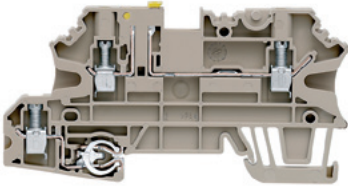
2.5 mm²**NEW**

5.08 x 88 x 45
20 / 4
0.5...4

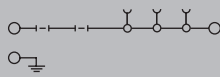

IEC	UL	CSA
250	600 (C)	
20	19 (C)	
2.5	AWG 26...12	
8 kV / 3		
A3 / V-0		

**Rated connection**

0.5...4 / 1.5...4

0.5...4 / 0.5...2.5

0.5...0.6 Nm (M 3)

10 / 0.6 x 3.5 mm

Type	Qty.	Order No.
WMF 2.5 DI PE	50	1143030000
WMF 2.5 DI PE BL	50	1270080000

Type	current	Qty.	Order No.
ZQV 2.5N/2 GE	24 A	60	1693800000
ZQV 2.5N/3 GE	24 A	60	1693810000
ZQV 2.5N/4 GE	24 A	60	1693820000
ZQV 2.5N/10 GE	24 A	20	1693880000
ZQV 2.5N/20 GE	24 A	20	1909000000
Width			
AP WMF2.5	1.5 mm	50	1142990000
WEW 35/1	12 mm	50	1059000000
SDS 0.6X3.5X100		1	9008330000
SIHA 3/G20	5.95 mm	25	7921560000
SIHA 3/G20/LD 10-36V	5.95 mm	25	7921570000
SIHA 3/G20/LD 140-250V	5.95 mm	25	7921600000
FUCR SW	8 mm	10	1167630000
FUCR 10-36V SW	8 mm	10	1167640000
FUCR 100-250V SW	8 mm	10	1167680000
BEST	5.1 mm	50	1833100000
BEST/DRBR	5.1 mm	50	1878570000
BEST/D	5.1 mm	50	1878560000
TNST		50	1833090000

DEK 5/5 / WS 10/5

Multi-functional terminals

Multi-functional terminals

In hazardous area applications, the installation instructions and the rated data specifications for accessories given in the technical appendix must be followed.

Width/Length/Height of lowest version	mm
max. current / max. cond. cross-section	A/mm ²
Max. clamping range	mm ²

Technical data

Rated data	
Rated voltage	V
Rated current	A
Rated cross-section	mm ²
Rated impulse withstand voltage / Pollution severity	
Gauge to IEC 60947-1 / Flammability class UL94	
Approvals	
Clamped conductors (H05V/H07V)	
Solid / stranded	mm ²
Flexible / Flexible with ferrule	mm ²
Tightening torque range (terminal screw)	
Stripping length / Blade size	mm/-
Note	

Ordering data

Version	Black Wemid
	10-36 V AC/DC, with LED
	30-70 V AC/DC, with LED
	60-150 V AC/DC, with LED
	100 - 250 V AC/DC, with LED
Note	

Accessories

Pluggable cross-connection	
	2-pole
	3-pole
	4-pole
	10-pole
	20-/24-pole
End plate / Partition plate	
	Dark beige Wemid
End bracket	
	Dark beige Wemid
Screwdriver	
	Standard
Holder for cartridge fuse 5 x 20mm	
	400 V AC/DC, without LED
	10 - 36 V AC/DC, red LED
	140 - 250 V AC/DC, red LED
Module connector (max. 250 V)	
	without fittings
	with wire jumper
	With 1N4007 diode
Disconnect plug	
	removable, as replacement for release lever
Identification systems	
	(see assortment in catalogue 7)
	Marking tags
Note	

WMF 2.5 FU

2.5 mm²

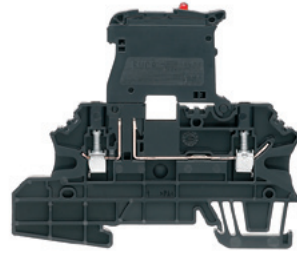

NEW

5.08 x 88 x 74.5
6.3 / 4
0.5...4

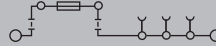

IEC	UL	CSA
250	600 (C)	600 (C)
6.3	17 (C)	17 (C)
2.5	AWG 26...12	AWG 26...12
8 kV / 3		
A3 / V-0		
Rated connection		
0.5...4 / 1.5...4		
0.5...4 / 0.5...2.5		
0.5...0.6 Nm (M 3)		
10 / 0.6 x 3.5 mm		
Note		

Type	Qty.	Order No.
WMF 2.5 FU SW	50	1162920000
WMF 2.5 FU 10-36V SW	50	1162930000
WMF 2.5 FU 30-70V SW	50	1162940000
WMF 2.5 FU 60-150V SW	50	1162950000
WMF 2.5 FU 100-250V SW	50	1162960000
The WMF FU terminals may not be aligned directly under one another.		

Type	current	Qty.	Order No.
ZQV 2.5N/2 GE	24 A	60	1693800000
ZQV 2.5N/3 GE	24 A	60	1693810000
ZQV 2.5N/4 GE	24 A	60	1693820000
ZQV 2.5N/10 GE	24 A	20	1693880000
ZQV 2.5N/20 GE	24 A	20	1909000000
Width			
AP WMF2.5	1.5 mm	50	1142990000
WEW 35/2	8 mm	100	1061200000
SDS 0.6X3.5X100		1	9008330000
SIHA 3/G20	5.95 mm	25	7921560000
SIHA 3/G20/LD 10-36V	5.95 mm	25	7921570000
SIHA 3/G20/LD 140-250V	5.95 mm	25	7921600000
FUCR SW	8 mm	10	1167630000
FUCR 10-36V SW	8 mm	10	1167640000
FUCR 100-250V SW	8 mm	10	1167680000
BEST	5.1 mm	50	1833100000
BEST/DRBR	5.1 mm	50	1878570000
BEST/D	5.1 mm	50	1878560000
TNST		50	1833090000
DEK 5/5 / WS 10/5			
Note			

WMF 2.5 FU PE

2.5 mm²



NEW

5.08 x 88 x 74.5
6.3 / 4
0.5...4

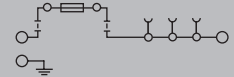

IEC	UL	CSA
250	600 (C)	600 (C)
6.3	17 (C)	17 (C)
2.5	AWG 26...12	AWG 26...12
8 kV / 3		
A3 / V-0		
Rated connection		
0.5...4 / 1.5...4		
0.5...4 / 0.5...2.5		
0.5...0.6 Nm (M 3)		
10 / 0.6 x 3.5 mm		
Note		

Type	Qty.	Order No.
WMF 2.5 FU PE SW	50	1163040000
WMF 2.5 FU PE 10-36V SW	50	1163050000
WMF 2.5 FU PE 30-70V SW	50	1163060000
WMF 2.5 FU PE 60-150V SW	50	1163070000
WMF 2.5 FU PE 100-250V SW	50	1163080000
The WMF FU terminals may not be aligned directly under one another.		

Type	current	Qty.	Order No.
ZQV 2.5N/2 GE	24 A	60	1693800000
ZQV 2.5N/3 GE	24 A	60	1693810000
ZQV 2.5N/4 GE	24 A	60	1693820000
ZQV 2.5N/10 GE	24 A	20	1693880000
ZQV 2.5N/20 GE	24 A	20	1909000000
Width			
AP WMF2.5	1.5 mm	50	1142990000
WEW 35/2	8 mm	100	1061200000
SDS 0.6X3.5X100		1	9008330000
SIHA 3/G20	5.95 mm	25	7921560000
SIHA 3/G20/LD 10-36V	5.95 mm	25	7921570000
SIHA 3/G20/LD 140-250V	5.95 mm	25	7921600000
FUCR SW	8 mm	10	1167630000
FUCR 10-36V SW	8 mm	10	1167640000
FUCR 100-250V SW	8 mm	10	1167680000
BEST	5.1 mm	50	1833100000
BEST/DRBR	5.1 mm	50	1878570000
BEST/D	5.1 mm	50	1878560000
TNST		50	1833090000
DEK 5/5 / WS 10/5			
Note			

Multi-functional terminals

Multi-functional terminals

WMF 2.5 DI BLZ PE

2.5 mm²

NEW

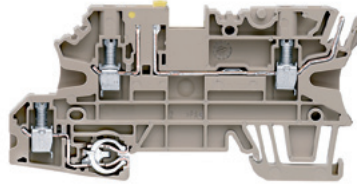

In hazardous area applications, the installation instructions and the rated data specifications for accessories given in the technical appendix must be followed.

Width/Length/Height of lowest version	mm
max. current / max. cond. cross-section	A/mm ²
Max. clamping range	mm ²

5.08 x 90 x 45	BLZ 5.08
20 / 4	
0.5...4	

Technical data

Rated data	
Rated voltage	V
Rated current	A
Rated cross-section	mm ²
Rated impulse withstand voltage / Pollution severity	
Gauge to IEC 60947-1 / Flammability class UL94	
Approvals	
Clamped conductors (H05V/H07V)	
Solid / stranded	mm ²
Flexible / Flexible with ferrule	mm ²
Tightening torque range (terminal screw)	
Stripping length / Blade size	mm/-
Note	

IEC	UL	CSA
250	300 (D)	300 (D)
20	10 (D)	10 (D)
2.5	AWG 26...12	AWG 26...12
8 kV / 3		
A3 / V-0		
Rated connection		
0.5...4 / 1.5...4		
0.5...4 / 0.5...2.5		
0.5...0.6 Nm (M 3)		
10 / 0.6 x 3.5 mm		
With BLZ plug the nominal current is reduced to 15.5 A.		

Ordering data

Version	Dark beige Wemid
Note	

Type	Qty.	Order No.
WMF 2.5 DI BLZ PE	50	1143010000

Accessories

Pluggable cross-connection	
	2-pole
	3-pole
	4-pole
	10-pole
	20-/24-pole
End plate / Partition plate	
	Dark beige Wemid
End bracket	
	Dark beige Wemid
Screwdriver	
	Standard
Holder for cartridge fuse 5 x 20mm	
	400 V AC/DC, without LED
	10 - 36 V AC/DC, red LED
	140 - 250 V AC/DC, red LED
Module connector (max. 250 V)	
	without fittings
	with wire jumper
	With 1N4007 diode
Disconnect plug	
	removable, as replacement for release lever
Identification systems (see assortment in catalogue 7)	
	Marking tags
Note	

Type	current	Qty.	Order No.
ZQV 2.5N/2 GE	24 A	60	1693800000
ZQV 2.5N/3 GE	24 A	60	1693810000
ZQV 2.5N/4 GE	24 A	60	1693820000
ZQV 2.5N/10 GE	24 A	20	1693880000
ZQV 2.5N/20 GE	24 A	20	1909000000
Width			
AP WMF2.5	1.5 mm	50	1142990000
WEW 35/1	12 mm	50	1059000000
SDS 0.6X3.5X100		1	9008330000
SIHA 3/G20	5.95 mm	25	7921560000
SIHA 3/G20/LD 10-36V	5.95 mm	25	7921570000
SIHA 3/G20/LD 140-250V	5.95 mm	25	7921600000
FUCR SW	8 mm	10	1167630000
FUCR 10-36V SW	8 mm	10	1167640000
FUCR 100-250V SW	8 mm	10	1167680000
BEST	5.1 mm	50	1833100000
BEST/DRBR	5.1 mm	50	1878570000
BEST/D	5.1 mm	50	1878560000
TNST		50	1833090000

DEK 5/5 / WS 10/5

Multi-functional terminals

In hazardous area applications, the installation instructions and the rated data specifications for accessories given in the technical appendix must be followed.

Width/Length/Height of lowest version	mm
max. current / max. cond. cross-section	A/mm ²
Max. clamping range	mm ²

Technical data

Rated data	
Rated voltage	V
Rated current	A
Rated cross-section	mm ²
Rated impulse withstand voltage / Pollution severity	
Gauge to IEC 60947-1 / Flammability class UL94	
Approvals	
Clamped conductors (H05V/H07V)	
Solid / stranded	mm ²
Flexible / Flexible with ferrule	mm ²
Tightening torque range (terminal screw)	
Stripping length / Blade size	mm/-
Note	

Ordering data

Version	
	Black Wemid
	10-36 V AC/DC, with LED
	30-70 V AC/DC, with LED
	60-150 V AC/DC, with LED
	100 - 250 V AC/DC, with LED
Note	

Accessories

Pluggable cross-connection	
	2-pole
	3-pole
	4-pole
	10-pole
	20-/24-pole
End plate / Partition plate	
	Dark beige Wemid
End bracket	
	Dark beige Wemid
Screwdriver	
	Standard
Holder for cartridge fuse 5 x 20mm	
	400 V AC/DC, without LED
	10 - 36 V AC/DC, red LED
	140 - 250 V AC/DC, red LED
Module connector (max. 250 V)	
	without fittings
	with wire jumper
	With 1N4007 diode
Disconnect plug	
	removable, as replacement for release lever
Identification systems	
	(see assortment in catalogue 7)
	Marking tags
Note	

WMF 2.5 FU BLZ

2.5 mm²

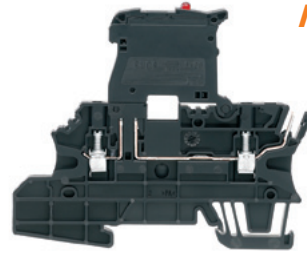

NEW

5.08 x 90 x 74.5
6.3 / 4
0.5...4

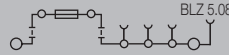

IEC	UL	CSA
250	300 (D)	300 (D)
6.3	10 (D)	10 (D)
2.5	AWG 26...12	AWG 26...12
8 kV / 3		
A3 / V-0		
Rated connection		Further connection
0.5...4 / 1.5...4		
0.5...4 / 0.5...2.5		
0.5...0.6 Nm (M 3)		
10 / 0.6 x 3.5 mm		
Note		

Type	Qty.	Order No.
WMF 2.5 FU BLZ SW	50	1162980000
WMF 2.5 FU BLZ 10-36V SW	50	1162990000
WMF 2.5 FU BLZ 30-70V SW	50	1163000000
WMF 2.5 FU BLZ 60-150V SW	50	1163010000
WMF 2.5 FU BLZ 100-250V SW	50	1163020000
Note		

Type	current	Qty.	Order No.
ZQV 2.5N/2 GE	24 A	60	1693800000
ZQV 2.5N/3 GE	24 A	60	1693810000
ZQV 2.5N/4 GE	24 A	60	1693820000
ZQV 2.5N/10 GE	24 A	20	1693880000
ZQV 2.5N/20 GE	24 A	20	1909000000
Width			
AP WMF2.5	1.5 mm	50	1142990000
WEW 35/1	12 mm	50	1059000000
SDS 0.6X3.5X100		1	9008330000
SIHA 3/G20	5.95 mm	25	7921560000
SIHA 3/G20/LD 10-36V	5.95 mm	25	7921570000
SIHA 3/G20/LD 140-250V	5.95 mm	25	7921600000
FUCR SW	8 mm	10	1167630000
FUCR 10-36V SW	8 mm	10	1167640000
FUCR 100-250V SW	8 mm	10	1167680000
Width			
BEST	5.1 mm	50	1833100000
BEST/DRBR	5.1 mm	50	1878570000
BEST/D	5.1 mm	50	1878560000
TNST		50	1833090000
Note			
DEK 5/5 / WS 10/5			

WMF 2.5 FU BLZ PE

2.5 mm²

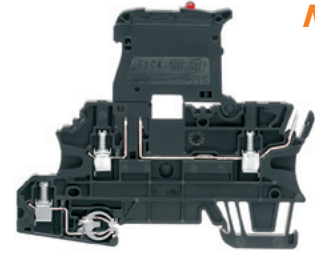

NEW

5.08 x 90 x 74.5
6.3 / 4
0.5...4

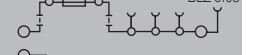

IEC	UL	CSA
250	300 (D)	300 (D)
6.3	10 (D)	10 (D)
2.5	AWG 26...12	AWG 26...12
8 kV / 3		
A3 / V-0		
Rated connection		Further connection
0.5...4 / 1.5...4		
0.5...4 / 0.5...2.5		
0.5...0.6 Nm (M 3)		
10 / 0.6 x 3.5 mm		
Note		

Type	Qty.	Order No.
WMF 2.5 FU BLZ PE SW	50	1162820000
WMF 2.5 FU BLZ PE 10-36V SW	50	1162830000
WMF 2.5 FU BLZ PE 30-70V SW	50	1162840000
WMF 2.5 FU BLZ PE 60-150V SW	50	1162850000
WMF 2.5 FU BLZ PE 100-250V SW	50	1162860000
Note		

Type	current	Qty.	Order No.
ZQV 2.5N/2 GE	24 A	60	1693800000
ZQV 2.5N/3 GE	24 A	60	1693810000
ZQV 2.5N/4 GE	24 A	60	1693820000
ZQV 2.5N/10 GE	24 A	20	1693880000
ZQV 2.5N/20 GE	24 A	20	1909000000
Width			
AP WMF2.5	1.5 mm	50	1142990000
WEW 35/1	12 mm	50	1059000000
SDS 0.6X3.5X100		1	9008330000
SIHA 3/G20	5.95 mm	25	7921560000
SIHA 3/G20/LD 10-36V	5.95 mm	25	7921570000
SIHA 3/G20/LD 140-250V	5.95 mm	25	7921600000
FUCR SW	8 mm	10	1167630000
FUCR 10-36V SW	8 mm	10	1167640000
FUCR 100-250V SW	8 mm	10	1167680000
Width			
BEST	5.1 mm	50	1833100000
BEST/DRBR	5.1 mm	50	1878570000
BEST/D	5.1 mm	50	1878560000
TNST		50	1833090000
Note			
DEK 5/5 / WS 10/5			

Multi-functional terminals – Accessories

Technical data

Rated data according to IEC 60664-1 / IEC 61984			
Clamping range, max.	mm ²	0.13...4	
Solid core H05(07) V-U	mm ²	0.2...4	
Stranded H07 V-R	mm ²	0.2...4	
Flexible H05(07) V-K	mm ²	0.2...4	
Flexible with ferrule	mm ²	0.2...4	
Ferrule with plastic collar	mm ²	0.2...2.5	
Stripping length	mm	7	
Screwdriver blade	mm	0.6 x 3.5	
according to norm		DIN 5264	
Tightening torque range	Nm	0.4...0.5	
Rated current			
at ambient temperature		20 °C	40 °C
	A	15	12
Overvoltage category		III	III II
Pollution severity		3	2 2
Rated voltage	V	250	320 400
Rated impulse voltage	kV	4	4 4
UL 1059 Rated data			
		B	C D
Rated voltage	V	300	300
Rated current	A	15	10
AWG conductor		26...12	
CSA C22.2 Rated data			
		B	C D
Rated voltage	V	300	300
Rated current	A	10	0
AWG conductor		26...12	
Material data			
Type of insulation material		PBT	
Flammability class		V-0	
Contact base material		Copper alloy	
Material of contact surface		tinned	

BLZ 5.08/90

Can be mounted directly side-by-side without loss of poles.

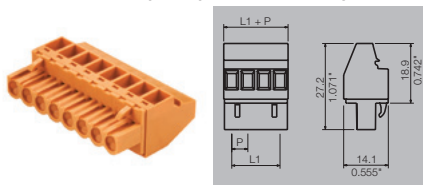

Ordering data

Pitch 5.08 mm					
Colour of plastic			orange	black	
Pol.	L1 mm	(inch)	Qty.	Order No.	Order No.
2	5.08	(0.200)	180	1948000000	1948240000
4	15.24	(0.600)	90	1948020000	1948260000
8	35.56	(1.400)	42	1948060000	1948300000
12	55.88	(2.200)	30	1948110000	1948340000
16	76.20	(3.000)	18	1948150000	1948380000

BLZP 5.08/90F

With screw flange

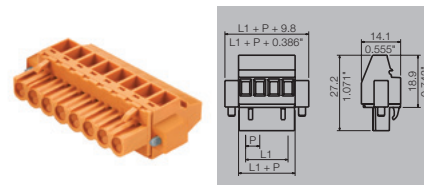

Ordering data

Pitch 5.08 mm					
Colour of plastic			orange	black	
Pol.	L1 mm	(inch)	Qty.	Order No.	Order No.
2	5.08	(0.200)	90	1949800000	1950040000
4	15.24	(0.600)	60	1949820000	1950060000
8	35.56	(1.400)	36	1949860000	1950100000
12	55.88	(2.200)	24	1949900000	1950140000
16	76.20	(3.000)	18	1949940000	1950180000

IL WMF 2.5 BLZ OR



Ordering data

Type	Qty.	Order No.
IL WMF 2.5 BLZ O	50	1167440000

WAD WMF 2.5



Ordering data

Type	Qty.	Order No.
WAD WMF 2.5	50	1142970000

FUCR SW



Ordering data

Type	Qty.	Order No.
FUCR SW	10	1167630000
FUCR 10-36V SW	10	1167640000
FUCR 30-70V SW	10	1167650000
FUCR 60-150V SW	10	1167670000
FUCR 100-250V SW	10	1167680000

AP WMF 2.5



Ordering data

Type	Qty.	Order No.
AP WMF 2.5	50	1142990000

WBB WMF 2.5 BLZ

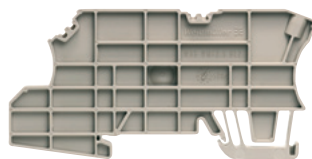

Ordering data

Type	Qty.	Order No.
WBB WMF 2.5 BLZ	10	1142980000

Thermocouple terminals

WDU 2.5/TC

2.5 mm²

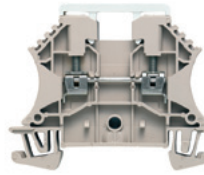

In hazardous area applications, the installation instructions and the rated data specifications for accessories given in the technical appendix must be followed.

Width/Length/Height of lowest version	mm
max. current / max. cond. cross-section	A/mm ²
Max. clamping range	mm ²

10.2 x 60 x 50.5
/ 2.5
0.13...2.5

Technical data

Rated data	
Rated voltage	V
Rated current	A
Rated cross-section	mm ²
Rated impulse withstand voltage / Pollution severity Gauge to IEC 60947-1 / Flammability class UL94	
Approvals	
Clamped conductors (H05V/H07V)	
Solid / stranded	mm ²
Flexible / Flexible with ferrule	mm ²
Tightening torque range (terminal screw)	
Stripping length / Blade size	mm/-
2 conductors with same cross-section (H05V/H07V)	
Solid / stranded	mm ²
Flexible / Flexible with ferrule	mm ²
Note	

IEC 60584, IEC 60947-7-1				Ex e II II 2 G D	
IEC	UL	CSA	EN 60079-7		
			55		
			1		
2.5			2.5		
			/ 3		
			A2 / V-0		
			SIRA 02ATEX3153 U		
Rated connection					
0.5...2.5 / 1.5...2.5					
0.5...2.5 / 0.5...2.5					
0.4...0.6 Nm (M 2.5)					
10 / 0.6 x 3.5 mm					
Rated connection					
0.5...1.5					
0.5...1.5 / 0.5...1.5					

Ordering data

Version	
	(NiCr - Ni) type K
	(Cu - CuNi) type T
	(Fe-CuNi) type J
	(Pt 10% - Pt Rh / Pt 13% - Pt Rh) type SR
	(Pt 10% Rh - Pt 6% Rh) type B
	(NiCr - CuNi) type E
	(NiSi - Nicrosil) type N
Note	

Type	Qty.	Order No.
WDU 2.5/TC TYP K	50	1024100000
WDU 2.5/TC TYP T	50	1024200000
WDU 2.5/TC TYP J	50	1024300000
WDU 2.5/TC TYP SR	50	1024400000
WDU 2.5/TC TYP B	50	1033700000
WDU 2.5/TC TYP E	50	1033300000
WDU 2.5/TC TYP N	50	1041500000

Accessories

End plate / Partition plate	
	Dark beige Wemid
	Dark beige Wemid
End bracket	
	Dark beige Wemid

Type	Width	Qty.	Order No.
WAP 2.5-10	1.5 mm	50	1050000000
WAP 16+35 WTW 2.5-10	1.5 mm	20	1050100000
WEW 35/2	8 mm	100	1061200000

Identification systems	(see assortment in catalogue 7)
	Marking tags
Note	

DEK 5/5

Weidmüller thermocouple terminals are specially designed for the transmission of very small voltages in temperature measuring circuits. Special current bars ensure that no false signals are transmitted within the terminal when temperature differences between the positive and negative paths exist. This high measuring precision is required, for example, in aircraft engine test rigs, complicated chemical processes, controllers, etc.

- Material of current bar corresponds to thermal and compensating conductors
- Clear thermocouple marking
- 2-pole blocks per thermocouple
- Modular width 10 mm

Configuration of a temperature measuring circuit

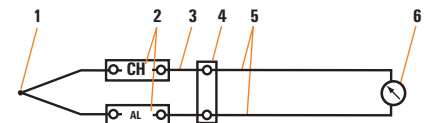

- | | |
|--------------------------|--------------------------------|
| 1 Thermocouple (sensor) | 4 Reference junction |
| 2 Thermocouple terminals | 5 Supply and return conductors |
| 3 Compensating conductor | 6 Measuring instrument |

The thermocouple terminals shown in this measuring circuit are used for the thermoelectrical transmission of the thermoelectric voltage from the thermocouple to the reference junction and the indicator unit via the compensating conductor.

Thermocouple terminals are required for constructing a temperature measuring circuit.

Technical data

Thermocouples to IEC 584 (DIN 43 710)

Current bar	
Cromel Alumel	
E-grade copper Constantan	
Iron Constantan	
E-grade copper/ A-grade copper	
S-grade copper/ E-grade copper	
Cromel- Constantan	

Modular terminals with electronic components are available for a number of standard applications. Other versions to customer specification are available upon request.

In hazardous area applications, the installation instructions and the rated data specifications for accessories given in the technical appendix must be followed.

Width/Length/Height of lowest version	mm
max. current / max. cond. cross-section	A/mm ²
Max. clamping range	mm ²

Technical data

Rated data	
Rated voltage	V
Rated current	A
Rated cross-section	mm ²
Rated impulse withstand voltage / Pollution severity	
Gauge to IEC 60947-1 / Flammability class UL94	
Approvals	
Clamped conductors (H05V/H07V)	
Solid / stranded	mm ²
Flexible / Flexible with ferrule	mm ²
Tightening torque range (terminal screw)	
Stripping length / Blade size	
mm/-	
2 conductors with same cross-section (H05V/H07V)	
Solid / stranded	mm ²
Flexible / Flexible with ferrule	mm ²
Note	

Ordering data

Version	Dark beige Wemid
Note	

Accessories

Intermediate frame	Thickness 2,5 mm
Busbar	1 m

Identification systems	(see assortment in catalogue 7) Marking tags
Note	

WPO 4

4 mm²

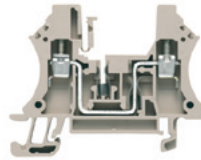

6 x 60 x 47	
32 / 4	
0.13...4	

IEC 60947-7-1		
IEC	UL	CSA
250	300 (D)	300 (D)
32	10 (D)	10 (D)
4	AWG 26...12	AWG 26...12
4 kV / 3		
A3 / V-0		
Rated connection		
0.5...4		
0.5...4 / 0.5...2.5		
0.5...1 Nm (M 3)		
8 / 0.6 x 3.5 mm		
0.5...1.5		
0.5...1.5		
The tightening torque is 2 Nm when connecting two conductors.		

Type	Qty.	Order No.
WPO 4	50	1036000000

Type	Width	Qty.	Order No.
ZR WPO4 DB	2.5 mm	20	1071100000
SSCH 7.3X1.2X1000	7.3 mm	1	1071200000

DEK 5/6 / WS 12/5

WPO 4 with varistor

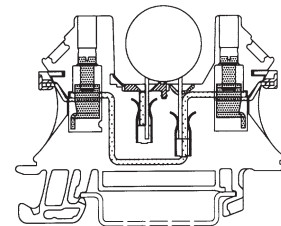

Weidmüller varistor terminals have been designed for the retrofitting of electronic components, e.g. varistors, diodes, gas discharge tubes, etc. These "electronic terminals" no longer have to be configured prior to installation for subsequent delivery with soldered components which can no longer be distinguished.

The significant advantages of this design are:

- **Cost saving:** Components can be changed quickly on site. Service requires only a visual inspection.
- **Clarity:** Components are easy to distinguish.
- **Flexibility:** Components can immediately be adapted to changed conditions.

Note: Never change electronic components under load!

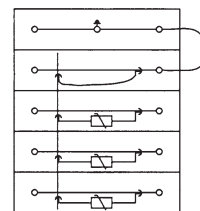

Overvoltages in a 3-phase supply discharged to earth via WPE 4 with the aid of varistors and a gas discharge tube.

Terminals with electronic components

Modular terminals with electronic components are available for a number of standard applications. Other versions to customer specification are available upon request.

In hazardous area applications, the installation instructions and the rated data specifications for accessories given in the technical appendix must be followed.

Width/Length/Height of lowest version	mm
max. current / max. cond. cross-section	A/mm ²
Max. clamping range	mm ²

Technical data

Rated data	
Rated cross-section	mm ²
Gauge to IEC 60947-1 / Flammability class UL94	
Approvals	
Clamped conductors (H05V/H07V)	
Solid / stranded	mm ²
Flexible / Flexible with ferrule	mm ²
Tightening torque range (terminal screw)	
Stripping length / Blade size	mm/-

Note

Ordering data

Version	
	10 Ω
	10 kΩ
	100 Ω
	500 Ω
	1 kΩ
	5 kΩ
	50 kΩ
	500 kΩ
	Without potentiometer

Note

Accessories

End plate / Partition plate	
	Dark beige Wemid
	Dark beige Wemid
End bracket	
	Dark beige Wemid
	Dark beige Wemid
Screwdriver	
	With "swifty set" cutting device
	Standard
Shield bus	

Identification systems (see assortment in catalogue 7)

Marking tags

Note

WDUL 4/...

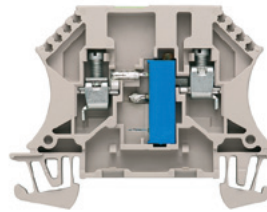
4 mm²

6.5 x 60 x 4.7
6 / 6
0.13...6

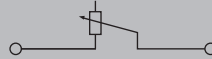

IEC 60947-7-1

IEC	UL	CSA
4		
A4 / V-0		

Rated connection	
	0.5...6 / 1.5...6
	0.5...4 / 0.5...2.5
	0.8 Nm (M 3)
	9 / 0.6 x 3.5 mm

Type	Qty.	Order No.
WDUL 4/10	10	1027000000
WDUL 4/10K	10	1027700000
WDUL 4/100	10	1027300000
WDUL 4/500	10	1027400000
WDUL 4/1K	10	1027500000
WDUL 4/5K	10	1027600000
WDUL 4/50K	10	1027800000
WDUL 4/500K	10	1028000000
WDUL 4	10	8161820000

Type	Width	Qty.	Order No.
WAP 2.5-10	1.5 mm	50	1050000000
WAP 16+35 WTW 2.5-10	1.5 mm	20	1050100000
WEW 35/2	8 mm	100	1061200000
EW 35	8.5 mm	50	0383560000
SWIFTY SET	18 mm	1	9006060000
SDS 0.6X3.5X100		1	9008330000
LS 2.8 WDU2.5-10	1.15 mm	100	1056400000

DEK 5/5

Technical data for the 30-Ω compensating resistor

Resistor material: "Cermet"

Resistor setting range: 0...30 Ω

Wave form: linear

Temperature coefficient: 100 ppm/°C

Mechanical lifespan: 200 operations without permissible deviations, across the entire resistance range

Resistance change per spindle turn: ≈ 1,2 Ω

Rated output for total resistance: 1 watt at 70 °C

Rated current: 120 mA

Ambient temperature: -55 °C to +70 °C

Ingress (seal) protection:

- 1) Leak tested in water at 70 °C without bubble formation
- 2) Storage in SFW 2.0 S, acc. to DIN 50018, 9 cycles

Capacity expressed in % of rated load

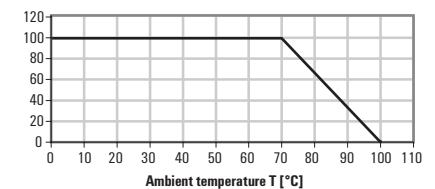

Modular terminals with electronic components are available for a number of standard applications. Other versions to customer specification are available upon request.

In hazardous area applications, the installation instructions and the rated data specifications for accessories given in the technical appendix must be followed.

Width/Length/Height of lowest version	mm
max. current / max. cond. cross-section	A/mm ²
Max. clamping range	mm ²

Technical data

Rated data	
Rated voltage	V
Rated current	A
Rated cross-section	mm ²
Rated impulse withstand voltage / Pollution severity Gauge to IEC 60947-1 / Flammability class UL94	
Approvals	
Electronic fixtures	
Component voltage / Component current	V/A
Operating voltage for display, max. / Current	V/A
Clamped conductors (H05V/H07V)	
Solid / stranded	mm ²
Flexible / Flexible with ferrule	mm ²
Tightening torque range (terminal screw)	
Stripping length / Blade size	mm/-
Note	

Ordering data

Version	
	Dark beige Wemid
	Dark beige Wemid (red LED)
	Dark beige Wemid (green LED)
Note	

Accessories

Screwable cross-connection	
	2-pole
	3-pole
	4-pole
	10-pole
End plate / Partition plate	
	Dark beige Wemid
End bracket	
	Dark beige Wemid
Screwdriver	
	With "swifty set" cutting device
	Standard

Identification systems	
	(see assortment in catalogue 7)
	Marking tags
Note	

WDK 2.5/D

2.5 mm²

Reverse polarity protection

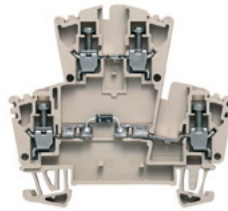

5.1 x 69 x 63
10 / 4
0.05...4

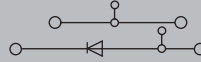

IEC 60947-7-1

IEC	UL	CSA
0	300 (C)	
10	1 (C)	
2.5	AWG 30...12	
6 kV / 3		
A3 / V-0		
UL		
1000 / 1		
Rated connection		
0.5...4 / 1.5...4		
0.5...4 / 0.5...2.5		
0.4...0.6 Nm (M 2.5)		
10 / 0.6 x 3.5 mm		
Rated current is 10 A for continuous busbars only. Diode 1 N 4007		

Type	Qty.	Order No.
WDK 2.5 1D	25	8025610000
2.5 mm ² wires with wire ferrules including the plastic collar only clampable with diameter-optimised collar (Order no. 1333100000, pack of 500).		

Type	current	Qty.	Order No.
WQV 2.5/2	32 A	50	1053660000
WQV 2.5/3	32 A	50	1053760000
WQV 2.5/4	32 A	50	1053860000
WQV 2.5/10	32 A	20	1054460000
Width			
WAP WDK2.5	1.5 mm	20	1059100000
WEW 35/2	8 mm	100	1061200000
SWIFTY SET	18 mm	1	9006060000
SDS 0.6X3.5X100		1	9008330000

DEK 5/5 / WS 8/5

WDK 2.5/D/1

2.5 mm²

Suppression circuit e. g. for contactor

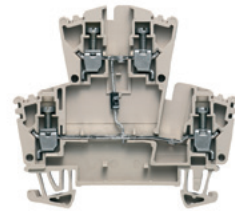

5.1 x 69 x 63
10 / 4
0.05...4

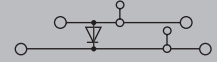

IEC 60947-7-1

IEC	UL	CSA
400	300 (C)	300 (C)
10	1 (C)	1 (C)
2.5	AWG 30...12	AWG 26...12
6 kV / 3		
A3 / V-0		
UL		
1000 / 1		
Rated connection		
0.5...4 / 1.5...4		
0.5...4 / 0.5...2.5		
0.4...0.6 Nm (M 2.5)		
10 / 0.6 x 3.5 mm		
Rated current is 10 A for continuous busbars only. Diode 1 N 4007		

Type	Qty.	Order No.
WDK 2.5 1D A.1	25	1023400000
2.5 mm ² wires with wire ferrules including the plastic collar only clampable with diameter-optimised collar (Order no. 1333100000, pack of 500).		

Type	current	Qty.	Order No.
WQV 2.5/2	32 A	50	1053660000
WQV 2.5/3	32 A	50	1053760000
WQV 2.5/4	32 A	50	1053860000
WQV 2.5/10	32 A	20	1054460000
Width			
WAP WDK2.5	1.5 mm	20	1059100000
WEW 35/2	8 mm	100	1061200000
SWIFTY SET	18 mm	1	9006060000
SDS 0.6X3.5X100		1	9008330000

DEK 5/5 / WS 8/5

Terminals with electronic components

Modular terminals with electronic components are available for a number of standard applications. Other versions to customer specification are available upon request.

In hazardous area applications, the installation instructions and the rated data specifications for accessories given in the technical appendix must be followed.

Width/Length/Height of lowest version	mm
max. current / max. cond. cross-section	A/mm ²
Max. clamping range	mm ²

Technical data

Rated data	
Rated voltage	V
Rated current	A
Rated cross-section	mm ²
Rated impulse withstand voltage / Pollution severity	
Gauge to IEC 60947-1 / Flammability class UL94	
Approvals	
Electronic fixtures	
Component voltage / Component current	V/A
Operating voltage for display, max. / Current	V/A
Clamped conductors (H05V/H07V)	
Solid / stranded	mm ²
Flexible / Flexible with ferrule	mm ²
Tightening torque range (terminal screw)	
Stripping length / Blade size	mm/-
Note	

Ordering data

Version	
	Dark beige Wemid
	Dark beige Wemid (red LED)
	Dark beige Wemid (green LED)
Note	

Accessories

Screwable cross-connection	
	2-pole
	3-pole
	4-pole
	10-pole
End plate / Partition plate	
	Dark beige Wemid
End bracket	
	Dark beige Wemid
Screwdriver	
	With "swifty set" cutting device
	Standard

Identification systems	
	(see assortment in catalogue 7)
	Marking tags
Note	

WDK 2.5/D/2

2.5 mm²

Suppression circuit e. g. for contactor

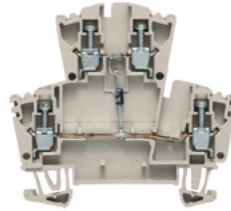

5.1 x 69 x 63
10 / 4
0.05...4



IEC 60947-7-1

IEC	UL	CSA
400	300 (C)	300 (C)
10	1 (C)	1 (C)
2.5	AWG 30...12	AWG 26...12
6 kV / 3		
A3 / V-0		



1000 / 1

Rated connection

0.5...4 / 1.5...4
0.5...4 / 0.5...2.5
0.4...0.6 Nm (M 2.5)
10 / 0.6 x 3.5 mm

Rated current is 10 A for continuous busbars only. Diode 1 N 4007

Type	Qty.	Order No.
WDK 2.5 1D A.2	25	1023300000

2.5 mm² wires with wire ferrules including the plastic collar only clampable with diameter-optimised collar (Order no. 1333100000, pack of 500).

Type	current	Qty.	Order No.
WQV 2.5/2	32 A	50	1053660000
WQV 2.5/3	32 A	50	1053760000
WQV 2.5/4	32 A	50	1053860000
WQV 2.5/10	32 A	20	1054460000
Width			
WAP WDK2.5	1.5 mm	20	1059100000
WEW 35/2	8 mm	100	1061200000
SWIFTY SET	18 mm	1	9006060000
SDS 0.6X3.5X100		1	9008330000

Identification systems	
	(see assortment in catalogue 7)
	Marking tags
Note	

DEK 5/5 / WS 8/5

WDK 2.5/D/4

2.5 mm²

Lamp test circuits

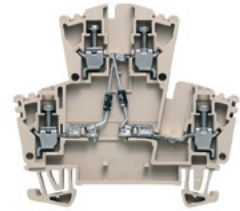

5.1 x 69 x 63
10 / 4
0.05...4

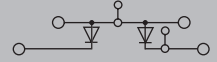

IEC 60947-7-1

IEC	UL	CSA
400		
10		
2.5		
6 kV / 3		
A3 / V-0		

1000 / 1

Rated connection

0.5...4 / 1.5...4
0.5...4 / 0.5...2.5
0.4...0.6 Nm (M 2.5)
10 / 0.6 x 3.5 mm

Rated current is 10 A for continuous busbars only. Diode 1 N 4007

Type	Qty.	Order No.
WDK 2.5 2D 1.A	25	8014670000

2.5 mm² wires with wire ferrules including the plastic collar only clampable with diameter-optimised collar (Order no. 1333100000, pack of 500).

Type	current	Qty.	Order No.
WQV 2.5/2	32 A	50	1053660000
WQV 2.5/3	32 A	50	1053760000
WQV 2.5/4	32 A	50	1053860000
WQV 2.5/10	32 A	20	1054460000
Width			
WAP WDK2.5	1.5 mm	20	1059100000
WEW 35/2	8 mm	100	1061200000
SWIFTY SET	18 mm	1	9006060000
SDS 0.6X3.5X100		1	9008330000

Identification systems	
	(see assortment in catalogue 7)
	Marking tags
Note	

DEK 5/5 / WS 8/5

WDK 2.5/D/5

2.5 mm²

Lamp test circuits

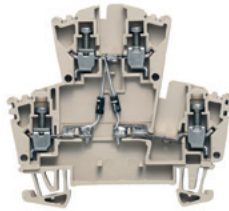

5.1 x 69 x 63
10 / 4
0.05...4



IEC 60947-7-1

IEC	UL	CSA
400	300 (C)	300 (D)
10	1 (C)	10 (D)
2.5	AWG 30...12	AWG 26...12
6 kV / 3		
A3 / V-0		



1000 / 1

Rated connection

0.5...4 / 1.5...4
0.5...4 / 0.5...2.5
0.4...0.6 Nm (M 2.5)
10 / 0.6 x 3.5 mm

Rated current is 10 A for continuous busbars only. Diode 1 N 4007

Type	Qty.	Order No.
WDK 2.5 2D 2.A	25	1022600000

2.5 mm² wires with wire ferrules including the plastic collar only clampable with diameter-optimised collar (Order no. 1333100000, pack of 500).

Type	current	Qty.	Order No.
WQV 2.5/2	32 A	50	1053660000
WQV 2.5/3	32 A	50	1053760000
WQV 2.5/4	32 A	50	1053860000
WQV 2.5/10	32 A	20	1054460000
Width			
WAP WDK2.5	1.5 mm	20	1059100000
WEW 35/2	8 mm	100	1061200000
SWIFTY SET	18 mm	1	9006060000
SDS 0.6X3.5X100		1	9008330000

DEK 5/5 / WS 8/5

WDK 2.5/D/6

2.5 mm²

Lamp test circuits

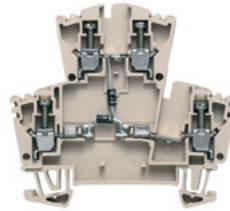

5.1 x 69 x 63
10 / 4
0.05...4

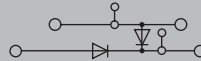

IEC 60947-7-1

IEC	UL	CSA
400		300 (C)
10		10 (C)
2.5		AWG 26...12
6 kV / 3		
A3 / V-0		



1000 / 1

Rated connection

0.5...4 / 1.5...4
0.5...4 / 0.5...2.5
0.4...0.6 Nm (M 2.5)
10 / 0.6 x 3.5 mm

Rated current is 10 A for continuous busbars only.

Type	Qty.	Order No.
WDK 2.5 2D	25	1023500000

2.5 mm² wires with wire ferrules including the plastic collar only clampable with diameter-optimised collar (Order no. 1333100000, pack of 500).

Type	current	Qty.	Order No.
WQV 2.5/2	32 A	50	1053660000
WQV 2.5/3	32 A	50	1053760000
WQV 2.5/4	32 A	50	1053860000
WQV 2.5/10	32 A	20	1054460000
Width			
WAP WDK2.5	1.5 mm	20	1059100000
WEW 35/2	8 mm	100	1061200000
SWIFTY SET	18 mm	1	9006060000
SDS 0.6X3.5X100		1	9008330000

DEK 5/5 / WS 8/5

WDK 2.5/D

2.5 mm²

For installing electronic components

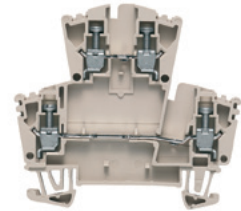

5.1 x 69 x 63
10 / 4
0.05...4

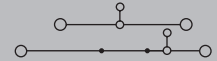

IEC 60947-7-1

IEC	UL	CSA
400	300 (C)	
10	1 (C)	
2.5	AWG 30...12	
6 kV / 3		
A3 / V-0		



1000 / 1

Rated connection

0.5...4 / 1.5...4
0.5...4 / 0.5...2.5
0.4...0.6 Nm (M 2.5)
10 / 0.6 x 3.5 mm

Rated current is 10 A for continuous busbars only.

Type	Qty.	Order No.
WDK 2.5/D	100	1023200000

2.5 mm² wires with wire ferrules including the plastic collar only clampable with diameter-optimised collar (Order no. 1333100000, pack of 500).

Type	current	Qty.	Order No.
WQV 2.5/2	32 A	50	1053660000
WQV 2.5/3	32 A	50	1053760000
WQV 2.5/4	32 A	50	1053860000
WQV 2.5/10	32 A	20	1054460000
Width			
WAP WDK2.5	1.5 mm	20	1059100000
WEW 35/2	8 mm	100	1061200000
SWIFTY SET	18 mm	1	9006060000
SDS 0.6X3.5X100		1	9008330000

DEK 5/5 / WS 8/5

Terminals with electronic components

In hazardous area applications, the installation instructions and the rated data specifications for accessories given in the technical appendix must be followed.

Width/Length/Height of lowest version	mm
max. current / max. cond. cross-section	A/mm ²
Max. clamping range	mm ²

Technical data

Rated data	
Rated voltage	V
Rated current	A
Rated cross-section	mm ²
Rated impulse withstand voltage / Pollution severity	
Gauge to IEC 60947-1 / Flammability class UL94	
Approvals	
Electronic fixtures	
Component voltage / Component current	V/A
Operating voltage for display, max. / Current	V/mA
Clamped conductors (H05V/H07V)	
Solid / stranded	mm ²
Flexible / Flexible with ferrule	mm ²
Tightening torque range (terminal screw)	
Stripping length / Blade size	mm/-
Note	

Ordering data

Version	
	Dark beige Wemid
	Dark beige Wemid (red LED)
	Dark beige Wemid (green LED)
Note	

Accessories

Screwable cross-connection	
	2-pole
	3-pole
	4-pole
	10-pole
End plate / Partition plate	
	Dark beige Wemid
End bracket	
	Dark beige Wemid
Screwdriver	
	With "swifty set" cutting device
	Standard

Identification systems	(see assortment in catalogue 7)
	Marking tags
Note	

WDK 2.5 LD +-

2.5 mm²

DC voltage indicator + / -

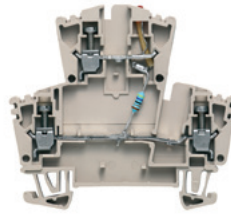

5.1 x 69 x 63
10 / 4
0.13...4

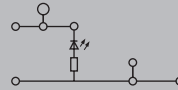

IEC 60947-7-1

IEC	UL	CSA
24		
2.5		
	0.8 kV / 3	
	A3 / V-0	
24 / 5		
Rated connection		
0.5...4 / 1.5...4		
0.5...4 / 0.5...2.5		
0.4...0.6 Nm (M 2.5)		
10 / 0.6 x 3.5 mm		
Note		

Type	Qty.	Order No.
WDK 2.5 LD RT 24VDC +-	25	1023600000
WDK 2.5 LD/GN 1R 24VDC	25	8023610000
2.5 mm ² wires with wire ferrules including the plastic collar only clampable with diameter-optimised collar (Order no. 1333100000, pack of 500).		

Type	current	Qty.	Order No.
WQV 2.5/2	32 A	50	1053660000
WQV 2.5/3	32 A	50	1053760000
WQV 2.5/4	32 A	50	1053860000
WQV 2.5/10	32 A	20	1054460000
Width			
WAP WDK2.5	1.5 mm	20	1059100000
WEW 35/2	8 mm	100	1061200000
SWIFTY SET	18 mm	1	9006060000
SDS 0.6X3.5X100		1	9008330000

WDK 2.5 LD - +

2.5 mm²

DC voltage indicator - / +

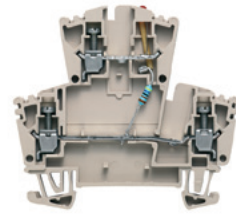

5.1 x 69 x 63
10 / 4
0.13...4

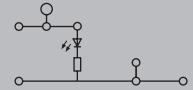

IEC 60947-7-1

IEC	UL	CSA
24		
2.5		
	0.8 kV / 3	
	A3 / V-0	
24 / 5		
Rated connection		
0.5...4 / 1.5...4		
0.5...4 / 0.5...2.5		
0.4...0.6 Nm		
10 / 0.6 x 3.5 mm		
Note		

Type	Qty.	Order No.
WDK 2.5 LD RT 24VDC - +	25	8023630000
WDK 2.5 LD GR 1R 24VDC	25	8010040000
2.5 mm ² wires with wire ferrules including the plastic collar only clampable with diameter-optimised collar (Order no. 1333100000, pack of 500).		

Type	current	Qty.	Order No.
WQV 2.5/2	32 A	50	1053660000
WQV 2.5/3	32 A	50	1053760000
WQV 2.5/4	32 A	50	1053860000
WQV 2.5/10	32 A	20	1054460000
Width			
WAP WDK2.5	1.5 mm	20	1059100000
WEW 35/2	8 mm	100	1061200000
SWIFTY SET	18 mm	1	9006060000
SDS 0.6X3.5X100		1	9008330000

Identification systems	(see assortment in catalogue 7)
	Marking tags
Note	

Power distribution blocks WPDB

- Space-saving design
- Modular or 3-phase block versions
- Easy to use
- IP20 class of protection
- For TS 35 rail or direct mounting
- High short-circuit protection
- Parallel cross-connection with 15 x 5 mm busbar

WPDB 16/6 3/4

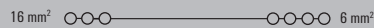
16/6 mm²

WPDB 35-16/16 1-1/6

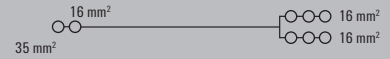
35/6 mm²

Technical data

Technical data	
Max. current	
Dimensions	
Width / Length / Height (mm)	with TS 35 x 7.5
Weight	
IEC rated 60 947-7-1	
Rated voltage	V
Rated current	A
Rated cross-section in-/output	mm ²
Rated impulse voltage / Pollution severity	
UL94 Flammability Class	
Further technical data	
Short-circuit strength (peak value)	kA
Short-circuit strength > 1 s	kA
Inputs	
No. of connections	
Clampable conductors:	
„e“ solid H07V-U	mm ²
„m“ stranded H07V-R	mm ²
„f“ flexible H07V-K	mm ²
„f“ flexible H07V-K and ferrule acc. to DIN 46 228/1	mm ²
„f“ flexible H07V-K and ferrule with plastic insul. collar	mm ²
Diameter	mm
Tightening torque	Nm
Clamping screw	
Blade size	
Stripping length	mm
Outputs	
No. of connections	
Clampable conductors:	
„e“ solid H07V-U	mm ²
„m“ stranded H07V-R	mm ²
„f“ flexible H07V-K	mm ²
„f“ flexible H07V-K and ferrule acc. to DIN 46 228/1	mm ²
„f“ flexible H07V-K and ferrule with plastic insul. collar	mm ²
Diameter	mm
Tightening torque	Nm
Clamping screw	
Blade size	
Stripping length	mm
UL/CSA rated data	
Voltage/current/conductor size	UL
Voltage/current/conductor size	CSA

Technical data			
Max. current	80 A		
Dimensions			
Width / Length / Height (mm)	27 x 66 x 47 (50)		
Weight	63 g		
IEC rated 60 947-7-1			
Rated voltage	690		
Rated current	80		
Rated cross-section in-/output	16 / 16-6		
Rated impulse voltage / Pollution severity	2.5 KV / 3		
UL94 Flammability Class	V-0		
Further technical data			
Short-circuit strength (peak value)	22		
Short-circuit strength > 1 s	3		
Inputs	A	B	C
No. of connections	1		
Clampable conductors:			
„e“ solid H07V-U	2.5 ... 16		
„m“ stranded H07V-R	2.5 ... 16		
„f“ flexible H07V-K	2.5 ... 16		
„f“ flexible H07V-K and ferrule acc. to DIN 46 228/1	2.5 ... 16		
„f“ flexible H07V-K and ferrule with plastic insul. collar	2.5 ... 16		
Diameter	7		
Tightening torque	1.5 ... 3		
Clamping screw	M5		
Blade size	PZ2		
Stripping length	12 ... 18		
Outputs	A	B	C
No. of connections	2	4	
Clampable conductors:			
„e“ solid H07V-U	2.5 ... 16	2.5 ... 6	
„m“ stranded H07V-R	2.5 ... 16	2.5 ... 6	
„f“ flexible H07V-K	2.5 ... 16	2.5 ... 6	
„f“ flexible H07V-K and ferrule acc. to DIN 46 228/1	2.5 ... 16	2.5 ... 6	
„f“ flexible H07V-K and ferrule with plastic insul. collar	2.5 ... 16	2.5 ... 6	
Diameter	7	4.5	
Tightening torque	1.5 ... 3	0.8 ... 1.5	
Clamping screw	M5	M4	
Blade size	PZ2	PZ1	
Stripping length	9 ... 12	12 ... 18	
UL/CSA rated data			
Voltage/current/conductor size			
Voltage/current/conductor size			

Technical data			
Max. current	125 A		
Dimensions			
Width / Length / Height (mm)	27 x 74 x 47 (50)		
Weight	134 g		
IEC rated 60 947-7-1			
Rated voltage	690		
Rated current	125		
Rated cross-section in-/output	35-16 / 16		
Rated impulse voltage / Pollution severity	2.5 KV / 3		
UL94 Flammability Class	V-0		
Further technical data			
Short-circuit strength (peak value)	30		
Short-circuit strength > 1 s	4.2		
Inputs	A	B	C
No. of connections	1	1	
Clampable conductors:			
„e“ solid H07V-U	10 ... 35	2.5 ... 16	
„m“ stranded H07V-R	10 ... 35	2.5 ... 16	
„f“ flexible H07V-K	10 ... 35	2.5 ... 16	
„f“ flexible H07V-K and ferrule acc. to DIN 46 228/1	10 ... 35	2.5 ... 16	
„f“ flexible H07V-K and ferrule with plastic insul. collar	10 ... 35	2.5 ... 16	
Diameter	10	7	
Tightening torque	3.5 ... 5	3.5 ... 5	
Clamping screw	M8	M6	
Blade size	M4	M4	
Stripping length	14 ... 15	10 ... 12	
Outputs	A	B	C
No. of connections	6		
Clampable conductors:			
„e“ solid H07V-U	2.5 ... 16		
„m“ stranded H07V-R	2.5 ... 16		
„f“ flexible H07V-K	2.5 ... 16		
„f“ flexible H07V-K and ferrule acc. to DIN 46 228/1	2.5 ... 16		
„f“ flexible H07V-K and ferrule with plastic insul. collar	2.5 ... 16		
Diameter	6.5		
Tightening torque	2 ... 3		
Clamping screw	M5		
Blade size	PZ2		
Stripping length	10 ... 12		
UL/CSA rated data			
Voltage/current/conductor size			
Voltage/current/conductor size			

Ordering data

Version	
	dark beige Wemid

Type	Qty.	Order No.
WPDB 16/6 3/4	1	1939440000

Type	Qty.	Order No.
WPDB 35-16/16 1-1/6	1	1939450000

Accessories

Screwdrivers	
	Crosshead screwdriver, Pozidriv type
	Crosshead screwdriver, Pozidriv type
	7-piece hexagon wrench set
Labelling systems	
	Marking labels

Type	Qty.	Order No.
SDK PZ1	1	9008530000
SDK PZ2	1	9008540000
SK-S 2.0-8.0	1	9008860000
LM MT300 15 x 9 GE	1	1882890000

Type	Qty.	Order No.
SDK PZ2	1	9008540000
SK-S 2.0-8.0	1	9008860000
LM MT300 15 x 9 GE	1	1882890000

WPDB 70/16 1/10

70/16 mm²

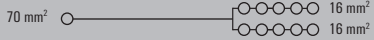

175 A

45 x 71 x 43 (46)

228 g

690

175

70 / 16

2.5 KV / 3

V-0

22

3

A B C

1

16 ... 70

16 ... 70

16 ... 50

16 ... 50

16 ... 50

12

5

M10

M5

15 ... 16

A B C

10

2.5 ... 16

2.5 ... 16

2.5 ... 16

2.5 ... 16

2.5 ... 16

6

3

M6

M3

10 ... 12

Type	Qty.	Order No.
WPDB 70/16 1/10	1	1939460000

Type	Qty.	Order No.
SK-S 2.0-8.0	1	9008860000

LM MT300 15 x 9 GE	1	1882890000
--------------------	---	------------

WPDB 16/6 3/4

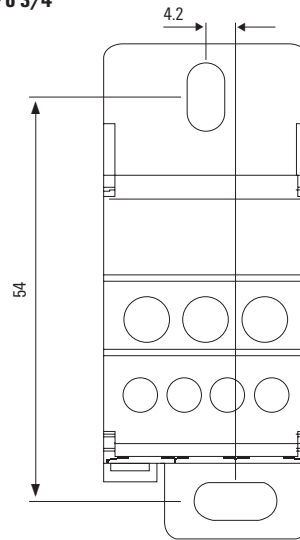

WPDB 35-16/16 1-1/6

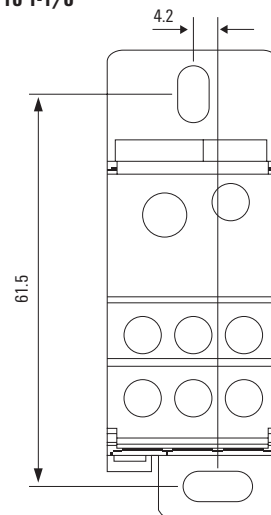

WPDB 70/16 1/10

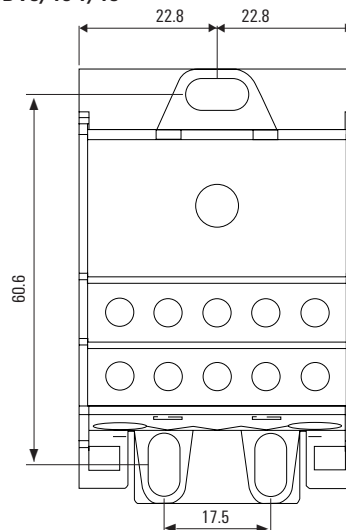

Power distribution blocks WPDB

- Space-saving design
- Modular or 3-phase block versions
- Easy to use
- IP20 class of protection
- For TS 35 rail or direct mounting
- High short-circuit protection
- Parallel cross-connection with 15 x 5 mm busbar

WPDB 120/35-16-10 1/2-5-4

120/35 mm²

WPDB 185/35-16-10 1/2-5-4

185/35 mm²

Technical data

Max. current	
250 A	
Dimensions	
Width / Length / Height (mm)	with TS 35 x 7.5
Weight	434 g
IEC rated 60 947-7-1	
Rated voltage	V 690
Rated current	A 250
Rated cross-section in-/output	mm ² 120 / 35-16-10
Rated impulse voltage / Pollution severity	2.5 KV / 3
UL94 Flammability Class	V-0
Further technical data	
Short-circuit strength (peak value)	kA 51
Short-circuit strength > 1 s	kA 24.5
Inputs	
No. of connections	1
Clampable conductors:	
„e“ solid H07V-U	mm ² 35 ... 120
„m“ stranded H07V-R	mm ² 35 ... 120
„f“ flexible H07V-K	mm ² 35 ... 120
„f“ flexible H07V-K and ferrule acc. to DIN 46 228/1	mm ² 35 ... 70
„f“ flexible H07V-K and ferrule with plastic insul. collar	mm ² 35 ... 70
Diameter	mm 15
Tightening torque	Nm 19
Clamping screw	M14
Blade size	M6
Stripping length	mm 27 ... 29
Outputs	
No. of connections	2
Clampable conductors:	
„e“ solid H07V-U	mm ² 6 ... 35
„m“ stranded H07V-R	mm ² 6 ... 35
„f“ flexible H07V-K	mm ² 6 ... 35
„f“ flexible H07V-K and ferrule acc. to DIN 46 228/1	mm ² 6 ... 25
„f“ flexible H07V-K and ferrule with plastic insul. collar	mm ² 6 ... 25
Diameter	mm 9
Tightening torque	Nm 3.5
Clamping screw	M8
Blade size	SD 1.0 x 5.5 x 150
Stripping length	mm 10 ... 12
UL/CSA rated data	
Voltage/current/conductor size	UL
Voltage/current/conductor size	CSA

Max. current		
250 A		
Dimensions		
44 x 96 x 50 (53)		
434 g		
IEC rated 60 947-7-1		
Rated voltage V 690		
Rated current A 250		
Rated cross-section in-/output mm ² 120 / 35-16-10		
Rated impulse voltage / Pollution severity 2.5 KV / 3		
UL94 Flammability Class V-0		
Further technical data		
Short-circuit strength (peak value) kA 51		
Short-circuit strength > 1 s kA 24.5		
Inputs		
No. of connections 1		
Clampable conductors:		
„e“ solid H07V-U mm ² 35 ... 120		
„m“ stranded H07V-R mm ² 35 ... 120		
„f“ flexible H07V-K mm ² 35 ... 120		
„f“ flexible H07V-K and ferrule acc. to DIN 46 228/1 mm ² 35 ... 70		
„f“ flexible H07V-K and ferrule with plastic insul. collar mm ² 35 ... 70		
Diameter mm 15		
Tightening torque Nm 19		
Clamping screw M14		
Blade size M6		
Stripping length mm 27 ... 29		
Outputs		
No. of connections 2		
Clampable conductors:		
„e“ solid H07V-U mm ² 6 ... 35		
„m“ stranded H07V-R mm ² 6 ... 35		
„f“ flexible H07V-K mm ² 6 ... 35		
„f“ flexible H07V-K and ferrule acc. to DIN 46 228/1 mm ² 6 ... 25		
„f“ flexible H07V-K and ferrule with plastic insul. collar mm ² 6 ... 25		
Diameter mm 9		
Tightening torque Nm 3.5		
Clamping screw M8		
Blade size SD 1.0 x 5.5 x 150		
Stripping length mm 10 ... 12		
UL/CSA rated data		
Voltage/current/conductor size UL		
Voltage/current/conductor size CSA		

Max. current		
400 A		
Dimensions		
44 x 96 x 50 (53)		
414 g		
IEC rated 60 947-7-1		
Rated voltage V 690		
Rated current A 400		
Rated cross-section in-/output mm ² 185 / 35-16-10		
Rated impulse voltage / Pollution severity 2.5 KV / 3		
UL94 Flammability Class V-0		
Further technical data		
Short-circuit strength (peak value) kA 51		
Short-circuit strength > 1 s kA 24.5		
Inputs		
No. of connections 1		
Clampable conductors:		
„e“ solid H07V-U mm ² 95 ... 185		
„m“ stranded H07V-R mm ² 95 ... 185		
„f“ flexible H07V-K mm ² 95 ... 185		
„f“ flexible H07V-K and ferrule acc. to DIN 46 228/1 mm ² 95 ... 120		
„f“ flexible H07V-K and ferrule with plastic insul. collar mm ² 95 ... 120		
Diameter mm 19		
Tightening torque Nm 25		
Clamping screw M16		
Blade size M8		
Stripping length mm 27 ... 29		
Outputs		
No. of connections 2		
Clampable conductors:		
„e“ solid H07V-U mm ² 6 ... 35		
„m“ stranded H07V-R mm ² 6 ... 35		
„f“ flexible H07V-K mm ² 6 ... 35		
„f“ flexible H07V-K and ferrule acc. to DIN 46 228/1 mm ² 6 ... 25		
„f“ flexible H07V-K and ferrule with plastic insul. collar mm ² 6 ... 25		
Diameter mm 9		
Tightening torque Nm 3.5		
Clamping screw M8		
Blade size SD 1.0 x 5.5 x 150		
Stripping length mm 10 ... 12		
UL/CSA rated data		
Voltage/current/conductor size UL		
Voltage/current/conductor size CSA		

Ordering data

Version
dark beige Wemid

Type	Qty.	Order No.
WPDB 120/35-16-10 1/2-5-4	1	1939470000

Type	Qty.	Order No.
WPDB 185/35-16-10 1/2-5-4	1	1939480000

Accessories

Screwdrivers	
Crosshead screwdriver, Pozidriv type	
Crosshead screwdriver, Pozidriv type	
7-piece hexagon wrench set	
Labelling systems	
Marking labels	

Type	Qty.	Order No.
SD 1.0 x 5.5 x 150	1	9008350000
SD 0.8 x 4.5 x 125	1	9009020000
SK-S 2.0-8.0	1	9008860000
LM MT300 15 x 9 GE	1	1882890000

Type	Qty.	Order No.
SD 1.0 x 5.5 x 150	1	9008350000
SD 0.8 x 4.5 x 125	1	9009020000
SK-S 2.0-8.0	1	9008860000
LM MT300 15 x 9 GE	1	1882890000

WPDB 3 x 70/16 1/6

70/16 mm²

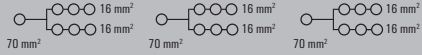

175 A

71 x 74 x 43 (46)

386 g

690

175

70 / 16

2.5 KV / 3

V-0

A	B	C
---	---	---

3 x 1

16 ... 70

16 ... 70

16 ... 70

16 ... 50

16 ... 50

12

5

M10

M5

15 ... 16

A	B	C
---	---	---

3 x 6

2.5 ... 16

2.5 ... 16

2.5 ... 16

2.5 ... 16

2.5 ... 16

6

3

M6

M3

10 ... 12

Type	Qty.	Order No.
WPDB 3 x 70/16 1/6	1	1939490000

Type	Qty.	Order No.
------	------	-----------

SK-S 2.0-8.0 1 9008860000

LM MT300 15 x 9 GE 1 1882890000

WPDB 120/35-16-10 1/2-5-4

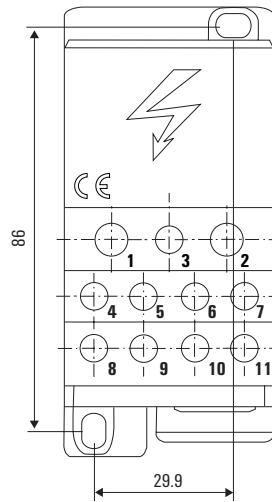

WPDB 185/35-16-10 1/2-5-4

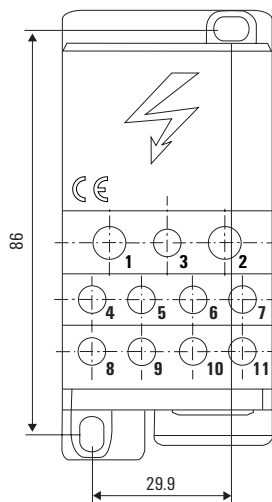

WPDB 3 x 70/16 1/6

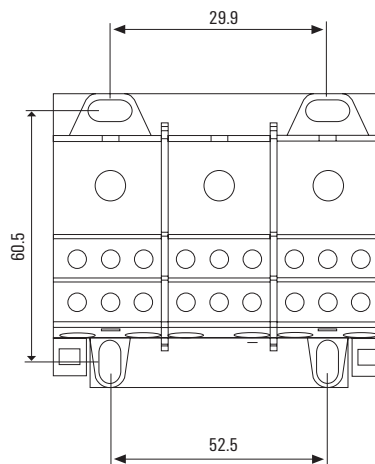

Power distribution blocks WPDB

- Space-saving design
- Modular or 3-phase block versions
- Easy to use
- IP20 class of protection
- For TS 35 rail or direct mounting
- High short-circuit protection
- Parallel cross-connection with 15 x 5 mm busbar

WPDB 70/16 1/6

70/16 mm²

With distribution for busbars (parallel connection)
15 x 5 mm

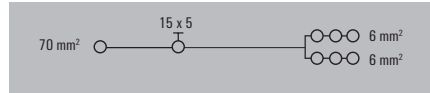

WPDB 35/16/6/N 1/2/5/11

35/16/6/N mm²

Three-phase power-supply block with neutral-conductor busbar

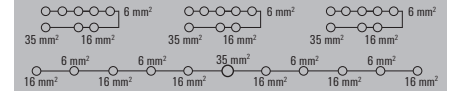

Technical data

Max. current	
Dimensions	
Width / Length / Height (mm)	with TS 35 x 7.5
Weight	
IEC rated 60 947-7-1	
Rated voltage	V
Rated current	A
Rated cross-section in-/output	mm ²
Rated impulse voltage / Pollution severity	
UL94 Flammability Class	
Further technical data	
Short-circuit strength (peak value)	kA
Short-circuit strength > 1 s	kA
Inputs	
No. of connections	
Clampable conductors:	
„e“ solid H07V-U	mm ²
„m“ stranded H07V-R	mm ²
„f“ flexible H07V-K	mm ²
„f“ flexible H07V-K and ferrule acc. to DIN 46 228/1	mm ²
„f“ flexible H07V-K and ferrule with plastic insul. collar	mm ²
Diameter	mm
Tightening torque	Nm
Clamping screw	
Blade size	
Stripping length	mm
Outputs	
No. of connections	
Clampable conductors:	
„e“ solid H07V-U	mm ²
„m“ stranded H07V-R	mm ²
„f“ flexible H07V-K	mm ²
„f“ flexible H07V-K and ferrule acc. to DIN 46 228/1	mm ²
„f“ flexible H07V-K and ferrule with plastic insul. collar	mm ²
Diameter	mm
Tightening torque	Nm
Clamping screw	
Blade size	
Stripping length	mm
UL/CSA rated data	
Voltage/current/conductor size	UL
Voltage/current/conductor size	CSA

Max. current	160 A	
Dimensions		
Width / Length / Height (mm)	35 x 92 x 50 (53)	
Weight	238 g	
IEC rated 60 947-7-1		
Rated voltage	690	
Rated current	160	
Rated cross-section in-/output	70 / 16	
Rated impulse voltage / Pollution severity	2.5 KV / 3	
UL94 Flammability Class	V-0	
Further technical data		
Short-circuit strength (peak value)	30	
Short-circuit strength > 1 s	11.8	
Inputs		
No. of connections		
Clampable conductors:		
„e“ solid H07V-U	mm ²	10 ... 70
„m“ stranded H07V-R	mm ²	10 ... 70
„f“ flexible H07V-K	mm ²	10 ... 70
„f“ flexible H07V-K and ferrule acc. to DIN 46 228/1	mm ²	10 ... 50
„f“ flexible H07V-K and ferrule with plastic insul. collar	mm ²	10 ... 50
Diameter	mm	13
Tightening torque	Nm	4
Clamping screw		M10
Blade size		M5
Stripping length	mm	19 ... 23
Outputs		
No. of connections		
Clampable conductors:		
„e“ solid H07V-U	mm ²	2.5 ... 16
„m“ stranded H07V-R	mm ²	2.5 ... 16
„f“ flexible H07V-K	mm ²	2.5 ... 16
„f“ flexible H07V-K and ferrule acc. to DIN 46 228/1	mm ²	2.5 ... 16
„f“ flexible H07V-K and ferrule with plastic insul. collar	mm ²	2.5 ... 16
Diameter	mm	6
Tightening torque	Nm	2
Clamping screw		M5
Blade size		PZ2
Stripping length	mm	10 ... 12
UL/CSA rated data		
Voltage/current/conductor size		
Voltage/current/conductor size		

Max. current	125 A	
Dimensions		
Width / Length / Height (mm)	98 x 74 x 50 (53)	
Weight	314 g	
IEC rated 60 947-7-1		
Rated voltage	690	
Rated current	125	
Rated cross-section in-/output	35 / 16	
Rated impulse voltage / Pollution severity	2.5 KV / 3	
UL94 Flammability Class	V-0	
Further technical data		
Short-circuit strength (peak value)	30	
Short-circuit strength > 1 s	11.8	
Inputs		
No. of connections		
Clampable conductors:		
„e“ solid H07V-U	mm ²	10 ... 35
„m“ stranded H07V-R	mm ²	10 ... 35
„f“ flexible H07V-K	mm ²	10 ... 35
„f“ flexible H07V-K and ferrule acc. to DIN 46 228/1	mm ²	10 ... 25
„f“ flexible H07V-K and ferrule with plastic insul. collar	mm ²	10 ... 25
Diameter	mm	9
Tightening torque	Nm	1.5
Clamping screw		M5
Blade size		PZ2
Stripping length	mm	12 ... 18
Outputs		
No. of connections		
Clampable conductors:		
„e“ solid H07V-U	mm ²	2.5 ... 35
„m“ stranded H07V-R	mm ²	2.5 ... 35
„f“ flexible H07V-K	mm ²	2.5 ... 35
„f“ flexible H07V-K and ferrule acc. to DIN 46 228/1	mm ²	2.5 ... 25
„f“ flexible H07V-K and ferrule with plastic insul. collar	mm ²	2.5 ... 25
Diameter	mm	6
Tightening torque	Nm	1.5
Clamping screw		M5
Blade size		PZ2
Stripping length	mm	12 ... 18
UL/CSA rated data		
Voltage/current/conductor size		
Voltage/current/conductor size		

Ordering data

Version	dark beige Wemid
----------------	------------------

Type	Qty.	Order No.
WPDB 70/16 1/6	1	1939500000

Type	Qty.	Order No.
WPDB 35/16/6/N 1/2/5/11	1	1939510000

Accessories

Screwdrivers	
Crosshead screwdriver, Pozidriv type	
Crosshead screwdriver, Pozidriv type	
7-piece hexagon wrench set	
Labelling systems	
Marking labels	

Type	Qty.	Order No.
SDK PZ2	1	9008540000
SK-S 2.0-8.0	1	9008860000
LM MT300 15 x 9 GE	1	1882890000

Type	Qty.	Order No.
SDK PZ1	1	9008530000
SDK PZ2	1	9008540000
LM MT300 15 x 9 GE	1	1882890000

WPDB 70/16 1/6

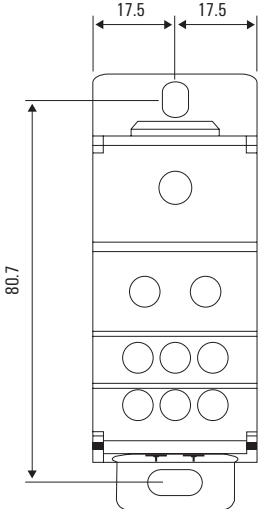

WPDB 35/16/6/N 1/2/5/11

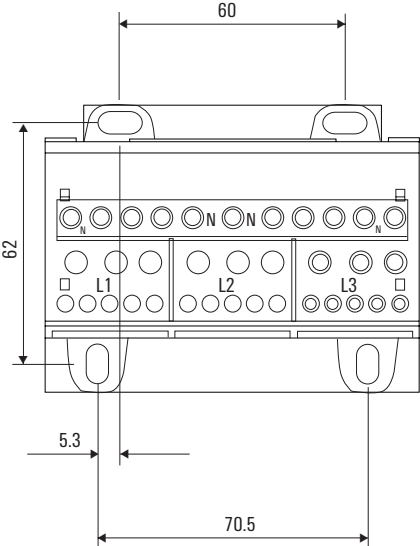

Assembly instructions

**WPDB 120/35-16-10 1/2-5-4 and
WPDB 185/35-16-10 1/2-5-4**

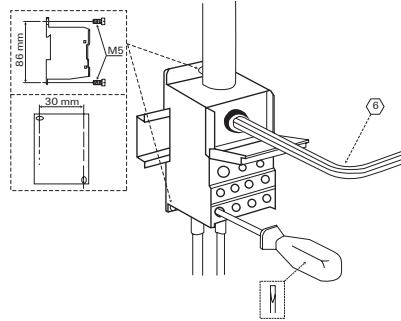

D WPDB 70/16 1/6

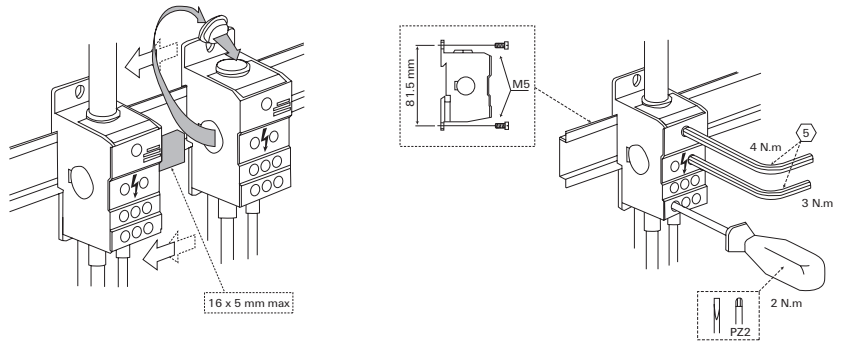

WPDB 35-16/16 1-1/6

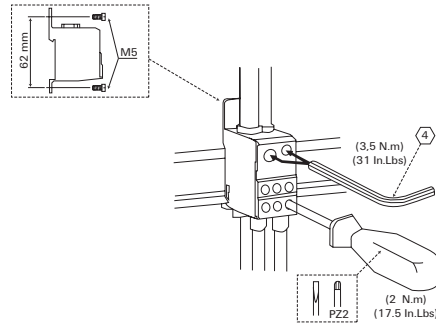

WPDB 35/16/6/N 1/2/5/11

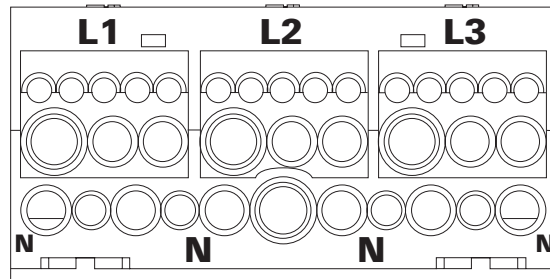

WPDB 3x70/16 1/6

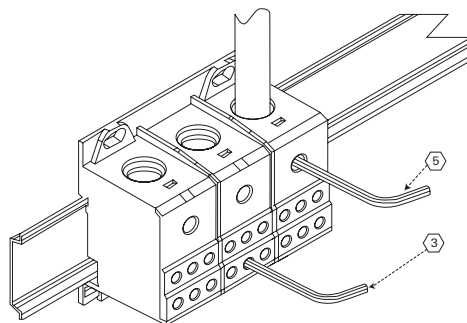

Mini terminals TS 15

In hazardous area applications, the installation instructions and the rated data specifications for accessories given in the technical appendix must be followed.

Width/Length/height with TS15x7.5	mm
max. current / max. cond. cross-section	A/mm ²
Max. clamping range	mm ²

Technical data

Rated data	
Rated voltage	V
Rated current	A
Rated cross-section	mm ²
Rated impulse withstand voltage / Pollution severity Gauge to IEC 60947-1 / Flammability class UL94	
Approvals	
Clamped conductors (H05V/H07V)	
Solid / stranded	mm ²
Flexible / Flexible with ferrule	mm ²
Tightening torque range (terminal screw)	
Stripping length / Blade size	mm/-
2 conductors with same cross-section (H05V/H07V)	
Solid / stranded	mm ²
Flexible / Flexible with ferrule	mm ²
Note	

Ordering data

Version	
	beige (PA)
	Blue (PA)
	green/yellow (PA)
Note	

Accessories

Screwable cross-connection	
	2-pole
	3-pole
	4-pole
	10-pole
External cross-connection	
	2-pole
	3-pole
	4-pole
End plate / Partition plate	
	Dark beige Wemid
	Blue Wemid
	Dark beige Wemid
End bracket	
	Dark beige Wemid
Testing / Checking	
	Test plug
	Socket

Identification systems	
	(see assortment in catalogue 7)
	Marking tags
Note	

AKZ 1.5

1.5 mm²

Feed-through terminal

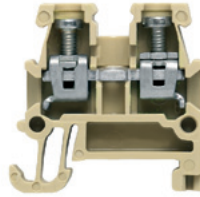

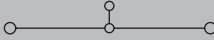
5.1 x 24.8 x 26	
24 / 2.5	
0.21...2.5	

IEC 60947-7-1 II 2 G D

IEC	UL	CSA
250	150 (C)	300 (C)
17.5	15 (C)	10 (C)
1.5	AWG 22...14	AWG 24...16

4 kV / 3
A1 / V-2

	Rated connection
	0.5...2.5 / 1.5...1.5
	0.5...1.5 / 0.5...1.5
	0.4...0.6 (M 2.5)
	7 / 3.0 x 0.5 mm
	0.5...1

Type	Qty.	Order No.
AKZ 1.5	100	0340460000
AKZ 1.5 BL	100	0340480000

AKZ 1.5 Order no. 0340460000 and 0340480000 in PA with flammability rating acc. to UL94/V-2.

Type	current	Qty.	Order No.
Q 2 AKZ1.5	24 A	50	0368200000
Q 3 AKZ1.5	24 A	50	0368300000
Q 4 AKZ1.5	24 A	50	0368400000
Q 10 AKZ1.5	24 A	20	0368500000

	Width		
AP AKZ1.5	1.5 mm	50	0340560000
AP AKZ1.5 BL	1.5 mm	50	0340580000
EW 15	10 mm	50	0382860000
PS 2.3 RT	5.4 mm	20	0180400000
STB 8.5/D4/2.3/M2.5 AKZ		50	0215700000

DEK 5/5
Note

AKZ 2.5

2.5 mm²

Feed-through terminal

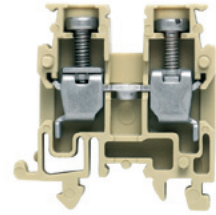

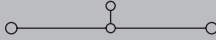
5.1 x 25.5 x 27.1	
32 / 4	
0.13...4	

IEC 60947-7-1 Ex e II  II 2 G D

IEC	UL	CSA	EN 60079-7
250	300 (D)	300 (C)	176
24	10 (D)	10 (C)	15
2.5	AWG 22...12	AWG 26...10	2.5

4 kV / 3
A3 / V-2

	Rated connection	SIRA 02ATEX3001 U
	0.5...4 / 1.5...2.5	
	0.5...2.5 / 0.5...2.5	
	0.4...0.6 (M 2.5)	
	7 / 3.0 x 0.5 mm	
	0.5...1.5	

Type	Qty.	Order No.
AKZ 2.5	100	0697160000
AKZ 2.5 BL	100	0697180000

AKZ 2.5 Order no. 0697160000 and 0697180000 in PA with flammability rating acc. to UL94/V-2.

Type	current	Qty.	Order No.
Q 2 AKZ1.5	24 A	50	0368200000
Q 3 AKZ1.5	24 A	50	0368300000
Q 4 AKZ1.5	24 A	50	0368400000
Q 10 AKZ1.5	24 A	20	0368500000

	Width		
AP AKZ2.5	2.5 mm	50	0697360000
AP AKZ2.5 BL	2.5 mm	50	0697380000
TW AKZ2.5	1.5 mm	20	0318560000
EW 15	10 mm	50	0382860000
PS 2.3 RT	5.4 mm	20	0180400000
STB 8.5/D4/2.3/M2.5 AKZ		50	0215700000

DEK 5/5
Note

AKZ 4

4 mm²

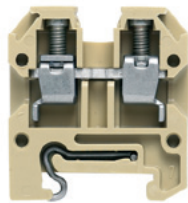

6.1 x 27 x 30.5
41 / 6
0.13...6

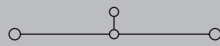

IEC 60947-7-1

Ex e II II 2 G D

IEC	UL	CSA	EN 60079-7
400	300 (C)	300 (C)	275
32	27 (C)	10 (C)	21
4	AWG 22...12	AWG 24...12	4
6 kV / 3			
A3 / V-2			

SIRA 02ATEX3001 U

Rated connection

0.5...6 / 1.5...4
0.5...4 / 0.5...2.5
0.6...0.8 (M 3)
8 / 0.6 x 3.5 mm

0.5...1.5

AKE 2.5

2.5 mm²

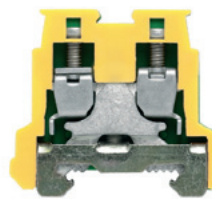

5.1 x 28 x 28
/ 4
0.13...4



IEC 60947-7-2

Ex e II II 2 G D

IEC	UL	CSA	EN 60079-7
2.5	AWG 22...12	AWG 26...12	2.5
/ 3			
A3 / V-2			

SIRA 02ATEX3001 U

Rated connection

0.5...4 / 1.5...2.5
0.5...2.5 / 0.5...2.5
0.4...0.6 (M 2.5)
7 / 3.0 x 0.5 mm

...4

AKE 4

4 mm²



7 x 32 x 34.5
/ 4
0.13...4

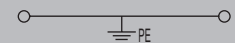

IEC 60947-7-2

Ex e II II 2 G D

IEC	UL	CSA	EN 60079-7
4	AWG 22...12	AWG 26...12	4
/ 3			
A3 / V-2			

SIRA 02ATEX3001 U

Rated connection

0.5...4 / 1.5...4
0.5...4 / 0.5...2.5
0.5...1 (M 3)
9 / 0.6 x 3.5 mm

...4

Type	Qty.	Order No.
AKZ 4	100	0294360000
AKZ 4 BL	100	0294380000

AKZ 4 Order no. 0294360000 and 0294380000 made of PA with flammability class acc. to UL94/V-2.

Type	current	Qty.	Order No.
Q 2 AKZ4	32 A	50	0336400000
Q 3 AKZ4	32 A	50	0336500000
Q 4 AKZ4	32 A	50	0336600000
Q 10 AKZ4	32 A	20	0368600000

Width			
AP AKZ4	1.5 mm	20	0294460000
AP AKZ4 BL	1.5 mm	20	0294480000
TW AKZ4	0.6 mm	50	0348260000
EW 15	10 mm	50	0382860000
PS 2.3 RT	5.4 mm	20	0180400000
STB 8.5/D4/2.3/M2.5 AKZ		50	0215700000

Type	Qty.	Order No.
AKE 2.5	100	1303360000

Type	current	Qty.	Order No.

Type	Qty.	Order No.
AKE 4	100	0380260000

Type	current	Qty.	Order No.

DEK 5/6

DEK 5/5

DEK 5/6.5

Mini terminals TS 15

In hazardous area applications, the installation instructions and the rated data specifications for accessories given in the technical appendix must be followed.

Width/Length/height with TS15x7.5	mm
max. current / max. cond. cross-section	A/mm ²
Max. clamping range	mm ²

Technical data

Rated data	
Rated voltage	V
Rated current	A
Rated cross-section	mm ²
Rated impulse withstand voltage / Pollution severity Gauge to IEC 60947-1 / Flammability class UL94	
Approvals	
Clamped conductors (H05V/H07V)	
Solid / stranded	mm ²
Flexible / Flexible with ferrule	mm ²
Tightening torque range (terminal screw)	
Stripping length / Blade size	mm/-
2 conductors with same cross-section (H05V/H07V)	
Solid / stranded	mm ²
Flexible / Flexible with ferrule	mm ²
Note	

Ordering data

Version	
	Dark beige Wemid (PA)
	Blue Wemid (PA)
Note	

Accessories

Pluggable cross-connection	
	2-pole
	3-pole
	4-pole
	10-pole
End plate / Partition plate	
	Dark beige Wemid
End bracket	
	Dark beige Wemid

Identification systems	
	(see assortment in catalogue 7)
	Marking tags
Note	

WDU 1.5/R 3.5

1.5 mm²

Feed-through terminal (V0)

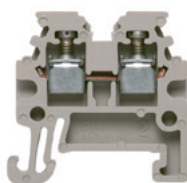

3.5 x 24.5 x 25	
17.5 / 1.5	
0.13...1.5	

IEC 60947-7-1 Ex e II  II 2 G D

IEC	UL	CSA	EN 60079-7
400	300 (D)	300 (D)	275
17.5	10 (D)	10 (D)	14
1.5	AWG 26...14	AWG 26...14	1.5
4 kV / 3			
A1 / V-0			

 KEMA 99ATEX6545 U

Rated connection	
0.5...1.5 / 1.5...1.5	
0.5...1.5 / 0.5...1.5	
0.3 Nm(M 2)	
7 / 0.4 x 2.5 mm	

0.5...0.75
0.5...0.75 / 0.5...0.5

PZ 6/5 recommended as crimping tool for 1.5 mm² with wire end ferrule.

Type	Qty.	Order No.
WDU 1.5/R3.5	100	1753280000
WDU 1.5/R3.5 BL	100	1754170000

Type	current	Qty.	Order No.
ZQV 1.5N/R3.5/2 GE	17.5 A	50	1754210000
ZQV 1.5N/R3.5/3 GE	17.5 A	50	1754220000
ZQV 1.5N/R3.5/4 GE	17.5 A	20	1754230000
ZQV 1.5N/R3.5/10 GE	17.5 A	20	1754290000
Width			
WAP WDK1.5/R3.5	1.5 mm	20	1754200000
EW 15	10 mm	50	0382860000

DEK 5/3,5

WDK 1.5/R3.5

1.5 mm²

Double feed-through terminal (V0)

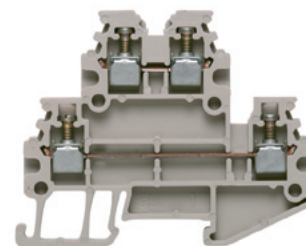

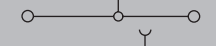
3.5 x 46.5 x 38.5	
16 / 1.5	
0.13...1.5	

IEC 60947-7-1 Ex e II  II 2 G D

IEC	UL	CSA	EN 60079-7
400	300 (D)	300 (D)	275
16	10 (D)	10 (D)	15
1.5	AWG 26...14	AWG 26...14	1.5
4 kV / 3			
A1 / V-0			

 KEMA 99ATEX6545 U

Rated connection	
0.5...1.5 / 1.5...1.5	
0.5...1.5 / 0.5...1.5	
0.3 Nm(M 2)	
7 / 0.4 x 2.5 mm	

0.5...0.75
0.5...0.75 / 0.5...0.5

PZ 6/5 recommended as crimping tool for 1.5 mm² with wire end ferrule.

Type	Qty.	Order No.
WDK 1.5/R3.5	100	1753290000

Type	current	Qty.	Order No.
ZQV 1.5N/R3.5/2 GE	17.5 A	50	1754210000
ZQV 1.5N/R3.5/3 GE	17.5 A	50	1754220000
ZQV 1.5N/R3.5/4 GE	17.5 A	20	1754230000
ZQV 1.5N/R3.5/10 GE	17.5 A	20	1754290000
Width			
WAP WDK1.5/R3.5	1.5 mm	20	1754200000
EW 15	10 mm	50	0382860000

DEK 5/3,5

WPE 1.5/R3.5

1.5 mm²

PE terminal (V0)



In hazardous area applications, the installation instructions and the rated data specifications for accessories given in the technical appendix must be followed.

Width/Length/height with TS15x7.5	mm
max. current / max. cond. cross-section	A/mm ²
Max. clamping range	mm ²

3.5 x 24.5 x 25
/ 1.5
0.13...1.5

Technical data

Rated data	
Rated cross-section	mm ²
Rated voltage to adjoining terminal	V
Rated impulse withstand voltage to adjacent terminal	kV
Rated short-time current	
Pollution severity	
Gauge to IEC 60947-1 / Flammability class UL94	
Approvals	

IEC 60947-7-2

IEC	UL	CSA
1.5	AWG 26...18	AWG 26...18
400		
6		
	180 A (1.5 mm ²)	
	3	
	A1 / V-0	

Clamped conductors (H05V/H07V)	
Solid / stranded	mm ²
Flexible / Flexible with ferrule	mm ²
Tightening torque range (terminal screw)	
Tightening torque range for fixing screw	
Stripping length / Blade size	mm/-

Rated connection	
0.5...1.5 / 1.5...1.5	
0.5...1.5 / 0.5...1.5	
0.3 Nm(M 2)	
7 / 0.4 x 2.5 mm	

Note

PZ 6/5 recommended as crimping tool for 1.5 mm² with wire end ferrule.

Ordering data

Version
green/yellow Wemid (PA)

Note

Type	Qty.	Order No.
WPE 1.5/R3.5	100	1798460000

Accessories

End plate / Partition plate	Dark beige Wemid
End bracket	Dark beige Wemid

Type	Width	Qty.	Order No.
WAP WDU1.5/R3.5	1.5 mm	20	1754190000
EW 15	10 mm	50	0382860000

Identification systems (see assortment in catalogue 7)
Marking tags

DEK 5/3,5

Note

Multi-pole terminal strips for direct mounting

Screw connection

MK 2/12

2.5 mm²

MK 3/2...12

2.5 mm²

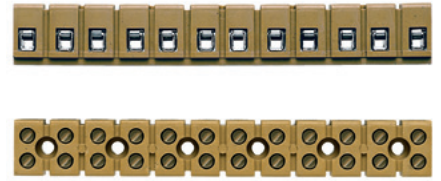
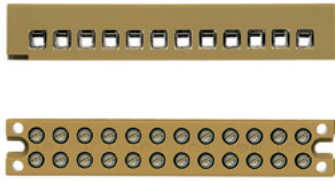

Width/Length/Height of lowest version	mm
max. current / max. cond. cross-section	A/mm ²
Max. clamping range	mm ²

15 x 86 x 15
24 / 4
0.2...4

15 x 91.25 x 16.1
24 / 4
0.33...4

Technical data

Rated data	
Rated voltage	V
Rated current	A
Rated cross-section	mm ²
Rated impulse withstand voltage / Pollution severity	
Gauge to IEC 60947-1 / Flammability class UL94	
Approvals	
Clamped conductors (H05V/H07V)	
Solid / stranded	mm ²
Flexible / Flexible with ferrule	mm ²
Tightening torque range (terminal screw)	
Stripping length / Blade size	

IEC 60947-7-1

IEC	UL	CSA
125	300 (D)	300 (D)
24	10 (D)	10 (D)
2.5	AWG 24...12	AWG 24...12
2.5 kV / 3		
A2 / 5VA		
Rated connection		
0.5...4 / 1.5...2.5		
0.5...2.5 / 0.5...1.5		
0.4 (M 2.5)		
5 / 0.6 x 3.5 mm		

IEC 60947-7-1

IEC	UL	CSA
400	600 (D)	300 (C)
24	5 (D)	25 (C)
2.5	AWG 22...12	AWG 22...12
6 kV / 3		
A2 / 5VA		
Rated connection		
0.5...4 / 1.5...2.5		
0.5...2.5 / 0.5...1.5		
0.4...0.45 Nm (M 2.5)		
5 / 0.6 x 3.5 mm		

Ordering data

Type	Length	Mounting	Qty.	Order No.	
2-pole					
3-pole					
4-pole					
5-pole					
6-pole					
7-pole					
8-pole					
10-pole					
12-pole	MK 2/12	86 mm	80 mm	50	0241260000
16-pole					

Type	Length	Mounting	Qty.	Order No.
MK 3/2	17.4 mm	18.5 mm	100	0273820000
MK 3/3	26.5 mm	18.5 mm	50	0273920000
MK 3/4	35.75 mm	18.5 mm	50	0274020000
MK 3/5	45 mm	18.5 mm	50	0274120000
MK 3/6	54.25 mm	37 mm	50	0274220000
MK 3/7	63.5 mm	37 mm	50	0274320000
MK 3/8	72.75 mm	55.5 mm	25	0274420000
MK 3/10	91.25 mm	74 mm	20	0274620000
MK 3/12	110 mm	92.5 mm	20	0243520000

Accessories

Type	Qty.	Order No.
BSTB 28/12/6.35 U 1-12	50	0245700000
BSTB 28/12/6.35 O 1-12	50	0278500000
Marking strips, unprinted		

Type	Qty.	Order No.
BSTB 28/12 MK U 1-12	50	0245900000
BSTB 28/8 MK U 1-8	50	0290200000
BSTB 28/6 MK U 1-6	50	0290000000
BSTO 28/12 MK	50	0245800000
BSTO 28/8 MK3/8	50	0284700000
BSTO 28/6 MK	50	0289500000
BSTO 28/4 MK3/4	50	0289300000

(see assortment in catalogue 7)

For detailed information on other accessories and applications, refer to the "Accessories" section

MK 4/16

2.5 mm²

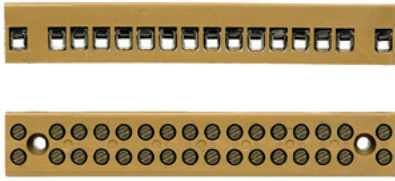

17 x 103 x 16
24 / 4
0.2...4

IEC 60947-7-1

IEC	UL	CSA
400	150 (C)	150 (C)
24	15 (C)	15 (C)
2.5	AWG 22...12	AWG 22...12
6 kV / 3		
A2 / 5VA		



Rated connection

0.5...4 / 1.5...2.5
0.5...2.5 / 0.5...1.5
0.4...0.45 Nm (M 2.5)
5 / 0.6 x 3.5 mm

MK 6/2...6/6

6 mm²

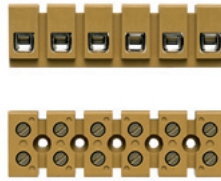

23 x 23.5 x 22
41 / 6
0.33...6

IEC 60947-7-1

IEC	UL	CSA
690	300 (C)	300 (C)
41	20 (C)	40 (C)
6	AWG 22...10	AWG 22...10
8 kV / 3		
A3 / 5VA		



Rated connection

0.5...6 / 1.5...6
0.5...6 / 0.5...4
1.2...2 Nm (M 4)
9 / 4.0 x 0.8 mm

Type	Length	Mounting	Qty.	Order No.
MK 4/16	103 mm	85.5 mm	20	0244220000

Type	Length	Mounting	Qty.	Order No.
MK 6/2	23.5 mm		50	0620420000
MK 6/3	36.5 mm	13 mm	50	0620320000
MK 6/4	49.5 mm	26 mm	20	0620220000
MK 6/6	75.5 mm	52 mm	20	0620120000

Type	Qty.	Order No.
BSTB 28/16 MK U 1-16	50	0262200000
BSTO 28/16 MK 4/16	50	0262100000

Type	Qty.	Order No.

Multi-pole terminal strips for direct mounting

Screw connection

MK 5/2 0.DE

2.5 mm²

KS 2...10

2.5 mm²

Width/Length/Height of lowest version	mm
max. current / max. cond. cross-section	A/mm ²
Max. clamping range	mm ²

18 x 40 x 14
24 / 4
0.2...4

25 x 138 x 20
24 / 4
0.2...4

Technical data

Rated data	
Rated voltage	V
Rated current	A
Rated cross-section	mm ²
Rated impulse withstand voltage / Pollution severity Gauge to IEC 60947-1 / Flammability class UL94	
Approvals	
Clamped conductors (H05V/H07V)	
Solid / stranded	mm ²
Flexible / Flexible with ferrule	mm ²
Tightening torque range (terminal screw)	
Stripping length / Blade size	

IEC	UL	CSA
500		300 (C)
24		25 (C)
2.5		AWG 20...14
6 kV / 3		
A2 / 5VA		
®		
Rated connection		
0.5...4 / 1.5...2.5		
0.5...2.5 / 0.5...1.5		
0.4(M 2.5)		
5 / 0.6 x 3.5 mm		

IEC 60947-7-1

IEC	UL	CSA
500	300 (C)	300 (C)
24	20 (C)	25 (C)
2.5	AWG 22...12	AWG 24...12
6 kV / 3		
A2 / 5VA		
®		
Rated connection		
0.5...4 / 1.5...2.5		
0.5...2.5 / 0.5...1.5		
0.5...0.7 Nm (M 3)		
8 / 4.0 x 0.8 mm		

Ordering data

Type	Length	Mounting	Qty.	Order No.
2-pole				
3-pole				
4-pole				
6-pole				
10-pole				
12-pole				

Type	Length	Mounting	Qty.	Order No.
MK 5/2 0.DE	40 mm	32 mm	100	0243820000

Type	Length	Mounting	Qty.	Order No.
KS 2 0.D2	42 mm	32 mm	100	0134420000
KS 4 0.D4	66 mm	56 mm	50	0140320000
KS 6 0.D6	90 mm	80 mm	50	0140620000
KS 10 0.D10	138 mm	128 mm	20	0141620000

Accessories

Type	Qty.	Order No.
Lid / cover		
Marking strips, printed		
Marking strips, unprinted		

Type	Qty.	Order No.
D 2 MK5/2 PA/NA	50	0244060000

Type	Qty.	Order No.
D2 KS2 TP	100	0134500000
D4 KS4 TP	50	0140500000
D6 KS6 TP	50	0140800000
D10 KS10 TP	20	0141800000
ELSB 2 BEZ. 1-2	50	0143200000
ELSB 10 BEZ. 1-10	50	0143500000

(see assortment in catalogue 7)

For detailed information on other accessories and applications, refer to the "Accessories" section.

BK 2...12

4 mm²



22 x 92 x 20
32 / 4
0.33...4

IEC 60947-7-1

IEC	UL	CSA
400	150 (C)	300 (D)
32	20 (C)	10 (D)
4	AWG 22...12	AWG 22...12
6 kV / 3		
A3 / 5VA		

Rated connection

0.5...4 / 1.5...4
0.5...4 / 0.5...4
0.5...0.6 Nm (M 3)
8 / 4.0 x 0.8 mm

Two solid (single-core) conductors of equal cross-section (0.5 ... 1.5 mm²) can be connected.

Type	Length	Mounting	Qty.	Order No.
BK 2 CRN	20 mm		100	0624720000
BK 3 CRN	31 mm	11 mm	100	0624920000
BK 4 CRN	38 mm	18 mm	100	0625120000
BK 6 CRN	52 mm	32 mm	50	0625220000
BK 12 CRN	92 mm	72.5 mm	25	0625320000

Type	Qty.	Order No.
BSTB 28/2 BK U 1-2	50	0203600000
BSTB 28/4 BK U 1-4	50	0197300000
BSTB 28/6 BK U 1-6	50	0197500000
BSTB 28/12 BK U 1-12	50	0198800000
BSTO 28/2 BK	50	0203500000
BSTO 28/3 BK	50	0203700000
BSTO 28/4 BK	50	0197200000
BSTO 28/6 BK	50	0197400000
BSTO 28/12 BK	50	0198700000



Terminals for direct mounting

D

Multi-pole terminal strips for direct mounting

**Screw connection
ATEX approval**

BK 2...12/E

4 mm²

MK 3/2...12/E

2.5 mm²

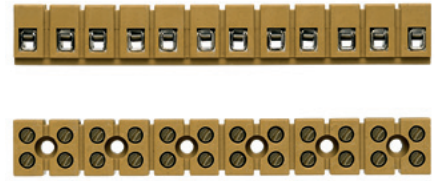

Width/Length/Height of lowest version	mm
max. current / max. cond. cross-section	A/mm ²
Max. clamping range	mm ²

22 x 92 x 20
32 / 4
0.33...4

15 x 110 x 16.1
24 / 4
0.33...4

Technical data

Rated data	
Rated voltage	V
Rated current	A
Rated cross-section	mm ²
Rated impulse withstand voltage / Pollution severity	
Gauge to IEC 60947-1 / Flammability class UL94	
Approvals	
Clamped conductors (H05V/H07V)	
Solid / stranded	mm ²
Flexible / Flexible with ferrule	mm ²
Tightening torque range (terminal screw)	
Stripping length / Blade size	

IEC 60947-7-1	Ex e II II 2 G D		
IEC	UL	CSA	EN 60079-7
400	150 (C)	300 (D)	275
32	20 (C)	10 (D)	21
4	AWG 22...12	AWG 22...12	4
6 kV / 3			
A3 / 5VA			
		BAS 98ATEX3084 U	
Rated connection			
0.5...4 / 1.5...4			
0.5...4 / 0.5...4			
0.5...0.6 Nm (M 3)			
8 / 4.0 x 0.8 mm			

IEC 60947-7-1	Ex e II II 2 G D		
IEC	UL	CSA	EN 60079-7
400	600 (D)	300 (C)	275
24	5 (D)	25 (C)	15
2.5	AWG 22...12	AWG 22...12	2.5
6 kV / 3			
A2 / 5VA			
		BAS 99ATEX2124 U	
Rated connection			
0.5...4 / 1.5...2.5			
0.5...2.5 / 0.5...1.5			
0.4...0.45 Nm (M 2.5)			
5 / 0.6 x 3.5 mm			

Two solid (single-core) conductors of equal cross-section (0.5 ... 1.5 mm²) can be connected.

Ordering data

Type	Length	Mounting	Qty.	Order No.	
2-pole	BK 2/E	20 mm	100	7906040000	
3-pole	BK 3/E	31 mm	11 mm	100	7906060000
4-pole	BK 4/E	38 mm	18 mm	100	7906080000
5-pole					
6-pole	BK 6/E	52 mm	32 mm	50	7906090000
8-pole					
12-pole	BK 12/E	92 mm	72.5 mm	25	7906100000

Type	Length	Mounting	Qty.	Order No.
MK 3/2/E	17.4 mm	18.5 mm	100	7906110000
MK 3/3/E	26.5 mm	18.5 mm	50	7906120000
MK 3/4/E	35.75 mm	18.5 mm	50	7906130000
MK 3/6/E	54.25 mm	37 mm	50	7906150000
MK 3/8/E	72.75 mm	55.5 mm	25	7906170000
MK 3/12/E	110 mm	92.5 mm	20	7906210000

Accessories

Marking strips, printed	
BSTB 28/2 BK U 1-2	50 0203600000
BSTB 28/4 BK U 1-4	50 0197300000
BSTB 28/6 BK U 1-6	50 0197500000
BSTB 28/12 BK U 1-12	50 0198800000
Marking strips, unprinted	
BSTO 28/2 BK	50 0203500000
BSTO 28/3 BK	50 0203700000
BSTO 28/4 BK	50 0197200000
BSTO 28/6 BK	50 0197400000
BSTO 28/12 BK	50 0198700000

Type	Qty.	Order No.
BSTB 28/12 MK U 1-12	50	0245900000
BSTB 28/8 MK U 1-8	50	0290200000
BSTB 28/6 MK U 1-6	50	0290000000
Marking strips, unprinted		
BSTO 28/12 MK	50	0245800000
BSTO 28/8 MK3/8	50	0284700000
BSTO 28/6 MK	50	0289500000
BSTO 28/4 MK3/4	50	0289300000

(see assortment in catalogue 7)

For detailed information on other accessories and applications, refer to the "Accessories" section.

MK 6/2...6/E

6 mm²

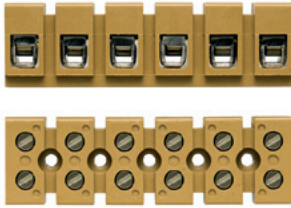

23 x 75.5 x 22

41 / 6

0.33...6

IEC 60947-7-1

Ex e II



II 2 G D

IEC	UL	CSA	EN 60079-7
690	300 (C)		440
41	20 (C)		26
6	AWG 22...10		6
8 kV / 3			
A3 / 5VA			

UL BAS 99ATEX2123 U

Rated connection

0.5...6 / 1.5...6

0.5...6 / 0.5...4

1.2...2 Nm (M 4)

9 / 4.0 x 0.8 mm

Type	Length	Mounting	Qty.	Order No.
MK 6/2/E	23.5 mm		50	7906220000
MK 6/3/E	36.5 mm	13 mm	50	7906230000
MK 6/4/E	49.5 mm	26 mm	20	7906240000
MK 6/5/E	62.5 mm	26 mm	20	7906250000
MK 6/6/E	75.5 mm	52 mm	20	7906260000

Type	Qty.	Order No.

Weidmüller stud terminals

Safe connections for reliable energy transfer

In harsh environments, robust products are important; but they should also be an affordable solution. Our stud terminals meet these requirements exactly: safe power transmission in connection ranges from 10 mm² to 300 mm².

The conductors are attached to the terminals using crimped cable lugs and each connection is secured by tightening the hexagonal nut. A low voltage drop and the use of a self-extinguishing material with a V0 (UL94) flammability rating guarantee maximum safety.

Fit for Transportation

All stud terminals are tested according to the international railway standards and meet the requirements specified.

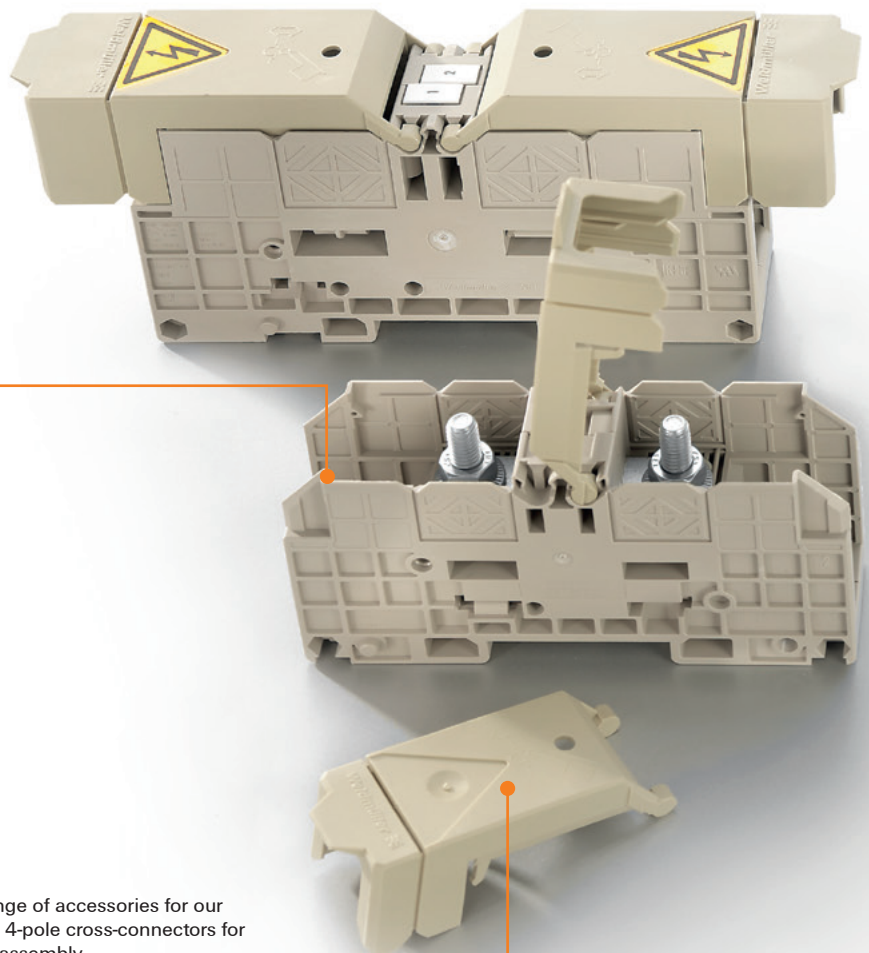
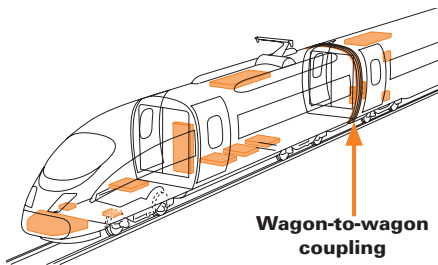

Flexible accessories

We offer a comprehensive range of accessories for our stud terminals, e.g. 2-, 3-, and 4-pole cross-connectors for potential distribution. Simple assembly.



Variable system

Stud terminals in bolt sizes M5 to M16
 For conductors with cable lugs according to DIN 46234 up to 240 mm² and DIN 46235 up to 300 mm². Up to four cable lugs per bolt possible.
 For voltages ranges up to 4,000 V and currents up to 415 A.

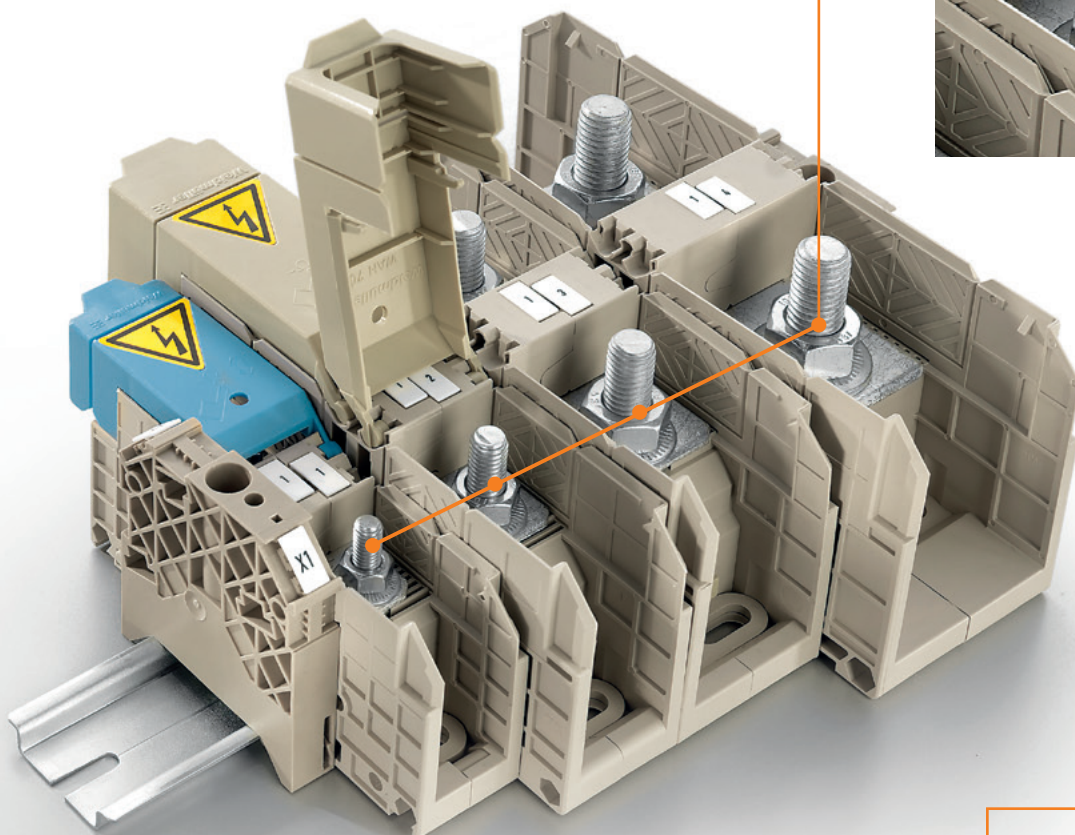

Safe operation

Touch-safe protection is guaranteed thanks to cover profiles or the snap-on and screwable cover hoods.

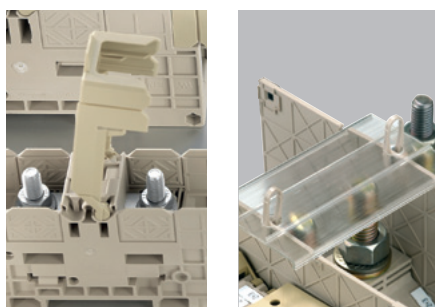

Usage and handling

Cable lugs are crimped onto the wire ends to connect the wires.
 The cable lugs are put on between the washer on the clamp support and the thrust washer on the stud.
 The back sides of the cable lugs are positioned against each other. As the hex nut is tightened, the cable lugs press against each other to form a secure contact.

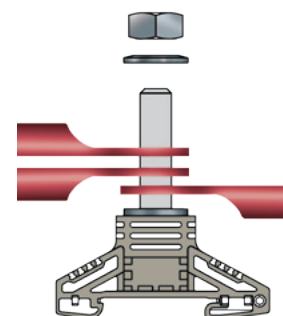

Stud terminals - Accessories

Series WF and WFF

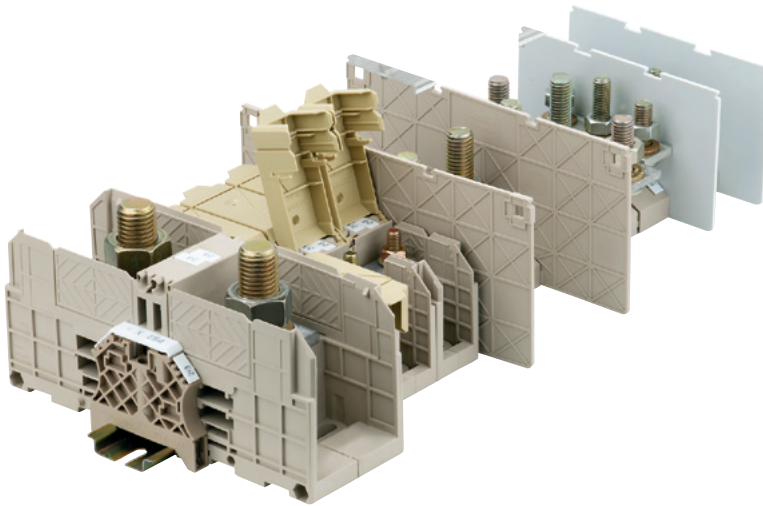

Electrical distribution



Electrical distribution can be realised between neighbouring stud terminals easily with 2 and 3 poles cross-connections. Cross-connections are also available for different thread sizes from M6 to M8 or M10. In the WFF two-stud terminals, firstly the partition plates have to be removed between the clamped supports. The thin web of material means they can be broken out easily to fit.

Shock protection



The two-stud terminals in the WF-Series offer, with an integrated hinge cover, a high degree of finger safety. When closed, the cover locks onto the terminal and protects the contact from accidental contact.

Shock protection / partition plates

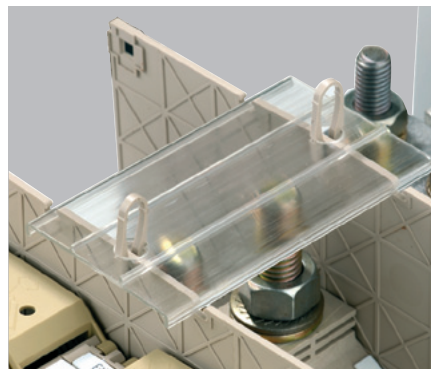

Shock protection in the WF-Series is provided by partition plates WTW and transparent cover strips ADP. The cover strips are locked into the guides of the partition plates and held with clips to prevent them slipping to the side. Partition plates ensure compliance with the rated voltages:

- Voltage range up to 1000 V with partition plate WTW WF
- Voltage range up to 2300 V for WF with epoxy partition plate WTW WF 2300

Connection



Couldn't be easier: the cable lugs are placed on the stud with the washer and toothed washer on top. A normal open-ended spanner can be used to tighten the hex screw and complete installation.

Series ST 4000

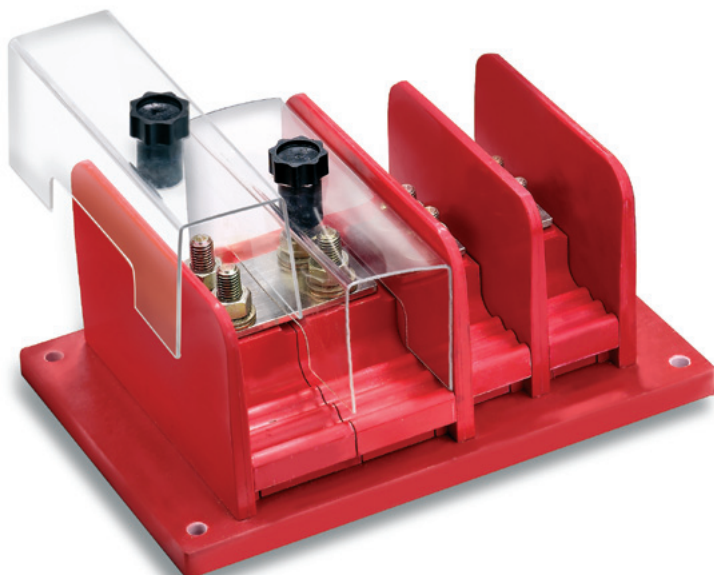

Shock protection



Stud terminals in the ST 4000 series offer an ideal cover for every version. The polycarbonate cover is placed between the partition plates and fastened to the stud with the plastic-coated fixing nut.

Fixing nuts are available to fit every stud size.

Potential distribution



When two neighbouring ST 4000 terminals have the same current, cross-connectors are fitted instead of the busbar.

The pairs of holes in the cross-connection are rated exactly to the spacing of ST 4000.

Here the partition plate has to be replaced by the connecting piece ST 4000/S C130 or ST 4000/L C160.

Cross-connections are available as 2-, 3-, or 4-poles.

Connection



Couldn't be easier: the cable lugs are placed on the stud with the washer and toothed washer on top. Tighten the steel hexagonal nut to ensure good contact between cable lug and busbar.

The same principle applies when two cable lugs contact on one stud or slotted hole cable lugs are used.

Slotted hole cable lugs can also be placed over both studs.

Single-stud terminals

WF-series

WF 5

16 mm²

Screw thread M5

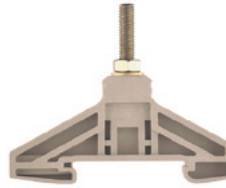

13 x 67 x 56
76 / 16
0.1...16

WF 6

35 mm²

Screw thread M6

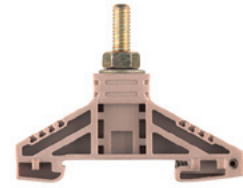

17.8 x 67 x 56
125 / 35
2.5...35

In hazardous area applications, the installation instructions and the rated data specifications for accessories given in the technical appendix must be followed.

Width/Length/Height of lowest version	mm
max. current / max. cond. cross-section	A
Max. clamping range	mm ²

Technical data

Rated data with Wemid partition wall

Rated voltage	V
Rated current	A
Rated cross-section	mm ²
Rated impulse withstand voltage / Pollution severity	
Gauge to IEC 60947-1 / Flammability class UL94	

Approvals

Clamped cable lugs

Cable lug to DIN 46234
2 x cable lugs DIN 46 234
Cable lug to DIN 46235
2 x cable lugs DIN 46 235
Tightening torque range

Note

IEC	UL	CSA
1000	1000 (C)	1000 (C)
76	85 (C)	85 (C)
16	AWG 10...4	AWG 10...4
8 kV / 3 / V-0		



0.1...16 mm ²
0.1...16 mm ²
6...10 mm ²
6...10 mm ²
2...4 Nm

IEC	UL	CSA
1000	1000 (C)	1000 (C)
125	115 (C)	150 (C)
35	AWG 14...2	AWG 14...2
8 kV / 3 / V-0		



2.5...35 mm ²
2.5...35 mm ²
6...25 mm ²
6...25 mm ²
3...6 Nm

Ordering data

Version	Dark beige Wemid
Note	

Type	Qty.	Order No.
WF 5	25	1790130000
1000 V UL and CSA for usage groups B and C: can be used with isolating DIN rails and when using WTW-type partitions.		

Type	Qty.	Order No.
WF 6	25	1780850000
1000 V UL and CSA for usage groups B and C: can be used with isolating DIN rails and when using WTW-type partitions.		

Accessories

Cross-connection	2-pole
	3-pole
	4-pole

Partition plate	Dark beige Wemid
	Beige epoxy resin

End bracket	Dark beige Wemid
-------------	------------------

Hood transparent	Hood transparent
------------------	------------------

Holder for shrouding cover transparent	Holder for shrouding cover transparent
--	--

Type	current	Qty.	Order No.
WQL 2 WF5	101 A	5	1812710000
WQL 3 WF5		5	1812740000

Width			
WTW WF6-WF12	2.5 mm	20	1781240000
WTW WF6 2300	3 mm	20	1781230000

WEW 35/2	8 mm	100	1061200000
----------	------	-----	-------------------

ADP WF6/WF8		1	1780930000
-------------	--	---	-------------------

HA ADP WF6/WF10	2.2 mm	10	1781050000
-----------------	--------	----	-------------------

Type	current	Qty.	Order No.
WQL 2 WF6	125 A	5	1780970000
WQL 3 WF6	125 A	5	1780980000

Width			
WTW WF6	3 mm	20	1781220000
WTW WF6 2300	3 mm	20	1781230000

WEW 35/2	8 mm	100	1061200000
----------	------	-----	-------------------

ADP WF6/WF8		1	1780930000
-------------	--	---	-------------------

HA ADP WF6/WF10	2.2 mm	10	1781050000
-----------------	--------	----	-------------------

Identification systems	(see assortment in catalogue 7)
Note	Marking tags

WS 12/5	With WTW...2300 made from epoxy resin, rated current 2300 V according to prelim. EN 50124 pt 1.
---------	---

WS 10/6	With WTW...2300 made from epoxy resin, rated current 2300 V according to prelim. EN 50124 pt 1.
---------	---

WF 8

50 mm²

Screw thread M8

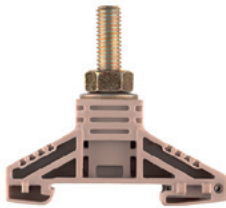

22.8 x 67 x 65
150 / 50
2.5...50

IEC	UL	CSA
1000	1000 (C)	1000 (C)
150	150 (C)	200 (C)
50	AWG 14...0	AWG 14...0

8 kV / 3
 / V-0



- 2.5...50 mm²
- 2.5...50 mm²
- 6...35 mm²
- 6...35 mm²
- 6...12 Nm

The WQL 2 for WF 6 on the WF 8 is available under Order no. 1808980000.

Type	Qty.	Order No.
WF 8	25	1780860000

1000 V UL and CSA for usage groups B and C; can be used with isolating DIN rails and when using WTW-type partitions.

Type	current	Qty.	Order No.
WQL 2 WF8	150 A	5	1780990000
WQL 3 WF8	150 A	5	1781000000
Width			
WTW WF8	3 mm	20	1780900000
WTW WF8 2300	3 mm	20	1780910000
WEW 35/2	8 mm	100	1061200000
ADP WF6/WF8		1	1780930000
HA ADP WF6/WF10	2.2 mm	10	1781050000

WS 10/6

With WTW...2300 made from epoxy resin, rated current 2300 V according to prelim. EN 50124 pt 1.

WF 10

120 mm²

Screw thread M10

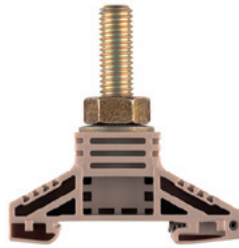

33.8 x 67 x 74
269 / 120
6...120

IEC	UL	CSA
1000	1000 (C)	1000 (C)
269	255 (C)	320 (C)
120	AWG 10...250	AWG 10...250

8 kV / 3
 / V-0



- 6...120 mm²
- 6...120 mm²
- 10...95 mm²
- 10...95 mm²
- 10...20 Nm

The WQL 2 for WF 6 on the WF 10 is available under Order no. 1806620000.

Type	Qty.	Order No.
WF 10	20	1780870000

1000 V UL and CSA for usage groups B and C; can be used with isolating DIN rails and when using WTW-type partitions.

Type	current	Qty.	Order No.
WQL 2 WF10	265 A	5	1781010000
WQL 3 WF10	265 A	5	1781020000
WQL 4 WF10		5	1027840000
Width			
WTW WF10/WF12	3 mm	20	1780890000
WTW WF10/WF12 2300	3 mm	20	1780920000
WEW 35/2	8 mm	100	1061200000
ADP WF10/WF12		1	1780940000
HA ADP WF6/WF10	2.2 mm	10	1781050000

WS 10/6

With WTW...2300 made from epoxy resin, rated current 2300 V according to prelim. EN 50124 pt 1.

WF 12

120 mm²

Screw thread M12

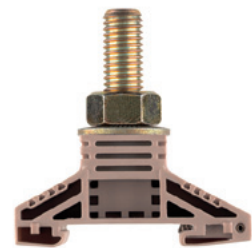

33.8 x 67 x 72
269 / 120
6...120

IEC	UL	CSA
1000	1000 (C)	1000 (C)
269	255 (C)	320 (C)
120	AWG 10...250	AWG 10...250

8 kV / 3
 / V-0



- 6...120 mm²
- 6...120 mm²
- 10...95 mm²
- 10...95 mm²
- 14...31 Nm

Type	Qty.	Order No.
WF 12	20	1780880000

1000 V UL and CSA for usage groups B and C; can be used with isolating DIN rails and when using WTW-type partitions.

Type	current	Qty.	Order No.
WQL 2 WF12	265 A	5	1781030000
WQL 3 WF12	265 A	5	1781040000
Width			
WTW WF10/WF12	3 mm	20	1780890000
WTW WF10/WF12 2300	3 mm	20	1780920000
WEW 35/2	8 mm	100	1061200000
ADP WF10/WF12		1	1780940000
HA ADP WF6/WF10	2.2 mm	10	1781050000

WS 10/6

With WTW...2300 made from epoxy resin, rated current 2300 V according to prelim. EN 50124 pt 1.

Twin stud terminals

WF 2BZ

WF 6/2BZ

35 mm²

WF 8/2BZ

50 mm²

Screw thread M6

Screw thread M8

In hazardous area applications, the installation instructions and the rated data specifications for accessories given in the technical appendix must be followed.

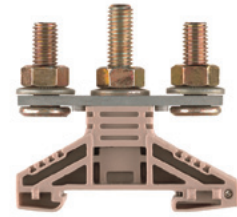
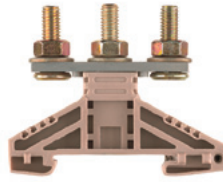

Width/Length/Height of lowest version	mm
max. current / max. cond. cross-section	A/mm ²
Max. clamping range	mm ²

17.8 x 67 x 56	
125 / 35	
2.5...35	

22.8 x 67 x 65	
150 / 50	
2.5...50	

Technical data

Rated data with Wemid partition wall	
Rated voltage	V
Rated current	A
Rated cross-section	mm ²
Rated impulse withstand voltage / Pollution severity	
Gauge to IEC 60947-1 / Flammability class UL94	
Approvals	

IEC	UL	CSA
1000	1000 (C)	
125	115 (C)	
35	AWG 14...2	
8 kV / 3		
/ V-0		

IEC	UL	CSA
1000	1000 (C)	
150	150 (C)	
50	AWG 14...0	
8 kV / 3		
/ V-0		

Clamped cable lugs	
Cable lug to DIN 46234	
2 x cable lugs DIN 46 234	
Cable lug to DIN 46235	
2 x cable lugs DIN 46 235	
Tightening torque range	

2.5...35 mm ²
2.5...35 mm ²
6...25 mm ²
6...25 mm ²
3...6 Nm

2.5...50 mm ²
2.5...50 mm ²
6...35 mm ²
6...35 mm ²
6...12 Nm

Note

Ordering data

Version	
	Dark beige Wemid
Note	

Type	Qty.	Order No.
WF 6/2BZ	25	1789770000
1000 V UL and CSA for usage groups B and C: can be used with isolating DIN rails and when using WTW-type partitions.		

Type	Qty.	Order No.
WF 8/2BZ	25	1789780000
1000 V UL and CSA for usage groups B and C: can be used with isolating DIN rails and when using WTW-type partitions.		

Accessories

Cross-connection	
	2-pole
	3-pole
Partition plate	
	Dark beige Wemid
	Beige epoxy resin
End bracket	
	Dark beige Wemid
Hood transparent	
	Hood transparent
Holder for shrouding cover transparent	
	Holder for shrouding cover transparent

Type	current	Qty.	Order No.
WQL 2 WF6	125 A	5	1780970000
WQL 3 WF6	125 A	5	1780980000
Width			
WTW WF10/WF12	3 mm	20	1780890000
WTW WF6 2300	3 mm	20	1781230000
WEW 35/2	8 mm	100	1061200000
ADP WF10/WF12		1	1780940000
HA ADP WF6/WF10	2.2 mm	10	1781050000

Type	current	Qty.	Order No.
WQL 2 WF8	150 A	5	1780990000
WQL 3 WF8	150 A	5	1781000000
Width			
WTW WF10/WF12	3 mm	20	1780890000
WTW WF8 2300	3 mm	20	1780910000
WEW 35/2	8 mm	100	1061200000
ADP WF10/WF12		1	1780940000
HA ADP WF6/WF10	2.2 mm	10	1781050000

Identification systems	(see assortment in catalogue 7)
	Marking tags
Note	

WS 12/5
With WTW...2300 made from epoxy resin, rated current 2300 V according to prelim. EN 50124 pt 1.

WS 12/5
With WTW...2300 made from epoxy resin, rated current 2300 V according to prelim. EN 50124 pt 1.

WF 10/2BZ

120 mm²

Screw thread M10

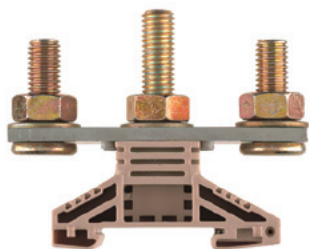

33.8 x 87.6 x 74

269 / 120

6...120



IEC	UL	CSA
1000	1000 (C)	
269	255 (C)	
120	AWG 10...250	
	8 kV / 3	
	/ V-0	

9L

6...120 mm²6...120 mm²10...95 mm²10...95 mm²

10...20 Nm

Type	Qty.	Order No.
WF 10/2BZ	20	1789790000

1000 V UL and CSA for usage groups B and C; can be used with isolating DIN rails and when using WTW-type partitions.

Type	current	Qty.	Order No.
WQL 2 WF10	265 A	5	1781010000
WQL 3 WF10	265 A	5	1781020000
	Width		
WTW WF10/WF12	3 mm	20	1780890000
WTW WF10/WF12 2300	3 mm	20	1780920000
WEW 35/2	8 mm	100	1061200000
ADP WF10/WF12		1	1780940000
HA ADP WF6/WF10	2.2 mm	10	1781050000

With WTW...2300 made from epoxy resin, rated current 1500 V up to 70 mm² according to prelim. EN 50124 pt 1.

Twin stud terminals

WFF series

In hazardous area applications, the installation instructions and the rated data specifications for accessories given in the technical appendix must be followed.

Width/Length/Height of lowest version	mm
max. current / max. cond. cross-section	A/mm ²
Max. clamping range	mm ²

Technical data

Rated data with Wemid partition wall	
Rated voltage	V
Rated current	A
Rated cross-section	mm ²
Rated impulse withstand voltage / Pollution severity	
Gauge to IEC 60947-1 / Flammability class UL94	
Approvals	
Clamped cable lugs	
Cable lug to DIN 46234 / 2 x cable lugs DIN 46 234	
Cable lug to DIN 46235 / 2 x cable lugs DIN 46 235	
Tightening torque, min.	

Note

Ordering data

Version	
Dark beige Wemid	
Dark beige Wemid	
Blue Wemid	

Note

Accessories

Cross-connection	
	2-pole
	3-pole
Partition plate	
	Dark beige Wemid
End bracket	
	Dark beige Wemid
Hood	
	Hood, dark beige Wemid
Warning triangle for power supply terminals	

Identification systems	(see assortment in catalogue 7)
	Marking tags
Note	

WFF 35

35 mm²

Screw thread M6

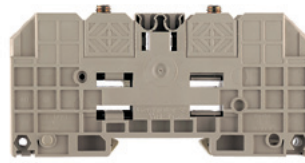

27 x 107 x 59.5
150 / 50
2.5...50

Ex e II II 2 G D

IEC	UL	CSA	EN 60079-7
1000	1000 (C)	600 (C)	1100
125	115 (C)	130 (C)	109
35	AWG 14...2	AWG 14...2	35
8 kV / 3			
/ V-0			
KEMA 98ATEX1684 U			
2.5...50 mm ² /			
6...25 mm ² /			
3			

Type	Qty.	Order No.
WFF 35	10	1028300000
WFF 35/AH	5	1029300000
WFF 35 BL	10	1028380000

1000 V UL and CSA for usage groups B and C: can be used with isolating DIN rails and when using WTW-type partitions.

Type	current	Qty.	Order No.
WQL 2 WFF35	150 A	5	1064900000
WQL 3 WFF35	150 A	5	1065400000
Width			
WTW WFF35	2 mm	10	1067100000
Width			
WEW 35/1	12 mm	50	1059000000
WAH 35	26 mm	20	1064460000
WD 1 25 K KARTE A 6 ST		5	1563900000

WS 12/6,5
WAH 35 in blue, Order no. 1064480000

WFF 70

70 mm²

Screw thread M8

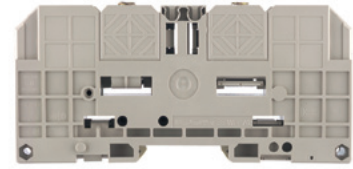

32 x 132 x 69.5
232 / 95
2.5...95

Ex e II II 2 G D

IEC	UL	CSA	EN 60079-7
1000	1000 (C)	600 (C)	1100
192	175 (C)	170 (C)	167
70	AWG 14...00	AWG 14...00	70
8 kV / 3			
/ V-0			
KEMA 98ATEX1684 U			
2.5...95 mm ² /			
16...70 mm ² /			
6			

When connecting cable lugs (in accordance with DIN 46234) with 70 and 95 mm², the rated voltage is reduced to 800 V.

Type	Qty.	Order No.
WFF 70	10	1028400000
WFF 70/AH	5	1029400000
WFF 70 BL	10	1028480000

1000 V UL and CSA for usage groups B and C: can be used with isolating DIN rails and when using WTW-type partitions.

Type	current	Qty.	Order No.
WQL 2 WFF70	232 A	5	1065000000
WQL 3 WFF70	232 A	5	1065500000
Width			
WTW WFF70	2 mm	10	1067200000
Width			
WEW 35/1	12 mm	50	1059000000
WAH 70 BE	31 mm	20	1064560000
WD 1 25 K KARTE A 6 ST		5	1563900000

WS 12/6,5
WAH 70 in blue, Order no. 1064580000

WFF 120

120 mm²

Screw thread M10

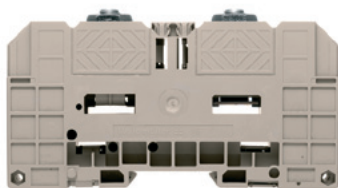

38 x 229.5 x 88.5
41 / 150
6...150



IEC 60947-7-1

Ex e II II 2 G D

IEC	UL	CSA	EN 60079-7
400	1000 (C)	600 (C)	275
32	310 (C)	310 (C)	21
4	AWG 10...250	AWG 10...250	4

6 kV / 3
 / V-0

KEMA 98ATEX1684 U

6...150 mm² /
 16...150 mm² /
 10

Type	Qty.	Order No.
WFF 120	5	1028500000
WFF 120/AH	4	1029500000
WFF 120 BL	5	1028580000

1000 V UL and CSA for usage groups B and C; can be used with isolating DIN rails and when using WTW-type partitions.

Type	current	Qty.	Order No.
WQL 2 WFF120	309 A	5	1065100000
WQL 3 WFF120	309 A	5	1065600000
Width			
WTW WFF120	2 mm	10	1067300000
WEW 35/1	12 mm	50	1059000000
WAH 120	41 mm	20	1064660000
WD 1 25 K KARTE A 6 ST		5	1563900000

WS 12/6,5

WAH 120 in blue, Order no. 1064650000

WFF 185

185 mm²

Screw thread M12



55 x 163 x 87
415 / 240
10...240



Ex e II II 2 G D

IEC	UL	CSA	EN 60079-7
1000	1000 (C)	600 (C)	1100
353	380 (C)	360 (C)	307
185	AWG 8...500	AWG 8...500	185

8 kV / 3
 / V-0

KEMA 98ATEX1684 U

10...240 mm² /
 25...240 mm² /
 14

Type	Qty.	Order No.
WFF 185	4	1028600000
WFF 185/AH	2	1029600000
WFF 185 BL	4	1028680000

1000 V UL and CSA for usage groups B and C; can be used with isolating DIN rails and when using WTW-type partitions.

Type	current	Qty.	Order No.
WQL 2 WFF185	415 A	5	1065200000
WQL 3 WFF185	415 A	5	1065700000
Width			
WTW WFF185/300	2 mm	10	1067400000
WEW 35/1	12 mm	50	1059000000
WAH 185/300 BE	54 mm	10	1064760000
WD 1 25 K KARTE A 6 ST		5	1563900000

WS 12/6,5

WAH 185/300 in blue, Order no. 1064780000

WFF 300

300 mm²

Screw thread M16

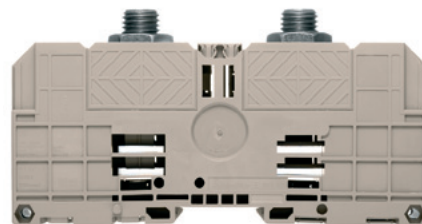

55 x 163 x 94
520 / 300
25...300



Ex e II II 2 G D

IEC	UL	CSA	EN 60079-7
1000	1000 (C)	600 (C)	1100
520	500 (C)	510 (C)	452
300	AWG 6...600	AWG 6...600	300

8 kV / 3
 / V-0

KEMA 98ATEX1684 U

25...240 mm² /
 50...300 mm² /
 25

Type	Qty.	Order No.
WFF 300	4	1028700000
WFF 300/AH	2	1029700000

1000 V UL and CSA for usage groups B and C; can be used with isolating DIN rails and when using WTW-type partitions.

Type	current	Qty.	Order No.
WQL 2 WFF300	520 A	5	1065300000
WQL 3 WFF300	520 A	5	1065800000
Width			
WTW WFF185/300	2 mm	10	1067400000
WEW 35/1	12 mm	50	1059000000
WAH 185/300 BE	54 mm	10	1064760000
WD 1 25 K KARTE A 6 ST		5	1563900000

WS 12/6,5

WAH 185/300 in blue, Order no. 1064780000

Accessories for stud terminals

Potential distribution

The power distribution between neighbouring stud terminals can be achieved simply with the use of 2- and 3-pole cross-connections (see the section under stud terminals). However, a cross-section reduction is required in special cases. These so-called cross-connection lugs are available for thread sizes from M6 to M10 and can be combined as required. This is helpful for power supplies and power distribution, for example.

WQL

Special cross-connection lugs

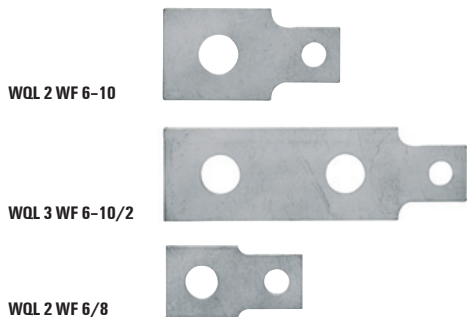

Type	Current [A]	Qty.	Order No.	Primary stud connection [M...]	Neighbouring stud connection [M...]
WQL 2 WF 6-10 t = 4 mm	125	5	1806620000	WF 6 = 1 pole M 6	1 x WF 10 = 1 pole M 10
WQL 3 WF 6-10/2 t = 4 mm	125	5	1806640000	WF 6 = 1 pole M 6	2 x WF 10 = 2 poles M 10
WQL 2 WF 6/8 t = 4 mm	125	5	1808980000	WF 6 = 1 pole M 6	1 x WF 8 = 1 pole M 8
WQL 4 WF 8-6/3 t = 4 mm	125	5	1904960000	WF 8 = 1 pole M 8	3 x WF 6 = 3 poles M 6

Potential distribution from stud terminals M10 to 2 x M6

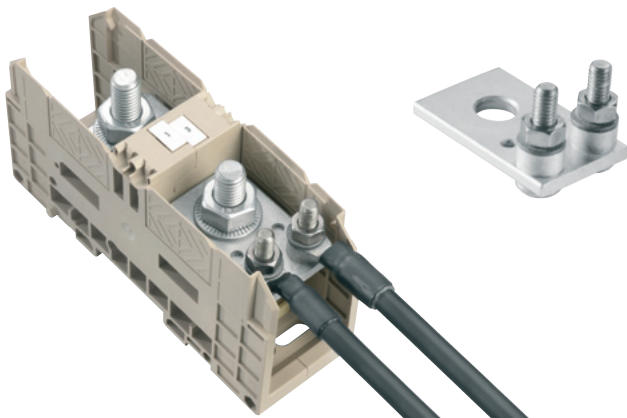

Type	Qty.	Order No.
SMSE WF10/2xM6	10	1868880000

Hole diameter: 10 mm for M10 bolts
Stud terminals: WF 10... and WFF 120
The nominal current depends on the test assembly.

WF



Cross-connections

Type	Current	Qty.	Order No.
WF 5			
2-pole WQL WF5	101 A	5	1812710000
3-pole WQL WF5	101 A	5	1812740000
WF 6			
2-pole WQL 2 WF6	125 A	5	1780970000
3-pole WQL 3 WF6	125 A	5	1780980000
WF 8			
2-pole WQL 2 WF8	150 A	5	1780990000
3-pole WQL 3 WF8	150 A	5	1781000000
WF 10			
2-pole WQL 2 WF10	265 A	5	1781010000
3-pole WQL 3 WF10	265 A	5	1781020000
4-pole WQL 4 WF10	265 A	5	1027840000
WF 12			
2-pole WQL 2 WF12	265 A	5	1781030000
3-pole WQL 3 WF12	265 A	5	1781040000
WF 6/2BZ			
2-pole WQL 2 WF6	125 A	5	1780970000
3-pole WQL 3 WF6	125 A	5	1780980000
WF 8/2BZ			
2-pole WQL 2 WF8	150 A	5	1780990000
3-pole WQL 3 WF8	150 A	5	1781000000
WF 10/2BZ			
2-pole WQL 2 WF10	265 A	5	1781010000
3-pole WQL 3 WF10	265 A	5	1781020000
WFF 35			
2-pole WQL 2 WFF35	150 A	5	1064900000
3-pole WQL 3 WFF35	150 A	5	1065400000
WFF 70			
2-pole WQL 2 WFF70	232 A	5	1065000000
3-pole WQL 3 WFF70	232 A	5	1065500000
WFF 120			
2-pole WQL 2 WFF120	309 A	5	1065100000
3-pole WQL 3 WFF120	309 A	5	1065600000
WFF 185			
2-pole WQL 2 WFF185	415 A	5	1065200000
3-pole WQL 3 WFF185	415 A	5	1065700000
WFF 300			
2-pole WQL 2 WFF300	520 A	5	1065300000
3-pole WQL 3 WFF300	520 A	5	1065800000

WF-series partitions



Type	Colour	Width	Qty.	Order No.
WTW WF6-WF12	dark beige Wemid	2.5 mm	20	1781240000
WTW WF6	dark beige Wemid	2 mm	20	1781220000
WTW WF8	dark beige Wemid	2 mm	20	1780900000
WTW WF10/WF12	dark beige Wemid	2 mm	20	1780890000

WFF-series partitions



Type	Width	Qty.	Order No.
WTW WFF35	2 mm	10	1067100000
WTW WFF70	2 mm	10	1067200000
WTW WFF120	2 mm	10	1067300000
WTW WFF185/300	2 mm	10	1067400000

Hood, transparent



Type	Colour	Qty.	Order No.
WAH 35	dark beige Wemid	20	1064460000
WAH 70 BE	dark beige Wemid	20	1064560000
WAH 120	dark beige Wemid	20	1064660000
WAH 185/300 BE	dark beige Wemid	10	1064760000

WF-series 2300 V partitions



Type	Colour	Width	Qty.	Order No.
WTW WF6 2300	beige, Epoxy resin	2 mm	20	1781230000
WTW WF8 2300	beige, Epoxy resin	2 mm	20	1780910000
WTW WF10/WF12 2300	beige, Epoxy resin	2 mm	20	1780920000

Warning triangle for power supply terminals



Type	Qty.	Order No.
WD 1 25 K KARTE A 6	5	1563900000

Twin stud terminals - ST 4000

ST 4000 (up to 4 kV)

In hazardous area applications, the installation instructions and the rated data specifications for accessories given in the technical appendix must be followed.

Width/Length/Height of lowest version	mm
max. current / max. cond. cross-section	A/mm ²
Max. clamping range	mm ²

Technical data

Rated data with Wemid partition wall	
Rated voltage	V
Rated current	A
Rated cross-section	mm ²
Rated impulse withstand voltage / Pollution severity	
Gauge to IEC 60947-1 / Flammability class UL94	
Approvals	

Clamped cable lugs	
Cable lug to DIN 46234	
2 x cable lugs DIN 46 234	
Cable lug to DIN 46235	
2 x cable lugs DIN 46 235	
Tightening torque range	

Note

Ordering data

Version	
	red
	with internal thread

Note

Accessories

Cross-connection	
	2-pole
	3-pole
	4-pole
Busbar	
	M8 / 4 mm thick
	M10 / 4 mm thick
	M10 / 6 mm thick
	M12 / 4 mm thick
	M12 / 6 mm thick
Connecting piece	
	130 mm length
	160 mm length
Partition plate	
	150 mm length
	180 mm length
End partition	
	150 mm length
	180 mm length
Touch-safe protection	
	150 mm length
	180 mm length

(see assortment in catalogue 7)

Note

ST 4000/S M8

120 mm²

Screw thread M8



40 x 150 x 84	
269 /	

IEC	UL	CSA
4000		
269		
120		
	30 kV / 3	
	/ V-0	
1.5 - 120 mm ²		
16...70 mm ²		
6...12 Nm		
Rated voltage when using cable lugs according to DIN 46234		

Type	Qty.	Order No.
ST 4000/S M8	25	1809110000
ST 4000/S M8 F	25	1809120000
Weidmüller creates drawings according to the customer specified ST 4000 application.		

Type	current	Qty.	Order No.
ST 4000/S J2 M8		100	1809310000
ST 4000/S J3 M8		50	1809320000
Width			
ST 4000/S CB M8/4		100	1809250000
ST 4000/S C130			
ST 4000/S C130		50	1809230000
ST 4000/S P150			
ST 4000/S P150	10 mm	50	1809190000
ST 4000/S E150			
ST 4000/S E150	10 mm	50	1809210000
ST 4000/S S150			
ST 4000/S S150		20	1809470000

ST 4000/S M10

120 mm²

Screw thread M10



40 x 150 x 84	
269 /	
...	

IEC	UL	CSA
4000		
269		
120		
	30 kV / 3	
	/ V-0	
4 - 120 mm ²		
10...20 Nm		
Rated voltage when using cable lugs according to DIN 46234		

Type	Qty.	Order No.
ST 4000/S M10	25	1809130000
ST 4000/S M10 F	25	1809140000
Weidmüller creates drawings according to the customer specified ST 4000 application.		

Type	current	Qty.	Order No.
ST 4000/S J2 M10		100	1809340000
ST 4000/S J3 M10		50	1809350000
ST 4000/S J4 M10		25	1809360000
Width			
ST 4000/S CB M10/4		100	1809260000
ST 4000/S CB M10/6		100	1809270000
ST 4000/S C130			
ST 4000/S C130		50	1809230000
ST 4000/S P150			
ST 4000/S P150	10 mm	50	1809190000
ST 4000/S E150			
ST 4000/S E150	10 mm	50	1809210000
ST 4000/S S150			
ST 4000/S S150		20	1809470000

ST 4000/L M10

150 mm²

Screw thread M10



55 x 180 x 90

309 /

...



IEC	UL	CSA
4000		
309		
150		
29.5 kV / 3		
/ V-0		
10 - 150 mm ²		
25 - 150 mm ²		
10...20 Nm		
Rated voltage when using cable lugs according to DIN 46234		

Type	Qty.	Order No.
ST 4000/L M10	15	1809150000
ST 4000/L M10 F	15	1809160000
Weidmüller creates drawings according to the customer specified ST 4000 application.		

Type	current	Qty.	Order No.
ST 4000/L J2 M10		50	1809370000
Width			
ST 4000/L CB M10/4		100	1809280000
Width			
ST 4000/L C160		50	1809240000
ST 4000/L P180	10 mm	50	1809200000
ST 4000/L E180	10 mm	50	1809220000
ST 4000/L S180		1	1809480000

ST 4000/L M12

240 mm²

Screw thread M12



55 x 180 x 90

415 /

...



IEC	UL	CSA
4000		
415		
240		
29.5 kV / 3		
/ V-0		
10...240 mm ²		
25...240 mm ²		
14...31 Nm		
Rated voltage when using cable lugs according to DIN 46234		

Type	Qty.	Order No.
ST 4000/L M12	15	1809170000
ST 4000/L M12 F	15	1809180000
Weidmüller creates drawings according to the customer specified ST 4000 application.		

Type	current	Qty.	Order No.
ST 4000/L J2 M12		50	1809400000
ST 4000/L J3 M12		50	1809410000
ST 4000/L J4 M12		25	1809420000
Width			
ST 4000/L CB M12/4		100	1809290000
ST 4000/L CB M12/6		100	1809300000
ST 4000/L C160		50	1809240000
ST 4000/L P180	10 mm	50	1809200000
ST 4000/L E180	10 mm	50	1809220000
ST 4000/L S180		1	1809480000

For assembly planning and accessories, please contact our customer-specific solutions division. Also see Chapter V - Weidmüller Solutions & Services.

Extra functions

Weidmüller offers the user of W-Series terminals a comprehensive range of accessories, providing optimum solutions to every conceivable task – even outside the range of standard functions.

All Weidmüller accessories are built to the same high quality standards as the terminals themselves.

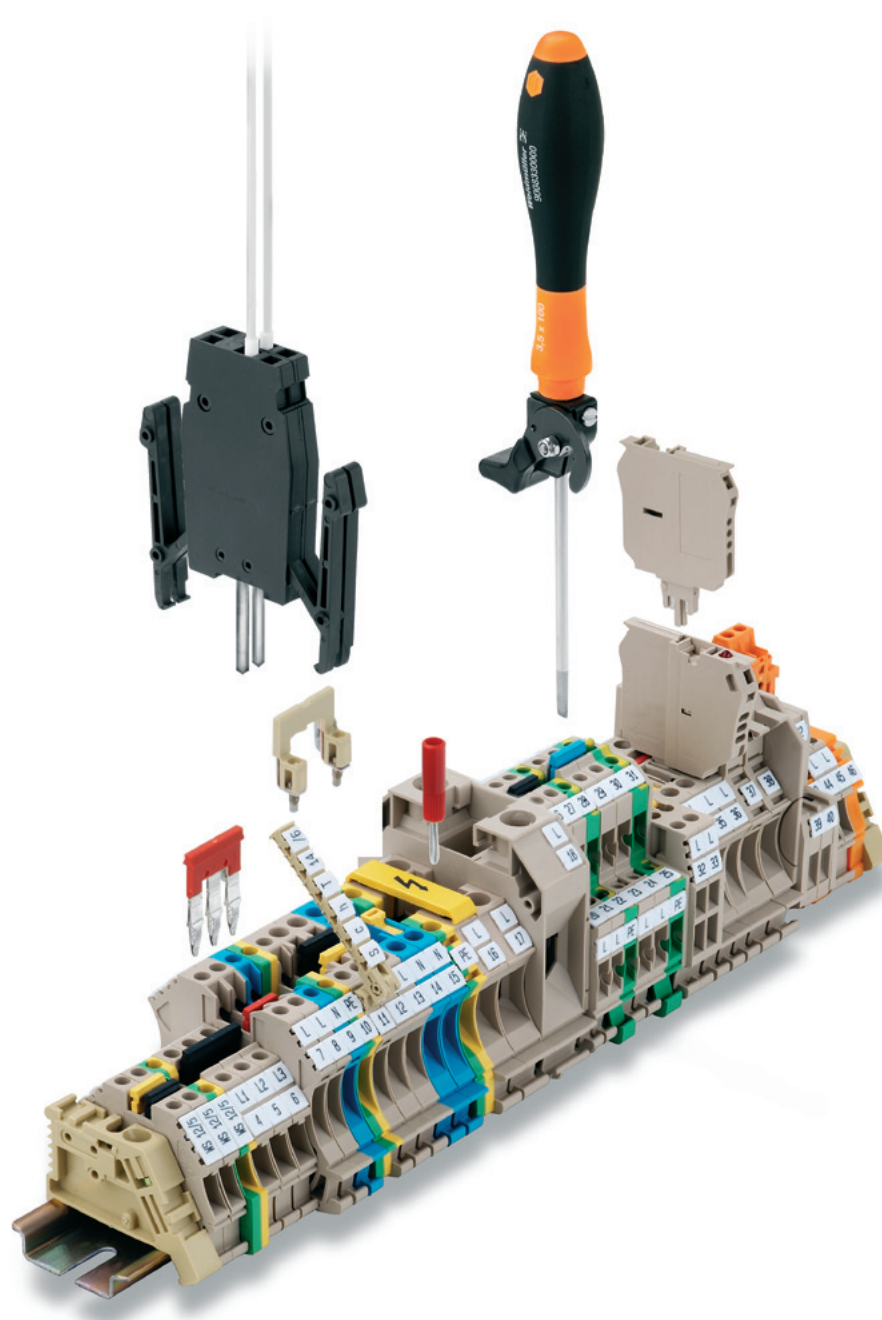

Visual separation – Side covers

Page D.156



To guarantee “finger-safe” use of terminals, the open sides are covered with end plates and partition plates to prevent any contact with conducting parts.

End plates and partition plates also come in different colours so that they can be used for visual separation of different circuits.

Labelling

Page D.176

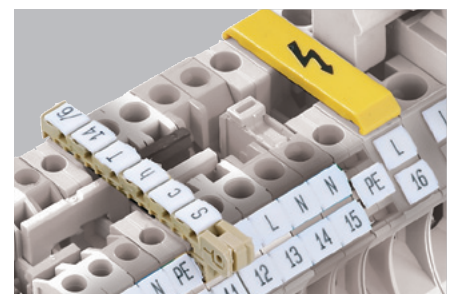

Weidmüller’s labelling systems in **chapter F** are used to label screw terminals.

Individual clamping points, terminal groups and conductors can be marked. The cover (WAD) can also be used for labelling mains supply points (see page **D.168**)

Fastening

Chapter F

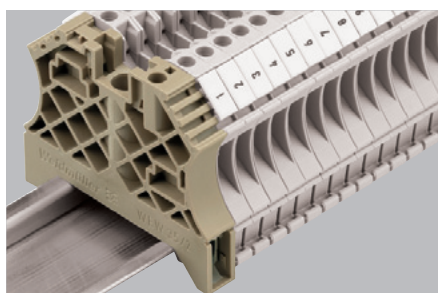

An end bracket is fitted on the terminal rail to the right and left of the terminals to ensure that they sit firmly in position. The marking surface of the end bracket can also be used for group marking. Details of the wide range of Weidmüller end brackets and mounting rails are given in **chapter F**.

Power supply

Page D.160

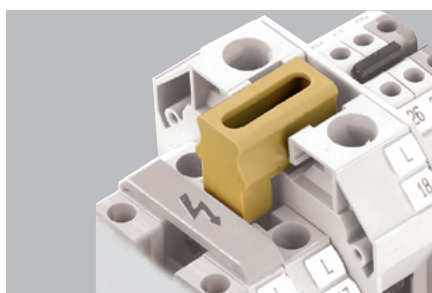

For the W-Series, power is supplied via standard terminals in conjunction with a special cross-connection, which directly connects terminals for larger and smaller cross-sections (the picture shows WDU 35 on WDU 4). It is possible to form a link to screw-in cross-connections of smaller cross-sections (WQV 2.5/4/6). This extends current distribution to any number of other terminals of the smaller cross-section.

Current distribution

Page D.164

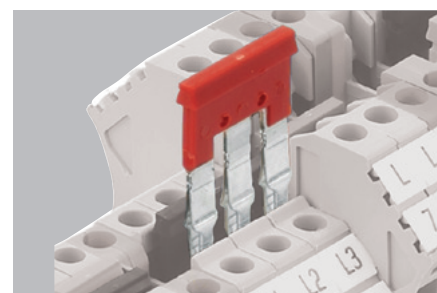

A screw-in and a plug-in cross-connection system is available for Weidmüller screw terminals. The plug-in **cross-connection (ZQV)** for screw terminals is unique. It enables considerable reductions in assembly times. The plug-in cross-connections can be used for nearly all W-Series terminals in the cross-section ranges 2.5 and 4 mm².

Connecting

Chapter F

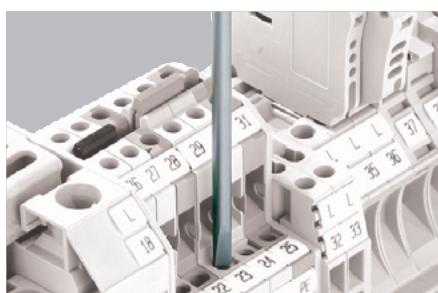

Conductors are connected into Weidmüller terminals using standard screwdrivers, as shown in **chapter F**,

Testing / checking

Page D.173

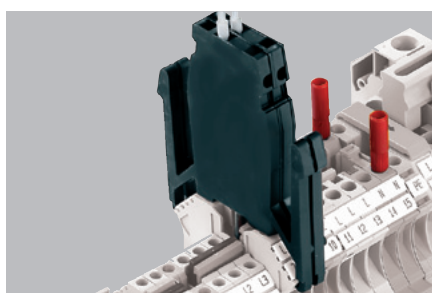

The slot-in test adapter (WTA) is used as both a single unit and a test adapter strip for measurement in control cabinets. The test adapter is ideal for convenient, rational testing of assembled terminals. However, tests with socket and test plugs are also possible (Page D.173).

Specific functions / colour variations

Page D.177

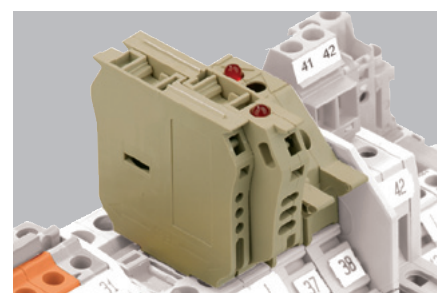

Further helpful accessories are available for terminals using screw clamp technology, such as:

- Pluggable fuse holder (SIHA 1 and SIHA 2)
- Screen plug (LS), short-cir. plug (WDS)
- Extension connectors (WZAD)
- PEN bridges
- Accessories for disconnect test terminals
- Terminals in various colours
- Pre-fitted **terminal blocks**

End plates

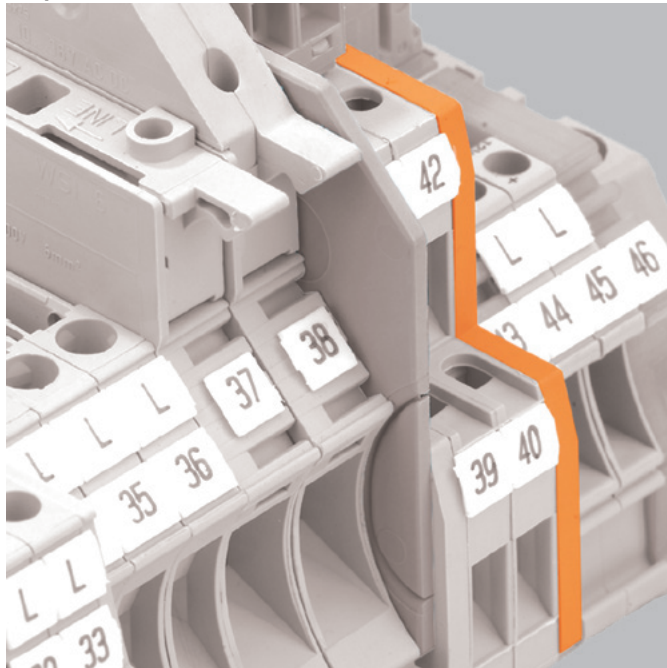

Touch protection

With only a few exceptions, the last terminal in a terminal strip must be closed off with a WAP/AP-type end plate. End plates must also be used within a terminal strip when it makes use of terminals of different sizes. This ensures the touch-safe requirement is met for live voltage components. The terminals are touch-safe (DIN EN 50274).

Optical separation

Coloured end plates are frequently used for distinguishing the circuits visually.

Ensuring the operating voltage

End plates can also be used to maintain the required clearance and creepage distances, in order to guarantee the rated voltage for the application. They can be used when cross-connections are used side-by-side.

Contour matching

The overall dimensions of the end plates match the external dimensions of the associated terminal.

Mounting

The end plate's snap-in pegs allow it to be simply fitted on to the corresponding terminal. The corresponding indentations in the terminal are used to ensure that position follows the identical contours. All colour variations are classified according to UL94 V-0.

Ordering data

Type Width	Colour	Qty.	Order No.	For terminal:
WAP 2.5-10	dark beige	50	1050000000	WDU 1.5/ZZ
WAP 2.5-10 BL	blue/light blue	50	1050080000	WDU 1.5/ZZ BL
WAP 2.5-10 BR	brown	50	1050070000	WDU 10
WAP 2.5-10 GE	yellow	50	1050020000	WDU 10 BL
WAP 2.5-10 GN	green	50	1072200000	WDU 10 SL
WAP 2.5-10 GR	grey	50	1050050000	WDU 10 SL/EN
WAP 2.5-10 OR	orange	50	1050060000	WDU 10 SL/EN SW
WAP 2.5-10 RT	red	50	1050040000	WDU 2.5
WAP 2.5-10 SW	black	50	1050010000	WDU 2.5 BL
WAP 2.5-10 VI	violet	50	1072210000	WDU 2.5 F 2X2.8
WAP 2.5-10 WS	white	50	1050090000	WDU 2.5 FF 2*2.8
WAP 2.5-10/0.5 mm	transparent	50	1966380000	WDU 2.5/1.5/ZR BL
				WDU 2.5/TC Type B
				WDU 2.5/TC Type E
				WDU 2.5/TC Type J
				WDU 2.5/TC Type K
				WDU 2.5/TC Type N
				WDU 2.5/TC Type SR
				WDU 2.5/TC Type T
				WDU 4
				WDU 4 BL
				WDU 4 SL
				WDU 4 SL/EN
				WDU 4 SL/EN SW
				WDU 6
				WDU 6 BL
				WDU 6 SL
				WDU 6 SL/EN
				WDU 6 SL/EN SW
				WDUL 4 100R/0.75W POTI
				WDUL 4 10K/0.75W POTI
				WDUL 4 10R/0.75W POTI
				WDUL 4 1K/0.75W POTI
				WDUL 4 500K/0.1W POTI
				WDUL 4 500R/0.75W POTI
				WDUL 4 50K/0.75W POTI
				WDUL 4 5K/0.75W
				WDUL 4 OHNE POTI
				WNT 10 10X3
				WNT 10 10X3 BE
				WNT 2.5 10X3
				WNT 2.5 10X3 BE
				WNT 4 10X3
				WNT 4 10X3 BE
				WNT 6 10X3
				WNT 6 10X3 BE
				WPE 1.5/ZZ
				WPE 10
				WPE 2.5

Ordering data

Type	Colour	Qty.	Order No.	For terminal:
WAP 16+35 WTW 2.5-10	dark beige	20	1050100000	WDK 2.5 / 800V
WAP 16+35 WTW 2.5-10 BL	blue/light blue	20	1050180000	WDK 2.5 FF
WAP 16+35 WTW 2.5-10 OR	orange	20	1050160000	WDU 1.5/ZZ
Width				
WAP WDK2.5	dark beige	20	1059100000	WDK 2.5
WAP WDK2.5 BL	blue/light blue	20	1059180000	WDK 2.5 DU-PE
WAP WDK2.5 GN	green	20	1059140000	WDK 2.5 F
Width				
WAP WDK2.5 BL	blue/light blue	20	1059180000	WDK 2.5 F BL
Width				
WAP WDK2.5 BL	blue/light blue	20	1059180000	WDK 2.5 FF
Width				
WAP WDK2.5 BL	blue/light blue	20	1059180000	WDK 2.5 FV
Width				
WAP WDK2.5 BL	blue/light blue	20	1059180000	WDK 2.5 LD GR 1R 24VDC
Width				
WAP WDK2.5 BL	blue/light blue	20	1059180000	WDK 2.5 LD GR 1R 24VDC
Width				
WAP WDK2.5 BL	blue/light blue	20	1059180000	WDK 2.5 LD ROT 1R 24VDC
Width				
WAP WDK2.5 BL	blue/light blue	20	1059180000	WDK 2.5 LD ROT 1R 24VDC
Width				
WAP WDK2.5 BL	blue/light blue	20	1059180000	WDK 2.5 PE
Width				
WAP WDK2.5 BL	blue/light blue	20	1059180000	WDK 2.5 / 800V
Width				
WAP WDK2.5 BL	blue/light blue	20	1059180000	WDK 2.5 ZQV
Width				
WAP WDK2.5 BL	blue/light blue	20	1059180000	WDK 2.5 ZQV BL
Width				
WAP WDK2.5 BL	blue/light blue	20	1059180000	WDK 2.5/D
Width				
WAP WDK2.5 BL	blue/light blue	20	1059180000	WDK 2.5V
Width				
WAP WDK2.5 BL	blue/light blue	20	1059180000	WDK 2.5V BL
Width				
WAP WDK2.5 BL	blue/light blue	20	1059180000	WDK 2.5 1D A.1
Width				
WAP WDK2.5 BL	blue/light blue	20	1059180000	WDK 2.5 1D A.2
Width				
WAP WDK2.5 BL	blue/light blue	20	1059180000	WDK 2.5 2D
Width				
WAP WDK2.5 BL	blue/light blue	20	1059180000	WDK 2.5 2D
Width				
WAP WDK2.5 BL	blue/light blue	20	1059180000	WDK 2.5 2D
Width				
WAP WDK2.5 BL	blue/light blue	20	1059180000	WDK 2.5 BL
Width				
WAP WDK2.5 BL	blue/light blue	20	1059180000	WDK 2.5 D

Ordering data

Type	Colour	Qty.	Order No.	For terminal:
WAP WTR2.5/ZZ	dark beige	20	1074600000	WTR 2.5/ZZ
WAP WTR2.5/ZZ BL	blue/light blue	20	1074680000	WTR 2.5/ZZ BL
WAP WDK2.5/BLZ/O.ZA LG	light grey	20	1112130000	
Width				
WAP WDU/WTR4/ZR	dark beige	50	1905070000	WDU 4/ZR
WAP WDU/WTR4/ZZ	dark beige	50	1905150000	WDU 4/ZZ
Width				
WAP WDU/WTR4/ZZ	dark beige	50	1905150000	WPE 4/ZR
Width				
WAP WDU/WTR4/ZZ	dark beige	50	1905150000	WPE 4/ZZ
Width				
WAP WDU/WTR4/ZZ	dark beige	50	1905150000	WTR 4/ZZ
Width				
WAP WDU/WTR4/ZZ	dark beige	50	1905150000	WTR 4/ZZ STB
Width				
WAP WDU/WTR4/ZZ	dark beige	50	1905150000	WTR 4/ZZ
Width				
WAP WDU/WTR4/ZZ	dark beige	50	1905150000	WTR 4/ZZ STB
Width				
WAP WDL2.5/S	dark beige	20	1067700000	WDL 2.5/S/L
Width				
WAP WDL2.5/S	dark beige	20	1067700000	WDL 2.5/S/L/L
Width				
WAP WDL2.5/S	dark beige	20	1067700000	WDL 2.5/S/L/L/PE
Width				
WAP WDL2.5/S	dark beige	20	1067700000	WDL 2.5/S/N/L/PE
Width				
WAP WDL2.5/S	dark beige	20	1067700000	WDL 2.5/S/NT/L/PE
Width				
WAP WDL2.5	beige	20	1067800000	WDL 2.5/L
Width				
WAP WDL2.5	beige	20	1067800000	WDL 2.5/L/L
Width				
WAP WDL2.5	beige	20	1067800000	WDL 2.5/L/L/PE
Width				
WAP WDL2.5	beige	20	1067800000	WDL 2.5/N/L/PE
Width				
WAP WDL2.5	beige	20	1067800000	WDL 2.5/NT/L/PE
Width				
WAP WDU1.5/BLZ	dark beige	50	1577330000	WDU 1.5/BLZ 5.08
WAP WDU1.5/BLZ/ZA	dark beige	50	1577320000	WDU 1.5/ZQV/BLZ 5.08
Width				
WAP WDU1.5/BLZ/ZA	dark beige	50	1577320000	WDU 2.5/BLZ/7.62
Width				
WAP WDK2.5/BLZ/M.ZA	blue	20	1070100000	WDK 2.5 BLZ/5.08/ZA
WAP WDK2.5/BLZ/O.ZA	dark beige	20	1070000000	WDK 2.5 BLZ/7.62/ZA
Width				
AP DLI2.5 DB	dark beige	20	1783550000	DLI 2.5 DB
Width				
AP DLI2.5 DB	dark beige	20	1783550000	DLI 2.5/D DB
Width				
AP DLI2.5 DB	dark beige	20	1783550000	DLI 2.5/LD-GN/D DB
Width				
AP DLI2.5 DB	dark beige	20	1783550000	DLI 2.5/LD-RT DB
Width				
AP DLI2.5 DB	dark beige	20	1783550000	DLI 2.5 DB
Width				
AP DLI2.5 DB	dark beige	20	1783550000	DLI 2.5/LD-GN/NPN -> DB
Width				
AP DLI2.5 DB	dark beige	20	1783550000	DLI 2.5/LD-GN/PNP -> DB
Width				
AP DLI2.5 DB	dark beige	20	1783550000	DLI 2.5/LD-RT/NPN -> DB
Width				
AP DLI2.5 DB	dark beige	20	1783550000	DLI 2.5/LD-RT/PNP -> DB
Width				
AP DLD2.5 DB	dark beige	20	1784210000	DLD 2.5 DB
AP DLD2.5/PE DB	dark beige	20	1783800000	DLD 2.5/PE DB
Width				
WAP WTL6/1	dark beige	20	1068300000	WTD 6/1 EN
Width				
WAP WTL6/1	dark beige	20	1068300000	WTL 6/1 EN
Width				
WAP WTL6/1	dark beige	20	1068300000	WTL 6/1 EN STB
Width				
WAP WTL6/1	dark beige	20	1068300000	WTL 6/1/STB/TNSC/EN
Width				
WAP WTL6/1	dark beige	20	1068300000	WTQ 6/1 EN
Width				
WAP WTL6/1	dark beige	20	1068300000	WTQ 6/1 EN STB
Width				
ZAP/TW 1	dark beige	50	1608740000	WTL 4
ZAP/TW 1 BL	blue/light blue	50	1608750000	WTL 4/STB
ZAP/TW 1 GN	green	50	1683680000	
ZAP/TW 1 GR	grey	50	1683710000	
ZAP/TW 1 OR	orange	50	1608760000	
ZAP/TW 1 RT	red	50	1683660000	
Width				
WAP WDU1.5/R3.5	beige	20	1754190000	WDK 1.5/R3.5
Width				
WAP WDU1.5/R3.5	beige	20	1754190000	WDK 1.5/R3.5 BL
Width				
WAP WDU1.5/R3.5	beige	20	1754190000	WDU 1.5/R3.5
Width				
WAP WDU1.5/R3.5	beige	20	1754190000	WDU 1.5/R3.5 BL
Width				
WAP WDU1.5/R3.5	beige	20	1754190000	WPE 1.5/R3.5
Width				
WAP WDK1.5/R3.5	dark beige	20	1754200000	WDK 1.5/R3.5
Width				
WAP WDK1.5/R3.5	dark beige	20	1754200000	WDK 1.5/R3.5 BL
Width				
AP AKZ1.5	beige	50	0340560000	AKZ 1.5
AP AKZ1.5 BL	blue	50	0340580000	AKZ 1.5 BL
Width				
AP AKZ2.5	beige	50	0697360000	AKZ 2.5
AP AKZ2.5 BL	blue	50	0697380000	AKZ 2.5 BL

Ordering data

Type	Colour	Qty.	Order No.	For terminal:
Width				
ADL	beige	2	0210800000	AKZ 4
AP AKZ4 DB	beige	20	9537910000	AKZ 4 BL
AP 100 GR	grey	20	1773410000	
AP AKZ4	beige	20	0294460000	
AP AKZ4 BL	blue	20	0294480000	
AP AKZ4 KRG	dark beige/yellow	20	0294420000	
AP AKZ4 KRS	anthracite	20	0294430000	
Width				
WAP WDU2.5N/4N	dark beige	50	1060000000	WDU 2.5N
WAP WDU2.5N/4N BL	blue/light blue	50	1060080000	WDU 2.5N BL
WAP WDU2.5N/4N GE	yellow	50	1060090000	WDU 2.5N ZQV
WAP WDU2.5N/4N OR	orange	50	1060060000	WDU 2.5N ZQV BL
				WDU 4N
				WDU 4N BL
				WPE 2.5N
				WPE 4N
Width				
WAP WDK2.5/4 N	dark beige	20	1084000000	WDK 2.5N
WAP WDK2.5/4 N BL	orange	20	1084080000	WDK 4N V
				WDK 2.5N DU-PE
				WDK 2.5N PE
				WDK 2.5N V
				WDK 2.5N/BL
				WDK 4N
				WDK 4N BL
				WDK 4N DU-PE
				WDK 4N PE
Width				
WAP WTL6/3	beige	20	1879910000	WTL 6/3
Width				
WAP WTL 6 SL	beige	20	9538110000	WTD 6 SL
				WTD 6 SL/EN
				WTL 6 SL
				WTL 6 SL/EN
				WTL 6 SL/EN SW
Width				
WAP WTL4/2	beige	50	1881640000	WTL 4/2/STB
Width				
WAP WTL6/4FF	beige	20	1887240000	WTL 6/4FF
Width				
WAP WSI4/2	beige	50	1880450000	WSI 4
				WSI 4/LD 60-150V AC/DC
				WSI 4/2
				WSI 4/2/LD 10-36V AC/DC
				WSI 4/2/LD 140-250V AC/DC
				WSI 4/2/LD 30-70V AC/DC
				WSI 4/2/LD 60-150V AC/DC
				WSI 4/LD 10-36V AC/DC
				WSI 4/LD 140-250V AC/DC
				WSI 4/LD 30-70V AC/DC
Width				
AP VLI1.5 DB	dark beige	20	1784150000	VLI 1.5
AP VLI1.5/PE DB	dark beige	20	1784160000	VLI 1.5 DB
				VLI 1.5/PE
				VLI 1.5/PE DB
Width				
AP MAK2.5 DB	dark beige	20	7917000000	MAK 2.5
				MAK 2.5 DB
Width				
WAP WFF120	dark beige	20	1073000000	WFF 120
WAP WFF35	dark beige	20	1069700000	WFF 70/AH
WAP WFF70	dark beige	20	1069800000	WFF 120 BL
				WFF 120/3/B
				WFF 120/AH
				WFF 35
				WFF 35 BL
				WFF 35/AH
				WFF 70
				WFF 70 BL

Partition walls

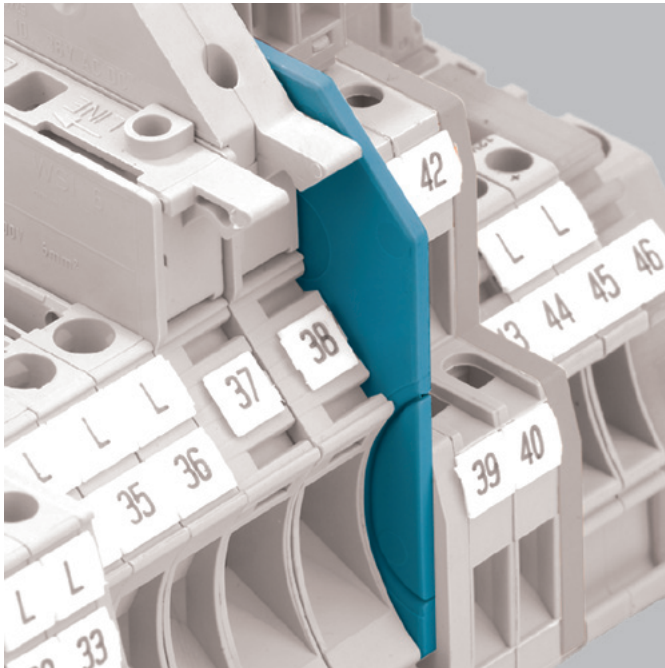

Ensuring the operating voltage

The main function of the partitions is to maintain the clearance and creepage distances, as required by the operating voltage. This includes applications with higher security levels (ATEX) or neighbouring groups of cross-connections. For this reason, the partitions are significantly larger than the corresponding terminals.

Optical separation

The partitions can be used to achieve a very clear separation of circuits on one terminal strip.

Dimensions

WAP 16+35 WTW 2.5-10

Length: 60 mm
Height with TS 35 x 7.5: 63 mm

WTW EN

Length: 86 mm
Height with TS 35 x 7.5: 63 mm

Ordering data

Type	Colour	Qty.	Order No.	For terminal:
WAP 16+35 WTW 2.5-10	dark beige	20	1050100000	WDK 2.5 / 800V
WAP 16+35 WTW 2.5-10 BL	blue/light blue	20	1050180000	WDK 2.5 FF
WAP 16+35 WTW 2.5-10 OR	orange	20	1050160000	WDU 1.5/ZZ
				WDU 1.5/ZZ BL
				WDU 10
				WDU 10 BL
				WDU 10 SL
				WDU 10 SL/EN
				WDU 10 SL/EN SW
				WDU 10/ZR
				WDU 10/ZR BL
				WDU 16/ZA
				WDU 16/ZA BL
				WDU 2.5
				WDU 2.5 BL
				WDU 2.5 F 2X2.8
				WDU 2.5 FF 2*2.8
				WDU 2.5/1.5/ZR
				WDU 2.5/1.5/ZR BL
				WDU 2.5/TC Type B
				WDU 2.5/TC Type E
				WDU 2.5/TC Type J
				WDU 2.5/TC Type K
				WDU 2.5/TC Type N
				WDU 2.5/TC Type SR
				WDU 2.5/TC Type T
				WDU 2.5N/600 UL
				WDU 35/IK/ZA
				WDU 4
				WDU 4 BL
				WDU 4 SL
				WDU 4 SL/EN
				WDU 4 SL/EN SW
				WDU 6
				WDU 6 BL
				WDU 6 SL
				WDU 6 SL/EN
				WDU 6 SL/EN SW
				WDUL 4 100R/0,75W POTI
				WDUL 4 10K/0,75W POTI
				WDUL 4 10R/0,75W POTI
				WDUL 4 1K/0,75W POTI
				WDUL 4 500K/0,1W POTI
				WDUL 4 500R/0,75W POTI
				WDUL 4 50K/0,75W POTI
				WDUL 4 5K/0,75W
				WDUL 4 OHNE POTI
				WPE 1.5/ZZ
				WPE 10
				WSI 6
Width				
WTW EN	dark beige	20	1058800000	SAKS 2/35 DB
				WDK 2.5N DU-PE
				WDK 2.5N PE
				WDK 2.5N V
				WDK 2.5N/BL
				WDK 2.5V
				WDK 2.5V BL
				WDK 4N PE
				WDU 16N
				WDU 16N BL
				WDU 35N
				SAKS 4/35 DB
				WDU 35N BL
				WTD 6 SL
				WTD 6 SL/EN
				WTL 6 SL
				WTL 6 SL/EN
				WTL 6 SL/EN SW
				SAKS 5/35 DB
				WDK 2.5
				WDK 2.5 BL
				WDK 2.5 DU-PE
				WDK 2.5 ZQV
				WDK 2.5 ZQV BL
				WDK 2.5N

Potential supply with cross-section reduction

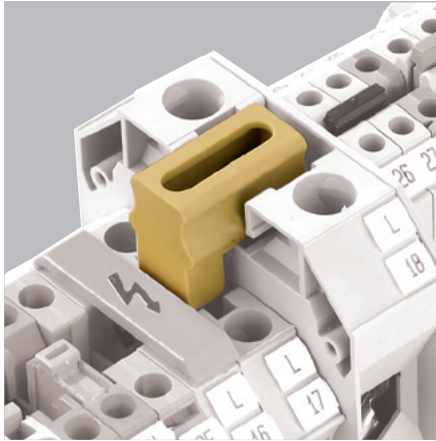

Mounting

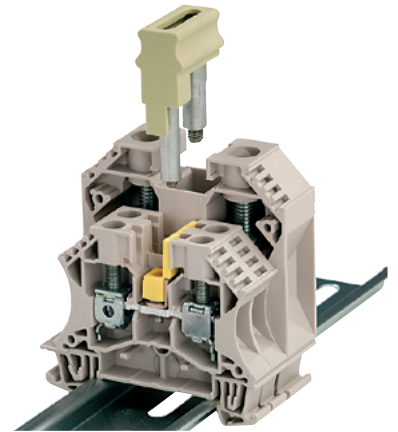

Feed-through terminals such as WDU 35 or WDU 16 are responsible for power supply in the W-Series. The current is routed by the cross-connections shown to terminals of a smaller cross-section (cross-section reduction). After cross-section reduction, the supply can then be distributed on to any number of terminals of this same cross-section, using standard cross-connectors.

Function

- Larger conductor cross-section can be used for power supply
- Central current supply and distribution to any number of circuits

First, prepare the **standard cross-connection** that is to distribute the current to other terminals of smaller conductor cross-section. To do so, break off the plastic screwdriver guide at the first pole of the cross-connection by bending it back and forth at the intended break-off point, and remove the fixing screw. Then place the cross-connection in the middle of the terminal.

Now insert the **cross-connection for cross-section reduction** so that there is an overlap of the live parts of the first terminal of the smaller cross-section. Fasten with the screws in the cross-section reduction.

Important! The “QL” cross-section reductions are not finger-safe. This can be easily remedied by using the WAD covers for the corresponding terminals.

Potential supply with cross-section reduction

Power supply via

Output terminal

WDU 35

onto WDU 2.5



WDU 35

onto WDU 10



Technical data	
Continuous current 2-pole	A
Thread size	
Tightening torque	Nm
Ordering data	
	2-pole

to WDU 35	to WDU 2.5	
41		
M 4	M 2.5	
1.2 ... 1.8	0.4 ... 0.7	
Type	Qty.	Order No.
WQV 35-2.5	10	1064100000

to WDU 35	to WDU 10	
57		
M 4	M 3	
1.2 ... 1.8	0.5 ... 0.8	
Type	Qty.	Order No.
WQV 35-10	10	1068000000

Power supply via

Output terminal

WDU 16

WDU 2.5



Technical data	
Continuous current 2-pole	A
Thread size	
Tightening torque	Nm
Ordering data	
	2-pole

to WDU 16	to WDU 2.5	
41		
M 4	M 2.5	
1.2 ... 1.8	0.4 ... 0.7	
Type	Qty.	Order No.
WQV 16-2.5	10	1063900000

Power supply via

Output terminal

WDU 10

WDU 2.5



Technical data	
Continuous current 2-pole	A
Thread size	
Tightening torque	Nm
Ordering data	
	2-pole
Note	

to WDU 10	to WDU 2.5	
24		
M 3	M 2.5	
0.5 ... 0.8	0.4 ... 0.7	
Type	Qty.	Order No.
QL 10-2.5	10	1859620000
Note		
not finger-safe		

Note:
Cross-section reducing cross-connectors may **not** be used in ATEX applications.

Potential supply with cross-section reduction

Power supply via

Output terminal

WDU 16N

WDU 2.5



WDU 16N

WDU 4 / WDU 6



WDU 6

WDU 2.5



Technical data	
Continuous current 2-pole	A
Thread size	M 3
Tightening torque	Nm
Ordering data	
	2-pole
Note	

to WDU 16		to WDU 2.5	
24			
M 3		M 2.5	
0.5 ... 0.8		0.4 ... 0.7	
Type	Qty.	Order No.	
WQV 16N-2.5	10	1073100000	
Note			

to WDU 16N		to WDU 4 / 6	
41			
M 3		M 3	
0.5 ... 0.8		0.5 ... 0.8	
Type	Qty.	Order No.	
WQV 16N-4/6	10	1072500000	
Note			

to WDU 6		to WDU 2.5	
24			
M 3		M 2.5	
0.5 ... 0.8		0.4 ... 0.7	
Type	Qty.	Order No.	
Q WDU6-2.5 SET	10	1859600000	
Note			
not finger-safe			

Note:

Cross-section reducing cross-connectors may **not** be used in ATEX applications.

ZQV plug-in cross-connection

D

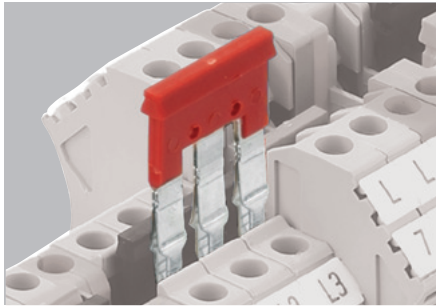

Weidmüller is the leading manufacturer of plug-in cross connection systems for screw clamp terminals. The plug-in cross-connections stand out with their easy handling and quick assembly, resulting in considerable time savings compared to screwed assembly solutions. This also ensures that all poles remain securely in contact.

Assembly / Technical information

- The ZQV is pressed into the cross-connection channel by hand.
- **Important!** Ensure that the ZQV is pressed right in. The cross-connection must not protrude out of the cross-connection channel.
- To replace or remove, simply lever out with a screwdriver.
- Finger-safe to VDE 0160 part 100 (VGB4)
- Reduced rated voltage 400 V
- Different colours can be used to mark different potential
- **Important!** The contact elements must not be deformed

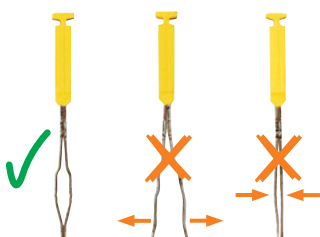

In one cross-connection channel

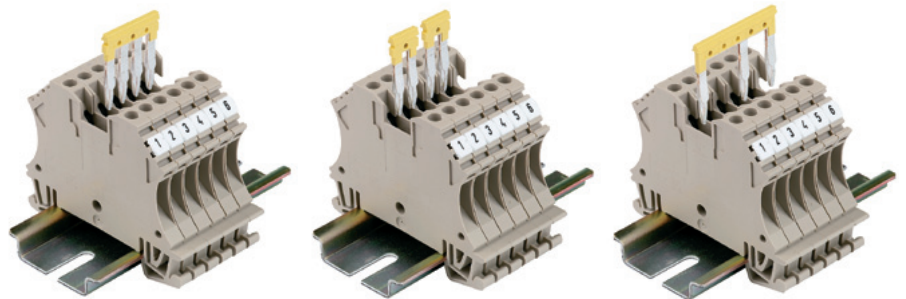

In two cross-connection channels

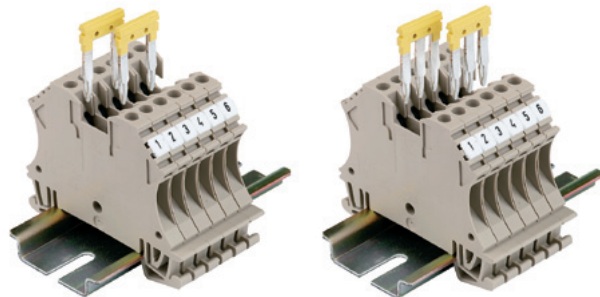

Possible cross-connections of terminals of the same type with corresponding cross-connectors

Terminal type	Cross-connector	single	adjacent	bridging	parallel bridging	parallel lengthening
Standard						
WDU 1.5/ R3.5	ZQV 1.5/ R3.5	•	•	•		
WDK 1.5/ R3.5	ZQV 1.5/ R3.5	•	•	•		
WDU 2.5/1.5/ZR	ZQV 2.5N	•	•	•	•	•
WDU 2.5	ZQV 2.5N	•	•	•	•	•
WDK 2.5 ZQV	ZQV 2.5N	•	•	•		
WTR 2.5/ZZ	ZQV 2.5	•	•	•		
WDU 4	ZQV 4N	•	•	•	•	•
WTR 4...	ZQV 4N	•	•	•		
WDU/PE/4ZZ/ZR	ZQV 4N	•	•	•	•	•
WTR 4/ZZ/ZR	ZQV 4N	•	•	•		
Compact						
WDU 2.5N ZQV	ZQV 2.5N	•	•	•	•	•
WDK 2.5N...	ZQV 2.5N	•	•	•		
WDK 2.5N PE	ZQV 2.5N	•	•	•		
WDU 4N	ZQV 4N	•	•	•	•	•
WDK 4N...	ZQV 4N	•	•	•		
WDK 4N PE	ZQV 4N	•	•	•		

ZQV 2.5N

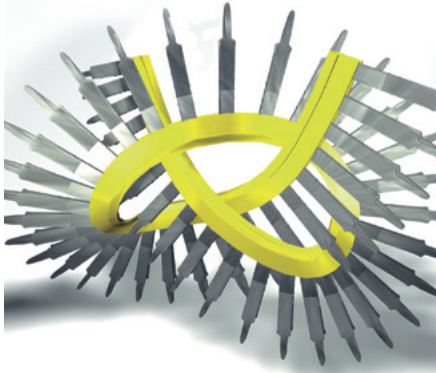

Continuous cross-connection

ZQV 2.5N/20 (20-pole) and ZQV 4N/20 (20-pole) are ideal for shortening (e.g. with tool KT ZQV - 9002170000) to produce customised configurations with the required number of poles.

More than 20 poles in a row are not recommended because of the resulting tolerances in the terminals.

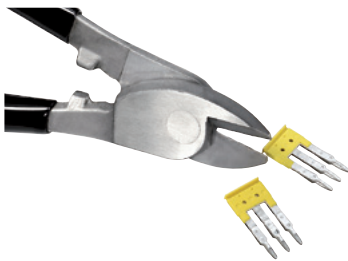

Special features of

WDU 2.5, WDU 4 und WDU 2.5/1.5/ZR

- Parallel distribution of 3 potentials
Important! Rated voltage reduced to 125 V!
- Parallel distribution of 2 potentials
Important! Only when using the outer cross-connection holes at 400 V
- The middle cross-connection hole can be used for either ZQV or WQV

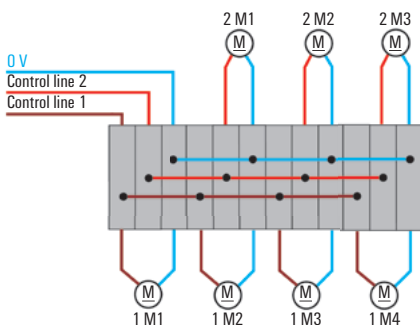

Important! For shortened ZQV located adjacent to each other (with bare cut edges), end plates or partition plates are necessary for rated voltage of 250 V.

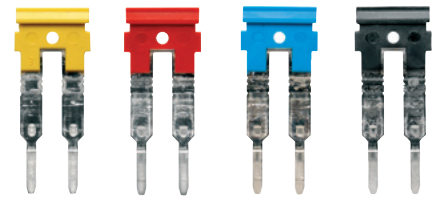

No. of poles
2
3
4
5
6
7
8
9
10
20

Type	I [A]	Qty.	Order No. yellow	Order No. red	Order No. blue	Order No. black
ZQV 2.5N/2	24	60	1693800000	1717900000	1717990000	1718080000
ZQV 2.5N/3	24	60	1693810000	1717910000	1718000000	1718090000
ZQV 2.5N/4	24	60	1693820000	1717920000	1718010000	1718100000
ZQV 2.5N/5	24	20	1693830000	1717930000	1718020000	1718110000
ZQV 2.5N/6	24	20	1693840000	1717940000	1718030000	1718120000
ZQV 2.5N/7	24	20	1693850000	1717950000	1718040000	1718130000
ZQV 2.5N/8	24	20	1693860000	1717960000	1718050000	1718140000
ZQV 2.5N/9	24	20	1693870000	1717970000	1718060000	1718150000
ZQV 2.5N/10	24	20	1693880000	1717980000	1718070000	1718160000
ZQV 2.5N/20	24	20	1909000000	1909110000	1909140000	1909130000

For terminal	
standard	compact
WDU 2.5/1.5 ZR	WDU 2.5N
WDU 2.5	WDK 2.5N
WDK 2.5/ ZQV	WDK 2.5N V
WDU 1.5 BLZ 5.08/ ZQV	WDK 2.5N DU-PE
	WMF 2.5...

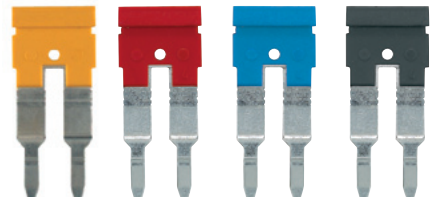

No. of poles
2
3
4
5
6
7
8
9
10
20

Type	I [A]	Qty.	Order No. yellow	Order No. red	Order No. blue	Order No. black
ZQV 4N/2	32	60	1758250000	1793950000	1793960000	1793970000
ZQV 4N/3	32	60	1762630000	1793980000	1793990000	1794000000
ZQV 4N/4	32	60	1762620000	1794010000	1794020000	1794030000
ZQV 4N/10	32	20	1758260000	1794040000	1794050000	1794060000
ZQV 4N/20	32	20	1909020000	1909150000	1909100000	1909120000

For terminal	
standard	compact
WDU 4	WDU 4N
WTR 4	WDK 4N
WTR 4 SI	WDK 4N V
WTR 4 SL	WDK 4N DU-PE
WTR 4/ZZ+ZR	WDK 2.5N V
WDU/PE4/ZZ+ZR	WDK 2.5N DU-PE

WQV screw-in cross-connection

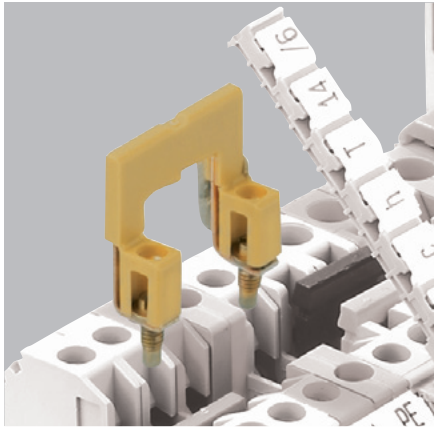

Any number of poles (extending)

Pre-fitted cross-connections can be set one after the other to produce any required number of poles.

To do so, arrange the last and first contact points of two identical WQVs so that they overlap.

- First, remove the fixing screw and screwdriver guide (insulated part) at one of the outer contact points of one of the WQVs.

WQV in combination with a socket contact and test plug

- Remove the fixing screw and insulation part of the WQV. Screw the socket in at this point. This now makes it possible to integrate a safe test point.

Thanks to the many possible ways in which the WQV cross-connection system can be used – break-out of individual layers, creation of any number of poles or running of two voltages parallel to one another – individual modules can be realised very easily!

Technical instructions

- The full rated current of the terminals can be routed across any number of poles.
- No end plates or partition plates needed for adjacent WQV up to 400 V.

Assembly

- Place the WQV in the cross-connection channel in the middle of the terminal and screw tight.
- Individual WQV segments can be broken out by bending over or using the WAW1 tool (9004500000). It is then possible to bridge individual or several terminals.

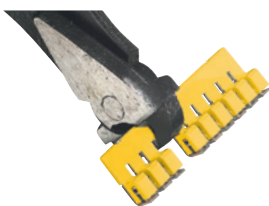

- Captive fixing screws.
- Snap onto the clamped support – simple overhead assembly.



- Then insert the WQV without fixing screw and insulated part. At the same time, insert an unmodified WQV in parallel so as to produce an overlap at the connection. The connection is screwed tight using the fixing screw of the unmodified WQV.

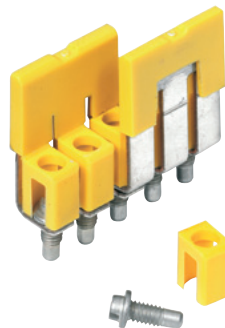

Routing 2 potentials in parallel

- In spite of only having 1 channel, the QV cross-connection system can still be used for offset cross-connections. See the photo “parallel bridging” (page D.167).

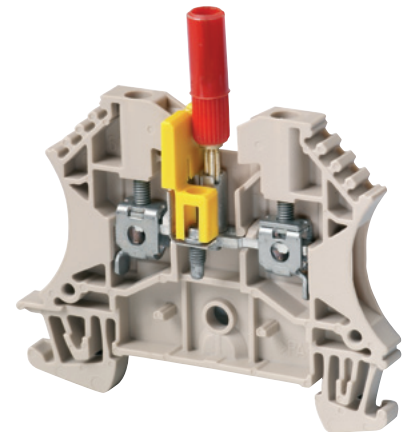

Potential distribution – possible combinations

In one cross-connection channel

single

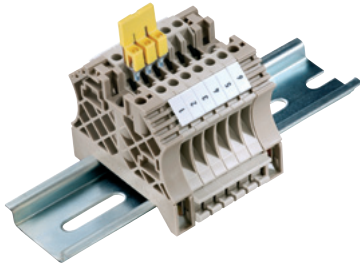

adjacent

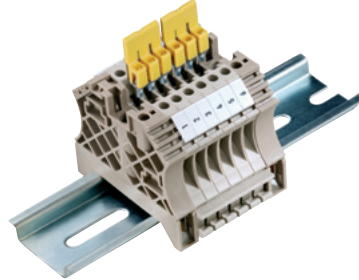

bridging

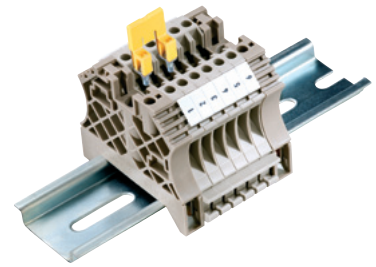

parallel/bridging

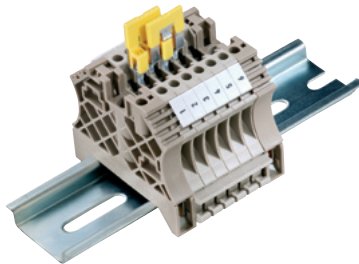

parallel/lengthening

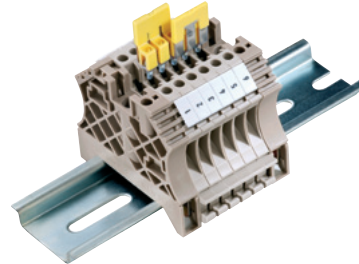

Possible cross-connections of terminals of the same type with appropriate cross-connectors

Terminal type	Cross-connector	single	adjacent	bridging	parallel bridging	parallel lengthening
Standard						
WDU 1.5/ZZ	WQV 2.5	•	•	•	•	•
WDU 1.5/BLZ	WQV 2.5	•	•	•	•	•
WDU 2.5/1.5/ZR	WQV 2.5	•	•	•	•	•
WDU 2.5 - WDU 35	WQV 2.5 - WQV 35	•	•	•	•	•
WDK 2.5...	WQV 2.5	•	•	•	•	•
WDK 2.5 PE	WQV 2.5	•	•	•	•	•
WDU 2.5/BLZ	WQV 2.5	•	•	•	•	•
WDK 2.5/BLZ	WQV 2.5	•	•	•	•	•
WDU 2.5 F...	WQV 2.5	•	•	•	•	•
WDK 2.5 F...	WQV 2.5	•	•	•	•	•
WDU 4... - WDU 35...	WQV 4 - WQV 35	•	•	•	•	•
WDU 70/95	WQV 70/95	•	•	•	•	•
WDU 120/150	WQV 120/150	•	•	•	•	•
WDU 240	WQB 240	•	•	•	•	•
Compact						
WDU 2.5N	WQV 2.5	•	•	•	•	•
WDU 2.5N 600V	WQV 2.5	•	•	•	•	•
WDU 16N	WQV 16N	•	•	•	•	•
WDU 35N	WQV 35N	•	•	•	•	•
WDU 50N	WQV 50N	•	•	•	•	•
WDU 70N	WQV 70N	•	•	•	•	•
WDU 95N/120N	WQV 95N/120N	•	•	•	•	•

WQV 2.5



Technical data	
Current	A
Type of fixing	Screwed
Pitch	mm
Ordering data	
2-pole	
3-pole	
4-pole	
5-pole	
6-pole	
7-pole	
8-pole	
9-pole	
10-pole	
15-pole	
20-pole	
32-pole	

32 / 32		
Screwed		
5,10		
Type	Qty.	Order No.
WQV 2.5/2	50	1053660000
WQV 2.5/3	50	1053760000
WQV 2.5/4	50	1053860000
WQV 2.5/5	10	1053960000
WQV 2.5/6	10	1054060000
WQV 2.5/7	10	1054160000
WQV 2.5/8	10	1054260000
WQV 2.5/9	10	1054360000
WQV 2.5/10	20	1054460000
WQV 2.5/15	10	1059660000
WQV 2.5/20	10	1577570000
WQV 2.5/32	10	1577600000

For terminal:

WDU 1.5 ZZ	WDK 2.5
WDU 1.5 BLZ	WDK 2.5 V
WDU 2.5/1.5 ZR	WDK 2.5 DU-PE
WDU 2.5	WDK 2.5 F
WDU 2.5 F	

WQV 4



/ 32		
Screwed		
6,10		
Type	Qty.	Order No.
WQV 4/2	50	1051960000
WQV 4/3	50	1054560000
WQV 4/4	50	1054660000
WQV 4/5	10	1057860000
WQV 4/6	10	1057160000
WQV 4/7	10	1057260000
WQV 4/10	20	1052060000

For terminal:

WDU 4
WDU 4 SL

WQV 6



/ 57		
Screwed		
8,00		
Type	Qty.	Order No.
WQV 6/2	50	1052360000
WQV 6/3	50	1054760000
WQV 6/4	50	1054860000
WQV 6/5	50	1062660000
WQV 6/6	50	1062670000
WQV 6/7	50	1062680000
WQV 6/10	20	1052260000

For terminal:

WDU 6
WDU 6 SL

WQV 35N



Technical data	
Current	A
Type of fixing	Screwed
Pitch	mm
Ordering data	
2-pole	
3-pole	
4-pole	
5-pole	
6-pole	
7-pole	
8-pole	
9-pole	
10-pole	
15-pole	
20-pole	
32-pole	

/ 101		
Screwed		
16,00		
Type	Qty.	Order No.
WQV 35N/2	20	1079200000
WQV 35N/3	20	1079300000
WQV 35N/4	20	1079400000

For terminal:

WDU 35N

WQV 50N



/ 150		
Screwed		
18,50		
Type	Qty.	Order No.
WQV 50N/2	5	1834060000
WQV 50N/3	5	1834070000
WQV 50N/4	5	1834080000

For terminal:

WDU 50N

WQV 70N

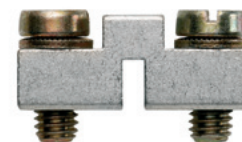

/ 192		
Screwed		
20,50		
Type	Qty.	Order No.
WQV 70N/2	5	9512240000
WQV 70N/3	5	9512250000
WQV 70N/4	5	9531290000

For terminal:

WDU 70N

WQV 10



/ 57		
Screwed		
10,00		
Type	Qty.	Order No.
WQV 10/2	50	1052560000
WQV 10/3	50	1054960000
WQV 10/4	50	1055060000
WQV 10/10	20	1052460000

For terminal:
 WDU 10
 WDU 10 SL
 WDU 10 ZR

WQV 16



101 / 76		
Screwed		
12,00		
Type	Qty.	Order No.
WQV 16/2	50	1053260000
WQV 16/3	50	1055160000
WQV 16/4	50	1055260000
WQV 16/10	10	1053360000

For terminal:
 WDU 16

WQV 16N

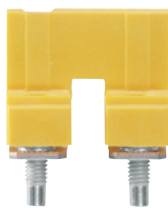

101 / 76		
Screwed		
12,00		
Type	Qty.	Order No.
WQV 16N/2	50	1636560000
WQV 16N/3	50	1636570000
WQV 16N/4	50	1636580000

For terminal:
 WDU 16N

WQV 35



/ 112		
Screwed		
16,00		
Type	Qty.	Order No.
WQV 35/2	50	1053060000
WQV 35/3	50	1055360000
WQV 35/4	50	1055460000
WQV 35/10	10	1053160000

For terminal:
 WDU 35

WQV 70/95



/ 192		
Screwed		
27,00		
Type	Qty.	Order No.
WQV 70/95/2	5	1063500000
WQV 70/95/3	5	1063600000

For terminal:
 WDU 70/95

WQV 95N/120N

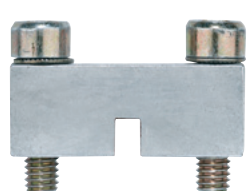

269 / 269		
Screwed		
27,00		
Type	Qty.	Order No.
WQV 95N/120N-2	5	1826890000
WQV 95N/120N-3	5	1826900000
WQV 95N/120N-4	5	1826910000

For terminal:
 WDU 95N/120N

WQV 120

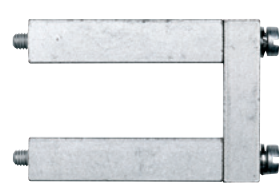

/ 269		
Screwed		
32,00		
Type	Qty.	Order No.
WQV 120/2	5	1063300000
WQV 120/3	5	1063400000

For terminal:
 WDU 120/150

Screwable QV

Q AKZ 4 SS



Technical data	
Current	A
Type of fixing	Screwed
Pitch	mm
Ordering data	
2-pole	
3-pole	
4-pole	
5-pole	
10-pole	
20-pole	

20 / 20		
Screwed		
5,10		
Type	Qty.	Order No.
Q 2 AKZ4SS	50	0369000000
Q 10 AKZ4SS	20	0369300000
For terminal:		
WDK 2.5 / 800 V		

Q / DLI

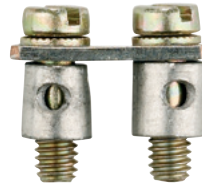

20 / 20		
Screwed		
5,00		
Type	Qty.	Order No.
Q 2 DLI	50	1312500000
Q 3 DLI	50	1312600000
Q 4 DLI	50	1312700000
Q 10 DLI	20	1313100000
Q 20 DLI	20	1399800000
For terminal:		
DLI 2.5 DLA 2.5 DLD 2.5		

Q AKZ 1.5



/ 24		
Screwed		
5,10		
Type	Qty.	Order No.
Q 2 AKZ1.5	50	0368200000
Q 3 AKZ1.5	50	0368300000
Q 4 AKZ1.5	50	0368400000
Q 10 AKZ1.5	20	0368500000
For terminal:		
AKZ 1.5 AKZ 2.5		

Screwable QV

Q AKZ 4



Technical data	
Current	A
Type of fixing	Screwed
Pitch	mm
Ordering data	
2-pole	
3-pole	
4-pole	
5-pole	
10-pole	
20-pole	

32 / 32		
Screwed		
6,10		
Type	Qty.	Order No.
Q 2 AKZ4	50	0336400000
Q 3 AKZ4	50	0336500000
Q 4 AKZ4	50	0336600000
Q 10 AKZ4	20	0368600000
For terminal:		
AKZ 4		

Q / WDL



/ 24		
Screwed		
6,10		
Type	Qty.	Order No.
Q 2 WDL2.5S	50	1071500000
Q 3 WDL2.5S	50	1071600000
Q 4 WDL2.5S	50	1071700000
Q 10 WDL2.5S	20	1071800000
Q 20 WDL2.5S	20	1074200000
For terminal:		
WDL 2.5/S...(with 10 x 3 busbar) WDL 2.5 (With isolator, external side)		

External cross-connection bridges

Function

External cross-connection bridges make it possible to switch terminals in parallel, which are not available in the middle of the terminal via a cross-connection channel.

Assembly

These bridges are positioned over the conductor in the clamping point and connected. Individual contacts can be separated off by hand when you wish to skip a clamping point.

Important! Use of these parts reduces the nominal cross-section of the connected conductor to the next smallest size for the terminal in question.

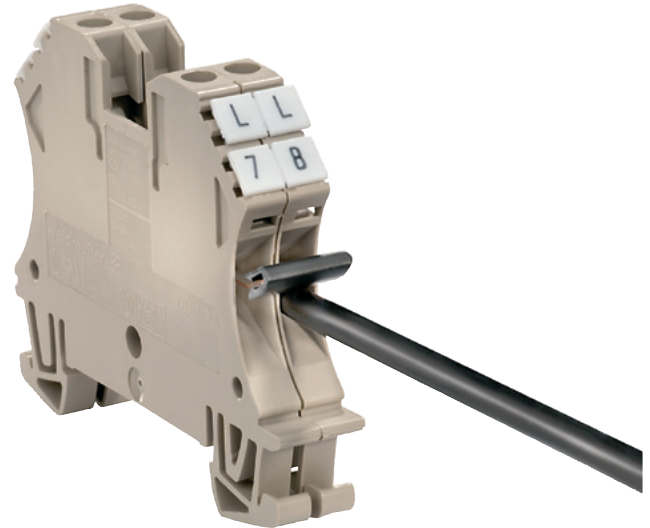

QL ... WSI 6

Pitch 6,3 mm

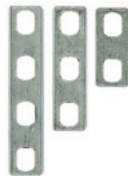

WQB A / ...

Pitch 5,1 mm



WQB B / ...

Pitch 5,1 mm



Technical data

Continuous current 2-pole/multi-pole	A
Fork length	mm

24 / 24
12

24 / 24
12

24 / 24
16

Ordering data

2-pole	QL 2	100	0194300000
3-pole	QL 3	100	0194400000
4-pole	QL 4	50	0194500000
10-pole	QL 10	20	0338300000
24-pole			
Fixing screw	BS-M 3 x 5	100	1052100000
Releasing tool	WAW 2	1	9004510000

Type	Qty.	Order No.
QL 2	100	0194300000
QL 3	100	0194400000
QL 4	50	0194500000
QL 10	20	0338300000
BS-M 3 x 5	100	1052100000
WAW 2	1	9004510000

For terminal:
WSI 6...

Type	Qty.	Order No.
WQB A / 2	50	1578950000
WQB A / 3	50	1578960000
WQB A / 4	50	1578970000
WQB A / 10	50	1578990000
WQB A / 24	50	1579000000

For terminal:
WDK 2.5

Type	Qty.	Order No.
WQB B / 2	50	1579010000
WQB B / 3	50	1579020000
WQB B / 4	50	1579030000
WQB B / 10	50	1579050000
WQB B / 24	50	1579060000

For terminal:
WDU 1,5 / ZZ (lower connection level)
WDU 2.5
WDU 2,5 / 1,5 / ZR (lower connection level)
WTR 2.5

Testing in terminals

PS

Test plug



Test plugs (PS) are used for measurements or final testing of ready wired terminal strips. Test plugs are available for socket contacts with an internal diameter of 2.3 mm or 4 mm. The difference to the test adapter is that the test plug does not slot into the terminal. This means that reliable plugging into feed-through terminals up to 35 mm² is only possible with a socket.

Special feature for large cross-sections

WDU 70N, WDU 95N/120N, WDU 70/95, WDU 120/150

In these terminals, test plug PS 4 can be plugged into the head of the clamping screw for measurements.

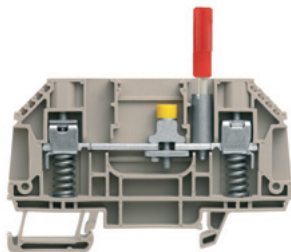

Ordering data

Test plug	Qty.	Order No.
2.3 mm diameter / rated current 17.5 A		
PS 2.3	20	0180400000
4.0 mm diameter / rated current 24 A		
PS 4	20	0299600000

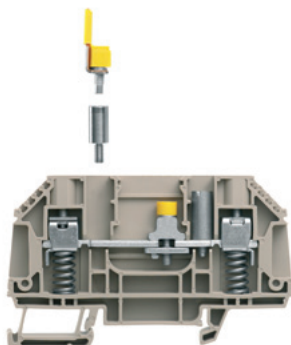

StB

Socket



The StB socket is used for fitting the PS test plug. The sockets are screwed into the busbar in the cross-connection channel in the middle of the terminal. The WTR test-disconnect terminals are available with pre-assembled sockets (refer to the W-Series test-disconnect terminals). The sockets are equipped with a slot for the screwdriver. A special screwdriver blade guarantees that the sockets are securely tightened (see catalogue Tools, chapter F).

Combining with WQV

The socket can be used in combination with the WQV screw-in crossconnection.

For this purpose, the insulating part of the screw and the fixing screw have to be removed at the corresponding pole in the WQV. The socket can then be screwed in.

Ordering data

Socket	For test plug	Qty.	Order No.	For terminal standard design	For terminal compact design
Thread M 2.5 / Length 11.5 mm					
StB 8.5	PS 2.3	50	0215700000	WDU 1.5/ZZ WDU 2.5/1.5/ZR WDU 2.5 WDK 2.5...	WDU 2.5N (WQV) WDU 2.5N 600V UL
Thread M 3 / Length 12 mm					
StB 8.5	PS 2.3	50	0280600000	WDU 4 WDU 6 WDU 10 WDU 10/ZR	
Thread M 3 / Length 19 mm					
StB 14	PS 4	50	0169900000	WDU 10 WDU 10ZR	WDU 16N WDU 35
Thread M 4 / Length 23 mm					
StB 16	PS 4	50	0140200000	WDU 16	WDU 35N WDU 35
Thread M 3 / Length 23 mm (finger-safe)					
StB 21.6	PS 4	50	1071000000	WDU 4 WDU 10	WDU 6

Test adapter

WTA 1



Dimensions	
Width / Length / Height	mm
Stripping length	mm
Rated data	
Rated voltage	V
Rated current	A
Rated cross-section	mm ²
Clamped conductors (H05V/H07V)	
solid / stranded	mm ²
flexible / flexible with ferrule	mm ²
Ordering data	
1-pole	
With snap-in pegs	
10-pole	

5 / 66.1 / 98.2			
6			
IEC	UL	CSA	
250	300	300	
6	6	6	
1.5			
0.5...1.5			
1...1.5 / 0.5...1.5			
Type	Qty.	Order No.	
WTA 1 WDU1.5	25	1632290000	
WTA 1/ZA WDU1.5	25	1632300000	
For terminal:			
WDU 2.5N			
WDU 4N			

WTA 2



5 / 66.1 / 107.6			
6			
IEC	UL	CSA	
250	300		
6			
1.5			
0.5...1.5			
1...1.5 / 0.5...1.5			
Type	Qty.	Order No.	
WTA 2 WDU2.5-10	25	1632320000	
WTA 2/ZA WDU2.5-10	25	1632330000	
WTA 2/10 WDU2.5/10	5	1632340000	
For terminal:			
WDU 1.5 ZZ		WDU 4	
WDU 2.5/1.5 ZR		WDU 6	
WDU 2.5		WDU 10	
WDU 2.5 F		WDU 16	

WTA 3



6 / 66.1 / 107.6			
6			
IEC	UL	CSA	
250	300		
6			
1.5			
0.5...1.5			
1...1.5 / 0.5...1.5			
Type	Qty.	Order No.	
WTA 3 WDU4	25	1632350000	
WTA 3/ZA WDU4	25	1632360000	
For terminal:			
WDU 4			
WDU 6			
WDU 10			

Test adapter

WTA 6



Dimensions	
Width / Length / Height	mm
Stripping length	mm
Rated data	
Rated voltage	V
Rated current	A
Rated cross-section	mm ²
Clamped conductors (H05V/H07V)	
solid / stranded	mm ²
flexible / flexible with ferrule	mm ²
Ordering data	
1-pole	
With snap-in pegs	
10-pole	

5 / 66.1 / 107.6			
6			
IEC	UL	CSA	
250	300	300	
6	6	6	
1.5			
0.5...1.5			
1...1.5 / 0.5...1.5			
Type	Qty.	Order No.	
WTA 6 WTR2.5	25	1632380000	
WTA 6/ZA WTR2.5	25	1632390000	
For terminal:			
WTR 2.5			

WTA 7



6 / 68 / 120			
6			
IEC	UL	CSA	
250	300		
6			
1.5			
0.5...1.5			
1...1.5 / 0.5...1.5			
Type	Qty.	Order No.	
WTA 7 WSI6	25	1650210000	
For terminal:			
WSI 6			

WTA 4N



5 / 62 / 111.6

IEC	UL	CSA
250	300	
6		
1.5		

0.5...1.5
1...1.5 / 0.5...1.5

Type	Qty.	Order No.
WTA 4N WDK 2.5	25	1878660000
WTA 4N/ZA WDK 2.5	25	1879350000

For terminal:

WDK 2.5
WDK 2.5 V
WDK 2.5 F
WDK 2.5 FV

WTA 5



5 / 17 / 68.2

IEC	UL	CSA
250	300	
6		
1.5		

0.5...1
1...1 / 0.5...1

Type	Qty.	Order No.
WTA 5/1	25	1051260000

For terminal:

WDU 2.5 WDU 10
WDU 4 WDU 10 ZR
WDU 6

Test adapter

Dimensions	
Width / Length / Height	mm
Stripping length	mm
Rated data	
Rated voltage	V
Rated current	A
Rated cross-section	mm ²
Clamped conductors (H05V/H07V)	
solid / stranded	mm ²
flexible / flexible with ferrule	mm ²
Ordering data	
	green
	beige

WTA 8



6 / 39 / 78

IEC	UL	CSA
205		
6		
1.5		

0.5...2.5

Type	Qty.	Order No.
WTA 8KO-TN	25	1915480000
WTA 8 TN	25	1915450000

For terminal:

WTL 4/2 StB

TN-KO = Isolate - Contact
KO-TN = Contact - Isolate
TN = Isolate

Labelling / cover

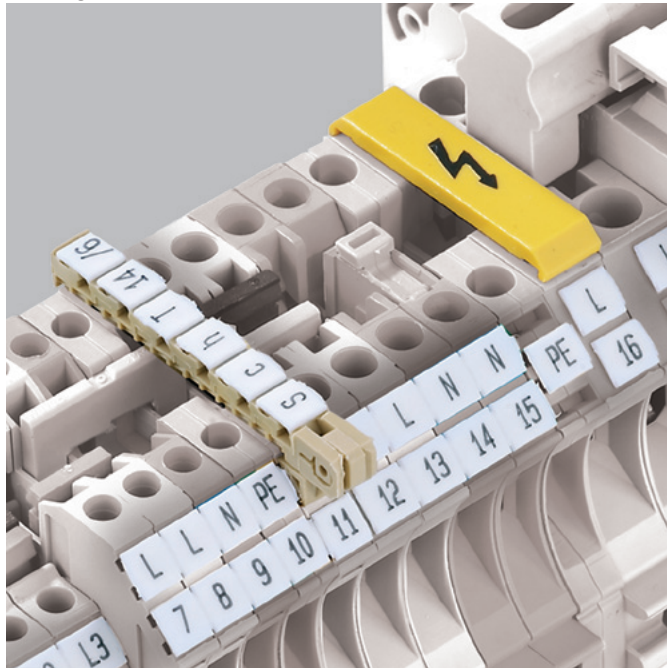

The WAD cover is snapped on to the centre of the terminal on the cross-connection channel, from the top down. The covers are delivered in yellow with a black lightning flash symbol and also in white without markings. The WAD covers are available for all feed-through terminals in the W-Series.

Labelling of mains terminals

VDE regulations require that mains terminals be labelled with "Warning Voltage" and a lightning flash symbol.

Convenient labelling options

A white cover with no print is well suited for manual terminal labelling or for group labelling.

Touch protection with uninsulated cross-connections

Important! When cross-connecting the WDU 70N, WDU 95N/120N, WDU 70/95 and WDU 120/150, touch protection is guaranteed by the cover, in compliance with VDE directives.

WAD

Type	Colour	Qty.	Order No.	For terminal:
WAD 4 GE BED	yellow	50	1072000000	WDK 2.5
WAD 4 WS	white	50	1072100000	WDK 2.5 / 800V WDK 2.5 BL WDK 2.5 DU-PE WDK 2.5 F WDK 2.5 F BL WDK 2.5 FF WDK 2.5 FV WDK 2.5 ZQV WDK 2.5 ZQV BL WDK 2.5/D WDK 2.5V WDK 2.5V BL WDU 1.5/ZZ WDU 1.5/ZZ BL WDU 2.5 F 2X2.8 WDU 2.5 FF 2*2.8 WDU 2.5N WDU 2.5N BL WDU 2.5N ZQV WDU 2.5N ZQV BL WDU 2.5N/600 UL WDU 4N WDU 4N BL
Width				
WAD 5 MC NE WS	white	48	1112910000	WDU 2.5
WAD 5 MC B GE/SW	with lightning flash black on yellow	49	1120450000	WDU 2.5 BL WDU 2.5/1.5/ZR WDU 2.5/1.5/ZR BL WDU 4 WDU 4 BL WDU 6 WDU 6 BL
Width				
WAD 8 MC B GE/SW	Lightning flash black on yellow	48	1120470000	WDU 10
WAD 8 MC NE WS	white	48	1112940000	WDU 10 BL
Width				
WAD 12 M. BL.	yellow	50	1055960000	WDU 16/Z A
WAD 12 NEUTRAL	white	50	1056260000	WDU 16/Z A BL WDU 16N BL WDU 35/IK/Z A WDU 35/Z A WDU 35/Z A BL
Width				
WAD 12N GE BED	yellow	50	1073200000	WDU 16N
Width				
WAD 16N GE BED	yellow	50	1083600000	WDU 16N
WAD 16N WS	white	50	1083500000	WDU 35N WDU 35N BL
Width				
WAD 20 GE WSD	yellow	10	9512260000	WDU 50N WDU 50N BL WDU 70N/35 WDU 70N/35 BL WDU 95N WDU 95N BL
Width				
WAD 27 M. BL.	yellow	10	1062860000	WDU 120
WAD 27 NEUTRAL	white	10	1062960000	WDU 120 BL WDU 70/95 WDU 70/95 BL

SIHA fuse holder

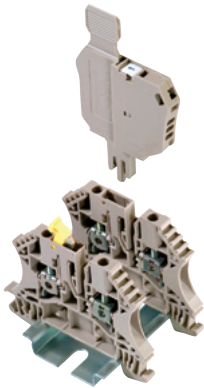

For 5x20 G-fuse cartridges

The SIHA fuse holder turns a test disconnect terminal into a fuse terminal in seconds: Simply remove the isolating lever and insert the fuse plug

- Simple handling – no tools required
- Housing made of Wemid (VO)
- Rated current 6.3 A
- 1.6 W power loss to DIN VDE 0611-6 at 23 °C ambient temperature (also for 1.5 times rated current – composite arrangement)
- Even fits on 5 mm wide terminals when fitted in offset arrangement
- Marking position for Dekafix 5 and space for self-adhesive label size 8/20

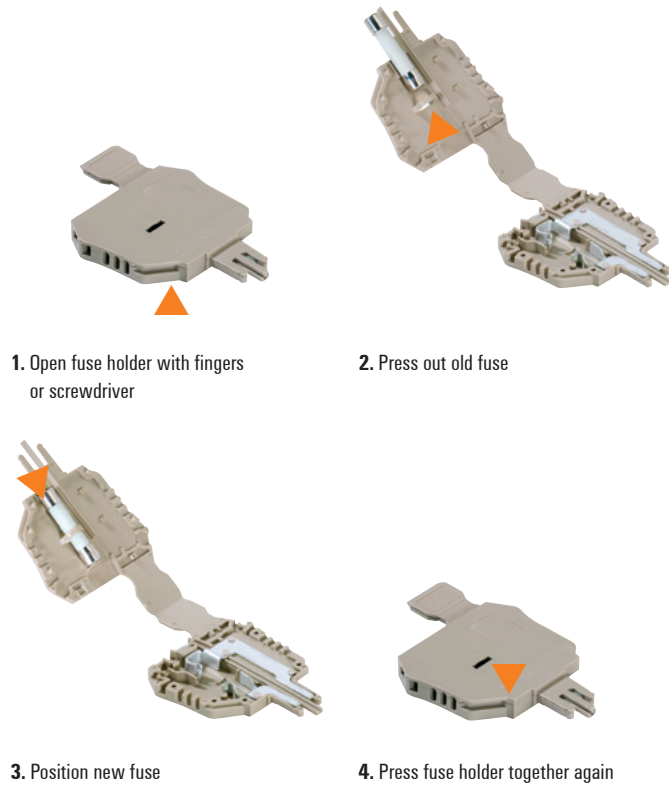

1. Open fuse holder with fingers or screwdriver

2. Press out old fuse

3. Position new fuse

4. Press fuse holder together again

SIHA 1



	Qty.	Order No.
without LED		
SIHA1/G20	400 V 1	9537550000
with LED (red)		
SIHA1/G20	10 - 36 V 1	9537560000

For test-disconnect terminal versions
WTR 2.5/ZZ

SIHA 3



	Qty.	Order No.
without LED		
SIHA3/G20	400 V 1	7921560000
with LED (red)		
SIHA3/G20	10 - 36 V 1	7921570000
	35 - 70 V 1	7921580000
	60 - 150 V 1	7921590000
	140 - 250 V 1	7921600000

For test-disconnect terminal versions
WTR 4
WTR 4/ZZ
WTR 4/ZR
WTR 2.5

SIHA STRAP

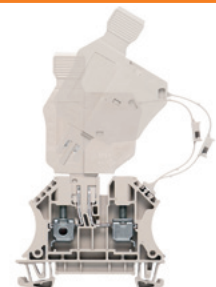

	Qty.	Order No.
with strap		
SIHA STRAP	20	9537680000

Connector for "retro-fit" assembly

- Receptacle in the terminal is the marking position
- Integrated marking position on the strap
- Slots into fuse holder either left or right

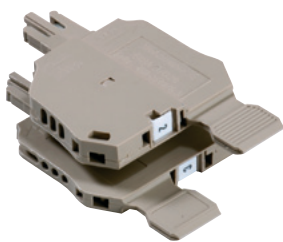

Fuse carrier ZST 1



The ZST 1 fuse-carrier can hold 6 device fuses (5 x 20 or 5 x 25 mm) which are available to be used during servicing work.

ZST 1



Dimensions

Width / Length / Height	mm	8 / 62 / 40
-------------------------	----	-------------

Ordering data

Type	Qty.	Order No.
ZST 1	25	1269070000

Component isolating plugs

The Weidmüller philosophy is to realise a multitude of applications using as few parts as possible. The component and isolating plugs (BEST and TNST) represent a logical extension of this cost-effective and efficient approach. The component plug can accommodate electronic components and connect them to the terminal. And once an isolating plug is removed, the clamping point is obviously disconnected. The opening is easy to recognise.

An unintentional reconnection of the circuit is prevented by simply removing the isolating plug. The BEST and the TNST have the same pin arrangement. Both plugs are also identical with the SIHA 3 fuse holder, meaning that they can be used in all the "disconnecting products" of the W-, Z-, I- and P-Series.

Component plug (up to 250 V)

can be reversed

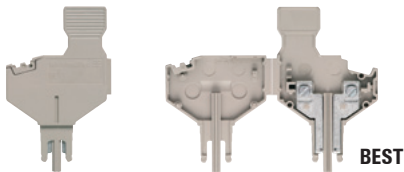

Ordering data

Type	Fitted with...	Qty.	Order No.
BEST	-	25	1833100000
BEST/DRBR	wire jumper	25	1878570000
BEST/D	diode 1N4007	25	1878560000

For terminal type

PTR 2.5/4...

PDL 4 TR/...

Isolating plug

Isolating plug



Ordering data

Type	Colour	Qty.	Order No.
TNST	yellow Wemid	25	1833090000

For terminal type

WTR 2.5

WTR 4

WTR4/ZZ

WTR4/ZR

Screen plug (LS)

A screen plug (LS) is available for many terminals in the W-Series. The bar can be used to continue the shielding over the terminals as an interface. There is no direct connection to earth potential.

Assembly

The screen plug is placed flat in the bottom of the terminal in the recess provided. At the ends, the shield can be plugged in with a 2.8 mm Faston connector or soldered on.

Reduced rated voltage

The smaller clearance and creepage sections result in a reduced voltage rating in the terminal when using the screen plug.

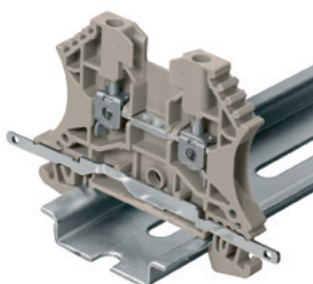

LS 2.8

Type	Qty.	Order No.
LS 2.8 WDU2.5-10	50	1056400000

Reduced voltage

For terminal standard design	Reduced voltage
WDU 1.5/ZZ	400 V
WDU 2.5/1.5/ZR	400 V
WDU 2.5	400 V
WDU 4	400 V
WDU 6	400 V
WDU 10	400 V
WDK 2.5 ZQV	250 V
WDK 2.5 (WQV)	250 V
WTR 2.5...	250 V
For terminal compact design	Reduced voltage
WDK 2.5N	250 V
WDK 4N	250 V

Short-circuit plug (WDS)

Short-circuit plugs (cross-connection plugs) are used together with sockets (diameter 2.3 mm) for easily disconnecting the cross connection of terminals.

In reality, this connector is often used with test-disconnect terminals. Thanks to its insulated grip, the WDS is touch-safe.

Assembly

The plug is simply plugged onto the socket and locks automatically.

For terminal width 5.1 mm

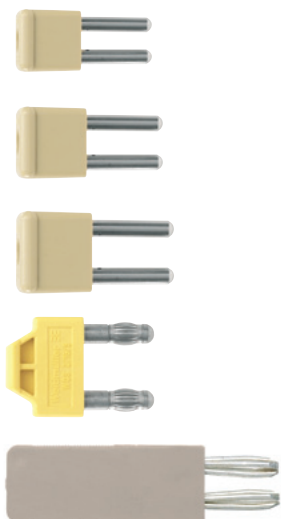

WDS

Type	Qty.	Order No.
WDS 2	20	1069900000

Reduced voltage

For terminal	Reduced voltage
WDU 1.5/ZZ	
WDU 2.5/1.5/ZR	
WDU 2.5	
WDK 2.5... (WQV)	
WTR 2.5...	
WDU 2.5 F...	

Extension connector (WZAD)



Assembly

This connector consists of a metal part which is pushed into the terminal and lodges behind the clamping yoke. The WZAD extension connector is connected to the "main" conductor in the terminal. Another conductor of up to 4 mm² and 32 A can be screwed to the outer end of the extension connector using a ring cable lug.

An extension connector (WZAD) is offered for feed-through terminals from 70 mm².

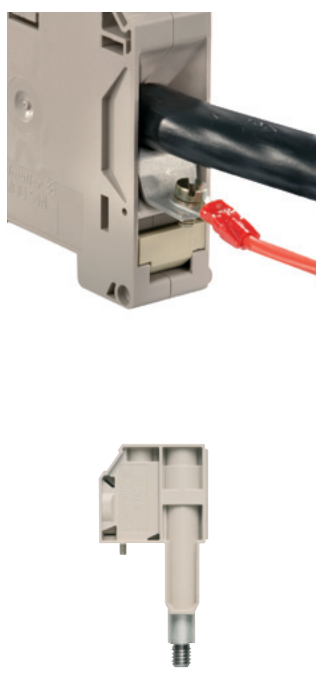

Exception WZAD WDU 240

The extension connector for WDU 240 is plugged separately into the terminal above the wire entry and locks automatically. The conductor is connected with a fully insulated screw connection.



WZAD

Type	Clamped conductor	Rated current	Qty.	Order No.	For terminal
WZAD 70/95	up to 4 mm ²	32 A	10	1066000000	WDU 70/95
WZAD 120	up to 4 mm ²	32 A	10	1066100000	WDU 120/150
WZAD 240	up to 10 mm ²	57 A	5	1802810000	WDU 240
WZAD 50N	up to 10 mm ²	40 A	5	1872720000	WDU 50N
WZAD 70N	up to 4 mm ²	32 A	10	1964830000	WDU 50N/70N
WZAD 95N/120N	up to 10 mm ²	41 A	5	1859580000	WDU 95N/120N

WZAF with M3 mounting screw

Type	Clamped conductor	Rated current	Qty.	Order No.	For terminal
WZAF 35	4 mm ²	32 A	10	1070500000	WFF 35
WZAF 70	4 mm ²	32 A	10	1066200000	WFF 70
WZAF 120	4 mm ²	32 A	10	1066300000	WFF 120
WZAF 185	4 mm ²	32 A	10	1066400000	WFF 185
WZAF 300	4 mm ²	32 A	10	1066500000	WFF 300

PEN bridges

Energy distribution for machines or in buildings usually consists of 5-conductor systems (TN-S). By contrast, energy supply mains are frequently rated as 4-conductor connection. A PEN bridge joins separate PE and N conductors into one PEN conductor, creating the transition from a TN-S to a TN-C system.

Standard installation

Depending on the terminal type, inside or outside, PEN bridges are available for both PE and N conductor terminals from 10 mm². **Important!** For outside bridges, please note that in this context only the next smaller rated cross-section (than standard) can be connected.

Building installation with N-conductor isolation

Special external cross-connections (WQB-PEN) are available for neutral conductor test-disconnect terminals (WNT). These establish contact between the NT and PE terminals. This results in an earthed neutral conductor with protection function in three-phase systems.

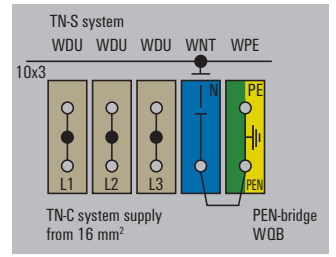

External PEN bridge



Inside PEN bridge

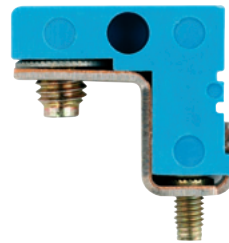

WQB-PEN ...

Type	Qty.	Order No.	For terminal
with standard terminals			
WQB-PEN 10	10	1060300000	WPE 10 WDU 10 BL
WQB-PEN 16	10	1060200000	WPE 16 WDU 16 BL
WQB-PEN 35	10	1060100000	WPE 35 WDU 35 BL
with compact terminals			
WQB-PEN 16N	10	1079600000	WNT 16N WPE 16N
WQB-PEN 35N	10	1079500000	WNT 35N WPE 35N
WQB-PEN 70N	10	1079700000	WNT 70N WPE 70N

WQV ... -PEN

Type	Qty.	Order No.	For terminal
WQV 16N-PEN	10	1071360000	WPE 16N WDU 16N BL
WQV 70N-PEN	5	9525840000	WPE 70N WDU 70N BL
WQV 70/95-PEN	5	1072300000	WPE 70/95 WDU 70/95 BL
WQV 120-PEN	5	1072400000	WPE 120/150 WDU 120/150 BL
WQV 50N-PEN		9201610000	WPE 50N WDU 50N
WQV 95N/120N-PEN		9201630000	WPE 95N/120N WDU 95N/120N

TN-S system:

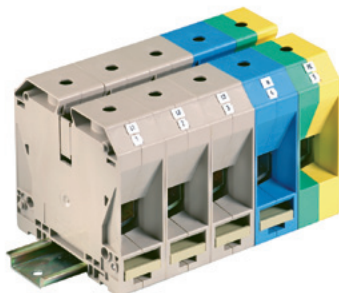
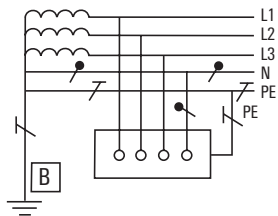

TN-C system:

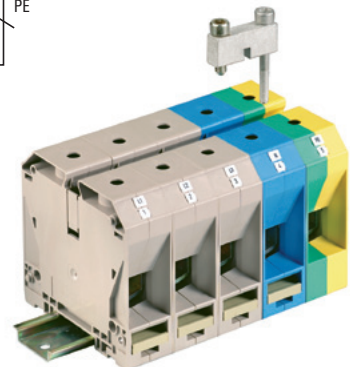
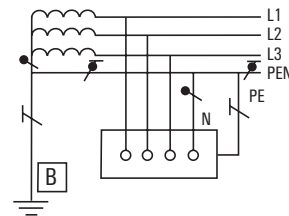

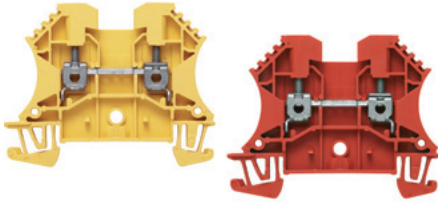

The colours listed are available as standard. Other terminal types can be supplied in customised colours on request for quantities exceeding the minimum quantity.

Standard design

WDU 2.5	Colour	Qty.	Order No.
WDU 2.5 BL	blue	100	1020080000
WDU 2.5 OR	orange	100	1020060000
WDU 2.5 BR	brown	100	1037710000
WDU 2.5 GE	yellow	100	1020020000
WDU 2.5 GN	green	100	1020090000
WDU 2.5 GR	grey	100	1037720000
WDU 2.5 RT	red	100	1020040000
WDU 2.5 SW	black	100	1020010000
WDU 2.5 VI	violet	100	1037700000
WDU 2.5 WS	white	100	1036800000
WDK 2.5			
WDK 2.5 OR	orange	100	1021560000
WDK 2.5 V			
WDK 2.5 V OR	orange	100	1022360000
WDK 2.5 V GE	yellow	100	1022350000
WDU 4			
WDU 4 BL	blue	100	1020180000
WDU 4 OR	orange	100	1036760000
WDU 4 BR	brown	100	1037810000
WDU 4 GE	yellow	100	1020120000
WDU 4 GE/SW	yellow/black	100	1020190000
WDU 4 GN	green	100	1020160000
WDU 4 GR	grey	100	1037800000
WDU 4 RT	red	100	1020140000
WDU 4 SW	black	100	1020110000
WDU 4 VI	violet	100	1037820000
WDU 4 WS	white	100	1036700000
WDU 6			
WDU 6 BL	blue	100	1020280000
WDU 6 OR	orange	100	1020260000
WDU 6 GE	yellow	100	1040220000
WDU 6 GN	green	100	1020290000
WDU 6 GR	grey	100	1039600000
WDU 6 RT	red	100	1020240000
WDU 6 SW	black	100	1020210000
WDU 6 WS	white	100	1039700000
WDU 10			
WDU 10 BL	blue	50	1020380000
WDU 10 GE	yellow	50	1833350000
WDU 10 GN	green	50	1833340000
WDU 10 OR	orange	50	1020360000
WDU 10 RT	red	50	1020340000
WDU 10 SW	black	50	1020310000
WDU 10 WS	white	50	1833380000
WDU 16			
WDU 16 BL	blue	50	1020480000
WDU 16 RT	red	50	1833400000
WDU 16 SW	black	50	1833420000
WDU 35			
WDU 35 BL	blue	40	1020580000
WDU 35/IK BL	blue	40	1020680000
WDU 35/ZA BL	blue	40	1028880000
WDU 35/ZA OR	orange	40	1060220000
WSI 6			
WSI 6 OR	orange	50	1011060000
WSI 6 SW	black	50	1011010000
WSI 6 BL	blue	50	1011080000
WTD 6/1			
WTD 6/1 GE	yellow	50	1631760000
WTD 6/1 RT	red	50	1631750000
WTL 6/3			
WTL 6/3 BR	brown	50	1018640000

Compact design

WDU 2.5	Colour	Qty.	Order No.
WDU 2.5 BL	blue	100	1023780000
WDU 2.5N OR	orange	100	1023760000
WDU 2.5N ZQV BL	blue	100	1040880000
WDK 4N			
WDK 4N BL	blue	100	1042680000
WDK 4N OR	orange	100	1041960000
WDU 16			
WDU 16N BL	blue	50	1036180000
WDU 35			
WDU 35N BL	blue	20	1040480000
WDU 35N KB BL	blue	20	1836550000

Pre-fitted terminal blocks

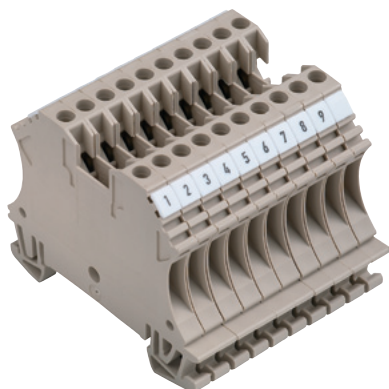

Readily assembled and marked terminal blocks are available as a standard feature for smaller cross-section ranges.

Installation times can be reduced by simply slotting in complete blocks. The rating data depends on the corresponding terminal type.

Important!

- Tolerances for mounting must be heeded in project planning. A mounting tolerance of +0.1 mm must be expected for each terminal.
- In terminal blocks marked 1- 9, the 10th terminal is free for decade marking
- Terminal blocks WDU 70/95 and WDU 120/150 for direct mounting only.
For direct mounting without the terminal rail please take note of the drilling plan. Fix with screw M6x16. (Order No. 1063700000/ VPE 20)

WDU 2.5	Qty.	Order No.	Description
WDU 2.5/10 BEZ	10	1020700000	10 x WDU 2.5, identified by printed marking strip DEK 5 (nos. 1 - 9)
WDU 2.5/10 BEZ/NE	10	1020800000	10 x WDU 2.5, with blank marking strip DEK 5
WDK 2.5			
WDK 2.5/10	10	1025700000	10 x WDK 2.5 (WQV), with blank marking strip DEK 5
WDU 4			
WDU 4/10/BEZ	10	1020900000	10 x WDK 2.5 (ZQV), identified by printed marking strip DEK (nos. 1-9)
WDU 4/10	10	1021000000	10 x WDU 4, identified by printed marking strip DEK 6
WMA 4/4	20	1034000000	3 x WDU 4 (marked L1, L2, L3), WPE 4 (marked PE)
WMA 4/5	20	1033800000	3 x WDU 4 (marked L1,L2,L3), DEU 4 in blue (identified by N), WPE 4 (marked PE)
WDU 70/95			
WDU 70/95/3	4	1026700000	3 x WDU 70/95
WDU 70/95/5/N	2	1032300000	mains terminal block, 3x WDU 70/95 dark beige, 1x WDU 70/95 blue, 1 x WDU 70/95 green
WDU 120/150			
WDU 120/150/5	2	1026600000	5 x WDU 120/150
WDU 120/150/5/N	2	1032400000	mains terminal block, 3 x WDU 120/150 dark beige, 1 x WDU 120/150 blue, 1 x WDU 120/150 green
WDL 2.5			
WDL 2.5/3/S/NT/L/PE	25	1034200000	3 x WDL 2.5/S/NT/L/PE
WDL 2.5/2/NT/L/PE-L/L	20	1034100000	WDL 2.5/S/NT/L/PE and WDL 2.5/S/L/L
AKZ 4			
AKZ 4/10	10	0359560000	10 x AKZ 4
AKZ 4/10/BEZ	10	0359660000	10 x AKZ 4, identified by printed marking strips DEK 5 (nos. 1-9)

SAK-Series / Clamping yoke screw connection technology

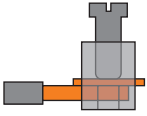

- Put to the test billions of times**
 Countless approvals, specifications and the world's most extensive range of terminals mean that SAK terminals can be used for a wide range of different applications.
- The right materials for every application**
 Ambient temperatures are not an issue for the SAK-Series thanks to different materials such as polyamide, thermoplastics and heat-resistant ceramics.
- Best conductivity and high contact force**
 Thanks to its design, the legendary high-strength steel screw clamp absorbs every geometric change to the connected conductor.



You can find out more information about the SAK series in our online catalogue.

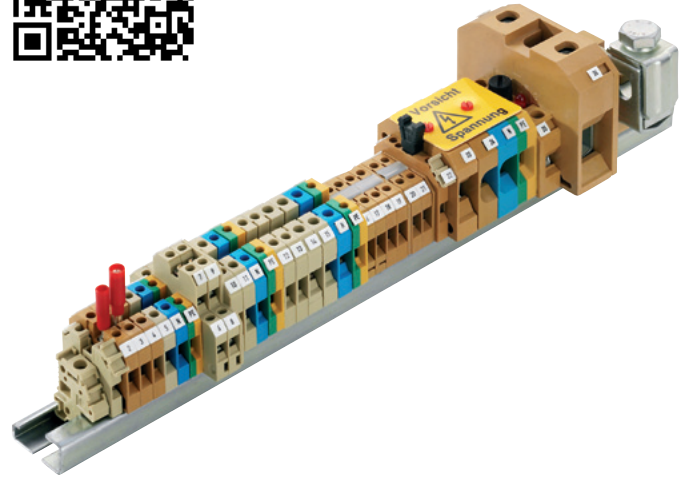

All materials checked for conformity with the latest environmental directives and RoHS requirements.

Versions

- Cross-sections from 0.5 to 35 mm²
- TS 32/TS 35 "2 in 1" combination foot

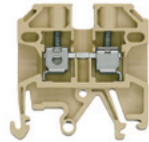

- Cross-sections from 0.5 to 95 mm²
- Special foot for TS 35
- Special foot for TS 32

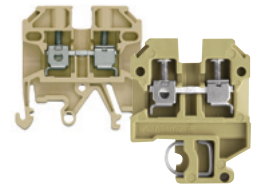

Product assortment

Terminal type	Rated cross-section						Flat-blade connection	Faston-connection	Spring loaded	Solder connection
	2.5 mm ²	4 mm ²	6 mm ²	10 mm ²	16 mm ²	35 mm ²				
Feed-through terminals										
PA 6.6 / TS 32	•	•	•	•	•	•		•	•	•
KRG / TS 32	•	•	•	•	•	•	•	•	•	•
PA 6.6 / TS 35	•	•	•	•	•	•		•	•	•
KRG / TS 35	•	•	•	•	•	•	•	•	•	•
PA 6.6 / combination foot	•	•	•	•	•	•				
PA 6.6 / TS 15	•	•							•	
Double level terminals		•								
PE terminals										
PA 6.6 / TS 32	•	•		•	•	•				
PA 6.6 / TS 35	•	•	•	•	•	•				
PA 6.6 / TS 15	•	•								
Fuse terminals										
PA 6.6 / TS 32				•						
PA 6.6 / TS 35				•						
KrG / TS 32				•	•					
KrG / TS 35				•	•					
PA 6.6 / TS 15		•								
PA 6.6 / combination foot		•								
Double level fuse terminals										
PA 6.6 / TS 32		•								
PA 6.6 / TS 35		•								
PA 6.6 / combination foot		•								
Disconnect test terminal blocks										
TS 35		•		•						
PA 6.6 / TS 15		•								
Two-tier disconnect test terminals		•						•		
Ceramic terminals		•		•						

1 The connection

Separation of electrical and mechanical functions:

- Clamping yoke and clamping screw made from hardened steel for high contact forces.
- A copper current bar for a low through resistance. The tin-plated surface guarantees minimum contact resistance.
- Gas-tight clamping point.
- Clamping point suitable for a wide range of cross-sections.

2 Cross-connection channel

- Any number of poles can be created by stacking the pre-fitted cross-connections.

3 Easy to use

- Built-in reserve when undoing the clamping screw – particularly important for mechanical screwing tools.
- Recessed clamping screw position provides a guide for the screwdriver.
- All parts fitted captive within the terminal.
- Numerous labelling options.

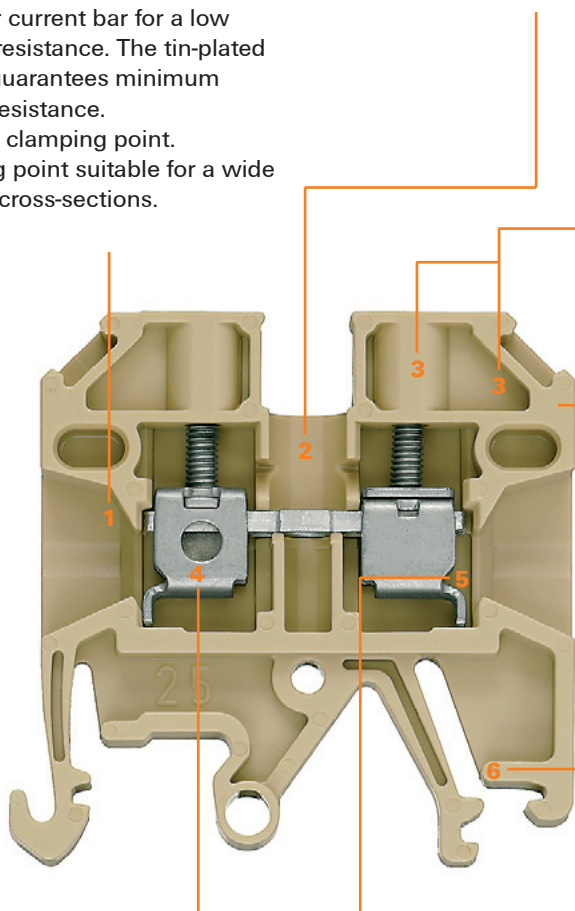

Insulating materials and max. temperatures

- PA – 100 °C
- KrG – 130 °C
- EP – 160 °C
- Ceramic – 250 °C

6 3 different snap-on feet

4 Reliable contact

- The steel clamping yoke compensates for temperature-induced changes to the conductor (no gradual loosening) required.
- Low-maintenance, vibration-resistant connection – no need to retighten the clamping screw.
- The highest contact force of any connection system – and in a compact space.

5 Safe to use

- Terminals supplied with open clamping point
- Yoke tab prevents incorrect insertion of conductors.

Standards and directives

The reliable contact and dependability of the Weidmüller systems are verified by:

- Type tests to IEC 6047-7-1/2
- National and international approvals
- A large portfolio of UL and CSA approvals
- ATEX approval
- IECEx approved



Shield connection terminals KLBÜ

Shield connection terminals KLBÜ	Overview shield connection terminals KLBÜ	E.2
	Shield connection terminals KLBÜ for 10 x 3 mm busbars	E.6
	Shield connection terminals KLBÜ - Mounting directly on metal plate	E.10
	Shield connection terminals KLBÜ - Mounting on TS 35	E.12
	Shield connection terminals KLBÜ for C-rails	E.13
	Shield connection solutions for direct wiring	E.14
	Functional earthing (PE terminals)	E.15

Weidmüller shield connections

Comprehensive and self-adjusting shield contacts

Shield connections automatically adjust themselves using the spring principle to deal with temperature-related, cross-sectional changes and are also ideal for applications with vibrations. The large contact surface area and the short connection length to the rail or mounting plate ensures optimal contact over a wide frequency band. This ensures that assembly is simple and secure.

E



Optimal and sustainable

There is a suitable solution for every installation, safe and reliable thanks to the spring force.

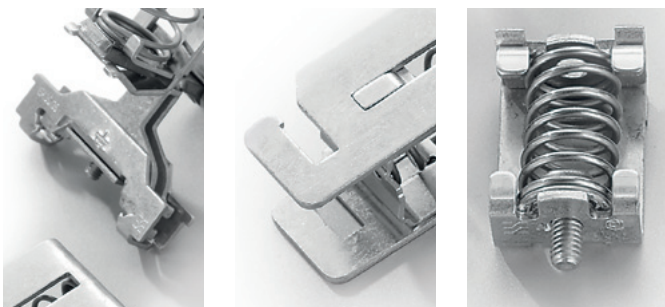

Guaranteed contact reliability

Be it transient surge voltages or electromagnetic fields in the area, coupling is safely prevented. The self-adjusting shield connection improves your productivity.

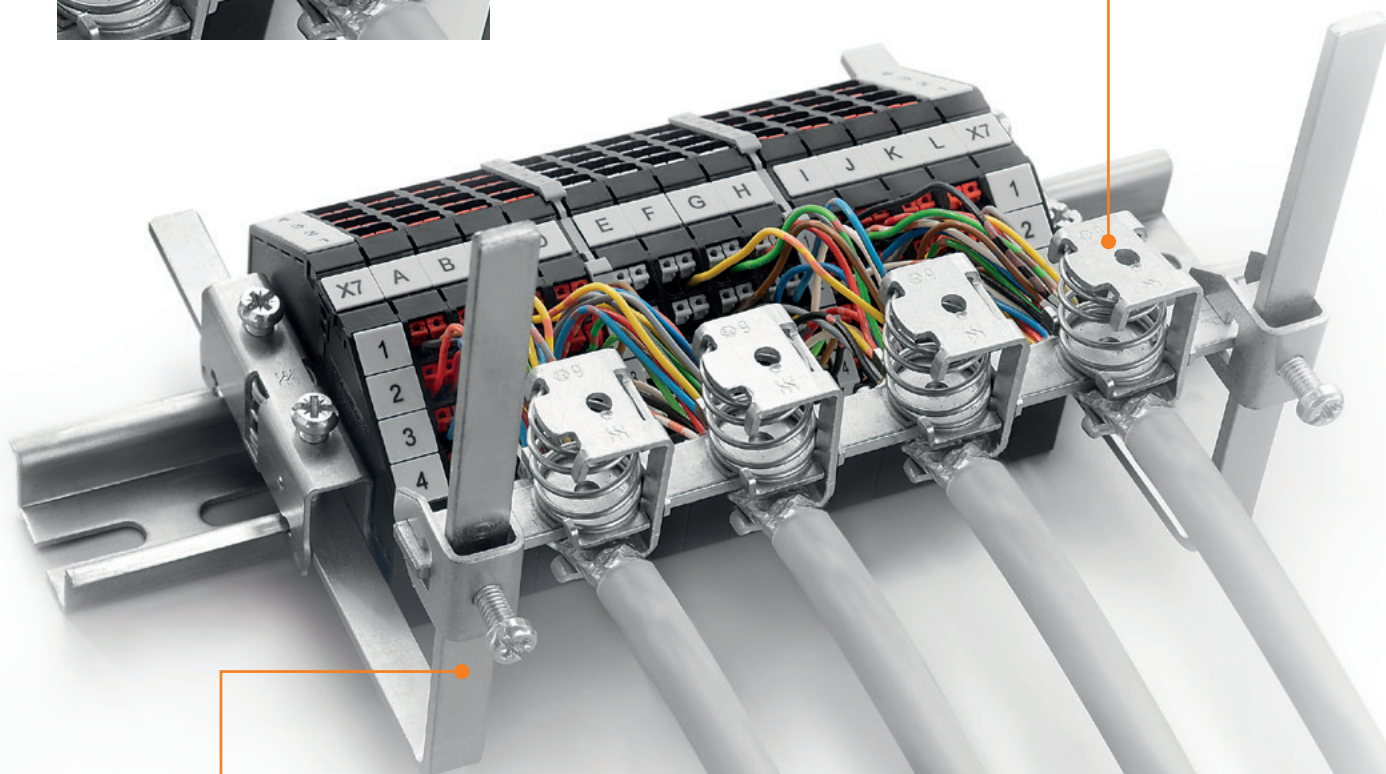
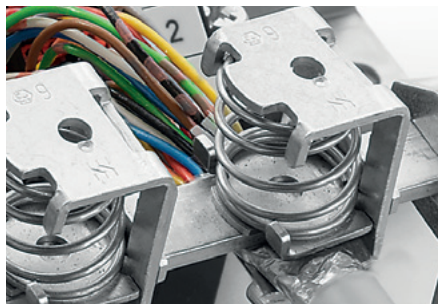

E

Simply brilliant

The operating principles and assembly are both immediately clear and ensure clarity through the whole series.

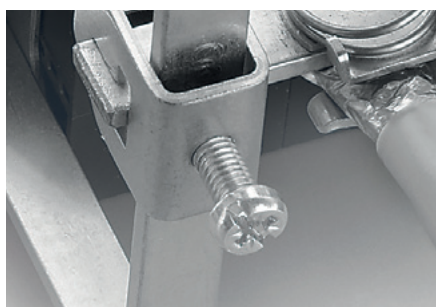

Tailor made accessories

Weidmüller offers the accessories needed to ensure optimum shielding, they are tailor made to make your build simple, safe and quick.



The theoretical concept

Part 1 of the VDE 0133 standard specifies the required equipotential bonding for the electrical components of a machine. The aim is to prevent any undesirable consequences occurring as a result of electrostatic, electromagnetic and net-work bound interference.

The following measures serve this purpose:

- Use filter and time delays.
- Reference (ground) potentials split into "dirty" and "clean".
- Neutral earthing of all reference potentials with large diameters ($\geq 6 \text{ mm}^2$).
- Earth connections selected should be as short as possible.
- All connections should be routed in parallel to the earthing plane.
- Use shielded cables. When possible, the shield should be earthed at both ends.
- Isolate and shield switching devices and components susceptible to interference.

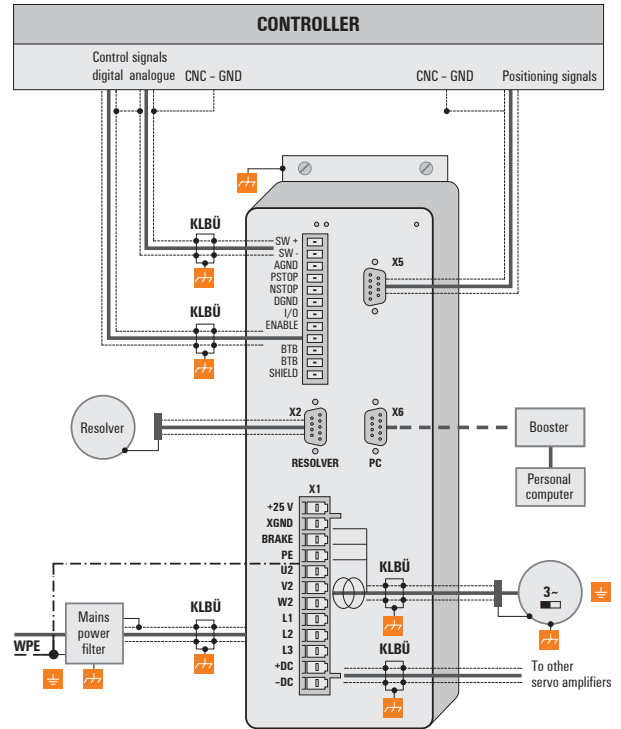

Overview of KLBÜ fittings available

For busbars
10 x 3



For direct mounting



For C-profiles



For TS 35
insulating/conducting



Clip on for
10 x 3 busbar



For direct wiring in
2.5 mm² Z terminals



In detail

Compression spring

- To ensure both simple handling and proper connection with permanent contact pressure as a result of the spring effect



No extra tools necessary

- Simply **swivel onto the busbar by hand** – retrospectively if necessary

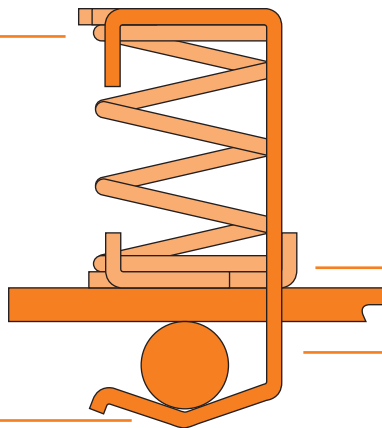

Full range

- For conductors from 2 to 37 mm diameter

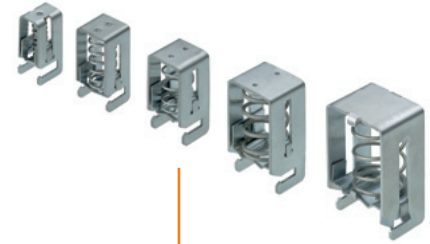

Reliable contact

- Changes in diameter (flow) of the conductor compensated for by the elastic behaviour of the clamping yoke for flexible adjustment to the cable diameter

Many options available

- Weidmüller offers a wide range of different fastenings for mounting shield connection terminals

Shield connection terminals KLBÜ for 10 x 3 mm busbars

Clamping yoke

Cable fastened against the busbar from the top

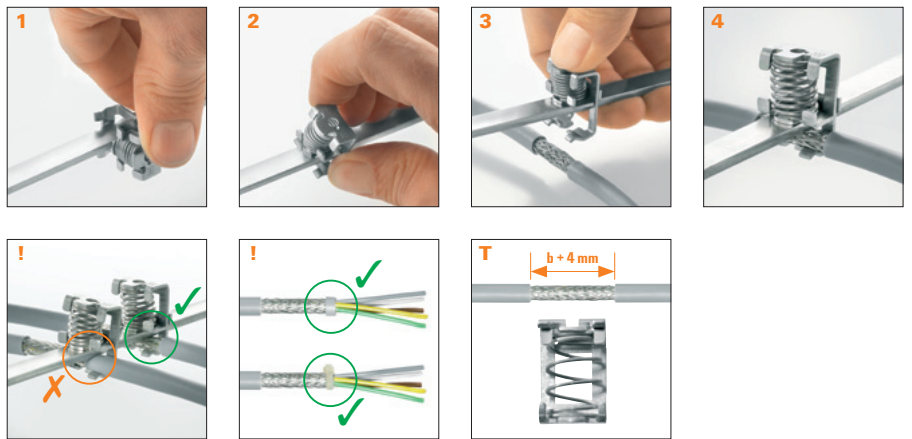
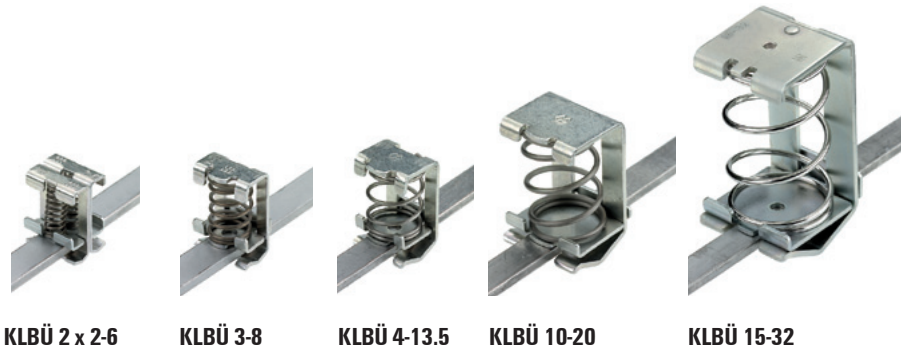
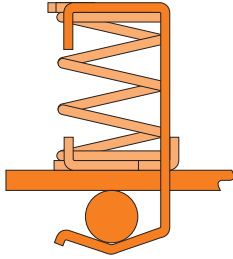

KLBÜ

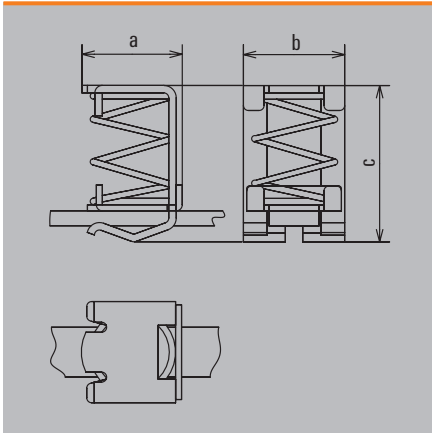

Ordering data

Type	For cable diameter	Dimensions (a x b x c) mm	Qty.	Order No.
KLBÜ 2 x 2-6	2.0 ... 6.0 mm	15.0 x 18.0 x 24.0	10	1675350000
KLBÜ 3-8	3.0 ... 8.0 mm	13.0 x 18.0 x 26.0	10	1600480000
KLBÜ 4 x 13.5	4.0 ... 13.5 mm	20.0 x 20.5 x 31.5	10	1592810000
KLBÜ 10-20	10.0 ... 20.0 mm	25.0 x 26.0 x 40.0	10	1600490000
KLBÜ 15-32	15.0 ... 32.0 mm	36.0 x 32.0 x 63.9	10	1716300000

10 x 3 mm busbars	Length	Material	Qty.	Order No.
SSch 10 x 3 x 1000 Cu, Sn	1000.0 mm	Cu, Sn	1	0348900000

Clamping yoke

Cable fastened against the busbar from the top

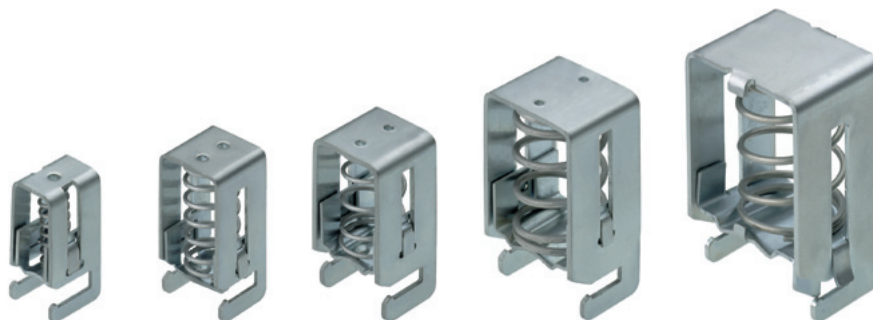
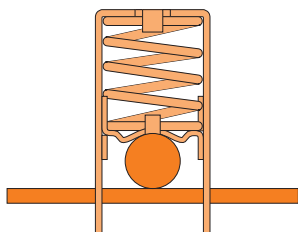

KLBÜ CO 1 KLBÜ CO 2 KLBÜ CO 3 KLBÜ CO 4 KLBÜ CO 5

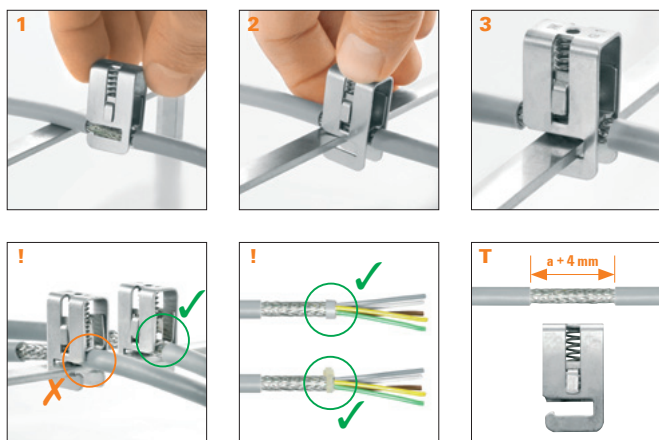

KLBÜ CO

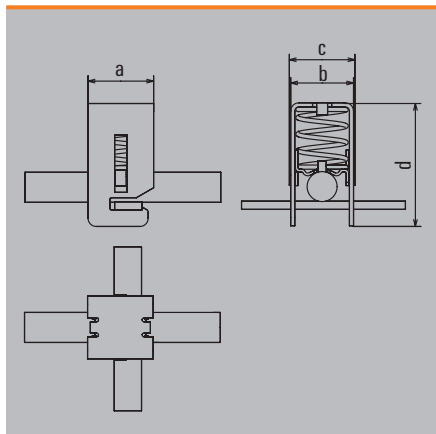

Ordering data

Type	For cable diameter	Dimensions (a x b x c) mm	Qty.	Order No.
KLBÜ CO 1	3.0 ... 10.0 mm	18.0 x 12.0 x 13.2 x 32.0	10	1753311001
KLBÜ CO 2	4.0 ... 15.0 mm	18.0 x 20.0 x 21.1 x 41.6	10	1752131001
KLBÜ CO 3	10.0 ... 20.0 mm	25.0 x 23.0 x 24.0 x 45.0	10	1749151001
KLBÜ CO 4	15.0 ... 28.0 mm	25.0 x 31.0 x 32.0 x 56.0	10	1749161001
KLBÜ CO 5	20.0 ... 37.0 mm	32.0 x 40.0 x 42.7 x 64.5	10	1755081001

10 x 3 mm busbars	Length	Material	Qty.	Order No.
SSch 10 x 3 x 1000 Cu, Sn	1000.0 mm	Cu, Sn	1	0348900000

Shield connection terminals KLBÜ for 10 x 3 mm busbars

Busbar holders

Insulated mounting on TS 35

Type WSH 1

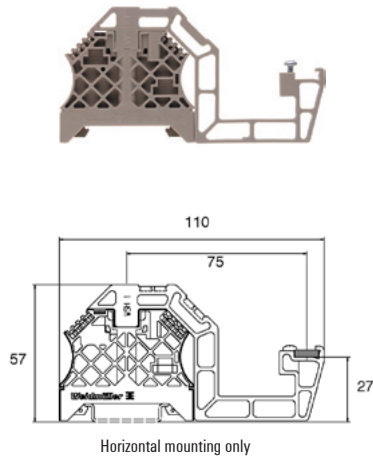

Type WSH 3/H/N

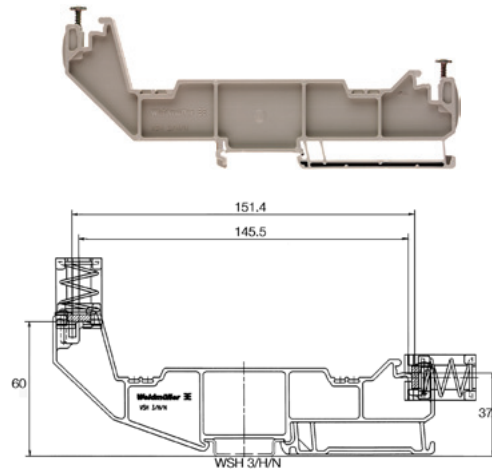

Type WSH 5

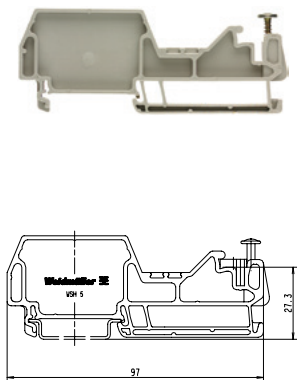

Type WSH 6

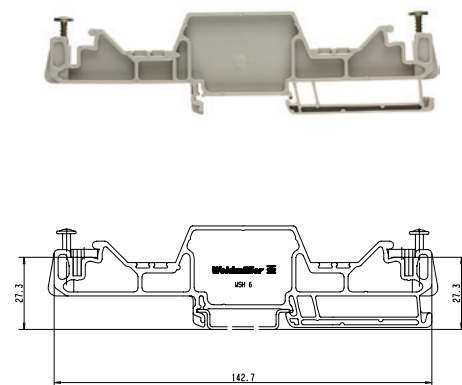

WSH

Ordering data

Type	Width	Qty.	Order No.
WSH 1	8.0 mm	10	1068700000
WSH 3/H/N	8.0 mm	10	1715970000
WSH 5	8.0 mm	10	1080100000
WSH 6	8.0 mm	10	1080200000

10 x 3 mm busbars	Length	Material	Qty.	Order No.
SSch 10 x 3 x 1000 Cu, Sn	1000.0 mm	Cu, Sn	1	0348900000

Busbar holders

Conductive mounting on TS 35

TS 35-Clip

BS 35/WSH 2



Busbar connector

BFEH 1/WSH



Angled rail

SMSE WSH U1MT



SMSE WSH 135/60 MT



Installation example 1

- One busbar
- 2 x WSH 19 MT busbar holder set

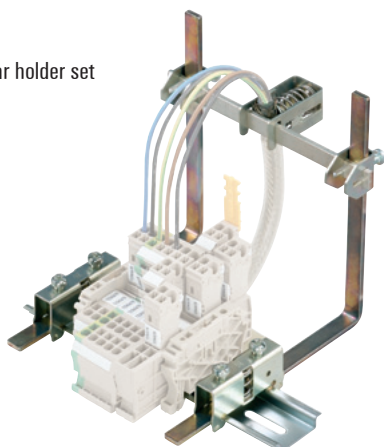

Installation example 2

- Two busbars
- 2 x WSH 18 MT busbar holder set

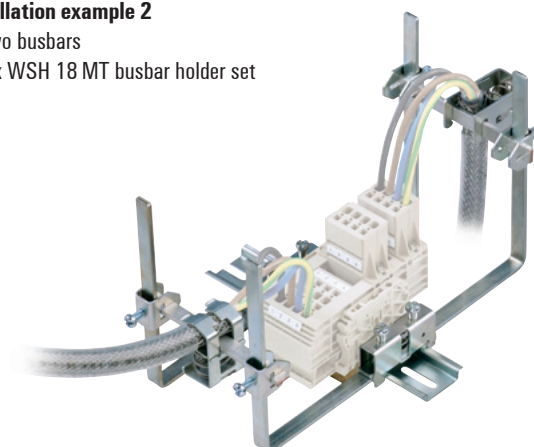

WSH

Ordering data

TS 35-Clip	Dimensions (L x B x H) mm			Qty.	Order No.	
BS 35/WSH 2	52.0 x 37.0 x 13.0			10	1760720000	
Busbar connector	Dimensions (L x B x H) mm			Qty.	Order No.	
BFEH 1/WSH	20.0 x 31.0 x 13.5			10	1082400000	
Angled rail	Dimensions (L x B x H) mm			Qty.	Order No.	
SMSE WSH U1MT	134.0 x 10.0 x 134.0			10	1083900000	
SMSE WSH 135/60 MT	60.0 x 10.0 x 60.0			10	1246990000	
Busbar holder sets	Contents (parts loose in plastic bag)				Qty.	Order No.
	BS 35/WSH 2	BFEH 1/WSH	SMSE WSH U1MT			
WSH 18 MT	1 pcs.	2 pcs.	2 pcs.	10	1083100000	
WSH 19 MT	1 pcs.	1 pcs.	1 pcs.	10	1083200000	
10 x 3 mm busbars	Länge	Material	Qty.	Order No.		
SSch 10 x 3 x 1000 Cu, Sn	1000.0 mm	Cu, Sn	1	0348900000		

Shield connection terminals KLBÜ – Mounting directly on metal plate

Busbar holder / Spacer

Busbar holder

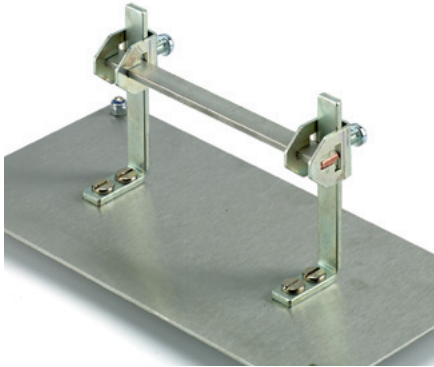

Set (WSH 4 MT) consisting of:
 - 1 busbar holder
 - 1 busbar connector (BFEH 1/WSH)

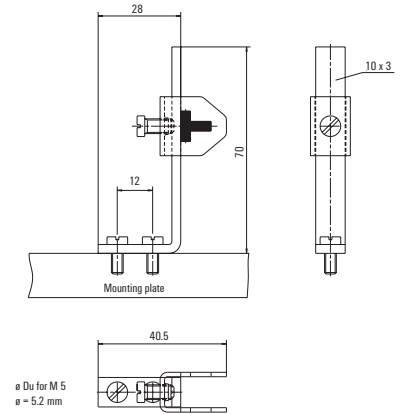

Spacer

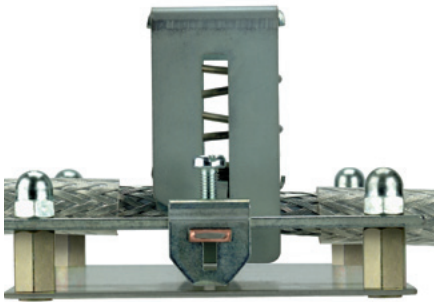

M6 outer and inner thread
 (15 mm, 20 mm and 30 mm long)



WSH 4 MT / SP

Ordering data

Busbar holder		Qty.	Order No.
WSH 4 MT		10	1079900000

Spacer	Length	Qty.	Order No.
SP 15 set of 2	15 mm	1	3896100000
SP 20 set of 2	20 mm	1	3896200000
SP 30 set of 2	30 mm	1	3896300000

Clamping yoke

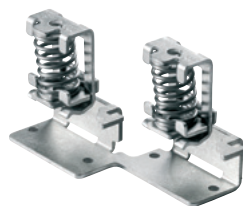
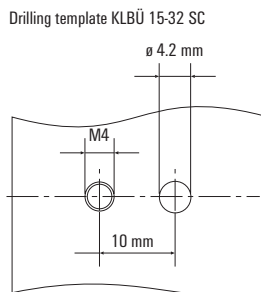
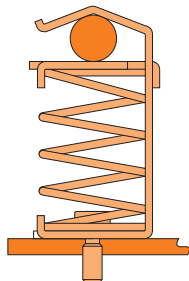

SCH-1-WB



KLBÜ 3-8 SC



KLBÜ 4-13.5 SC



KLBÜ 10-20 SC



KLBÜ 15-32 SC

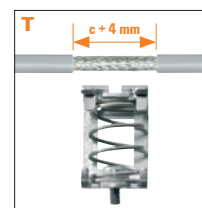
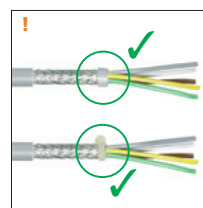
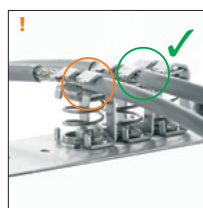
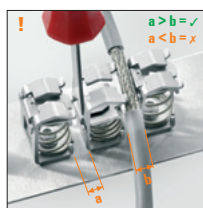
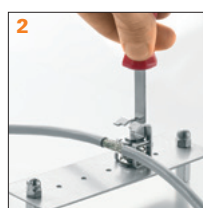

KLBÜ SC

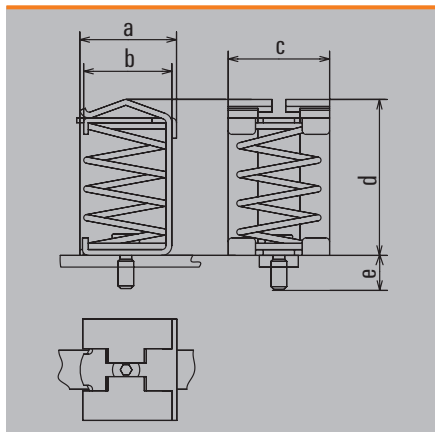

Ordering data

Type	For cable diameter	Thread length	Dimensions (a x b x c) mm	Qty.	Order No.
SCH-1-WB	3.0 ... 8.0 mm		32.5 x 33.3 x 70.3 x 39.0	5	1739890000
KLBÜ 3-8 SC	3.0 ... 8.0 mm	5.65 mm	13.5 x 11.5 x 18.0 x 26.0	10	1692261001
KLBÜ 4-13.5 SC	4.0 ... 13.5 mm	5.30 mm	20.0 x 17.8 x 20.3 x 31.4	10	1712311001
KLBÜ 10-20 SC	10.0 ... 20.0 mm	5.30 mm	24.8 x 23.0 x 26.0 x 40.0	10	1712321001
KLBÜ 15-32 SC	15.0 ... 32.0 mm	4.80 mm	36.0 x 33.3 x 32.0 x 64.0	10	1718341001
Self-tapping screw				Qty.	Order No.
KLBUE 3-8 SDSC	3.0 ... 8.0 mm		36.0 x 33.3 x 32.0 x 64.0	10	1835840000
Operating tool				Qty.	Order No.
BTWZ KLBÜ				1	1742630000



Shield connection terminals KLBÜ – Mounting on TS 35

FM 4 foot / Clamping yoke holder

FM 4 foot



The KLBÜ SC clamping yokes (see page E.11) are screwed onto the **FM 4 foot**.

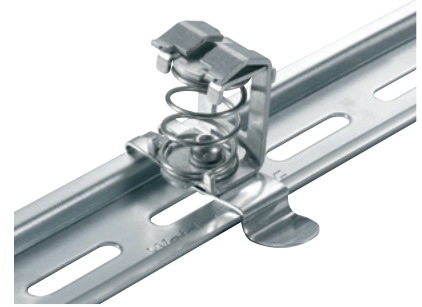

KLBÜ 4-13.5 FM4

Clamping yoke holder

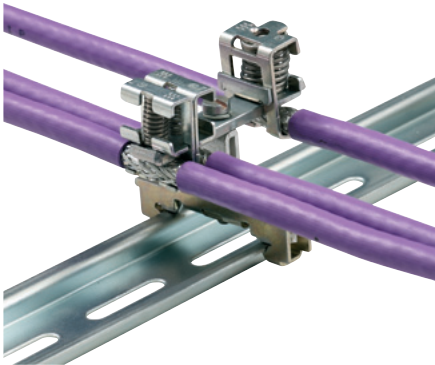

BS 35 II (without KLBÜ)

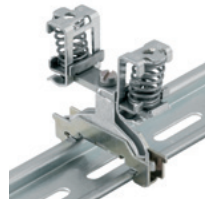

BS 35 II / KLBÜ 3-8



BS 35 II / KLBÜ 3-8 / 2 x 2-6

FM 4 / BS 35 II

Ordering data

FM 4 foot	Qty.	Order No.
FM 4	40	0687900000
Clamp fitted with FM 4 foot		
KLBUE 3-8 FM4	10	1252530000
KLBUE 4-13.5 FM4	10	1252520000
KLBUE 10-20 FM4	10	1252510000
KLBUE 15-32 FM4	10	1252490000
Clamping yoke holder		
BS 35 II	without KLBÜ	Qty. 10, Order No. 1723800000
BS 35 II / KLBÜ 3-8	3.0 ... 8.0 mm	Qty. 10, Order No. 1723810000
BS 35 II / KLBÜ 4-13.5	4.0 ... 13.5 mm	Qty. 10, Order No. 1723820000
BS 35 II / KLBÜ 3-8/2 x 2-6	3.0 ... 8.0 mm / 2.0 ... 6.0 mm	Qty. 10, Order No. 1749430000
BS 35 II / KLBÜ 2 x 3-8/2 x 2-6	3.0 ... 8.0 mm / 2.0 ... 6.0 mm	Qty. 10, Order No. 1768020000

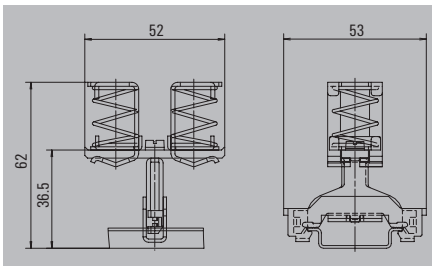

Clamping yoke

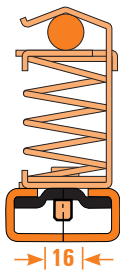
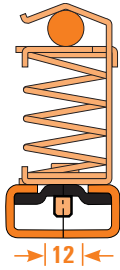

KLBÜ 3-8 CPF



KLBÜ 4-13.5 CPF



KLBÜ 10-20 CPF



KLBÜ 15-32 CPF



KLBUE 4-13.5 CPF16



KLBUE 10-20 CPF16



KLBUE 15-32 CPF16

KLBÜ CPF

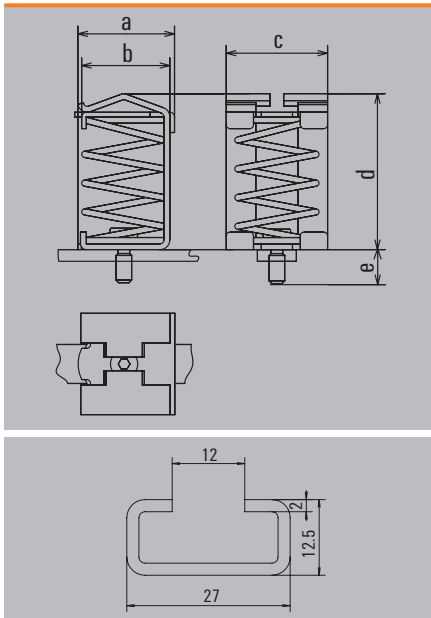

Ordering data

Type for 12 mm profile	For cable diameter	Dimensions (a x b x c x d) mm	Qty.	Order No.
KLBÜ 3-8 CPF	3.0 ... 8.0 mm	13.5 x 11.5 x 18.0 x 26.0	10	1752681001
KLBÜ 4-13.5 CPF	4.0 ... 13.5 mm	20.0 x 17.8 x 20.3 x 31.4	10	1752691001
KLBÜ 10-20 CPF	10.0 ... 20.0 mm	24.8 x 23.0 x 26.0 x 40.0	10	1752701001
KLBÜ 15-32 CPF	15.0 ... 32.0 mm	36.0 x 33.3 x 32.0 x 64.0	10	1752711001

Type for 16 mm profile	For cable diameter	Dimensions (a x b x c x d) mm	Qty.	Order No.
KLBUE 4-13.5 CPF16	4.0 ... 13.5 mm	20.0 x 17.8 x 20.3 x 31.4	10	1167850000
KLBUE 10-20 CPF16	10.0 ... 20.0 mm	24.8 x 23.0 x 26.0 x 40.0	10	1252550000
KLBUE 15-32 CPF16	15.0 ... 32.0 mm	36.0 x 33.3 x 32.0 x 64.0	10	1252540000

C-rail	Qty.	Order No.
TS 27 x 12.5M / ST / F.ZN	10 m	1802690000

Shield connection solutions for direct wiring

Shielding solutions for direct connection



KLBÜ 4-6 Z/1

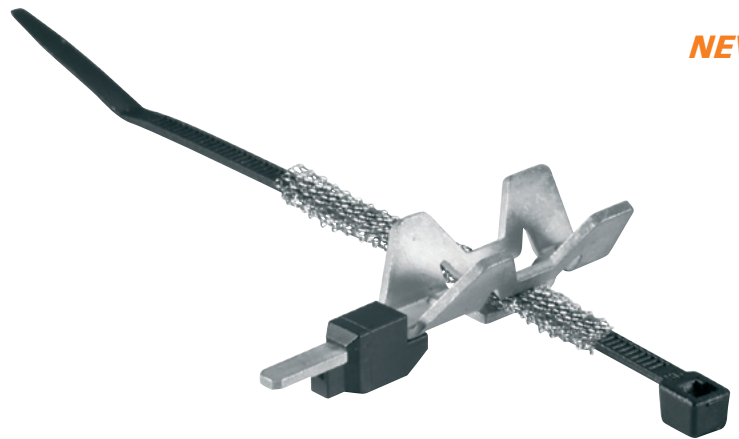

EMC set

NEW

E

Ordering data

Type for 12 mm profile	For cable diameter	Qty.	Order No.
KLBÜ 4-6 Z/1	4.0 ... 6.0 mm		2269800000
Note: Suitable for 2.5 mm ² Z-series			
		Qty.	Order No.
EMC-Set		1	1067470000
EMC-CONTACT		1	1067520000
EMC-TIE		1	1067490000

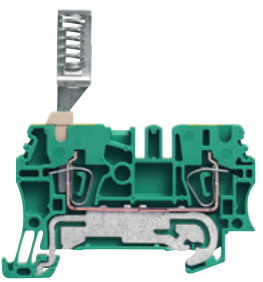
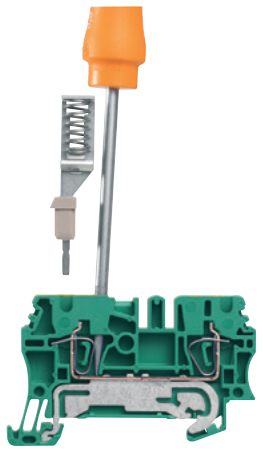

Functional earth

Functional earth

The functional earth is an equipotential bonding mechanism that is used to discharge shield-coupled transient currents. It can also have an earth function to prevent sensitive devices from damage. The same applies for couplings to grounding lines inside equipment – these must also be discharged. DIN VDE 0113 and VDE 0197 differ according to FE and PE: because there is a degree of freedom when designing the functional earth, but the protective earth must be conform with clear requirements. PE terminal blocks which are intended to protect human life must be labelled green-yellow. They can still be used for functional earthing although. White PE terminals (FE) can be used as the functional earth. Even the symbols used here have been extended in order to clarify the functional earth. In contrast to the protective earth, a meshing is not useful for the functional earth: instead wiring in a star topology makes more sense. This creates a so-called “clean” earth because compensation currents are not possible when this type of wiring is used. In such a case, the key is a low-impedance connection. The length of the line is also a critical factor.

For systems where this distinction must or should be made, Weidmüller offers white PE terminal blocks from the W- and Z-series. These terminals are easily identified through their colouring, showing that the circuits are only there to functionally protect the electrical systems that are connected.

Symbol for functional earthing

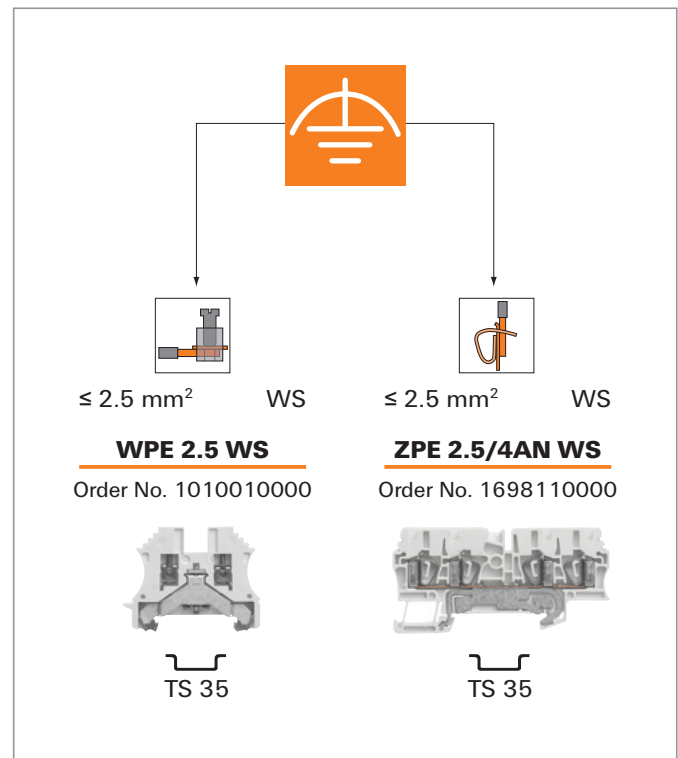

E

Accessories

Accessories	Busbars	F.2
	Terminal rails	F.8
	End brackets	F.12
	Terminal rail supports / Mounting feet	F.13
	Cover strips and retaining plates	F.15
	Terminal markers	F.16
	Printing systems and software	F.35
	Tools	F.42
	Wire end ferrules	F.66
	Insulated cable connectors	F.78

Busbars

In switching facilities and controllers, the N conductor may need to be merged with the PE conductor at a central point. For this reason, busbars are available that allow a wide range of cables to be connected within a confined space (up to 70 wires on one metre of rail). The cables are connected via a compression piece or a clamping yoke. A guide lug at the compression piece grips into the busbar and holds tightly to the compression piece. The clamping yokes can be moved on the busbar and adjusted to the whole wiring in the facility. The busbar can be used without holes in various lengths. The SH rail holding clamp is used for fastening. On longer rails, it can also be aligned between clamping yokes.

In order to bring together neutral conductors and protective conductors at a central point, it is advantageous to use ZB cable clamps together with 10 x 3 or 6 x 6 busbars. The cable clamps can be pushed onto the busbar and adjusted to the entire wiring in the system. The cable clamp serves as the protective conductor connection and can be supplied with green/yellow insulating caps. These caps indicate the protective function and marking tags allow clear identification of each conductor. If the cable clamps are used to connect neutral conductors, they can be marked with a blue insulating cap.

ZBE 6 can also be swivelled onto the busbar retrospectively.

F

Cable clamps

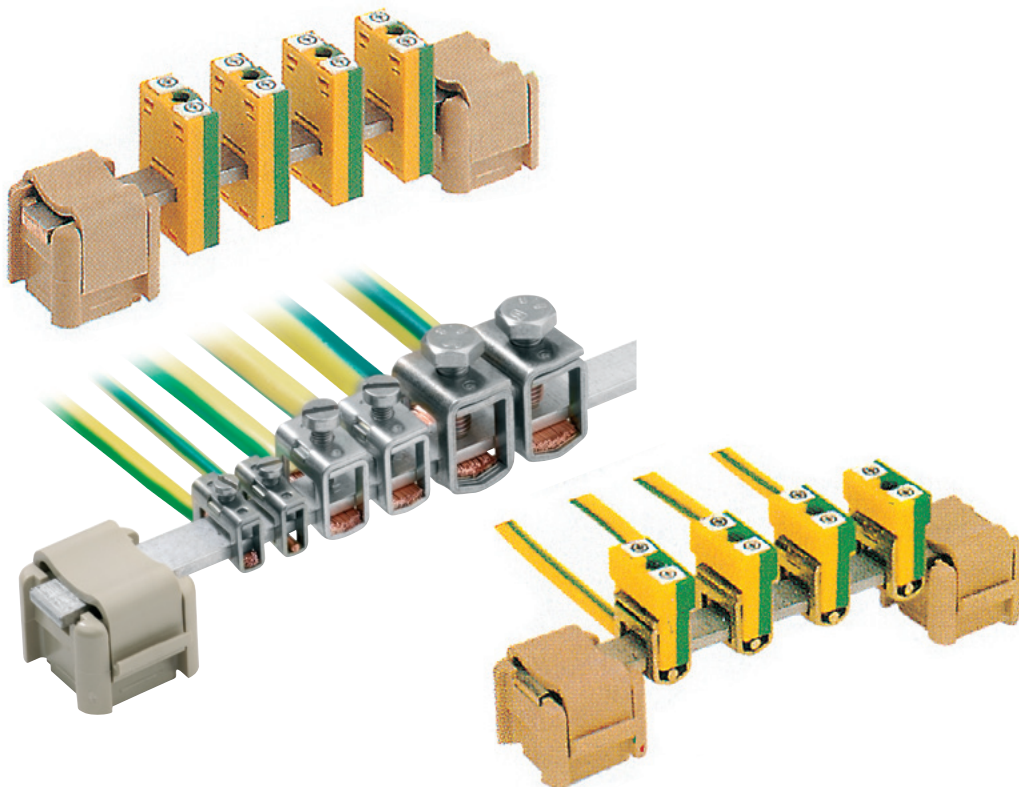

Busbars, unperforated

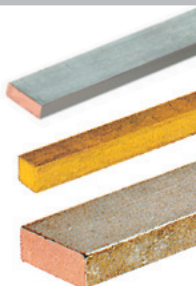

SSch

Type	Material	Cross-section	Length	Current carrying capacity	Qty.	Order No.
SSch 10 x 3	Copper, tin-plated	10 x 3 mm	1 m	140 A	1	0348900000
SSch 10 x 3	Steel, galvanised	10 x 3 mm	1 m		1	0438000000
SSch 10 x 3	Brass, blank	10 x 3 mm	1 m	100 A	1	0259800000
SSch 6 x 6	Copper, tin-plated	6 x 6 mm	1 m	140 A	1	0571300000
SSch 15 x 6	Copper, tin-plated	15 x 6 mm	1 m	265 A	1	0357400000

Busbars, perforated

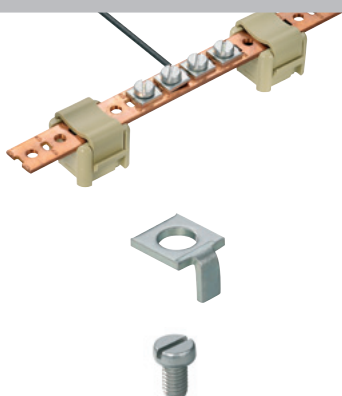

NSch / ESch

Type	Material	Cross-section	Length	Current carrying capacity	Qty.	Order No.
NSch 15 x 2	Copper, blank	15 x 2 mm	1 m	80 A	1	0280200000
ESch 12 x 2	Steel, galvanised	12 x 2 mm	1 m		1	0280300000
NSch 2M	Copper, blank	15 x 2 mm	2 m	80 A	1	1313600000

Pressure piece	Qty.	Order No.
DKSUE	100	0280100000
Clamping screw	Qty.	Order No.
BFSC M5 x 8	100	0296700000

Connection data NSch / ESch

Screw connection solid	0.5 ... 2.5 mm ²
Stripping length	9 mm
Cable lug connection	max. 16 mm ²
Max. current per connection	27 A

Busbar holders

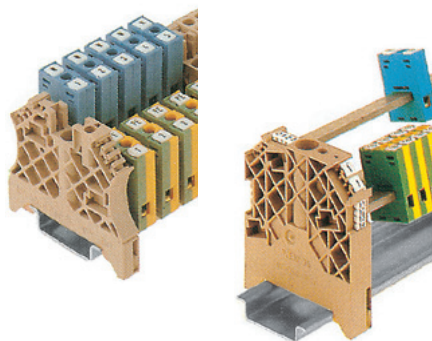

WEW

Type	For busbar cross-section	Qty.	Order No.
WEW 35/1	10 x 3, 6 x 6	50	1059000000
WEW 35/1 SW	10 x 3, 6 x 6	100	1162600000
WEW 35/1 GR	10 x 3, 6 x 6	100	1227890000
WEW 35/2	10 x 3, 6 x 6	100	1061200000
WEW 35/2 SW	10 x 3, 6 x 6	100	1061210000
WEW 35/2 GR	10 x 3, 6 x 6	100	1859200000

WEW 35/1 and WEW35/2 as busbar holder together with the ZB 4 G tension clamp

Connection element

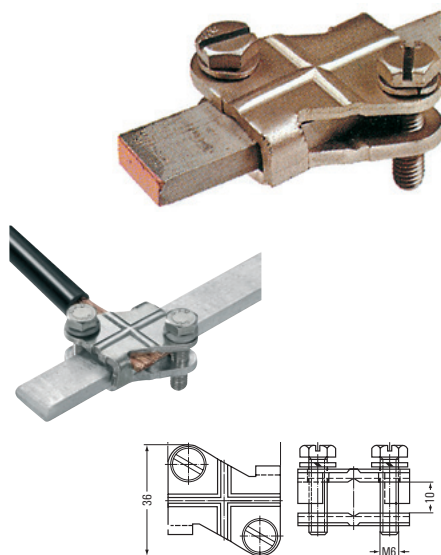

AK 95

Type	For busbar cross-section	Qty.	Order No.
AK 95	15 x 6 mm	10	0364200000

The AK 95 connection element is used as a tension clamp for 15 x 6 busbars

Connection cross-sections: Solid = 6...16 mm²
Flexible = 6...50 mm²
Stranded = 16...50 mm²

Busbars

Cable clamp, uninsulated

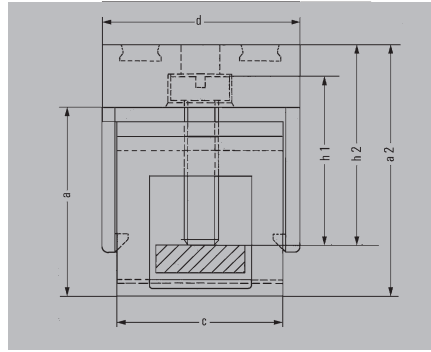

Tightening torques for clamping screws according to IEC 60947-1

Products with screw with slotted head		
Thread	Tightening torque	
	Steel screws	A 2/A 4-80
	min. 8.8 [Nm]	0.2...0.35 [Nm]
M 2	0.2...0.35	0.2...0.35
M 2.5	0.4...0.8	0.4...0.8
M 3	0.5...1.0	0.5...1.0
M 3.5	0.8...1.6	0.8...1.6
M 4	1.2...2.4	...
M 5	2.0...4.0	...
M 6	2.5...5.0	...

For 10 x 3 mm busbars

	Connection cross-section:		
	Solid	0.5 ... 6.0 mm ²	
	Flexible	0.5 ... 4.0 mm ²	
	Stranded	-	
	Clamping screw	M 3	
	Stripping length	16 mm	

For retrofitting

	Connection cross-section:		
	Solid	1.0 ... 10 mm ²	
	Flexible	1.5 ... 10 mm ²	
	Stranded	-	
	Clamping screw	M 4	
	Stripping length	19 mm	

Also for 10 x 5 mm busbar

	Connection cross-section:		
	Solid	1.5 ... 10 mm ²	
	Flexible	2.5 ... 10 mm ²	
	Stranded	-	
	Clamping screw	M 4	
	Stripping length	19 mm	

	Connection cross-section:		
	Solid	2.5 ... 16 mm ²	
	Flexible	2.5 ... 16 mm ²	
	Stranded	16 ... 25 mm ²	
	Clamping screw	M 4	
	Stripping length	16 mm	

	Connection cross-section:		
	Solid	16 ... 35 mm ²	
	Flexible	16 ... 35 mm ²	
	Stranded	16 ... 50 mm ²	
	Clamping screw	M 6	
	Stripping length	19 mm	

For 6 x 6 mm busbar

	Connection cross-section:		
	Solid	0.5 ... 6.0 mm ²	
	Flexible	0.5 ... 4.0 mm ²	
	Stranded	-	
	Clamping screw	M 3	
	Stripping length	16 mm	

	Connection cross-section:		
	Solid	2.5 ... 16 mm ²	
	Flexible	2.5 ... 16 mm ²	
	Stranded	16 ... 25 mm ²	
	Clamping screw	M 4	
	Stripping length	12 mm	

ZB / ZBE

Type	Colour	Dimensions [mm]				Qty.	Order No.
		a	Width	c	h1		
ZB 4, blank	-	11.7	5.6	16.0	10.0	50	0316500000
Insulating cap	blue					50	0475480000
Insulating cap	green / yellow					50	0475460000

ZBE 6, blank	-	19.5	8.2	19.5	19.0	50	0459500000
Insulating cap	green / yellow					50	0526060000

ZB 10, blank	-	19.5	8.2	19.5	19.0	50	1261300000
--------------	---	------	-----	------	------	----	------------

ZB 16, blank	-	17.0	10.0	16.0	17.0	50	0316600000
Insulating cap	blue					50	0502980000
Insulating cap	green / yellow					50	0502960000

ZB 35, blank	-	21.0	14.4	18.4	20.5	20	0266500000
Insulating cap	blue					50	0502780000

ZB

Type	Colour	Dimensions [mm]				Qty.	Order No.
		a	b	c	h1		
ZB 4/6, blank		14.7	5.6	12.5	10.0	50	0556700000

ZB 16/6, blank		19.0	10.0	12.5	17.0	50	0556800000
----------------	--	------	------	------	------	----	------------

Cable clamp, insulated

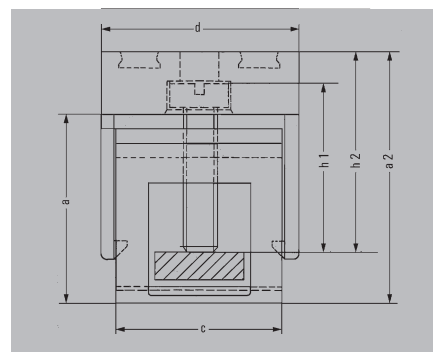

For 10 x 3 mm busbars

	Connection cross-section:	
	Solid	0.5 ... 6.0 mm ²
	Flexible	0.5 ... 4.0 mm ²
	Stranded	-
	Clamping screw	M 3
	Stripping length	16 mm

For retrofitting

	Connection cross-section:	
	Solid	1.0 ... 10 mm ²
	Flexible	1.5 ... 10 mm ²
	Stranded	-
	Clamping screw	M 4
	Stripping length	19 mm

	Connection cross-section:	
	Solid	2.5 ... 16 mm ²
	Flexible	2.5 ... 16 mm ²
	Stranded	16 ... 25 mm ²
	Clamping screw	M 4
	Stripping length	16 mm

	Connection cross-section:	
	Solid	-
	Flexible	16 ... 35 mm ²
	Stranded	16 ... 50 mm ²
	Clamping screw	M 6
	Stripping length	19 mm

Tension clamp connection

	Connection cross-section:	
	Solid	0.5 ... 4.0 mm ²
	Flexible	0.5 ... 2.5 mm ²
	Stranded	-
	Stripping length	10 mm

For 6 x 6 mm busbar

	Connection cross-section:	
	Solid	0.5 ... 6.0 mm ²
	Flexible	0.5 ... 4.0 mm ²
	Stranded	-
	Clamping screw	M 3
	Stripping length	16 mm

	Connection cross-section:	
	Solid	2.5 ... 16 mm ²
	Flexible	2.5 ... 16 mm ²
	Stranded	16 ... 25 mm ²
	Clamping screw	M 4
	Stripping length	12 mm

ZB / ZBE / ZF

Type	Colour	Dimensions [mm]				Qty.	Order No.
		a2	Width	d	h2		
ZB 4 G GN/GE	green/yellow	27.0	7.6	19.7	15.5	50	0322160000
ZB 4 G BL	blue	27.0	7.6	19.7	15.5	50	0322180000
ZB 4 G SW	black	27.0	7.6	19.7	15.5	50	0322110000
ZB 4K GN/GE	green/yellow	18.5	6.0	19.0	13.0	50	0475360000
ZB 4K BL	blue	18.5	6.0	19.0	13.0	50	0475380000

ZBE 6K GN/GE	green/yellow	27.0	8.0	22.5	23.0	50	0525960000
ZBE 6K BL	blue	27.0	8.0	22.5	23.0	50	0525980000
ZBE 6K SW	black	27.0	8.0	22.5	23.0	50	0525910000

ZB 16K GN/GE	green/yellow	24.0	10.0	19.2	20.0	50	0502860000
ZB 16K BL	blue	24.0	10.0	19.2	20.0	50	0502880000

ZB 35K GN/GE	green/yellow	25.0	14.4	32.0	20.5	20	0502660000
ZB 35K BL	blue	25.0	14.4	32.0	20.5	20	0502680000
ZB 35K SW	black	25.0	14.4	32.0	20.5	20	0502610000

ZF 4 S	beige	22.0	6.1	24.5	-	50	1814680000
ZF 4 S BL	blue	22.0	6.1	24.5	-	50	1814660000
ZF 4 S GN/GE	green/yellow	22.0	6.1	24.5	-	50	1814670000

ZB 4/6K GN/GE	green/yellow	21.2	6.0	25.0	14.0	50	0565460000
ZB 4/6K BL	blue	21.2	6.0	25.0	14.0	50	0565480000

ZB

Type	Colour	Dimensions [mm]				Qty.	Order No.
		a2	b	d	h2		
ZB 4/6K GN/GE	green/yellow	21.2	6.0	25.0	14.0	50	0565460000
ZB 4/6K BL	blue	21.2	6.0	25.0	14.0	50	0565480000

ZB 16/6K GN/GE	green/yellow	26.0	9.7	25.0	20.0	50	0569660000
----------------	--------------	------	-----	------	------	----	------------

Terminal rail systems

Active and passive components, as well as intelligent modules, are mounted on terminal rails. This method has proved highly effective for decades. However, it is only after the use of certain consumables – which are frequently not taken into consideration – that electrical installation is finally completed. In this chapter, you will find a range of terminal rails and profile rails for component installation, together with end brackets for holding and isolating the components. These guarantee firm installation and isolation. Weidmüller supplies components which show perfect functional compatibility.

Terminal rails are made of either steel, stainless steel, aluminium, copper or plastic, depending on the area of application.

They can also be used as a protective conductor busbar. Weidmüller PE / earth terminals in the W-Series, Z-Series, I-Series, SAK- and AKZ-Series comply with requirements stipulated in IEC 60 947-7-2. According to VDE 0100 part 540, for conductors with cross-sectional areas exceeding 10 mm², both protective and neutral conductors may be grouped together as a single category of conductors designated PEN.

If a terminal rail is used as a PEN busbar, the following criteria must be observed:

- Only E-Cu or aluminium profiles are allowed
- Short-circuit currents and thermal rated currents must be taken into account
- The terminal rails are to be insulated as a contribution to protective insulation

Stainless steel

Stainless steel is a collective noun for all kinds of steel (alloys) which are smelted in a special process and have a high degree of purity. Stainless steel has a much-enhanced resistance to corrosion. Weidmüller's stainless steel terminal rails have the following composition: X5 CrNi 18-10 stainless steel (i.e. ~18 % chromium, ~10 % nickel).

Aluminium

Aluminium is second only to copper in its electrical conductivity. One advantage is its light weight. Aluminium oxidises quickly in air; thus passivated, it offers excellent corrosion protection.

Copper

Copper, a heavy metal, has the best electrical conductivity of all metals used. As it is a soft metal, Weidmüller's terminal rails are 2.3 mm thick.

Plastic

The plastic terminal rail scores on two counts: firstly, its insulating properties, and secondly, its low weight. This leads to its use in special applications where, for example, clearance and creepage distances with respect to the mounting plate cannot be achieved with the standard terminal rails.

Steel

The steel rail is the most widely used DIN rail on the market. Among metal DIN rails, it has the lowest short-circuit resistance, similar to stainless steel.



TS15 terminal rail



Unperforated

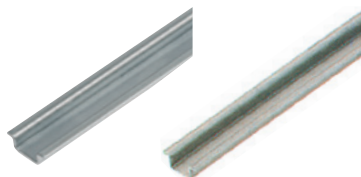

With slotted hole

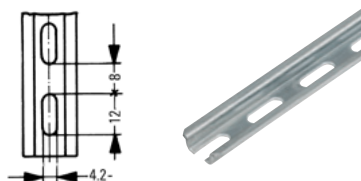

TS 15 x 5

Aluminium	Short-circuit strength corresponds to E-Cu wire	Material thickness	Length	Qty.	Order No.
TS 15x5 2M/AL/BK max. permissible rated current for PEN function = 76 A)	16 mm ²	1 mm	2 m	10 m	0134700000
Steel, galvanised and passivated					
TS 15x5 2M/ST/ZN	10 mm ²	1 mm	2 m	2 m	0514200000

Steel, galvanised and passivated					
TS 15x5/LL 2M/ST/ZN	10 mm ²	1 mm	2 m	2 m	0117500000
TS 15x5/LL 1M/ST/ZN	10 mm ²	1 mm	1 m	10 m	0117510000

TS 32 terminal rail

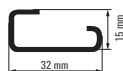

Unperforated



With slotted hole



TS 32 x 15

Aluminium	Short-circuit strength corresponds to E-Cu wire	Material thickness	Length	Qty.	Order No.
TS 32X15 2M/AL/BK (max. permissible rated current for PEN function = 192 A)	70 mm ²	1.5 mm	2 m	2 m	0169300000
Steel, galvanised and passivated					
TS 32X15 2M/ST/ZN	35 mm ²	1.5 mm	2 m	2 m	0122800000

Stainless steel					
TS 32X15 2M/CRN	35 mm ²	1.5 mm	2 m	2 m	0293220000

Steel, galvanised and passivated	Short-circuit strength corresponds to E-Cu wire	Material thickness	Length	Qty.	Order No.
TS 32X15/LL 2M/ST/ZN	35 mm ²	1.5 mm	2 m	2 m	0514400000

Terminal rails

TS 35 x 7.5 terminal rail



Unperforated

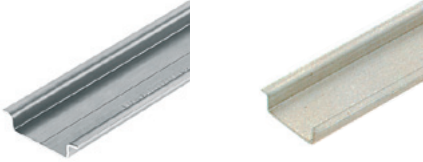

With slotted hole

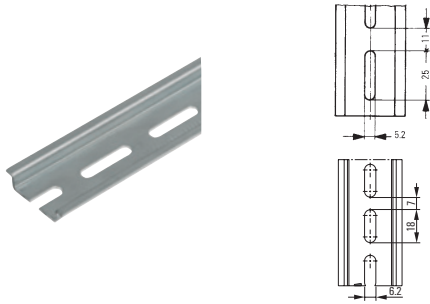

TS 35 x 7.5

Aluminium	Short-circuit strength corresponds to E-Cu wire	Material thickness	Length	Qty.	Order No.
TS 35X7.5 2M/AL/BK (max. permissible rated current for PEN function = 125 A)	35 mm ²	1 mm	2 m	2 m	0330800000
Steel, galvanised and passivated					
TS 35X7.5 2M/ST/ZN	16 mm ²	1 mm	2 m	2 m	0383400000
TS 35X7.5 1M/ST/ZN	16 mm ²	1 mm	1 m	10 m	0383410000
Stainless steel					
TS 35X7.5 2M/CRN	16 mm ²	1 mm	2 m	2 m	1747350000

Steel, galvanised and passivated	Short-circuit strength corresponds to E-Cu wire	Material thickness	Length	Qty.	Order No.
TS 35X7.5/LL 2M/ST/ZN	16 mm ²	1 mm	2 m	2 m	0514500000
TS 35X7.5/LL 1M/ST/ZN	16 mm ²	1 mm	1 m	10 m	0514510000

TS 35X7.5/LL/6 2M/ST/ZN	16 mm ²	1 mm	2 m	2 m	0514570000
-------------------------	--------------------	------	-----	-----	------------

TS 35 x 15 terminal rail



Unperforated

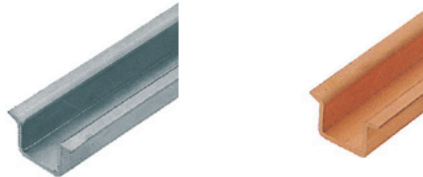

Unperforated



With slotted hole

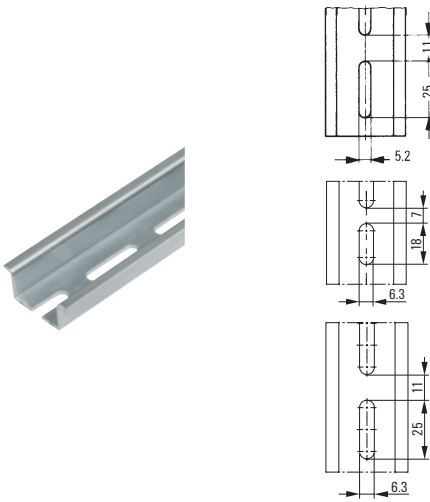

TS 35 x 15

Copper	Short-circuit strength corresponds to E-Cu wire	Material thickness	Length	Qty.	Order No.
TS 35X15/2.3 2M/CU/BK (max. permissible rated current for PEN function = 309 A)	150 mm ²	2.3 mm	2 m	2 m	0270100000
Steel, galvanised and passivated					
TS 35X15/2.3 2M/ST/ZN	50 mm ²	2.3 mm	2 m	2 m	0498000000

Aluminium	Short-circuit strength corresponds to E-Cu wire	Material thickness	Length	Qty.	Order No.
TS 35X15/2.3 2M/AL/BK (max. permissible rated current for PEN function = 192 A)	70 mm ²	2.3 mm	2 m	2 m	1848290000

Steel, galvanised and passivated	Short-circuit strength corresponds to E-Cu wire	Material thickness	Length	Qty.	Order No.
TS 35X15 2M/ST/ZN	25 mm ²	1.5 mm	2 m	2 m	0236400000

Steel, galvanised and passivated	Short-circuit strength corresponds to E-Cu wire	Material thickness	Length	Qty.	Order No.
TS 35X15/LL 2M/ST/ZN	25 mm ²	1.5 mm	2 m	2 m	0236500000
TS 35X15/LL 1M/ST/ZN	25 mm ²	1.5 mm	1 m	10 m	0236510000

TS 35X15/LL/6x18 2M/ST/ZN	25 mm ²	1.5 mm	2 m	2 m	1805980000
---------------------------	--------------------	--------	-----	-----	------------

TS 35X15/LL/6x25 2M/ST/ZN	25 mm ²	1.5 mm	2 m	2 m	1866290000
---------------------------	--------------------	--------	-----	-----	------------

TS 35 x 15 terminal rail



TSK 35 x 15

Plastic PVC RAL 7035	Length	Qty.	Order No.
TSK 35X15 2M PVC/GR	2 m	2 m	0514300000

TS 35 end caps

NEW

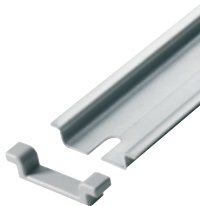

End cap TS 35 x 7.5	Qty.	Order No.
TS END CAP 35X7.5	100	1283470000
End cap TS 35 x 15		
TS END CAP 35X15	100	1283480000

End brackets

For TS 15 terminal rail

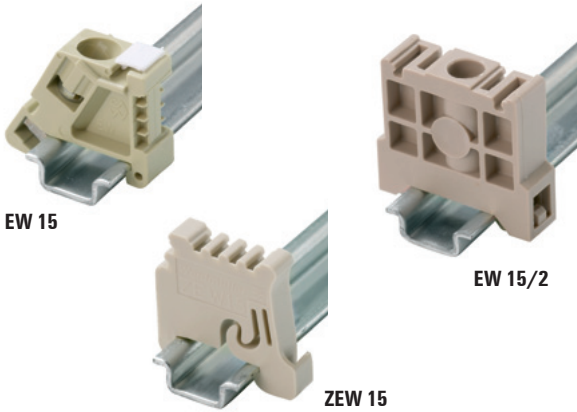

Polyamide 66, screw-in	Colour	Torque	Qty.	Order No.
EW 15	beige	0.4 Nm	50	0382860000

Polyamide with fiberglass, screw-in	Colour	Torque	Qty.	Order No.
EW 15/2	dark beige	0.4 Nm	50	1071900000

Polyamide 66, screwless	Colour	Torque	Qty.	Order No.
ZEW 15	beige		20	7920340000

For TS 32 terminal rail

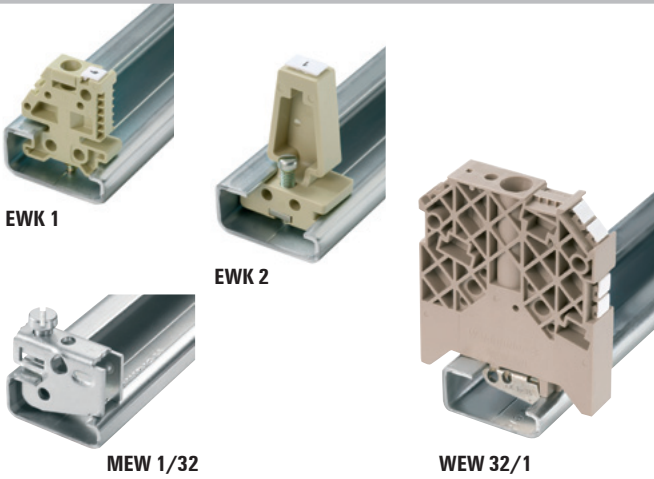

Polyamide 66, screw-in	Colour	Torque	Qty.	Order No.
EWK 2	beige	1.2 Nm	50	0199360000
EWK 1	beige	1.2 Nm	50	0206160000

Polyamide with fiberglass, screw-in	Colour	Torque	Qty.	Order No.
WEW 32/1	dark beige	0.5 Nm	50	1067600000

Metal, screw-in	Colour	Torque	Qty.	Order No.
MEW 1/32	silver	2 Nm	20	0445600000

For TS 35 terminal rail

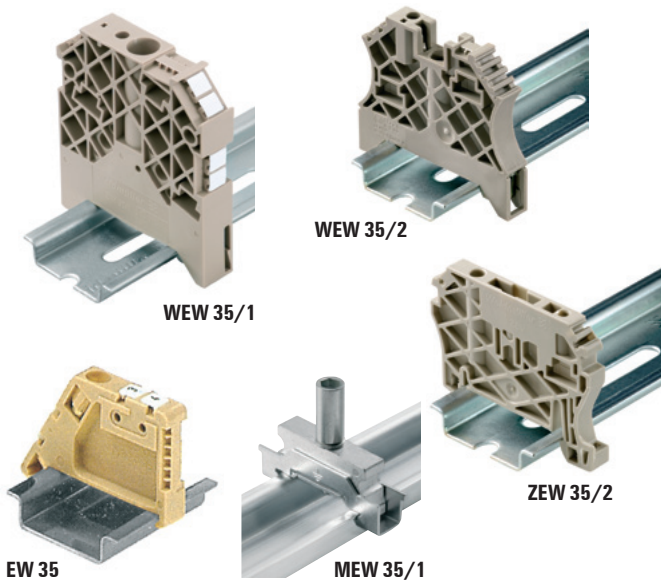

Polyamide with fiberglass, screw-in	Colour	Torque	Qty.	Order No.
WEW 35/1	dark beige	1.2 Nm	50	1059000000
WEW-35/2	dark beige	0.5 Nm	100	1061200000
WEW 35/1 GR	grey	1.2 Nm	50	1227890000
WEW 35/1 SW	black	1.2 Nm	50	1162600000
WEW 35/2 GR	grey	0.5 Nm	100	1859200000
WEW 35/3 SW	black	0.5 Nm	100	1061210000

Polyamide 66, screwless	Colour	Torque	Qty.	Order No.
ZEW (6 mm)	beige		20	9540000000
ZEW 35/2 (8 mm)	beige		20	8630740000
ZEW 35 GR	grey		20	1238040000
ZEW 35/2 GR	grey		20	1227850000
ZEW 35/2 SW	black		20	1162610000

Polyamide 66, screw-in	Colour	Torque	Qty.	Order No.
EW 35	beige	0.5 Nm	50	0383560000
EW 35 GR	grey	0.5 Nm	50	0383530000
EW 35 DB (V0)	dark beige		50	1269050000
	silver	5.5 Nm	10	1805610000

Metal, screwable	Colour	Torque	Qty.	Order No.
MEW 35/1	silver	5.5 Nm	10	1805610000

Terminal rail supports



TSTW 5/M5



TSTW 5/M5 galvanised



TSTW 6/M6



TST

	Thread	Qty.	Order No.
TSTW 5/M5	M5	10	0178100000
TSTW 5/M5 galvanised	M5	10	1779100000
TSTW 6/M6	M6	10	0164000000

Terminal rail supports of type **TSTW** are used for angled fixing of terminal rails at an angle of 35°.

TST 2/M5	M5	10	1286600000
TST 2/M6	M6	10	0101700000

The **TST** terminal rail support is used for assembly of terminal rails in a frame or over a cut-out

Fixing screws

FKSC M5x8 Ø9	50	0295900000
FKSC M6x8 Ø9	50	0642600000
FKSC M6x12 Ø9	50	0353500000

Weidmüller supplies fixing screws with hexagonal sockets and a very low head for the terminal rail supports so that the terminals can also be fitted over the screw.

Mounting feet



FM 4

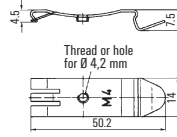

FM 5, FM 6 and FM 4.2: similar to illustrations



MOFU 35/L0/1

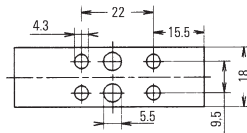

MOFU 35

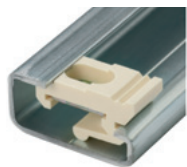
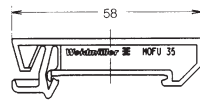

MB

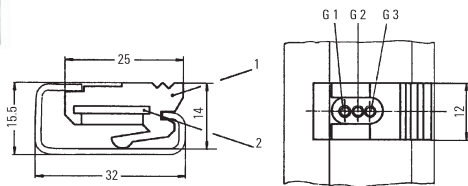

Clip-on foot, steel for TS 35	Thread	Qty.	Order No.
FM 4	M4	40	0687900000
FM 5	M5	40	0636800000
FM 6	M6	40	0636900000
FM 4.2	Hole \varnothing 4.2 mm	40	1724580000

Mounting foot, PA orange for TS 35			
MOFU 35/L0/1	with holes	20	0646260000
MOFU 35		20	0495660000
MOFU 35/L0/1	black	20	0646210000

Sliding nut for TS 32		Colour	Qty.	Order No.
MB M3/M5	M3 and M5	creme	20	0503500000
MB M5/M3	M5 and M3	black	20	0553400000
MB M6/M4	M6 and M4	grey	20	0334900000

The sliding nut for the RS 32 terminal rail has two threaded holes for screws M3 + M5 / M6 + M4 / M5 + M3.

It is used to fasten components which cannot be slotted directly onto the TS 32, in particular the smaller TS 15 top hat rail.

This enables, for example, mini-terminals to be snapped onto the TS 15 first, and this rail is then fastened together with the terminals to the TS 32 using the sliding nut.

Several German safety regulations, e.g. VBG 4 and VDE 0106 part 100, call for the active parts of electrical equipment to be protected against direct contact.

For this purpose, Weidmüller can supply cover strips and associated retaining plates which can be used for the common sizes of terminal. Retaining plates are fitted at the ends of a terminal strip but can also be inserted between terminals. They are suitable for mounting on TS 32, TS 35 or TS 15 terminal rails.

Spacing of retaining plates:
The distance between the retaining plates for the ADP 1, 2 and 3 cover strips should not exceed 300 mm.

The cover strip is clipped into lugs at the sides, but can also be fixed to spigots on the retaining plates which can be provided with a lead seal.

The cover strips are transparent so that terminals with accessories and markings can be identified at any time. Additional markings, e.g. groups, can be attached to the cover strips.

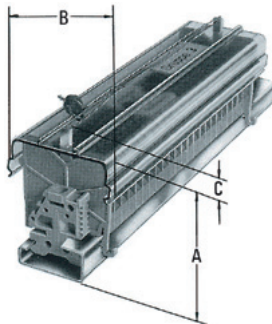

ADP

Cover strips



Material: unplasticised PVC
Supplied in 1 m lengths
Temperature limit: max. 70 °C

transparent Type	Order No.
ADP 1 	0485200000
ADP 2 	0485300000
ADP 3 	0485400000
ADP 4 (1000 mm) 	1430760000
grey Type	Order No.
ADP 4 (300 mm) 	1378160000
TSK 31.5 	0347960000

HP

Retaining plates

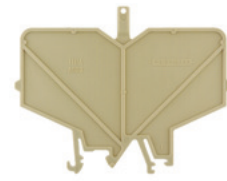

Material: PA 66
Thickness: 2 mm

For mounting on TS 35 / TS 32, with spigot for lead seal	
Type	Order No.
HP 1 	0485560000
HP 2 	0485660000
HP 3 	0485760000
HP 4 	0485860000
For mounting on TS 15	
Type	Order No.
HP 7 	0258260000
HP 8 	0258360000

Covers

Overall dimensions	A	A	A	A	B	C
for mounting on terminal rails	TS 32	TS 35 x 7.5	TS 35 x 15	TS 15		
ADP 1, HP 1	61	56	63		49	6
ADP 2, HP 2	77	72	79		62.5	6
ADP 3, HP 3	94	89	86		92	6
ADP 3, HP 4	73.5	68.5	75.5		92	6
ADP 1, HP 8				45	49	6
TSK 31.5, HP 7				35	31	6
Marking materials	Type	Qty.	Order No.			
Card with warning "lightning flash", self adhesive 20 pcs. per card	BEZ-KARTE ADP	10	0566700000			

Terminal markers

Weidmüller's multitude of different terminal markers enable users to solve virtually every labelling task for all types of wire and cable connectors. Whether multi-character labelling, ready-to-use markers with standard printing or individual, custom markers, whether white or coloured or group designations at terminals, the comprehensive range of Weidmüller products solves every marking task simply, quickly and clearly.

The tables on the following pages show which markers fit the various terminal series. The terminal pitch governs the selection of a marker. For example, a WDU 2.5 terminal has a pitch of 5 mm, the WS 12/5 marker is 12 mm long and suitable for a 5 mm pitch.

Whole blocks of terminals can be marked as a strip using the Weidmüller system. When a terminal with a larger pitch has to be marked (e.g. WDU 16), a smaller marker (e.g. WS 12/5) can be clipped onto it. Most of the markers are compatible with each other.

The two traditional marker series, DEK and WS, are available as ready-to-use markers. And these markers are also available in the MultiCard format for printing by users themselves.

MultiCards can be printed on with the innovative PrintJet, Smark Laser, Plotter MCP Plus or MC-Mobilo printing systems, using M-Print PRO® software.

To see a small selection of the Weidmüller markers, order our bag of samples, order No. **1646670000**.

Owing to the sheer number of possible applications and environmental influences such as moisture, radiation, gases or heat/cold to which the products can be exposed, Weidmüller accepts no liability for the suitability of products in all customer applications. Suitability tests for specific applications must therefore be carried out by the customer. However, Weidmüller will be happy to provide help and advice upon request.

W series

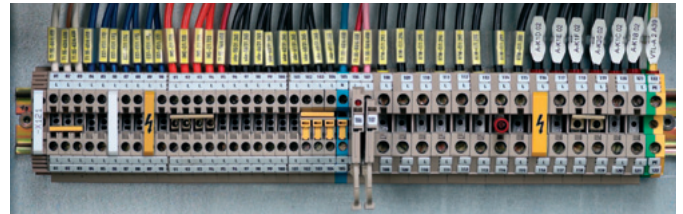

Z series

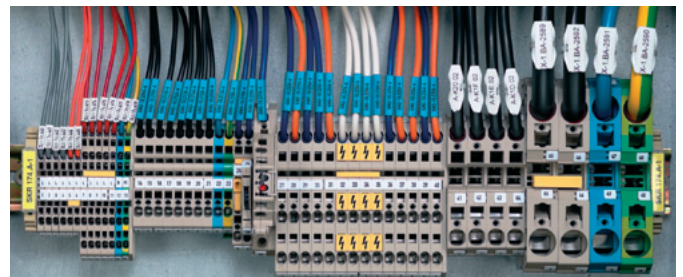

I series

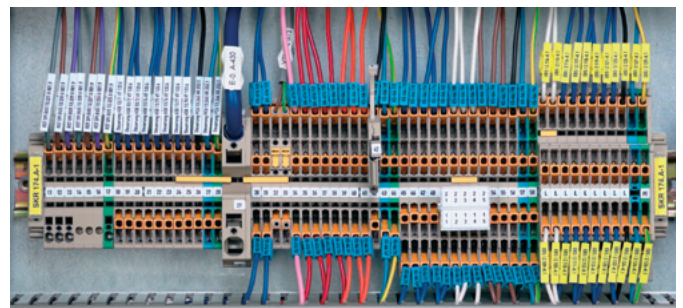

P series



Due to the different identification systems available on the market, we wish to point out that Weidmüller does not guarantee industrial identification products if the Weidmüller components (markers – transparent sleeves – ink/toner/colour ink ribbons – printing systems) are combined with third-party products, unless Weidmüller has explicitly agreed for the purpose of an individual application.

Selection table

Designation	Terminal width	DEK	WS	ZS	Scht 7	Scht 9/4	Scht 14/6	WTS 3/4	WGB 5/ WAD 5	WGB 8/ WAD 8	WAD 12	WAD 27	ZGB 15/ ZGB 30	BZT 1	BZT 2	EM 8/30	Other
ADK 1	6	6	-	-	-	-	-	-	-	-	-	-	-	-	-	-	-
AKA 4	6	6	-	-	-	-	-	-	-	-	-	-	-	-	-	-	-
AKE 2.5/AKZ 2.5...	5	5	-	-	-	-	-	-	-	-	-	-	-	-	-	-	-
AKE 2.5	5.1	5	-	-	-	-	-	-	-	-	-	-	-	-	-	-	-
AKE 4	7	6.5	-	-	-	-	-	-	-	-	-	-	-	-	-	-	-
AKZ 1.5...	5	5	-	-	-	-	-	-	-	-	-	-	-	-	-	-	-
AKZ 1.5-2.5	5.1	5	-	-	-	-	-	-	-	-	-	-	-	-	-	-	-
AKZ 4	6.1	6	-	-	-	-	-	-	-	-	-	-	-	-	-	-	-
AKZ 4.../AKB 4...	6	6	8/5	-	-	x	-	-	-	-	-	-	-	-	-	-	-
AL 1	6.5	6.5	-	-	-	-	-	-	-	-	-	-	-	-	-	-	-
ASK 1	8	8	-	-	x	-	-	-	-	-	-	-	-	-	-	-	-
AST 1-4/35	6.2	6	-	-	-	-	-	-	-	-	-	-	-	-	-	-	-
AST 5/35	6.5	6	-	-	-	-	-	-	-	-	-	-	-	-	-	-	-
BZT ZVL 1.5	5.08	5	12/5	-	-	-	-	-	-	-	-	-	-	-	-	-	-
DK 4...	6	6	-	-	-	-	-	-	-	-	-	-	-	-	-	-	-
DKT 4...	6	6	-	-	-	-	-	-	-	-	-	-	-	-	-	-	-
DLA 2.5...	6	6	8/5	-	x	x	x	-	-	-	-	-	-	-	-	-	-
DLD 2.5...	6	6	8/5	-	x	x	x	-	-	-	-	-	-	-	-	-	-
DLI 2.5	6	6	8/5	-	x	x	x	-	-	-	-	-	-	-	-	-	-
EK 10	10	5	-	-	-	-	-	-	-	-	-	-	-	-	-	-	-
EK 16	12	5	-	-	-	-	-	-	-	-	-	-	-	-	-	-	-
EK 2.5...	6	6	-	-	-	-	-	-	-	-	-	-	-	-	-	-	-
EK 35...	16	5	-	-	-	-	-	-	-	-	-	-	-	-	-	-	-
EK 4...	6.5	6.5	-	-	-	-	-	-	-	-	-	-	-	-	-	-	-
EK 6/35	8	8	-	-	-	-	-	-	-	-	-	-	-	-	-	-	-
EW 15	9.5	5	12/5	-	x	x	-	x	-	-	-	-	-	-	-	-	-
EW 15/2	8	5	-	-	-	-	-	-	-	-	-	-	-	-	-	-	-
EW 35	8.5	5	8/5	-	-	-	-	x	-	-	-	-	-	-	-	-	-
EWK	8.5	5	8/5	-	-	-	-	-	-	-	-	-	-	-	-	-	-
EWK 1	8.5	5	8/5	-	-	-	-	x	-	-	-	-	-	-	-	-	-
EWK 2	8.5	5	8/5	-	-	-	-	-	-	-	-	-	-	-	-	-	-
IAK 1.5N 3L	5	5	10/5 ²⁾	10/5	-	-	-	-	-	-	-	-	x	-	-	-	-
IDK 1.5N	5	5	10/5 ²⁾	10/5	-	x ³⁾	-	-	-	-	-	-	-	-	-	-	-
IDK 1.5N/V	5	5	10/5 ²⁾	10/5	-	-	-	-	-	-	-	-	x	-	-	-	-
IDU 1.5 N ...	5	5	10/5 ²⁾	10/5	-	-	-	-	-	-	-	-	x	-	-	-	-
IEK 1.5N...	5	5	10/5 ²⁾	10/5	-	-	-	-	-	-	-	-	x	-	-	-	-
IHK 1.5N...	5	5	10/5 ²⁾	10/5	-	-	-	-	-	-	-	-	x	-	-	-	-
IPE 1.5N...	5	5	10/5 ²⁾	10/5	-	-	-	-	-	-	-	-	x	-	-	-	-
ITR 1.5N...	5	5	10/5 ²⁾	10/5	-	-	-	-	-	-	-	-	x	-	-	-	-
KDKS 1...	8	8	-	-	-	-	-	-	-	-	-	-	-	-	-	-	-
KMVF...	6	5	-	-	-	-	-	-	-	-	-	-	-	-	-	-	-
KSKM...	13	5	-	-	-	-	-	-	-	-	-	-	-	-	-	-	-
KST...	24-34	5	-	-	-	-	-	-	-	-	-	-	-	-	-	-	-
MAK 2.5/VLI 1.5...	6	6	8/5	-	x	x	x	-	-	-	-	-	x	-	-	-	-
NT...	6-12	6	-	-	-	-	-	-	-	-	-	-	-	-	-	-	-
PDK 2.5/4	5	5	12/5	-	-	-	-	-	-	-	-	-	-	-	-	-	-
PDL 4...	5	5	12/5	-	-	-	-	-	-	-	-	-	-	-	-	-	-
PDU 16	12	-	10/12	-	-	-	-	-	-	-	-	-	-	-	-	-	-
PDU 2.5/4...	5	5	12/5	-	-	-	-	-	-	-	-	-	-	-	-	-	-
PDU 6/10...	8	8	10/8	-	-	-	-	-	-	-	-	-	-	-	-	-	-
PEI 16	12	-	10/12	-	-	-	-	-	-	-	-	-	-	-	-	-	-
PNT 16	12	-	10/12	-	-	-	-	-	-	-	-	-	-	-	-	-	-
PNT 2.5/4	5	5	12/5	-	-	-	-	-	-	-	-	-	-	-	-	-	-
PNT 6/10	8	8	10/8	-	-	-	-	-	-	-	-	-	-	-	-	-	-
PPE 16	12	-	10/12	-	-	-	-	-	-	-	-	-	-	-	-	-	-
PPE 2.5/4	5	5	12/5	-	-	-	-	-	-	-	-	-	-	-	-	-	-
PPE 6/10	8	8	10/8	-	-	-	-	-	-	-	-	-	-	-	-	-	-
PTR 2.5/4...	5.1	5/5	10/5	-	-	-	-	-	-	-	-	-	-	-	-	-	-
RSF 1-3...	8	5	-	-	-	-	-	-	-	-	-	-	-	-	-	-	-
SAK 10...	10	5	-	-	-	-	-	-	-	-	-	-	-	-	-	-	-
SAK 16...	12	5	-	-	-	-	-	-	-	-	-	-	-	-	-	-	-
SAK 2.5	6.1	6	-	-	x	-	-	-	-	-	-	-	-	-	-	-	-
SAK 2.5/35	5	5	-	-	x	-	-	-	-	-	-	-	-	-	-	-	-
SAK 35...	18	5	-	-	x	-	-	-	-	-	-	-	-	-	-	-	-
SAK 4...	6.5	6.5	-	-	x	-	-	-	-	-	-	-	-	-	-	-	-
SAK 6...	8	8	-	-	x	-	-	-	-	-	-	-	-	-	-	-	-
SAK 95/35	28	5	-	-	x	-	-	-	-	-	-	-	-	-	-	-	-
SAKA 10	12	5	-	-	x	-	-	-	-	-	-	-	-	-	-	-	-
SAKB 10	10	5	-	-	x	-	-	-	-	-	-	-	-	-	-	-	-
SAKC 10/35	12	6.5	-	-	x	-	-	-	-	-	-	-	-	-	-	-	-
SAKC 4/35	6.5	6.5	-	-	x	-	-	-	-	-	-	-	-	-	-	-	-
SAKD 2.5N	5	5	-	-	x	-	-	-	-	-	-	-	-	-	-	-	-
SAKG...	32-54	5	-	-	x	-	-	-	-	-	-	-	-	-	-	-	-
SAKH 35	18	6.5	-	-	-	-	-	-	-	-	-	-	-	-	-	-	-
SAKH 4-10	6.5-14	5	-	-	x	-	-	-	-	-	-	-	-	-	-	-	-
SAKK 10..	11.5	5	-	-	x	-	-	-	-	-	-	-	-	-	-	-	-
SAKK 4..	8	6.5	-	-	x	-	-	-	-	-	-	-	-	-	-	-	-
SAKR...	6.5	6.5	-	-	x	-	-	-	-	-	-	-	-	-	-	-	-
SAKS...	13-28	5	-	-	x	-	-	-	-	-	-	-	-	-	-	-	-
SAKT...	8	6.5	-	-	x	-	-	-	-	-	-	-	-	-	-	-	-
VWVG 4...	10	5/5	12/6.5	-	-	-	-	-	-	-	-	-	-	-	-	-	-
VWVG 6...	10	5/5	12/6.5	-	-	-	-	-	-	-	-	-	-	-	-	-	-

1) = WS 10/6 Middle; 2) = WS 10/5 Middle; 3) = SnapMark

Terminal markers - Selection table

Accessories

F

Designation	Terminal width	DEK	WS	Zs	SchT 7	SchT 9/4	SchT 14/6	WTS 3/4	WGB 5/ WAD 5	WGB 8/ WAD 8	WAD 12	WAD 27	ZGB 15/ ZGB 30	BZT 1	BZT 2	EM 8/30	Other
WDK 1.5/R 3.5...	3.5	3.5	-	-	-	-	-	-	-	-	-	-	-	-	-	-	-
WDK 2.5 ...	5	5	8/5	-	-	x	-	-	-	-	-	-	x	-	-	-	-
WDK 2.5 800V	6	6	8/5	-	-	x	-	-	-	-	-	-	x	-	-	-	-
WDK 2.5/BLA R5.08	5.08	5	8/5	-	-	-	-	x	-	-	-	-	-	-	-	-	-
WDK 2.5/BLZ R5.08	5.08	5	8/5	-	-	-	-	x	-	-	-	-	-	-	-	-	-
WDK 2.5N...	5	5	8/5	-	-	-	-	-	-	-	-	-	-	-	-	-	-
WDK 4N...	5	5	8/5	-	-	-	-	-	-	-	-	-	-	-	-	-	-
WDL 2.5/...	6	6	8/5	-	-	-	-	x	-	-	-	-	x	-	-	-	-
WDT 1.5	6.5	6.5	8/5	-	-	-	-	-	-	-	-	-	-	-	-	-	-
WDTR 2.5...	6.2	6	8/5	-	-	x	-	-	-	-	-	-	-	-	-	-	-
WDU (WPE) 120/150	32	5	10/5	-	-	-	-	x	-	-	-	x	-	-	-	-	-
WDU (WPE) 35 N	16	5	12/5	-	x	x	x	x	-	-	-	-	x	-	-	-	-
WDU (WPE) 70/95	27	5	12/5	-	-	-	-	x	-	-	-	x	-	-	-	-	-
WDU (WPE) 70N	20.5	5	12/5	-	x	x	x	x	-	-	-	-	x	-	-	-	-
WDU 1.5 LD/BLA	5.08	5	12/5	-	x	x	x	x	-	-	-	-	x	-	-	-	-
WDU 1.5/BLA	5.08	5	12/5	-	x	x	x	x	-	-	-	-	x	-	-	-	-
WDU 1.5/BLZ R7.62	7.62	5	-	-	-	-	-	-	-	-	-	-	x	-	-	-	-
WDU 1.5/BLZ/5.08	5.08	5	12/5	-	x	x	x	x	-	-	-	-	x	-	-	-	-
WDU 1.5/BLZ/LD/5.08	5.08	5	12/5	-	x	x	x	x	-	-	-	-	x	-	-	-	-
WDU 1.5/R 3.5...	3.5	3.5	-	-	-	-	-	-	-	-	-	-	-	-	-	-	-
WDU 1.5/R/BLA	5.08	5	12/5	-	x	x	x	x	-	-	-	-	x	-	-	-	-
WDU 1.5/ZZ	5	5	12/5	-	x	x	x	x	-	-	-	-	x	-	-	-	-
WDU 10 SL	10	5	12/5	-	x	x	x	x	x	x	-	-	x	-	-	-	-
WDU 10...	10	5	12/5	-	x	x	x	x	x	x	-	-	x	-	-	-	-
WDU 16 (/ZA)	12	5	12/5	-	x	x	x	x	-	-	x	-	x	-	-	-	-
WDU 16 N	12	5	12/5	-	x	x	x	x	-	-	-	-	x	-	-	-	-
WDU 2.5 F	5	5	12/5	-	-	-	-	x	-	-	-	-	-	-	-	-	-
WDU 2.5 FF	5	5	12/5	-	x	-	-	x	-	-	-	-	-	-	-	-	-
WDU 2.5 N (WDU 1.5)	5	5	12/5	-	x	x	x	x	-	-	-	-	x	-	-	-	-
WDU 2.5 TC...	5	5	12/5	-	x	x	-	x	-	-	-	-	x	-	-	-	-
WDU 2.5...	5	5	12/5	-	x	x	x	x	x	-	-	-	x	-	-	-	-
WDU 2.5/1.5/ZZ	5	5	12/5	-	x	x	x	x	-	-	-	-	x	-	-	-	-
WDU 2.5/BLZ R7.62	7.62	5	-	-	-	-	-	-	-	-	-	-	x	-	-	-	-
WDU 240...	36	5	12/5	-	-	-	-	-	-	-	-	-	-	-	-	-	-
WDU 35	16	5	12/5	-	x	x	x	x	-	-	x	-	x	-	-	-	-
WDU 4 ...	6	6	12/6	-	x	x	x	x	x	-	-	-	x	-	-	-	-
WDU 4N ...	6	6	12/6	-	x	x	x	x	-	-	-	-	x	-	-	-	-
WDU 50N	18.5	5	12/5	-	-	-	-	-	-	-	-	-	-	-	-	-	-
WDU 6 ...	8	8	12/8	-	x	x	x	x	x	x	-	-	x	-	-	-	-
WDU 95N	27	8	15/5	-	-	-	-	-	-	-	-	-	-	-	-	-	-
WDUL 4	6	6	12/6	-	x	x	x	x	x	-	-	-	x	-	-	-	-
WEW 32/1	12.2	5	12/5	-	x	x	x	x	-	-	-	x	x	-	-	-	-
WEW 35/1	12.2	5	12/5	-	x	x	x	x	-	-	-	-	-	-	-	-	-
WEW 35/2	8	8	12/5	-	x	x	x	x	x	x	-	-	-	-	-	x	-
WF 10...	35.6	6	15/5	-	-	-	-	-	-	-	-	-	-	-	-	-	-
WF 12...	35.6	6	15/5	-	-	-	-	-	-	-	-	-	-	-	-	-	-
WF 5...	13	6	15/5	-	-	-	-	-	-	-	-	-	-	-	-	-	-
WF 6...	19.6	6	15/5	-	-	-	-	-	-	-	-	-	-	-	-	-	-
WF 8...	24.6	6	15/5	-	-	-	-	-	-	-	-	-	-	-	-	-	-
WFF 120...	42	5	12/6.5	-	-	-	-	-	-	-	-	-	-	-	-	-	-
WFF 185...	55	5	12/6.5	-	-	-	-	-	-	-	-	-	-	-	-	-	-
WFF 300...	55	5	12/6.5	-	-	-	-	-	-	-	-	-	-	-	-	-	-
WFF 35...	27	5	12/5	-	-	-	-	-	-	-	-	-	-	-	-	-	-
WFF 70...	32	5	12/6.5	-	-	-	-	-	-	-	-	-	-	-	-	-	-
WGK 10.../WGKV 10...	10.1	5/5	12/6.5	-	-	-	-	-	-	-	-	-	-	-	-	-	-
WGK 16...	12.1	5/5	12/6.5	-	-	-	-	-	-	-	-	-	-	-	-	-	-
WGK 25.../WGKV 25...	15.1	5/5	12/6.5	-	-	-	-	-	-	-	-	-	-	-	-	-	-
WGK 4.../WGKV 4...	8.1	5/8	10/8	-	-	-	-	-	-	-	-	-	-	-	-	-	-
WGK 50...	18.8	6/5	-	-	-	-	-	-	-	-	-	-	-	-	-	-	-
WGK 95...	25	5/8	-	-	-	-	-	-	-	-	-	-	-	-	-	-	-
WMA 4...	6	6	12/6	-	x	x	x	x	x	-	-	-	x	-	-	-	-
WNT 10	10	5	12/5	-	x	x	x	x	-	-	-	-	x	-	-	-	-
WNT 16 N	12	5	12/5	-	x	x	x	x	-	-	-	-	x	-	-	-	-
WNT 2.5	5	5	12/5	-	x	x	x	x	-	-	-	-	x	-	-	-	-
WNT 35 N	16	5	12/5	-	x	x	x	x	-	-	-	-	x	-	-	-	-
WNT 4	6	6	12/6	-	x	x	x	x	-	-	-	-	x	-	-	-	-
WNT 6	8	8	12/5	-	x	x	x	x	-	-	-	-	x	-	-	-	-
WNT 70 N	20.5	5	12/5	-	x	x	x	x	-	-	-	-	x	-	-	-	-
WPDB...																	LM MT3000 15x9 GE
WPE 1.5/R3.5	3.5	3.5	12/3.5	-	-	-	-	-	-	-	-	-	-	-	-	-	-
WPE 1.5/ZZ	5	5	12/5	-	x	x	x	x	-	-	-	-	x	-	-	-	-
WPE 10...	10	5	12/5	-	x	x	x	x	-	-	-	-	x	-	-	-	-
WPE 120	32	8	12/6.5	-	-	-	-	-	-	-	-	-	-	-	-	-	-
WPE 16	12	5	12/5	-	x	x	x	x	-	-	-	-	x	-	-	-	-
WPE 16 N	12	5	12/5	-	x	x	x	x	-	-	-	-	x	-	-	-	-
WPE 2.5 N (WPE 1.5)	5	5	12/5	-	x	x	x	x	-	-	-	-	x	-	-	-	-
WPE 2.5...	5	5	12/5	-	x	x	x	x	-	-	-	-	x	-	-	-	-
WPE 2.5/1.5/ZR	5	5	12/5	-	-	-	-	-	-	-	-	-	-	-	-	-	-
WPE 35...	16	5	12/5	-	x	x	x	x	-	-	-	-	x	-	-	-	-
WPE 4	6	6	12/6	-	x	x	x	x	-	-	-	-	x	-	-	-	-
WPE 4N	6	6	12/6	-	-	-	-	-	-	-	-	-	-	-	-	-	-

Designation	Terminal width	DEK	WS	ZS	SchT 7	SchT 9/4	SchT 14/6	WTS 3/4	WGB 5/ WAD 5	WGB 8/ WAD 8	WAD 12	WAD 27	ZGB 15/ ZGB 30	BZT 1	BZT 2	EM 8/30	Other
WPE 50N	18.5	8	12/6.5	-	-	-	-	-	-	-	-	-	-	-	-	-	-
WPE 6	8	8	12/5	-	x	x	x	x	-	-	-	-	x	-	-	-	-
WPE 95N/120N	27	8	15/5	-	-	-	-	-	-	-	-	-	-	-	-	-	-
WPO 4	6	6	10/6	-	-	-	-	-	-	-	-	-	x	-	-	-	-
WSI 25...	18	-	-	-	-	-	-	-	-	-	-	-	-	-	-	-	ESG 6/15
WSI 6...	8	8	12/5	-	-	-	-	x	-	-	-	-	x	-	-	-	-
WSI 6/2...	12	8	12/6.5	-	-	-	-	-	-	-	-	-	-	-	-	-	-
WTD 6/1	8	8	12/5	-	-	-	-	x	-	-	-	-	x	-	-	-	-
WTL 35	16	-	12/6	-	-	-	-	-	-	-	-	-	-	-	-	-	-
WTL 4 ...	6	6	12/6	-	-	-	-	-	-	-	-	-	-	-	-	-	-
WTL 6/1...	8	8	12/8	-	-	-	-	x	-	-	-	-	x	-	-	-	-
WTL 6/2	8	8	12/8	-	-	-	-	x	-	-	-	-	x	-	-	-	-
WTL 6/3...	8	8	12/8	-	-	-	-	x	-	-	-	-	x	-	-	-	-
WTQ 6/1	8	8	12/8	-	-	-	-	x	-	-	-	-	x	-	-	-	-
WTR 2.5 ...	5	5	12/5	-	-	-	-	x	-	-	-	-	x	-	-	-	-
WTR 35 E	32	-	12/6	-	-	-	-	-	-	-	-	-	-	-	-	-	-
WTR 4...	6	6	12/6	-	-	-	-	-	-	-	-	-	-	-	-	-	-
ZAP/TW ZIA 1.5/...	3.8	3.5	-	-	-	-	-	-	-	-	-	-	-	-	-	-	-
ZDK 1.5...	3.5	3.5	12/3.5	-	-	-	-	-	-	-	-	-	-	-	-	-	-
ZDK 2.5...	5	5	12/5	15/5	-	-	-	x	-	-	-	-	x	-	-	-	-
ZDK 2.5-2...	5	5	10/5	10/5	-	-	-	-	-	-	-	-	-	-	-	-	-
ZDK 2.5N...	5.1	5/5	10/5	-	-	-	-	-	-	-	-	-	-	-	-	-	ZAD 9/4
ZDK 4/S/...	6	6	-	12/6	-	-	-	x	-	-	-	-	x	-	-	-	-
ZDK 6/S/...	8	8	-	-	-	-	-	x	-	-	-	-	x	-	-	-	-
ZDKPE 2.5	5	5	10/5	10/5	-	-	-	-	-	-	-	-	-	-	-	-	-
ZDL 2.5/...	5	5	-	10/5	-	-	-	-	-	-	-	-	x	-	-	-	-
ZDLD 2.5-2...	5	5	-	10/5	-	-	-	-	-	-	-	-	x	-	-	-	-
ZDT 2.5 ...	5	5	10/5	10/5	-	-	-	-	-	-	-	-	-	-	-	-	-
ZDTPE 2.5...	5	5	10/5	10/5	-	-	-	-	-	-	-	-	-	-	-	-	-
ZDTR 2.5	5	5	12/5	15/5	-	-	-	x	-	-	-	-	x	-	-	-	-
ZDU (ZPE) 10	10	5	12/5	15/5	-	x	-	-	-	-	-	-	x	x	x	-	-
ZDU (ZPE) 10/S...	10	5	10/5	15/5	-	x	-	-	-	-	-	-	x	x	x	-	-
ZDU (ZPE) 16...	12	5	12/5	15/5	-	x	-	x	-	-	-	-	x	x	x	-	-
ZDU (ZPE) 16/S...	12	5	10/5	15/5	-	x	-	-	-	-	-	-	x	x	x	-	-
ZDU (ZPE) 2.5 ...	5	5	12/5	15/5	-	-	-	x	-	-	-	-	x	x	x	-	-
ZDU (ZPE) 2.5-2/...	5	5	12/5	15/5	-	-	-	x	-	-	-	-	x	-	-	-	-
ZDU (ZPE) 2.5N...	5.1	5/5	10/5	-	-	-	-	-	-	-	-	-	-	-	-	-	ZAD 9/4
ZDU (ZPE) 35...	16	5	12/5	15/5	-	-	-	x	-	-	-	-	x	x	x	-	-
ZDU (ZPE) 4...	6	6	12/6	12/6	-	-	-	x	-	-	-	-	x	x	x	-	-
ZDU (ZPE) 4-2...	6	6	12/6	12/6	-	-	-	-	-	-	-	-	-	-	-	-	-
ZDU (ZPE) 6...	8	8	12/8	15/5	-	-	-	x	-	-	-	-	x	x	x	-	-
ZDU (ZPE) 6-2...	8	8	12/8	12/6	-	-	-	-	-	-	-	-	-	-	-	-	-
ZDU 1.5...	3.5	3.5	12/3.5	-	-	-	-	-	-	-	-	-	-	x	x	-	-
ZDUA (ZPEA) 2.5-2	5	5	8/5	15/5	-	-	-	x	-	-	-	-	x	-	-	-	-
ZDUA 2.5-2N	5	5	10/5	10/5	-	-	-	-	-	-	-	-	-	-	-	-	-
ZDUB (ZPEB) 2.5-2/...	5	5	8/5	15/5	-	-	-	-	-	-	-	-	x	-	-	-	-
ZEI 16	16	5	12/5	15/5	-	-	-	x	-	-	-	-	x	-	-	-	-
ZEI 6	10	8	12/6	12/6	-	-	-	x	-	-	-	-	x	x	x	-	-
ZEW 35/2	8	8	-	-	-	-	-	-	-	-	-	-	-	-	-	x	-
ZIA 1.5 ...	5.08	5	8/5	15/5	-	-	-	x	-	-	-	-	x	-	-	-	-
ZMAK 2.5	5	5	10/5	15/5	-	-	-	-	-	-	-	-	x	-	-	-	-
ZNT 10/S	10	5	-	-	-	-	-	-	-	-	-	-	-	-	-	-	-
ZNT 16/S	12	5	-	-	-	-	-	-	-	-	-	-	-	-	-	-	-
ZNT 2.5/S	5	5	10/5	10/5	-	-	-	-	-	-	-	-	-	-	-	-	-
ZNT 4/S	6	6	10/6	12/6	-	-	-	-	-	-	-	-	-	-	-	-	-
ZNT 6/S	8	8	10/6	12/6	-	-	-	-	-	-	-	-	-	-	-	-	-
ZP 2.5...	5.1	5/5	10/5	10/5	-	-	-	-	-	-	-	-	-	-	-	-	-
ZPE 16-2/1 AN	12	8	12/6	12/6	-	-	-	-	-	-	-	-	-	-	-	-	-
ZPV 1.5	5.08	5	12/5	15/5	-	x	x	x	-	-	-	-	x	-	-	-	-
ZRV 1.5...	5	5	8/5	10/5	-	x	x	x	-	-	-	-	x	-	-	-	-
ZSI 2.5...	8	8	12/5	15/5	-	-	-	x	-	-	-	-	x	-	-	-	-
ZSI 2.5/2...	12	5	12/5	15/5	-	-	-	x	-	-	-	-	x	-	-	-	-
ZSI 6-2/FC	8	6	12/6	12/6	-	-	-	-	-	-	-	-	-	-	-	-	-
ZT 2.5 ...	5	5	10/5	10/5	-	-	-	-	-	-	-	-	-	-	-	-	-
ZTD 6	8	8	12/6.5	-	-	-	-	-	-	-	-	-	-	-	-	-	-
ZTL 6	8	8	12/6.5	-	-	-	-	-	-	-	-	-	-	-	-	-	-
ZTPE 2.5 ...	5	5	10/5	10/5	-	-	-	-	-	-	-	-	-	-	-	-	-
ZTR 2.5...	5	5	12/5	15/5	-	-	-	x	-	-	-	-	x	-	-	-	-
ZTR 2.5-2...	5	5	14/5	10/5	-	-	-	-	-	-	-	-	-	-	-	-	-

DEK card with printing

The Dekafix marker is the universal marker for terminals and plug-in connectors as well as electronic modules from the Weidmüller product range. Dekafix provides you with a wide range of standard printing options. The system is particularly suitable for short sequences of numbers and is also available with customer specific printing.

- In strips for fast installation
- Large selection of ready-to-use printed markers
- Excellent printing quality thanks to the MC Laser
- Available in 4 widths
- Custom printing also possible

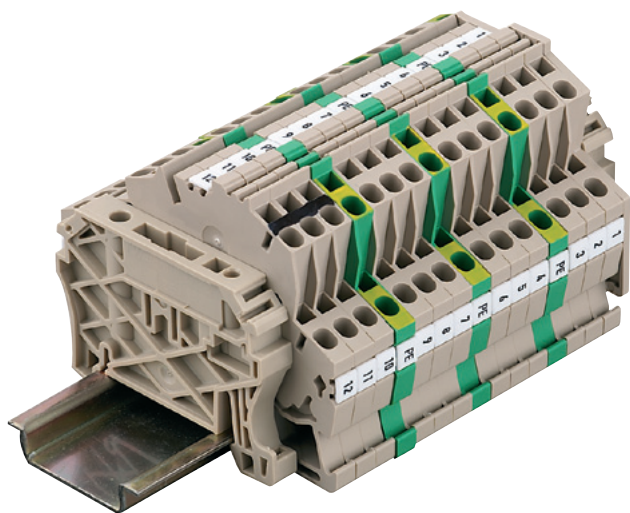
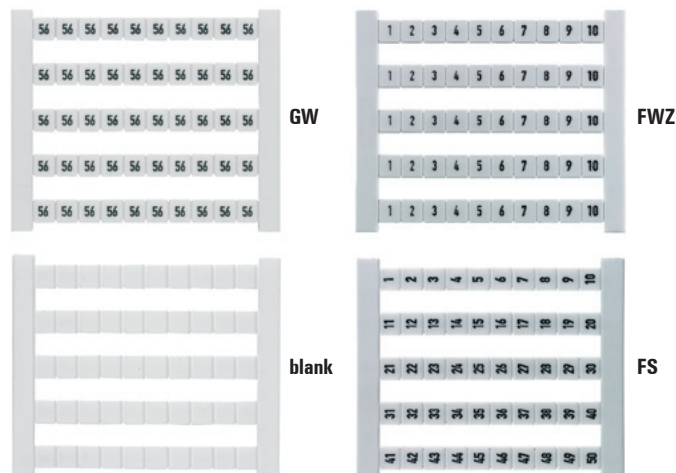

Technical data

Material	Polyamide 66, halogen-free
UL94 flammability rating	V2
Temperature range	-40 °C to 100 °C
Printing	black

Ordering data

Colour	Available in all colours of the international colour code; for MC on request			
	● brown	● red	● orange	
	● yellow	● green	● blue	
	● violet	● grey	○ white	
Qty.	500 pcs			
Pitch	DEK 5 = 5 mm : DEK 6 = 6 mm : DEK 6.5 = 6.5 mm : DEK 8 = 8 mm			
Printing variations	FW = consecutive horizontal	e.g. DEK 5 FW 1-50		
	FS = consecutive vertical	e.g. DEK 5 FS 51-100		
	FWZ = consecutive horizontal line	e.g. DEK 5 FWZ 1-10		
	FSZ = consecutive vertical line	e.g. DEK 5 FSZ 21-30		
	GW = identical horizontal	e.g. DEK 5 GW A		
	GS = identical vertical	e.g. DEK 5 GS B		
No. of characters	horizontal	vertical		
	Dek 5	max. 3 characters	max. 3 characters	
	Dek 6	max. 3 characters	max. 3 characters	
	Dek 6.5	max. 4 characters	max. 3 characters	
Dek 8	max. 5 characters	max. 3 characters		
Specifications for custom printing	Colour and print specifications			

Versions DEK

Type/Print	Order No.	Type/Print	Order No.	Type/Print	Order No.	Type/Print	Order No.
DEK 5 BL NEUTRAL	0473391693	DEK 5 FW X8-Z8	0133261157	DEK 5 GW 18	0522660018	DEK 5 GW 90	0522660090
DEK 5 BR NEUTRAL	0473391692	DEK 5 FW X9-Z9	0133261158	DEK 5 GW 19	0522660019	DEK 5 GW 91	0522660091
DEK 5 FS 1-50	0473560001	DEK 5 FWZ 1-10	0523060001	DEK 5 GW 20	0522660020	DEK 5 GW 92	0522660092
DEK 5 FS 101-150	0473560101	DEK 5 FWZ 1-19	0235860000	DEK 5 GW 21	0522660021	DEK 5 GW 93	0522660093
DEK 5 FS 151-200	0473560151	DEK 5 FWZ 1-9	1572000000	DEK 5 GW 22	0522660022	DEK 5 GW 94	0522660094
DEK 5 FS 201-250	0473560201	DEK 5 FWZ 11-20	0523060011	DEK 5 GW 23	0522660023	DEK 5 GW 95	0522660095
DEK 5 FS 251-300	0473560251	DEK 5 FWZ 2-20	0236160000	DEK 5 GW 24	0522660024	DEK 5 GW 96	0522660096
DEK 5 FS 301-350	0473560301	DEK 5 FWZ 21-30	0523060021	DEK 5 GW 25	0522660025	DEK 5 GW 97	0522660097
DEK 5 FS 351-400	0473560351	DEK 5 FWZ 21-39	0235960000	DEK 5 GW 26	0522660026	DEK 5 GW 98	0522660098
DEK 5 FS 401-450	0473560401	DEK 5 FWZ 22-40	0236260000	DEK 5 GW 27	0522660027	DEK 5 GW 99	0522660099
DEK 5 FS 451-500	0473560451	DEK 5 FWZ 31-40	0523060031	DEK 5 GW 28	0522660028	DEK 5 GW 100	0522660100
DEK 5 FS 501-550	0473560501	DEK 5 FWZ 41-50	0523060041	DEK 5 GW 29	0522660029	DEK 5 GW 101	0522660101
DEK 5 FS 51-100	0473560051	DEK 5 FWZ 41-59	0236060000	DEK 5 GW 30	0522660030	DEK 5 GW 102	0522660102
DEK 5 FS 551-600	0473560551	DEK 5 FWZ 42-60	0236360000	DEK 5 GW 31	0522660031	DEK 5 GW 103	0522660103
DEK 5 FS 601-650	0473560601	DEK 5 FWZ 51-60	0523060051	DEK 5 GW 32	0522660032	DEK 5 GW 104	0522660104
DEK 5 FS 651-700	0473560651	DEK 5 FWZ 61-70	0523060061	DEK 5 GW 33	0522660033	DEK 5 GW 105	0522660105
DEK 5 FS 701-750	0473560701	DEK 5 FWZ 71-80	0523060071	DEK 5 GW 34	0522660034	DEK 5 GW 106	0522660106
DEK 5 FS 751-800	0473560751	DEK 5 FWZ 81-90	0523060081	DEK 5 GW 35	0522660035	DEK 5 GW 107	0522660107
DEK 5 FS 801-850	0473560801	DEK 5 FWZ 91-100	0523060091	DEK 5 GW 36	0522660036	DEK 5 GW 108	0522660108
DEK 5 FS 851-900	0473560851	DEK 5 FWZ L1-EIK	0354361203	DEK 5 GW 37	0522660037	DEK 5 GW 109	0522660109
DEK 5 FS 901-950	0473560901	DEK 5 FWZ L1-PE	0354361187	DEK 5 GW 38	0522660038	DEK 5 GW 110	0522660110
DEK 5 FS 951-999	0473560951	DEK 5 FWZ U,V,W,N,PE	0558360000	DEK 5 GW 39	0522660039	DEK 5 GW 111	0522660111
DEK 5 FSZ 1-10	0460660001	DEK 5 GE NEUTRAL	0473391687	DEK 5 GW 40	0522660040	DEK 5 GW 112	0522660112
DEK 5 FSZ 11-20	0460660011	DEK 5 GN NEUTRAL	0473391688	DEK 5 GW 41	0522660041	DEK 5 GW 113	0522660113
DEK 5 FSZ 21-30	0460660021	DEK 5 GR NEUTRAL	0473391691	DEK 5 GW 42	0522660042	DEK 5 GW 114	0522660114
DEK 5 FSZ 31-40	0460660031	DEK 5 GS A	0132961021	DEK 5 GW 43	0522660043	DEK 5 GW 115	0522660115
DEK 5 FSZ 41-50	0460660041	DEK 5 GS B	0132961022	DEK 5 GW 44	0522660044	DEK 5 GW 116	0522660116
DEK 5 FSZ 51-60	0460660051	DEK 5 GS C	0132961023	DEK 5 GW 45	0522660045	DEK 5 GW 117	0522660117
DEK 5 FSZ 61-70	0460660061	DEK 5 GS D	0132961024	DEK 5 GW 46	0522660046	DEK 5 GW 118	0522660118
DEK 5 FSZ 71-80	0460660071	DEK 5 GS E	0132961025	DEK 5 GW 47	0522660047	DEK 5 GW 119	0522660119
DEK 5 FSZ 81-90	0460660081	DEK 5 GS F	0132961026	DEK 5 GW 48	0522660048	DEK 5 GW 120	0522660120
DEK 5 FSZ 91-100	0460660091	DEK 5 GS G	0132961027	DEK 5 GW 49	0522660049	DEK 5 GW 121	0522660121
DEK 5 FW 1,3,5,...99	1358460000	DEK 5 GS H	0132961028	DEK 5 GW 50	0522660050	DEK 5 GW 122	0522660122
DEK 5 FW 1-50	0473460001	DEK 5 GS I	0132961029	DEK 5 GW 51	0522660051	DEK 5 GW 123	0522660123
DEK 5 FW 10-500	0132660010	DEK 5 GS J	0132961030	DEK 5 GW 52	0522660052	DEK 5 GW 124	0522660124
DEK 5 FW 101-150	0473460101	DEK 5 GS K	0132961031	DEK 5 GW 53	0522660053	DEK 5 GW 125	0522660125
DEK 5 FW 151-200	0473460151	DEK 5 GS L	0132961032	DEK 5 GW 54	0522660054	DEK 5 GW 126	0522660126
DEK 5 FW 2,4,...100	1358560000	DEK 5 GS M	0132961033	DEK 5 GW 55	0522660055	DEK 5 GW 127	0522660127
DEK 5 FW 201-250	0473460201	DEK 5 GS N	0132961034	DEK 5 GW 56	0522660056	DEK 5 GW 128	0522660128
DEK 5 FW 251-300	0473460251	DEK 5 GS O	0132961035	DEK 5 GW 57	0522660057	DEK 5 GW 129	0522660129
DEK 5 FW 301-350	0473460301	DEK 5 GS P	0132961036	DEK 5 GW 58	0522660058	DEK 5 GW 130	0522660130
DEK 5 FW 351-400	0473460351	DEK 5 GS PE	0157261187	DEK 5 GW 59	0522660059	DEK 5 GW 131	0522660131
DEK 5 FW 401-450	0473460401	DEK 5 GS Q	0132961037	DEK 5 GW 60	0522660060	DEK 5 GW 132	0522660132
DEK 5 FW 451-500	0473460451	DEK 5 GS R	0132961038	DEK 5 GW 61	0522660061	DEK 5 GW 133	0522660133
DEK 5 FW 501-550	0473460501	DEK 5 GS S	0132961039	DEK 5 GW 62	0522660062	DEK 5 GW 134	0522660134
DEK 5 FW 51-100	0473460051	DEK 5 GS T	0132961040	DEK 5 GW 63	0522660063	DEK 5 GW 135	0522660135
DEK 5 FW 551-600	0473460551	DEK 5 GS U	0132961041	DEK 5 GW 64	0522660064	DEK 5 GW 136	0522660136
DEK 5 FW 601-650	0473460601	DEK 5 GS V	0132961042	DEK 5 GW 65	0522660065	DEK 5 GW 137	0522660137
DEK 5 FW 651-700	0473460651	DEK 5 GS W	0132961043	DEK 5 GW 66	0522660066	DEK 5 GW 138	0522660138
DEK 5 FW 701-750	0473460701	DEK 5 GS X	0132961044	DEK 5 GW 67	0522660067	DEK 5 GW 139	0522660139
DEK 5 FW 751-800	0473460751	DEK 5 GS Y	0132961045	DEK 5 GW 68	0522660068	DEK 5 GW 140	0522660140
DEK 5 FW 801-850	0473460801	DEK 5 GS Z	0132961046	DEK 5 GW 69	0522660069	DEK 5 GW 141	0522660141
DEK 5 FW 851-900	0473460851	DEK 5 GS g	0157261202	DEK 5 GW 70	0522660070	DEK 5 GW 142	0522660142
DEK 5 FW 901-950	0473460901	DEK 5 GS h	0157261203	DEK 5 GW 71	0522660071	DEK 5 GW 143	0522660143
DEK 5 FW 951-999	0473460951	DEK 5 GW	0576260000	DEK 5 GW 72	0522660072	DEK 5 GW 144	0522660144
DEK 5 FW U1-PE1	0133161114	DEK 5 GW 1	0522660001	DEK 5 GW 73	0522660073	DEK 5 GW 145	0522660145
DEK 5 FW U2-PE2	0133161115	DEK 5 GW 2	0522660002	DEK 5 GW 74	0522660074	DEK 5 GW 146	0522660146
DEK 5 FW U3-PE3	0133161116	DEK 5 GW 3	0522660003	DEK 5 GW 75	0522660075	DEK 5 GW 147	0522660147
DEK 5 FW U4-PE4	0133161117	DEK 5 GW 4	0522660004	DEK 5 GW 76	0522660076	DEK 5 GW 148	0522660148
DEK 5 FW U5-PE5	0133161118	DEK 5 GW 5	0522660005	DEK 5 GW 77	0522660077	DEK 5 GW 149	0522660149
DEK 5 FW U6-PE6	0133161119	DEK 5 GW 6	0522660006	DEK 5 GW 78	0522660078	DEK 5 GW 150	0522660150
DEK 5 FW U7-PE7	0133161120	DEK 5 GW 7	0522660007	DEK 5 GW 79	0522660079	DEK 5 GW 151	0522660151
DEK 5 FW U8-PE8	0133161121	DEK 5 GW 8	0522660008	DEK 5 GW 80	0522660080	DEK 5 GW 152	0522660152
DEK 5 FW U9-PE9	0133161122	DEK 5 GW 9	0522660009	DEK 5 GW 81	0522660081	DEK 5 GW 153	0522660153
DEK 5 FW X1-Z1	0133261150	DEK 5 GW 10	0522660010	DEK 5 GW 82	0522660082	DEK 5 GW 154	0522660154
DEK 5 FW X10-Z10	0133261159	DEK 5 GW 11	0522660011	DEK 5 GW 83	0522660083	DEK 5 GW 155	0522660155
DEK 5 FW X2-Z2	0133261151	DEK 5 GW 12	0522660012	DEK 5 GW 84	0522660084	DEK 5 GW 156	0522660156
DEK 5 FW X3-Z3	0133261152	DEK 5 GW 13	0522660013	DEK 5 GW 85	0522660085	DEK 5 GW 157	0522660157
DEK 5 FW X4-Z4	0133261153	DEK 5 GW 14	0522660014	DEK 5 GW 86	0522660086	DEK 5 GW 158	0522660158
DEK 5 FW X5-Z5	0133261154	DEK 5 GW 15	0522660015	DEK 5 GW 87	0522660087	DEK 5 GW 159	0522660159
DEK 5 FW X6-Z6	0133261155	DEK 5 GW 16	0522660016	DEK 5 GW 88	0522660088	DEK 5 GW 160	0522660160
DEK 5 FW X7-Z7	0133261156	DEK 5 GW 17	0522660017	DEK 5 GW 89	0522660089	DEK 5 GW 161	0522660161

Versions DEK

Type/Print	Order No.	Type/Print	Order No.	Type/Print	Order No.	Type/Print	Order No.
DEK 5 GW 162	0522660162	DEK 5 GW Y	0522761045	DEK 6 FW 1-50	0468660001	DEK 6 GW 23	0526960023
DEK 5 GW 163	0522660163	DEK 5 GW Z	0522761046	DEK 6 FW 101-150	0468660101	DEK 6 GW 24	0526960024
DEK 5 GW 164	0522660164	DEK 5 GW +	0576261198	DEK 6 FW 151-200	0468660151	DEK 6 GW 25	0526960025
DEK 5 GW 165	0522660165	DEK 5 GW -	0576261199	DEK 6 FW 2,4,...100	1358760000	DEK 6 GW 26	0526960026
DEK 5 GW 166	0522660166	DEK 5 GW g	0576261202	DEK 6 FW 201-250	0468660201	DEK 6 GW 27	0526960027
DEK 5 GW 167	0522660167	DEK 5 GW h	0576261203	DEK 6 FW 251-300	0468660251	DEK 6 GW 28	0526960028
DEK 5 GW 168	0522660168	DEK 5 NEUTRAL	0473360000	DEK 6 FW 301-350	0468660301	DEK 6 GW 29	0526960029
DEK 5 GW 169	0522660169	DEK 5 OR NEUTRAL	0473391690	DEK 6 FW 351-400	0468660351	DEK 6 GW 30	0526960030
DEK 5 GW 170	0522660170	DEK 5 RT NEUTRAL	0473391686	DEK 6 FW 401-450	0468660401	DEK 6 GW 31	0526960031
DEK 5 GW 171	0522660171	DEK 5 SW NEUTRAL	0473391694	DEK 6 FW 451-500	0468660451	DEK 6 GW 32	0526960032
DEK 5 GW 172	0522660172	DEK 5 VI NEUTRAL	0473391689	DEK 6 FW 501-550	0468660501	DEK 6 GW 33	0526960033
DEK 5 GW 173	0522660173			DEK 6 FW 51-100	0468660051	DEK 6 GW 34	0526960034
DEK 5 GW 174	0522660174	DEK 5/3,5 MC FS 1-10	1762320001	DEK 6 FW 551-600	0468660551	DEK 6 GW 35	0526960035
DEK 5 GW 175	0522660175	DEK 5/3,5 MC FS 101-110	1762320101	DEK 6 FW 601-650	0468660601	DEK 6 GW 36	0526960036
DEK 5 GW 176	0522660176	DEK 5/3,5 MC FS 11-20	1762320011	DEK 6 FW 651-700	0468660651	DEK 6 GW 37	0526960037
DEK 5 GW 177	0522660177	DEK 5/3,5 MC FS 111-120	1762320111	DEK 6 FW 701-750	0468660701	DEK 6 GW 38	0526960038
DEK 5 GW 178	0522660178	DEK 5/3,5 MC FS 121-130	1762320121	DEK 6 FW 751-800	0468660751	DEK 6 GW 39	0526960039
DEK 5 GW 179	0522660179	DEK 5/3,5 MC FS 131-140	1762320131	DEK 6 FW 801-850	0468660801	DEK 6 GW 40	0526960040
DEK 5 GW 180	0522660180	DEK 5/3,5 MC FS 141-150	1762320141	DEK 6 FW 851-900	0468660851	DEK 6 GW 41	0526960041
DEK 5 GW 181	0522660181	DEK 5/3,5 MC FS 21-30	1762320021	DEK 6 FW 901-950	0468660901	DEK 6 GW 42	0526960042
DEK 5 GW 182	0522660182	DEK 5/3,5 MC FS 31-40	1762320031	DEK 6 FW 951-999	0468660951	DEK 6 GW 43	0526960043
DEK 5 GW 183	0522660183	DEK 5/3,5 MC FS 41-50	1762320041	DEK 6 FW LN,PE	0632560000	DEK 6 GW 44	0526960044
DEK 5 GW 184	0522660184	DEK 5/3,5 MC FS 51-60	1762320051	DEK 6 FWZ 1-10	0518960001	DEK 6 GW 45	0526960045
DEK 5 GW 185	0522660185	DEK 5/3,5 MC FS 61-70	1762320061	DEK 6 FWZ 101-110	0518960101	DEK 6 GW 46	0526960046
DEK 5 GW 186	0522660186	DEK 5/3,5 MC FS 71-80	1762320071	DEK 6 FWZ 11-20	0518960011	DEK 6 GW 47	0526960047
DEK 5 GW 187	0522660187	DEK 5/3,5 MC FS 81-90	1762320081	DEK 6 FWZ 111-120	0518960111	DEK 6 GW 48	0526960048
DEK 5 GW 188	0522660188	DEK 5/3,5 MC FS 91-100	1762320091	DEK 6 FWZ 121-130	0518960121	DEK 6 GW 49	0526960049
DEK 5 GW 189	0522660189	DEK 5/3,5 MC GW 0	1755281000	DEK 6 FWZ 131-140	0518960131	DEK 6 GW 50	0526960050
DEK 5 GW 190	0522660190	DEK 5/3,5 MC GW 1	1755280001	DEK 6 FWZ 141-150	0518960141	DEK 6 GW 51	0526960051
DEK 5 GW 191	0522660191	DEK 5/3,5 MC GW 2	1755280002	DEK 6 FWZ 151-160	0518960151	DEK 6 GW 52	0526960052
DEK 5 GW 192	0522660192	DEK 5/3,5 MC GW 3	1755280003	DEK 6 FWZ 161-170	0518960161	DEK 6 GW 53	0526960053
DEK 5 GW 193	0522660193	DEK 5/3,5 MC GW 4	1755280004	DEK 6 FWZ 171-180	0518960171	DEK 6 GW 54	0526960054
DEK 5 GW 194	0522660194	DEK 5/3,5 MC GW 5	1755280005	DEK 6 FWZ 181-190	0518960181	DEK 6 GW 55	0526960055
DEK 5 GW 195	0522660195	DEK 5/3,5 MC GW 6	1755280006	DEK 6 FWZ 191-200	0518960191	DEK 6 GW 56	0526960056
DEK 5 GW 196	0522660196	DEK 5/3,5 MC GW 7	1755280007	DEK 6 FWZ 201-210	0518960201	DEK 6 GW 57	0526960057
DEK 5 GW 197	0522660197	DEK 5/3,5 MC GW 8	1755280008	DEK 6 FWZ 21-30	0518960021	DEK 6 GW 58	0526960058
DEK 5 GW 198	0522660198	DEK 5/3,5 MC GW 9	1755280009	DEK 6 FWZ 31-40	0518960031	DEK 6 GW 59	0526960059
DEK 5 GW 199	0522660199			DEK 6 FWZ 41-50	0518960041	DEK 6 GW 60	0526960060
DEK 5 GW 200	0522660200	DEK 6 BL NEUTRAL	0468591693	DEK 6 FWZ 51-60	0518960051	DEK 6 GW 61	0526960061
DEK 5 GW A	0522761021	DEK 6 BR NEUTRAL	0468591692	DEK 6 FWZ 61-70	0518960061	DEK 6 GW 62	0526960062
DEK 5 GW B	0522761022	DEK 6 FS 1-50	0468760001	DEK 6 FWZ 71-80	0518960071	DEK 6 GW 63	0526960063
DEK 5 GW BL/SW -	0576291741	DEK 6 FS 101-150	0468760101	DEK 6 FWZ 81-90	0518960081	DEK 6 GW 64	0526960064
DEK 5 GW C	0522761023	DEK 6 FS 151-200	0468760151	DEK 6 FWZ 91-100	0518960091	DEK 6 GW 65	0526960065
DEK 5 GW D	0522761024	DEK 6 FS 201-250	0468760201	DEK 6 FWZ L1-h	0631961203	DEK 6 GW 66	0526960066
DEK 5 GW E	0522761025	DEK 6 FS 251-300	0468760251	DEK 6 FWZ L1-PE	0631961187	DEK 6 GW 67	0526960067
DEK 5 GW F	0522761026	DEK 6 FS 301-350	0468760301	DEK 6 FWZ R,S,T,N,g	0631860000	DEK 6 GW 68	0526960068
DEK 5 GW G	0522761027	DEK 6 FS 351-400	0468760351	DEK 6 GE NEUTRAL	0468591687	DEK 6 GW 69	0526960069
DEK 5 GW H	0522761028	DEK 6 FS 401-450	0468760401	DEK 6 GN NEUTRAL	0468591688	DEK 6 GW 70	0526960070
DEK 5 GW I	0522761029	DEK 6 FS 451-500	0468760451	DEK 6 GR NEUTRAL	0468591691	DEK 6 GW 71	0526960071
DEK 5 GW J	0522761030	DEK 6 FS 501-550	0468760501	DEK 6 GW 0	0526961000	DEK 6 GW 72	0526960072
DEK 5 GW K	0522761031	DEK 6 FS 51-100	0468760051	DEK 6 GW 1	0526960001	DEK 6 GW 73	0526960073
DEK 5 GW L	0522761032	DEK 6 FS 551-600	0468760551	DEK 6 GW 2	0526960002	DEK 6 GW 74	0526960074
DEK 5 GW L1	0522361075	DEK 6 FS 601-650	0468760601	DEK 6 GW 3	0526960003	DEK 6 GW 75	0526960075
DEK 5 GW L2	0522361076	DEK 6 FS 651-700	0468760651	DEK 6 GW 4	0526960004	DEK 6 GW 76	0526960076
DEK 5 GW L3	0522361077	DEK 6 FS 701-750	0468760701	DEK 6 GW 5	0526960005	DEK 6 GW 77	0526960077
DEK 5 GW M	0522761033	DEK 6 FS 751-800	0468760751	DEK 6 GW 6	0526960006	DEK 6 GW 78	0526960078
DEK 5 GW MP	0537261235	DEK 6 FS 801-850	0468760801	DEK 6 GW 7	0526960007	DEK 6 GW 79	0526960079
DEK 5 GW N	0522761034	DEK 6 FS 851-900	0468760851	DEK 6 GW 8	0526960008	DEK 6 GW 80	0526960080
DEK 5 GW O	0522761035	DEK 6 FS 901-950	0468760901	DEK 6 GW 9	0526960009	DEK 6 GW 81	0526960081
DEK 5 GW P	0522761036	DEK 6 FS 951-999	0468760951	DEK 6 GW 10	0526960010	DEK 6 GW 82	0526960082
DEK 5 GW PE	0537261187	DEK 6 FSZ 1-10	0133360001	DEK 6 GW 11	0526960011	DEK 6 GW 83	0526960083
DEK 5 GW PEN	0537261188	DEK 6 FSZ 11-20	0133360011	DEK 6 GW 12	0526960012	DEK 6 GW 84	0526960084
DEK 5 GW Q	0522761037	DEK 6 FSZ 21-30	0133360021	DEK 6 GW 13	0526960013	DEK 6 GW 85	0526960085
DEK 5 GW R	0522761038	DEK 6 FSZ 31-40	0133360031	DEK 6 GW 14	0526960014	DEK 6 GW 86	0526960086
DEK 5 GW RT/SW +	0576291737	DEK 6 FSZ 41-50	0133360041	DEK 6 GW 15	0526960015	DEK 6 GW 87	0526960087
DEK 5 GW S	0522761039	DEK 6 FSZ 51-60	0133360051	DEK 6 GW 16	0526960016	DEK 6 GW 88	0526960088
DEK 5 GW T	0522761040	DEK 6 FSZ 61-70	0133360061	DEK 6 GW 17	0526960017	DEK 6 GW 89	0526960089
DEK 5 GW U	0522761041	DEK 6 FSZ 71-80	0133360071	DEK 6 GW 18	0526960018	DEK 6 GW 90	0526960090
DEK 5 GW V	0522761042	DEK 6 FSZ 81-90	0133360081	DEK 6 GW 19	0526960019	DEK 6 GW 91	0526960091
DEK 5 GW W	0522761043	DEK 6 FSZ 91-100	0133360091	DEK 6 GW 20	0526960020	DEK 6 GW 92	0526960092
DEK 5 GW W-STROM	0576261215	DEK 6 FW 1,3,5...99	1358660000	DEK 6 GW 21	0526960021	DEK 6 GW 93	0526960093
DEK 5 GW X	0522761044	DEK 6 FW 1-5 (10X)	0688660000	DEK 6 GW 22	0526960022	DEK 6 GW 94	0526960094

Versions DEK

Type/Print	Order No.	Type/Print	Order No.
DEK 6 GW 95	0526960095	DEK 8 FSZ 41-50	1289660041
DEK 6 GW 96	0526960096	DEK 8 FSZ 51-60	1289660051
DEK 6 GW 97	0526960097	DEK 8 FSZ 61-70	1289660061
DEK 6 GW 98	0526960098	DEK 8 FSZ 71-80	1289660071
DEK 6 GW 99	0526960099	DEK 8 FSZ 81-90	1289660081
DEK 6 GW 100	0526960100	DEK 8 FSZ 91-100	1289660091
DEK 6 GW BL/SW -	1318091741	DEK 8 FW 1-50 TAMPOPR.	1653340001
DEK 6 GW PE	1318061187	DEK 8 FW 51-100 TAMPOPR.	1653340051
DEK 6 GW RT/SW +	1318091737	DEK 8 FWZ 1-10	1276960001
DEK 6 GW +	1318061198	DEK 8 FWZ 101-110	1276960101
DEK 6 GW -	1318061199	DEK 8 FWZ 11-20	1276960011
DEK 6 GW g	1318061202	DEK 8 FWZ 111-120	1276960111
DEK 6 GW h	1318061203	DEK 8 FWZ 121-130	1276960121
DEK 6 NEUTRAL	0468560000	DEK 8 FWZ 131-140	1276960131
DEK 6 OR NEUTRAL	0468591690	DEK 8 FWZ 141-150	1276960141
DEK 6 RT NEUTRAL	0468591686	DEK 8 FWZ 21-30	1276960021
DEK 6 SW NEUTRAL	0468591694	DEK 8 FWZ 31-40	1276960031
DEK 6 VI NEUTRAL	0468591689	DEK 8 FWZ 41-50	1276960041
DEK 6,5 BL NEUTRAL	0468091693	DEK 8 FWZ 51-60	1276960051
DEK 6,5 FS 1-50	0468260001	DEK 8 FWZ 61-70	1276960061
DEK 6,5 FS 101-150	0468260101	DEK 8 FWZ 71-80	1276960071
DEK 6,5 FS 51-100	0468260051	DEK 8 FWZ 81-90	1276960081
DEK 6,5 FSZ 1-10	0407360001	DEK 8 FWZ 91-100	1276960091
DEK 6,5 FSZ 11-20	0407360011	DEK 8 GE NEUTRAL	1277091687
DEK 6,5 FSZ 21-30	0407360021	DEK 8 GN NEUTRAL	1277091688
DEK 6,5 FSZ 31-40	0407360031	DEK 8 NEUTRAL	1277060000
DEK 6,5 FSZ 41-50	0407360041	DEK 8 OR NEUTRAL	1277091690
DEK 6,5 FSZ 51-60	0407360051	DEK 8 RT NEUTRAL	1277091686
DEK 6,5 FSZ 61-70	0407360061	DEK 8 SONDERDR. WEIS	1326660000
DEK 6,5 FSZ 71-80	0407360071	DEK 8 VI NEUTRAL	1277091689
DEK 6,5 FSZ 81-90	0407360081		
DEK 6,5 FSZ 91-100	0407360091		
DEK 6,5 FW 1-50	0468160001		
DEK 6,5 FW 101-150	0468160101		
DEK 6,5 FW 151-200	0468160151		
DEK 6,5 FW 201-250	0468160201		
DEK 6,5 FW 251-300	0468160251		
DEK 6,5 FW 301-350	0468160301		
DEK 6,5 FW 351-400	0468160351		
DEK 6,5 FW 401-450	0468160401		
DEK 6,5 FW 451-500	0468160451		
DEK 6,5 FW 501-550	0468160501		
DEK 6,5 FW 51-100	0468160051		
DEK 6,5 FW L1- h	0632161203		
DEK 6,5 FW L1-PE	0632161187		
DEK 6,5 FWZ 1-10	0519060001		
DEK 6,5 FWZ 11-20	0519060011		
DEK 6,5 FWZ 21-30	0519060021		
DEK 6,5 FWZ 31-40	0519060031		
DEK 6,5 FWZ 41-50	0519060041		
DEK 6,5 FWZ 51-60	0519060051		
DEK 6,5 FWZ 61-70	0519060061		
DEK 6,5 FWZ 71-80	0519060071		
DEK 6,5 FWZ 81-90	0519060081		
DEK 6,5 FWZ 91-100	0519060091		
DEK 6,5 FWZ R,S,T,N,ERD	0632060000		
DEK 6,5 GE NEUTRAL	0468091687		
DEK 6,5 GN NEUTRAL	0468091688		
DEK 6,5 NEUTRAL	0468060000		
DEK 6,5 OR NEUTRAL	0468091690		
DEK 6,5 RT NEUTRAL	0468091686		
DEK 6,5 SW NEUTRAL	0468091694		
DEK 6,5 VI NEUTRAL	0468091689		
DEK 8 BEDR./FARBIG	1289690000		
DEK 8 FS 1-50 TAMPOPR.	1653350001		
DEK 8 FS 51-100 TAMPOPR.	1653350051		
DEK 8 FSZ 1-10	1289660001		
DEK 8 FSZ 11-20	1289660011		
DEK 8 FSZ 21-30	1289660021		
DEK 8 FSZ 31-40	1289660031		

DEK MultiCard

The Dekafix marker in MultiCard format is the universal marker for all kinds of connectors and also electronic modules from the Weidmüller product range. The blank DEK marker is ideal for flexible, fast printing in situ with our innovative labelling systems SMark-Laser, PrintJet, MCP Plus Plotter or MCMobile. The system is particularly suitable for short sequences of numbers and is also available with special printing.

- In strips for fast installation
- Flexible, fast printing on site during installation
- Excellent printing quality thanks to the Weidmüller MultiCard printers
- Available in 6 widths
- Custom printing with the MC Laser also possible

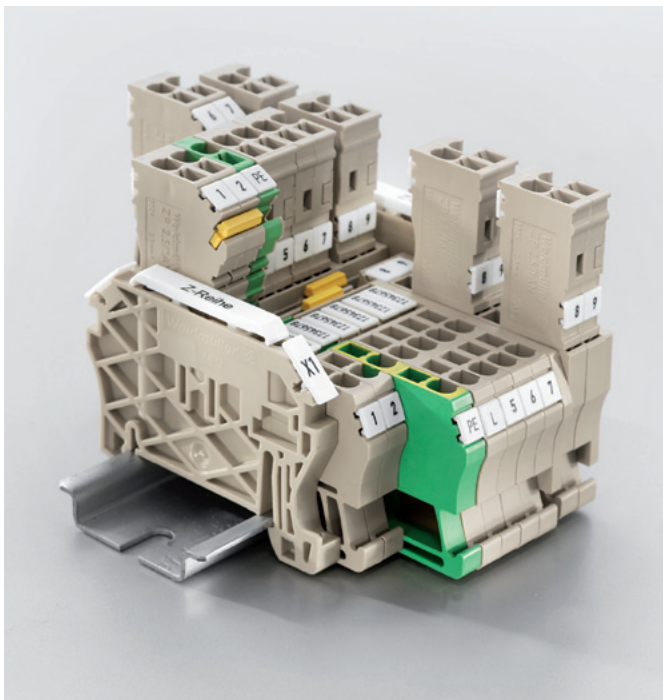
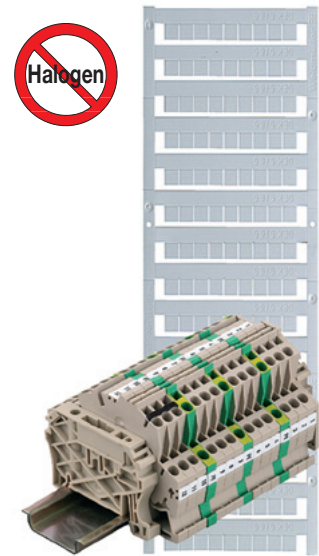

Technical data

Material	Polyamide 66, halogen-free
UL94 flammability rating	V2
Temperature range	-40 °C to 100 °C
Printing	black

Ordering data

Colour	Available in all colours of the international colour code; for MC on request		
	● brown	● red	● orange
	● yellow	● green	● blue
	● violet	● grey	○ white
Special printing	Specify special printing and colours per diskette, Excel file or using the M-Print® PRO software.		
Minimum order quantity	1 pack		
Notes on mounting	<p>Mount in strips when the marker pitch (width) corresponds to the pitch of the terminals. For example, DEK 5 mm pitch for terminals with 5 mm pitch such as the WDU 2.5.</p> <p>Mount individual markers when the terminal pitch is larger than the marker pitch (width). For example, DEK 6.5 mount individually on WDU 6 terminals. Weidmüller markers with 5 mm pitch (width) are suitable for all widths of terminals.</p>		

Dekafix is the universal marker for the SAK series, W series, Z series, P series, and I series as well as for plug-type connectors and electronic sub-assemblies.

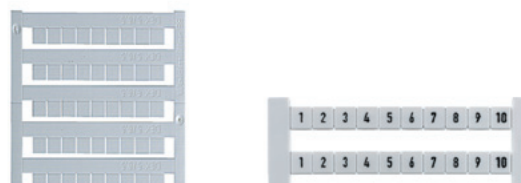

Clamping width: 3.5 mm

DEK - blank

Ordering data

Type	Material colour	Length	Qty.	Order No.
DEK 5/3.5 MC	white	5 mm	500	1755270000

DEK - Custom printing

Type	Material colour	Length	Qty.	Order No.
DEK 5/3.5 MC	white	5 mm	100	1767730000

Clamping width: 5.0 mm

DEK - blank

Type	Material colour	Length	Qty.	Order No.
DEK 5/5 Plus MC	white	5 mm	1000	1854490000
DEK 5/5 Plus MC GE	yellow	5 mm	1000	1907520000
DEK 5/5 MC	white	5 mm	1000	1609801044
DEK 5/5 MC GE	yellow	5 mm	1000	1609801687
DEK 5/5 MC BL	blue	5 mm	1000	1609801693
DEK 5/5 MC GR	grey	5 mm	1000	1609801691
DEK 5/5 MC GN	green	5 mm	1000	1609801688
DEK 5/5 MC RT	red	5 mm	1000	1609801686

DEK - Custom printing

Type	Material colour	Length	Qty.	Order No.
DEK 5/5 MC	white	5 mm	200	1609810000
DEK 5/5 Plus MC	white	5 mm	200	1854500000

Clamping width: 6.0 / 6.5 mm

DEK - blank

Type	Material colour	Length	Qty.	Order No.
DEK 5/6 MC	white	5 mm	1000	1609820000
DEK 5/6 MC PLUS	white	5 mm	1000	1011320000
DEK 5/6.5 MC	white	5 mm	900	1609840000
DEK 5/6.5 PLUS MC	NEW white	5 mm	900	1046340000

DEK - Custom printing

Type	Material colour	Length	Qty.	Order No.
DEK 5/6 MC SDR	white	5 mm	200	1609830000
DEK 5/6 MC SDR PLUS	white	5 mm	200	1038650000
DEK 5/6.5 MC	white	5 mm	180	1609850000
DEK 5/6.5 PLUS MC	NEW white	5 mm	180	1046360000

Clamping width: 7.5 / 8.0 mm

DEK - blank

Type	Material colour	Length	Qty.	Order No.
DEK 5/7.5 MC	white	5 mm	320	1720620000
DEK 5/8 MC	white	5 mm	800	1856740000
DEK 5/8 PLUS MC	NEW white	5 mm	800	1046350000

DEK - Custom printing

Type	Material colour	Length	Qty.	Order No.
DEK 5/7.5 MC	white	5 mm	64	1770490000
DEK 5/8 MC	white	5 mm	160	1856750000
DEK 5/8 PLUS MC	NEW white	5 mm	160	1046370000

WS

WS markers are designed specifically for W series terminals. But thanks to their system compatibility, WS markers can also be used with the I series, Z series and P series. The generous size of these markers permit long characters strings and multiple-line printing.

WS markers are ideal for labelling where long, individual character strings are required. And the proven MultiCard format makes labelling possible with the SMark-Laser, PrintJet, MCP Plus Plotter or MC-Mobilo as well.

- Mount in strips or individually
- Markers in the proven MultiCard format
- Excellent printing quality thanks to the Weidmüller MultiCard printers

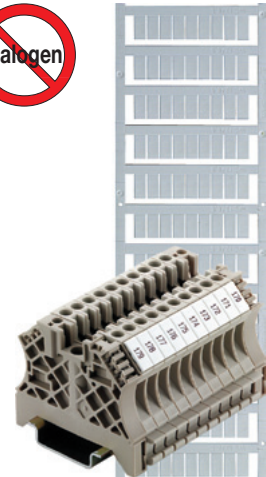

Technical data

Material	Polyamide 66, halogen-free
UL94 flammability rating	V2
Temperature range	-40 °C to 100 °C
Printing	black

Ordering data

Colour	Available in all colours of the international colour code; for MC on request		
	● brown	● red	● orange
	● yellow	● green	● blue
	● violet	● grey	○ white
Special printing	Specify special printing and colours per diskette, Excel file or using the M-Print® PRO software.		
Minimum order quantity	1 pack		
Notes on mounting	<p>Mount in strips when the marker pitch (width) corresponds to the pitch of the terminals. For example, WS 10/6 = 6 mm pitch for terminals with 6 mm pitch such as the WDU 4.</p> <p>Mount individual markers when the terminal pitch is larger than the marker pitch (width). For example, WS 12/6.5 mount individually on WDU 6 terminals. Weidmüller markers with 5 mm pitch (width) are suitable for all widths of terminals.</p>		

ZS

ZS markers – in the proven MultiCard format – were specially developed for Z series terminals. They provide users with a large labelling area. Their unique hinged form means that cross-connectors, for example, are still readily accessible without having to remove the marker. Markers can be clipped on in strips to guarantee fast installation, but individual markers are easily separated.

- Hinged labelling area
- Mount in strips or individually
- Markers in the proven MultiCard format
- Flexible, fast printing on site during installation



Technical data

Material	Polyamide 66, halogen-free
UL94 flammability rating	V2
Temperature range	-40 °C to 100 °C
Printing	black

Ordering data

Colour	white
Notes on mounting	height x width (pitch), e.g. ZS 10/5: 10 mm high, 5 mm wide = 5 mm pitch
Special printing	Specify special printing per diskette, Excel file or using the M-Print® PRO software.
Suitable printing systems	SMark-Laser, PrintJet, Plotter MCP Plus or MC-Mobilo
Minimum order quantity	1 pack

Terminal markers – WS / ZS

WS markers are perfect for the connectors of the W-series, I-series, P-series and Z-series. WS 10/5 and 10/6 Middle are fitted with a centre foot and can be used for the I-series. The ZS markers are specially conceived for the Z-series.

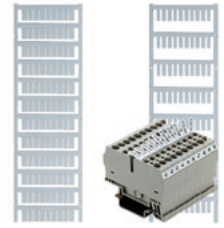

Clamping width: 3.5 mm

WS - blank

Ordering data

Type	Material colour	Length	Qty.	Order No.
WS 12/3.5 MC	white	12 mm	600	1778270000

WS - Custom printing

Type	Material colour	Length	Qty.	Order No.
WS 12/3.5 MC	white	12 mm	120	1778280000

Clamping width: 5.0 mm

WS - blank

Type	Material colour	Length	Qty.	Order No.
WS 8/5 MC	white	8 mm	720	1640740000
WS 8/5 MC GE	yellow	8 mm	720	1773521687
WS 8/5 MC RT	red	8 mm	720	1773521686
WS 8/5 MC BL	blue	8 mm	720	1773521693
WS 8/5 MC OR	orange	8 mm	720	1773521690
WS 8/5 PLUS MC	white	8 mm	600	1951870000
WS 10/5 MC	white	10 mm	720	1635000000
WS 10/5 MC GE	yellow	10 mm	720	1773531687
WS 10/5 MC Middle	white	10 mm	720	1792000000
WS 10/5 MC RT	red	10 mm	720	1773531686
WS 10/5 MC BL	blue	10 mm	720	1773531693
WS 10/5 PLUS MC	NEW white	10 mm	600	1046380000
WS 12/5 MC	white	12 mm	720	1609860000
WS 12/5 MC GE	yellow	12 mm	720	1773541687
WS 12/5 MC RT	red	12 mm	720	1773541686
WS 12/5 MC BL	blue	12 mm	720	1773541693
WS 12/5 MC OR	orange	12 mm	720	1773541690
WS 12/5 MC PLUS	white	12 mm	600	1927510000
WS 14/5 MC	white	14 mm	480	1768090000
WS 15/5 MC	white	15 mm	480	1609880000
WS 15/5 MC GE	yellow	15 mm	480	1773571687

WS - Custom printing

Type	Material colour	Length	Qty.	Order No.
WS 8/5 MC	white	8 mm	144	1640750000
WS 8/5 MC PLUS	white	8 mm	120	1038790000
WS 10/5 MC	white	10 mm	144	1635010000
WS 10/5 MC Middle	white	10 mm	144	1792010000
WS 10/5 PLUS MC	NEW white	10 mm	120	1046320000
WS 12/5 MC	white	12 mm	144	1609870000
WS 12/5 MC PLUS	white	12 mm	120	1927520000
WS 15/5 MC	white	15 mm	96	1609890000

Clamping width: 6.0 mm

WS - blank

Type	Material colour	Length	Qty.	Order No.
WS 8/6 PLUS MC	white	8 mm	600	1951880000
WS 10/6 MC	white	10 mm	600	1828450000
WS 10/6 MC Middle	white	10 mm	600	1818400000
WS 10/6 MC Middle GN	green	10 mm	600	1917420000
WS 10/6 MC Middle GE	yellow	10 mm	600	1917430000
WS 10/6 MC Middle RT	red	10 mm	600	1917440000
WS 10/6 MC Middle OR	orange	10 mm	600	1917410000
WS 10/6 PLUS MC	NEW white	10 mm	600	1046390000
WS 12/6 MC	white	12 mm	600	1609900000
WS 12/6 MC GE	yellow	12 mm	600	1773551687
WS 12/6 MC RT	red	12 mm	600	1773551686
WS 12/6 MC BL	blue	12 mm	600	1773551693
WS 12/6 MC OR	orange	12 mm	600	1773551690
WS 12/6 MC BR	brown	12 mm	600	1773551692
WS 12/6 MC VI	violet	12 mm	600	1773551689
WS 12/6 MC PLUS	white	12 mm	600	1927530000

WS markers are perfect for the connectors of the W-series, I-series, P-series and Z-series. WS 10/5 and 10/6 Middle are fitted with a centre foot and can be used for the I-series. The ZS markers are specially conceived for the Z-series.

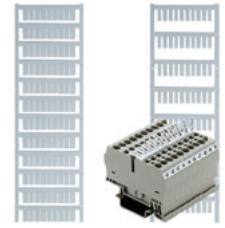

WS - Custom printing

Ordering data

Type	Material colour	Length	Qty.	Order No.
WS 8/6 PLUS MC	white	8 mm	120	1038820000
WS 10/6 MC	white	10 mm	120	1828460000
WS 10/6 MC Middle	white	10 mm	120	1818410000
WS 10/6 PLUS MC	NEW white	10 mm	120	1046330000
WS 12/6 MC	white	12 mm	120	1609910000
WS 12/6 MC PLUS	white	12 mm	120	1927540000

Clamping width: 6.5 mm

WS - blank

Type	Material colour	Length	Qty.	Order No.
WS 12/6.5 MC	white	12 mm	540	1609920000
WS 12/6.5 MC GE	yellow	12 mm	540	1773561687
WS 12/6.5 MC RT	red	12 mm	540	1773561686
WS 12/6.5 MC BL	blue	12 mm	540	1773561693
WS 12/6.5 MC GN	green	12 mm	540	1773561688

WS - Custom printing

Type	Material colour	Length	Qty.	Order No.
WS 12/6.5 MC	white	12 mm	108	1609930000

Clamping width: 8.0 mm

WS - blank

Type	Material colour	Length	Qty.	Order No.
WS 10/8 MC	white	10 mm	420	1905950000
WS 12/8 MC	white	12 mm	420	1906000000

WS - Custom printing

Type	Material colour	Length	Qty.	Order No.
WS 10/8 MC	white	10 mm	84	1906030000
WS 12/8 MC	white	12 mm	84	1906010000

Clamping width: 12.0 / 15.0 mm

WS - blank

Type	Material colour	Length	Qty.	Order No.
WS 10/12 MC	white	10 mm	300	1905970000
WS 10/15 MC	white	10 mm	240	1854090000

WS - Custom printing

Type	Material colour	Length	Qty.	Order No.
WS 10/12 MC	white	10 mm	60	1906060000
WS 10/15 MC	white	10 mm	48	1854100000

Clamping width: 5.0 mm

ZS - blank

Type	Material colour	Length	Qty.	Order No.
ZS 10/5 MC	white	10 mm	480	1610000000
ZS 15/5 MC	white	15 mm	480	1646630000

ZS - Custom printing

Type	Material colour	Length	Qty.	Order No.
ZS 10/5 MC	white	10 mm	96	1610010000
ZS 15/5 MC	white	15 mm	96	1646640000

Clamping width: 6.0 mm

ZS - blank

Type	Material colour	Length	Qty.	Order No.
ZS 12/6 MC	white	12 mm	400	1610020000

ZS - Custom printing

Type	Material colour	Length	Qty.	Order No.
ZS 12/6 MC	white	12 mm	80	1610030000

Terminal markers – Tag carrier

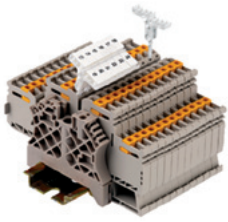

Snap Mark

Technical data

Material	Polyamide 66
UL94 flammability rating	V2
Min. temperature, continuous	-40 °C
Max. temperature, continuous	100 °C
Material colour	white

Accessories

This tag holder is specially conceived for the IDK 1.5N two-tier terminal of the I-series. The flexible hinge mechanism allows cross-connections to be connected or disconnected at little effort. It can be fitted with four DEK 5 tags or two WS 10/5 Middle connector markers.

Ordering data

Type	Length	Width	Qty.	Order No.
Snap Mark I	23 mm	5 mm	50	1805880000

Type	Length	Width	Qty.	Order No.
DEK 5/5 MC	5 mm	5 mm	1000	1609801044
WS 10/5 MC Middle	10 mm	5 mm	720	1792000000



BZT1 / BZT2

Technical data

Material	Polyamide
UL94 flammability rating	V2
Min. temperature, continuous	-40 °C
Max. temperature, continuous	100 °C
Material colour	beige

Accessories

The BZT tag carrier makes possible the clear labelling of the ZDU 2.5/4/6 and ZDUA terminal families. The BZT is used with the WS 10/5 terminal markers. By creating blocks of tag carriers, the ZA version offers the maximum stability.

Ordering data

Type	Length	Width	Qty.	Order No.
BZT 1	8 mm	5 mm	100	1805490000
BZT 1 ZA	8 mm	5 mm	100	1805520000
BZT 2	12 mm	5 mm	100	1805480000
BZT 2 ZA	12 mm	5 mm	100	1805530000

Type	Length	Width	Qty.	Order No.
WS 10/5 MC	10 mm	5 mm	20	1635000000



SchT 5 / SchT 5 S

Technical data

Material	Polyamide 66
UL94 flammability rating	V2
Min. temperature, continuous	-40 °C
Max. temperature, continuous	100 °C
Material colour	beige

Accessories

The SCHT 5 & SCHT 5 S group marker carrier is clipped directly to the TS 32 DIN rail (G-rail) or the TS 35 DIN rail (top-hat rail). It is therefore possible to provide terminal strip labelling irrespective of the terminal and the type of terminal.

Ordering data

Type	Length	Width	Qty.	Order No.
SCHT 5	44.5 mm	19.5 mm	20	0292460000
SCHT 5 S	44.5 mm	9.5 mm	20	1631930000

Type	Length	Width	No. per sheet	Qty.	Order No.
ESO 5 white	40 mm	16.5 mm	60	10	1607710000
ESO 5 yellow	40 mm	16.5 mm	60	10	1631350000
ESO 5P white	40 mm	16.5 mm	60	10	1670370000
ESO 5P yellow	40 mm	16.5 mm	60	10	1670380000
ESO 5 S white	40 mm	7 mm	140	10	1631920000
STR 5 F.SCHT 5	40 mm	16.5 mm	20	20	0294000000
STR 5 S. F.SCHT 5 S	40 mm	7 mm	20	20	1631940000
ELS 7/40 MC NE GE				40	1045650000
ELS 7/40 MC NE WS				40	1045640000
ELS 16/40 MC NE GE				40	1045630000
ELS 16/40 MC NE WS				40	1045620000



SCHT 7

Technical data

Material	Polyamid 66
UL94 flammability rating	V2
Min. temperature, continuous	-40 °C
Max. temperature, continuous	100 °C
Material colour	white

Accessories

The SCHT 7 is a hinged group marker carrier for inlay tags which still allows easy access to the clamping screw. To equip with ESO 7, 4 tags of DEK 5/5 or 2 tags of WS 10/5 Middle.

Ordering data

Type	Length	Width	Qty.	Order No.
SCHT 7	39.3 mm	8 mm	20	0517960000

Type	Length	Width	No. per sheet	Qty.	Order No.
DEK 5/5 MC	5 mm	5 mm		1000	1609801044
ESO 7 white	27 mm	6.3 mm	240	10	1607720000
ESO 7 yellow	27 mm	6.3 mm	240	10	1634780000
ESO 7P white	27 mm	6.3 mm	240	10	1670390000
ESO 7P yellow	27 mm	6.3 mm	240	10	1670400000
STR 7 SCHT 7	27 mm	6.3 mm	20	20	0515300000
WS 10/5 MC Middle	10 mm	5 mm		720	1792000000

Terminal markers – Tag carrier

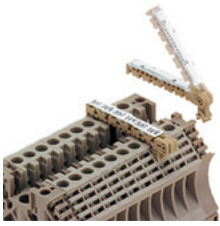

SCHT 9/4 / SCHT 14/6

Technical data

Material	Polyamide 66
UL94 flammability rating	V2
Min. temperature, continuous	-40 °C
Max. temperature, continuous	100 °C
Material colour	beige

Accessories

SchT 9/4 and SchT 14/6 are hinged group tag holders for single dekafix and WS tags, allowing easy access to the clamping screws.

Ordering data

Type	Length	Width	Qty.	Order No.
SCHT 14/6	44.3 mm	6 mm	20	1269060000
SCHT 9/4	32 mm	4 mm	20	1278460000

Type	Length	Width	Qty.	Order No.
DEK 5/5 MC	5 mm	5 mm	1000	1609801044
WS 12/5 MC	12 mm	5 mm	720	1609860000



ELS insertion tag

Technical data

Material	Polyamide PA 66
UL94 flammability rating	V2
Min. temperature, continuous	-40 °C
Max. temperature, continuous	100 °C
Suitable for	ELS 6/30: WKM 8/30 (1631910000) and EM 8/30 (1806120000) ELS 7/40: SchT5S (1631930000) ELS 16/40: SchT5 (0292460000) and WKM 18/43 (1610700000)

The ELS-type MultiCard marker can be printed on with PrintJet, plotter or SMark printer. Colour printing with the PrintJet PRO, in particular, enables cables and terminal strips to be labelled in a variety of noticeable manners.



Ordering data

Type	Colour	Qty.	Order No.
NEW			
blank			
ELS 6/30 MC NE WS	white	80	1045570000
ELS 6/30 MC NE GE	yellow	80	1045580000
ELS 7/40 MC NE WS	white	40	1045640000
ELS 7/40 MC NE GE	yellow	40	1045650000
ELS 16/40 MC NE WS	white	40	1045620000
ELS 16/40 MC NE GE	yellow	40	1045630000
Custom printing			
ELS 6/30 MC SDR		16	1045660000
ELS 7/40 MC SDR		8	1045700000
ELS 16/40 MC SDR		8	1045690000



EM 8/30

Technical data

Material	Polypropylene
UL94 flammability rating	HB
Min. temperature, continuous	-40 °C
Max. temperature, continuous	80 °C
Material colour	transparent

Accessories

Technical data

ESO...P	= Polyester
ESO	= Paper

The EM 8/30 end bracket marker is suitable for labelling the WEW 35/2 and ZEW 35/2 end brackets as well as marker carrier for W-series terminals. The EM 8/30 can be fitted with the ESO 7 and ESO 7P inlay tags. The pocket guarantees that the labelling is well protected against environmental influences.

Ordering data

Type	Length	Width	Qty.	Order No.
EM 8/30	30 mm	8 mm	50	1806120000

Type	Length	Width	No. per sheet	Qty.	Order No.
ESO 7 white	27 mm	6.3 mm	240	10	1607720000
ESO 7 yellow	27 mm	6.3 mm	240	10	1634780000
ESO 7P white	27 mm	6.3 mm	240	10	1670390000
ESO 7P yellow	27 mm	6.3 mm	240	10	1670400000

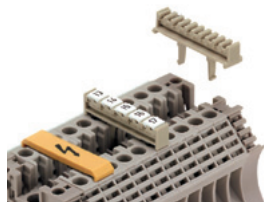

WGB 5 / WGB 8 / WAD

Technical data

Material	Polyamide 66
UL94 flammability rating	V2
Min. temperature, continuous	-40 °C
Max. temperature, continuous	100 °C

Ordering data

Type	Length	Width	Material colour	Qty.	Order No.
WGB 5	33.5 mm	5 mm	beige	50	1050760000
WGB 8	33.5 mm	7.7 mm	beige	50	1050960000
WAD 5 MC NE WS	33.5 mm	5 mm	white	48	1112910000
WAD 5 MC NE GE	33.5 mm	5 mm	yellow	48	1112920000
WAD 5 MC B GE/SW flash	33.5 mm	5 mm	yellow	48	1120450000
WAD 8 MC NE WS	33.5 mm	8 mm	white	48	1112940000
WAD 8 MC NE GE	33.5 mm	8 mm	yellow	48	1112950000
WAD 8 MC B GE/SW flash	33.5 mm	8 mm	yellow	48	1120470000
WAD 12	36.2 mm	12 mm	white	50	1056260000
WAD 12 flash	36.2 mm	12 mm	yellow	50	1055960000
WAD 27	64 mm	27 mm	white	10	1062960000
WAD 27 flash	64 mm	27 mm	yellow	10	1062860000

WAD – Custom printing

Type	Length	Width	Material colour	Qty.	Order No.
WAD 5	33.5 mm	5 mm	white/yellow	12	1112930000
WAD 8	33.5 mm	8 mm	white/yellow	12	1112970000

Accessories WGB 5 / WGB 8

Type	Length	Width	Qty.	Order No.
DEK 5/5 MC	5 mm	5 mm	1000	1609801044
DEK 5/30 MC	30 mm	5 mm	100	1951920000
DEK 5/30 MC SDR	30 mm	5 mm	40	1025680000
WS 12/5 MC	12 mm	5 mm	720	1609860000

Terminal markers - Tag carrier



The ZGB 15 / ZGB 30 is a hinged marker carrier. The tag holder can be fitted with the dekafix 5, WS 12/5 connector markers or with the push-in tag ESO 15 / ESO 7.

ZGB 15 / ZGB 30

Technical data

Material	Polyamide 66
UL94 flammability rating	V2
Min. temperature, continuous	-40 °C
Max. temperature, continuous	100 °C
Material colour	white

Accessories

Ordering data

Type	Length	Width	Qty.	Order No.
ZGB 15	15 mm	7 mm	20	1636530000
ZGB 30	32 mm	7 mm	20	1611930000

Type	Length	Width	No. per sheet	Qty.	Order No.
DEK 5/5 MC	5 mm	5 mm		1000	1609801044
DEK 5/30	30 mm	5 mm		100	1951920000
DEK 5/30 SDR	30 mm	5 mm		40	1025680000
ESO 7 white	27 mm	6.3 mm	240	10	1607720000
ESO 7 yellow	27 mm	6.3 mm	240	10	1634780000
ESO 7P white	27 mm	6.3 mm	240	10	1670390000
ESO 7P yellow	27 mm	6.3 mm	240	10	1670400000
ESO 15 white	15 mm	6 mm	120	1	1636510000
STR 7 SCHT 7	27 mm	6.3 mm	20	20	0515300000
STR 15 ZGB 15	15 mm	6.3 mm	20	20	1636520000
WS 12/5 MC	12 mm	5 mm		720	1609860000

Printing systems and software

The Weidmüller labelling systems are the quick and efficient way of producing markers for connectors, wires, cables and devices, plus labels for general use. The **M-Print® PRO** software enables users to mark electrical equipment quickly and simply. For professional and fast design, printing and ordering of your marking requirements. Borders, barcodes, graphics or photos can all be easily integrated. The multitude of data conversion routines presents you with fast and flexible options for data integration. The Weidmüller **PrintJet PRO, MCP Plus, MCP Basic, MC-Mobilo** printers plus those of the ThermoMark series can be used for printing.

The **PrintJet PRO** is the recommended model in industrial marking for high-resolution printing and maximum wipe and scratch resistance. The **MCP Plus** plotter provides you with good flexibility because with its positioning frame it can handle more than 160 different types of marker in the MultiCard format. The **MC-Mobilo** is the ideal printer for labelling on site without a PC and a mains power supply, directly during installation work. The printers of the ThermoMark series are ideal for printing labels and/or shrinkable sleeves in excellent quality.



	Printer						
Type of marker	PrintJet PRO	Plotter MCP Plus	MCP Basic	MC Mobilo	THM TwinMark	THM Plus	THM Basic
Technical data							
Technology	Inkjet process	Plotting technique	Plotting technique	Plotting technique	Thermal transfer	Thermal transfer	Thermal transfer
Voltage	AC 230 V/AC 115 V	AC 230/AC 115 V	AC 230/AC 115 V	AC 230/AC 115 V	AC 230/AC 115 V	AC 230/AC 115 V	AC 230/AC 115 V
Printing resolution	1.200 dpi				300 dpi	300 dpi	203 dpi
Interfaces	USB, LAN	Parallel Centronics, USB	USB	RS 232	RS 232, USB, LAN	RS 232, USB, LAN, Compact Flash	Parallel Centronics, USB, RS 232, LAN
Network interface card	●				●	●	●
Terminal markers							
DEK/WS/ZS/MF	●	●	●	●			
ELS	●	●	●	●			
WAD	●						
Cable and wire markers							
SF/SFX/SFC	●	●	●	●			
TM-I	●	●	●	●			
ELS	●	●	●	●			
Device markers							
DMC	●	●	●	●			
ESG	●	●	●	●			
SM/CC	●	●	●	●			
Labels							
THM MT						●	●
THM WriteOn						●	●
THM GEW						●	●
THM EL							●
THM ET S7						●	●
Shrink sleeves							
TwinMark					●	●	

PrintJet PRO

The **PrintJet PRO** inkjet printer prints markers for electric connectivity. These markers can be used for clear equipment identification on devices, cables and connectors. The labelling makes servicing, maintenance and troubleshooting much easier. Water-based ink is used for the black or spot colour printing. The print is crystal clear and resistant to environmental influences.

The **PrintJet PRO** prints plastic markers in **MultiCard** format. In combination with the user-friendly **M-Print® PRO** software and the attached loader, the printer is an essential part of the production. The inkjet process being used, the subsequent fusing, as well as the printer cartridge and ink have all been specially adapted by Weidmüller for industrial use. The printer has excellent long-term use capabilities, thanks to its integrated loader.



- Top-quality, resistant printing
- Spot colour print
- Perfect for constant use
- Integrated loader for 20 MultiCards
- Ideal for large quantities
- The display shows all relevant information
- Flexible connection options, from LAN ports to USB ports

Technical data

PrintJet PRO	
Type	PrintJet PRO
Application	Prints MultiCard marker
Technology	Inkjet process
Print quality	600 / 1.200 dpi
Printer drivers	Windows® 2000/XP/VISTA/7
Print software	M-Print® PRO
System requirements	Windows® 2000/XP/VISTA/7
Feed	Integrated loader
Fusing	Thermal fusing
Interface	USB, LAN
Power supply	AC 230 V/AC 115 V
Location	Office conditions
Ambient temperature	20 °C to 35 °C
Dimensions (L x W x H)	1060 x 500 x 310 mm
Weight	33 kg
Cartridge system	Ink cartridge, CMYK (up to 1,000,000 characters, Arial font size 6)
Scope of supply	PrintJet PRO, power cable, printer drivers, manuals (CD), Ink tank starter set colour, USB cable, M-Print® PRO software

Ordering data

Type	Order No.	PrintJet PRO
PrintJet PRO 115V	1024050000	
PrintJet PRO 230V	1001180001	
Accessories		
PJ PRO TNTK INK SET COL	Ink tank starter set, colour	1027110000
PJ PRO TNTK INK K	● Ink tank Black	1027040000
PJ PRO TNTK INK C	● Ink tank Cyan	1027050000
PJ PRO TNTK INK M	● Ink tank Magenta	1027060000
PJ PRO TNTK INK Y	● Ink tank Yellow	1027070000
PJ PRO TNAW	waste pad	1024140000
Ink tank PrintJet II		1858920000
Clean Unit PrintJet II		1858950000
Ink tank PrintJet		1797460000
Clean Unit PrintJet		4062150000

MCP Plus

The plotter MCP Plus complements the Weidmüller MultiCard concept. It is suitable for smaller quantities of markers and when only part of a MultiCard is to be printed on. The special positioning frame for five MultiCards increases productivity by 20 % over comparable systems. With the positioning frame for SlimFix markers sizes 4 to 6, printing on more than 160 MultiCard types for terminals, cables, wires and equipment is possible. Labels are printed with the MCP-Label positioning frame. Suitable for use with the Weidmüller M-Print® PRO software.

- 2 positioning frames for more than 160 MultiCard types
- MultiCards easily fitted into the frame
- Easy to use with partly used MultiCards
- Automatic pen activation function
- Safe storage of the plotter pens

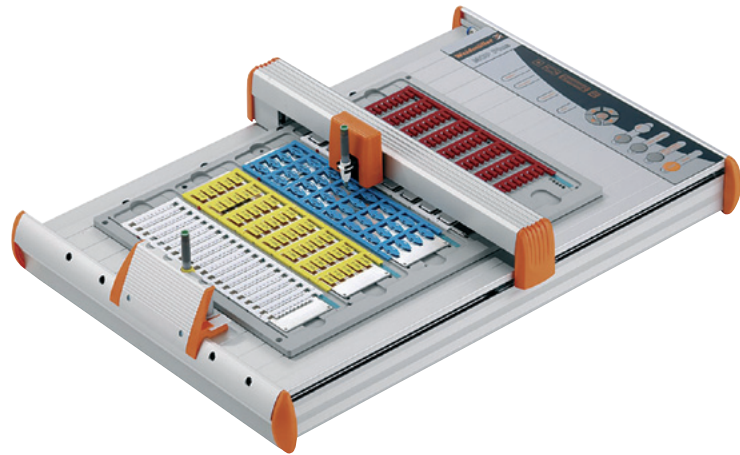

Technical data

Type	MCP Plus
Application	printing of MultiCard markers and labels
Technology	plotting technique
Print software	M-Print® PRO
System requirements	Windows 2000/XP/VISTA/7
Interface	Parallel Centronics / USB
Power supply	230/115 V AC
Feed	manual
Location	office conditions
Ambient temperature	10 °C - 35 °C
Dimensions (L x W x H)	660 x 440 x 125 mm
Weight	approx. 8 kg
Scope of supply	MCP Plus with Centronics cable, USB cable, power pack (100-240 V AC/50-60 Hz), Euro and US plugs, MultiCard positioning frame, 0.25 P-Ink plotter pen, printer driver, M-Print® PRO software and manual

Ordering data

Type	Order No.
MCP Plus plotter set	192500000

MCP Plus

MCP Basic

The **MCP Basic** plotter is a flexible and portable solution that allows you to print your labels on-site quickly and easily.

The **MCP Basic** is suited for printing small-scale labelling jobs, partial labels, or remaining quantities

- Small space-saving flat-bed plotter
- Positioning frame for 3 MultiCards
- Easily filled with MultiCard sheets
- Positioning frame for SlimFix, sizes 4 to 6 and a label positioning frame optionally available
- Works together with Weidmüller's **M-Print® PRO** software

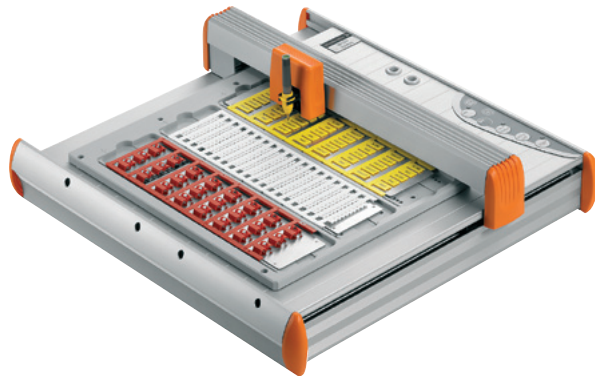

Technical data

Type	MCP Basic
Application	Printing MultiCard markers and labels
Technology	plotting technique
Plotting speed	max. 40 mm/s
System requirements	Windows® 2000/XP/VISTA/7
Software	M-Print® PRO
Interfaces	USB
Voltage supply	100~240 V AC, 50-60 Hz
Voltage supply	Via external power supply unit with interchangeable adapters
Feed	manual
Location	office conditions
Ambient temperature	10 °C - 35 °C
Dimensions (L x W x H) mm	440 x 440 x 125
Weight	6 kg
Scope of supply	MCP Basic plotter, printer driver, power cord, USB cable, M-Print® PRO software, 0.25 P-Ink plotter pen, MultiCard positioning frame, power supply unit (100-240 V AC / 50-60 Hz), Euro and US plugs, user manual on CD, hand trolley-case

Ordering data

MCP Basic

Type	Order No.
MCP Basic	113940000

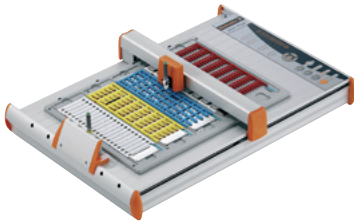
MCP

MCP positioning frames
Ordering data

Type	for	Qty.	Order No.
MCP AP PLUS	MultiCards	1	1924360000
MCP AP BASIC	MultiCards	1	1139880000
MCP AP SF 4-6	SlimFix sizes 4 to 6	1	1924310000
MCP AP Labels	Labels	1	1924370000

MCP plotter pens

Type	for	Qty.	Order No.
Plotter Pen 0.18	Reusable pen	1	1768570000
Plotter Pen 0.25	Reusable pen	1	1768540000
Plotter Pen 0.25 P-Ink	Disposable pen 8 ml	1	1920640000
Plotter Pen 0.35	Reusable pen	1	1768550000
Plotter Pen 0.35 P-Ink	Disposable pen 8 ml	1	1920650000
Plotter Pen 0.50	Reusable pen	1	1768560000
Plotter Pen 0.50 P-Ink	Disposable pen 8 ml	1	1005710000
Plotter Pen 0.70	Reusable pen	1	1011440000
Plotter Pen 0.70 P-Ink	Disposable pen 8 ml	1	1011450000

MCP ink

Type	Contents	Qty.	Order No.
P-Ink	30 ml	1	1924340000
Ink 2000	25 ml	1	1772120000

MCP miscellaneous

Type	Contents	Qty.	Order No.
P cleaner	30 ml	1	1924330000
Cleaner Clean 2000	25 ml	1	1772130000
Inlay for MCP		1	1935130000
Inlay SFC 3		1	1058090000
MCP adhesive strips		5	1924320000
MCP Plus cover		1	1924350000
MCP TP-KOF Basic	Trolley MCP Basic	1	1139890000

Accessories – STI pen

The STI-S felt tip pen is suitable for labelling blank Weidmüller marking products. It can be used for handwritten labels or, in conjunction with the STI-S adapter, for a plotter printout. A black, waterproof ink is used.

Ordering data

Type	Qty.	Order No.
Adapter aluminium STI pen	1	1762440000
STI pen SW	10	0508401694

MC-Mobilo

The MC-Mobilo allows users to label electrical equipment, anywhere, at any time as there is no need for a PC and no need for a power supply. The rechargeable battery provides power for up to 3 hours. The universal inlay enables up to 120 different marker types of the MultiCard range to be processed.



Technical data

Type	Plotter
Application	Printing of MultiCard markers
Technology	Plotting technique
Print software	WM-Print
Interface	RS 232
Power supply	AC 230 / AC 115 V
Feed	manual
Location	can be used anywhere
Ambient temperature	15 - 30 °C
Dimensions (L x W x H)	380 x 190 x 68 mm
Weight	3 kg
Scope of supply	MC-Mobilo, universal power unit, including adapters (EURO, UK, USA), data cassette, operating instructions, PowerPack, PC connecting cable, WM-Print, universal MultiCard mounting frame, 0.25 plotter pen, carry case

Ordering data

		Qty.	MC-Mobilo Order No.
MC-Mobilo			
MC-Mobilo 110/220 V		1	1741260001
MC-Mobilo Accessories			
Printkit (Ink 2000, Clean 2000, Plotter-Pen 0.25)		1	1686920000
Frame inlay SF 4-6		1	1802180000
Inlay SFC 3		1	1058090000
Accessories Plotter IP220/MC-Mobilo			
P-Ink 30 ml	Not suitable for CL-T sleeves	1	1924340000
Ink 2000 25 ml		1	1772120000
P cleaner 30 ml		1	1924330000
Cleaner Clean 2000 25 ml		1	1772130000
Plotter Pen 0.18		1	1768570000
Plotter Pen 0.25		1	1768540000
Plotter Pen 0.25 P-Ink	Not suitable for CL-T sleeves	1	1920640000
Plotter Pen 0.35		1	1768550000
Plotter Pen 0.35 P-Ink	Not suitable for CL-T sleeves	1	1920650000
Plotter Pen 0.50		1	1768560000
Plotter Pen 0.50 P-Ink	Not suitable for CL-T sleeves	1	1005710000
Plotter Pen 0.70		1	1011440000
Plotter Pen 0.70 P-Ink	Not suitable for CL-T sleeves	1	1011450000
Accessories – STI pen			
Adapter aluminium STI pen		1	1762440000
STI pen SW	Not suitable for CL-T sleeves	10	0508401694

M-Print® PRO Label Designer

Print and ordering software for markers and labels
M-Print® PRO is a professional software for printing and ordering Weidmüller markers and labels under Windows®. This software helps you to optimise your processes for marking electrical equipment. You can design, print and order your marking materials effortlessly, professionally and quickly: texts, frames, lines, graphics, barcodes, serial numbers and photos.

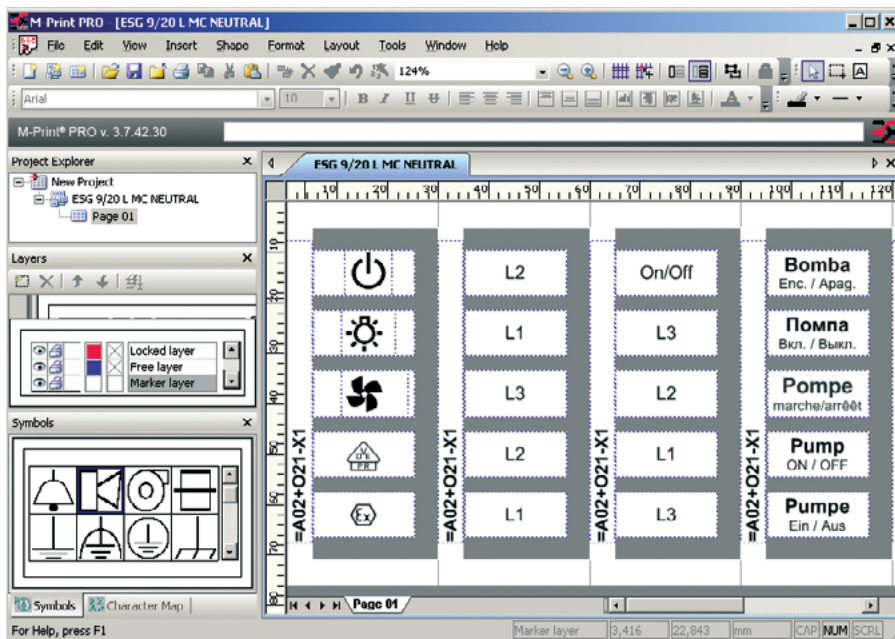

Technical data

Here is an overview of the main functions

- Integrated product catalogue for all labels and markers, including images and links to the relevant web pages and product data sheets
- Custom formatting of individual text characters (RTF)
- Perform copy-and-paste functions with texts and their formats
- Supports UNICODE for foreign-language texts, such as Russian, Chinese, Polish, etc.
- Enter data on labels or worksheet, or directly in Microsoft® Excel
- Numeric and alphanumeric counts and sequences
- Extensive range of image formats (*.bmp, *.wmf, *.png, *.ico, *.jpeg, *.tif, *.gif)
- Image library including all the important symbols used in electrical engineering
- Permanent print preview: see how the printout will look during the design phase
- Supported output devices: PrintJet Pro, PrintJet II, SMark laser, MCP plotter, THM and standard printers with Windows® drivers
- Assign product to specific printer; for example, ESG 9/20 to PrintJet, LaserMark to laser printer, etc.
- Optimum and rapid adjustment of the output devices
- Imports data from CAE systems
- Import assistant to create your own import filter for numerous file formats (*.txt, *.csv, *.xml etc.)
- Markers and labels can be designed in as many levels as required
- Interface to RailDesigner®

Operating systems supported

WINDOWS® 2000/XP/VISTA/7

System requirements

RAM	> 256 MB
Processor	> Pentium III or comparable model
Graphics	> 800 x 600 pixels with 256 colours optimum: 1024 x 768 with 16-bit High Colour
Hard drive	> 90 MB free storage
Miscellaneous	mouse, keyboard, CD-ROM drive (to install the software)

M-Print® PRO is available in two editions:

- M-Print® PRO Standard Edition for professional printing results with all of Weidmüller's marking materials
- M-Print® PRO Advanced Edition for professional printing results with all of Weidmüller's marking materials plus labels to your own specification

Ordering data

M-Print® PRO

Type	Order No.
M-Print® PRO	1905490000
M-Print® PRO advanced	1905500000

Tools

Cutting tools

- Cutting formation for different cable sizes increases the quality of the cuts for smaller cross-sections
- Not suitable for steel wires, steel-armoured cables, aluminium alloys and hard-drawn copper conductors!
- Cutting without deformation of the conductor



F

KT 8





KT 12

KT 22



-  max. 8 mm
-  max. 16 mm²
-  max. 16 mm²
-  max. 16 mm²

-  max. 12 mm
-  max. 16 mm²
-  max. 25 mm²
-  max. 35 mm²

-  max. 22 mm
-  max. 25 mm²
-  max. 50 mm²
-  max. 95 mm²

Technical data

Max. cutting performance, copper cable	
Solid (max. conductor cross-section)	mm ² /AWG
Stranded (max. conductor cross-section)	mm ² /AWG
Flexible (max. conductor cross-section)	mm ² /AWG
Flexible, stranded (max. conductor diameter)	mm
Max. cutting performance, aluminium cable	
Stranded (max. conductor cross-section)	mm ² /-
Stranded (max. conductor diameter)	mm
solid	mm ²
Data / telephone / control cable	
Max. outer diameter	mm
Tool data	
Length / Width / Height	mm
Weight	g
Note	

KT8	KT12
16 / 6	16 / 6
16 / 6	25 / 3
16 / 6	35 / 2
8	12
Max. cutting performance, aluminium cable	
16 / 6	25 / 6
8	8
16	25
Data / telephone / control cable	
8	12
Tool data	
165 / 65 / 25	215 / 66 / 28
180	300
Tool closed	

KT22	
25 / 3	
50 / 1	
95 / 3/0	
22	
Max. cutting performance, aluminium cable	
70 / 2/0	
22	
50	
Data / telephone / control cable	
22	
Tool data	
220 / 66 / 30	
460	
Tool closed	

Ordering data

Version	
Note	

Type	Qty.	Order No.
KT 8	1	9002650000
KT 12	1	9002660000
Note		

Type	Qty.	Order No.
KT 22	1	1157830000
Note		

Cutting and releasing tools

Special release tools for the Weidmüller W-Series terminal connectors.

WAW 1

Notching tool



Tool for releasing poles from WQV 2.5 to WQV 35 cross connections used in Weidmüller W-Series terminal connectors.

WAW 2

Notching tool



Tool for punching out the cross-connection windows of the Weidmüller W-Series terminal connectors, WTR 2.5 disconnect terminal and WSI 6 fuse terminal.

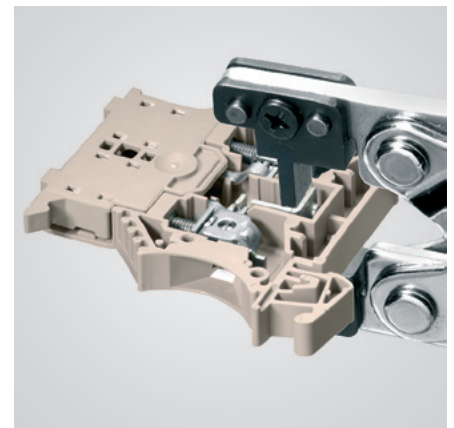
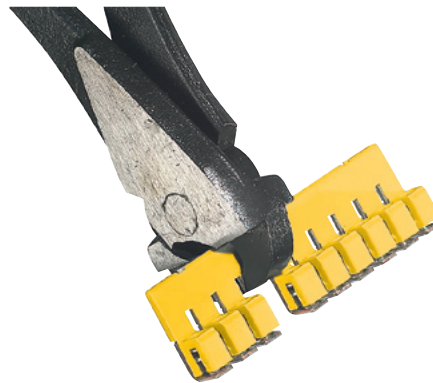

Technical data

Length	mm
Weight	g
Note	

WAW 1
167
227

WAW 2
205
338

Ordering data

Version
Note

Type	Qty.	Order No.
WAW 1 NEUTRAL	1	9004500000
Note		

Type	Qty.	Order No.
WAW 2	1	9004510000
Note		

Tools

Cutting and releasing tools

Special cutting tool for clean pinch-free cutting of Weidmüller Z-Series cross-connections

KT ZQV

Cutting tool



Cutting tool for clean cutting of Weidmüller ZQV Series cross-connections

F

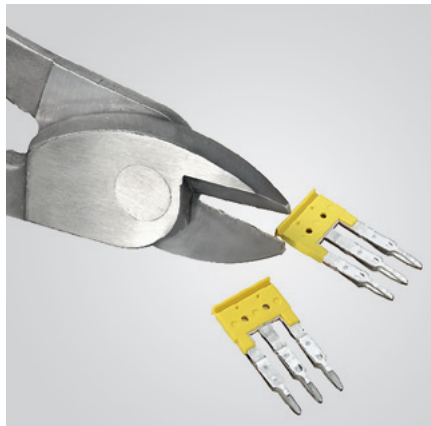

Technical data

Length / Width / Height	mm
Weight	g

KT ZQV
215
300

Note

Ordering data

Version

KT ZQV	Qty.	Order No.
KT ZQV	1	9002170000

Note

Mounting rail cutter



Copper earthing bar



TS 32 mm according to EN 50035 (s = 1.5 mm)



TS 15/5.5 mm according to EN 50045 (s = 1.0 mm)



TS 35/7.5 mm according to EN 50022 (s = 1.0 mm)



TS 35/15 mm according to EN 50022 (s = 1.5 mm)

TSLD

Terminal rail cutting and punching tool



Hand-operated mounting rail cutter for cutting and perforating DIN mounting rails

- Cutting with no burrs or waste
- Length end stop (1000 mm) is included in delivery
- Table-top unit for mounting on workbench or similar work places

VKSW

Wire channel cutter



Manually-operated wire channel cutter: for cutting (up to 125 mm wide) of wire channels and covers.

- Cutting with no burrs or waste
- Length end stop (1000 mm) with feed mechanism for precision-angled cuts
- Table-top unit for mounting on workbench or similar work places
- Hardened cutting edges made from specialized steel.

Technical data

Width	mm	205
Length	mm	270
Height	mm	200
Weight	g	19000
Note		

TSLD		
Width	mm	205
Length	mm	270
Height	mm	200
Weight	g	19000
Note		
Technical data without lever and length end stop		

VKSW		
Width	mm	280
Length	mm	285
Height	mm	290
Weight	g	15000
Note		

Ordering data

Version	
Note	

Type	Qty.	Order No.
TSLD	1	9918700000
TSLD C	1	1270310000
Note		

Type	Qty.	Order No.
VKSW	1	1137530000
Note		

Tools

Cable cutter



- One-hand operation
- Easy handling
- Minimal hand force required
- Release option in every cutting position
- Not suitable for steel wires, steel-armoured cables, aluminium alloys and hard-drawn copper conductors!



F

KT 45 R





-  Cu + Al: max. 45 mm
-  Cu: max. 300 mm²
Al: max. 400 mm²
-  Cu: max. 400 mm²



KT 55



-  Cu + Al: max. 55 mm
-  Cu: max. 500 mm²
Al: max. 500 mm²
-  Cu: max. 500 mm²



Technical data

Max. cutting performance, copper cable	
Stranded (max. conductor cross-section)	mm ² /kcmil
Flexible (max. conductor cross-section)	mm ² /kcmil
Flexible, stranded (max. conductor diameter)	mm
Copper sector cable	
Max. cutting performance, aluminium cable	
Stranded (max. conductor cross-section)	mm ² /kcmil
Stranded (max. conductor diameter)	mm
Aluminium sector cable	
Data / telephone / control cable	
Max. outer diameter	mm
Tool data	
Length / Width / Height	mm
Weight	g
Note	

KT 45 R		
300 / 600		
400 / 800		
45		
3 x 70 SM		
400 / 800		
45		
4 x 70 SE		
45		
290 / 85 / 40		
740		

KT 55		
500 / 1000		
500 / 1000		
55		
3 x 150 SM		
500 / 1000		
55		
4 x 150 SE		
55		
365 / 115 / 45		
1450		

Ordering data

Version
Note

Type	Qty.	Order No.
KT 45 R	1	9202040000
Pivoting blade KT 45 R	1	9204270000
Note		
The dimensions of the cable cutter refer to the delivery condition, i.e. the point of the hinged blade parallel to the fixed blade.		

Type	Qty.	Order No.
KT 55	1	9202060000
Pivoting blade KT 55	1	9204280000
Note		
The dimensions of the cable cutter refer to the delivery condition, i.e. the point of the hinged blade parallel to the fixed blade.		

Sheathing strippers

- Sheathing stripper for PVC cables
- Insulation can be stripped from any point along the cable
- Opening of slit insulation by means of integrated cutter



product
design
award

AM 16

For round cable, Ø 6...17 mm



- Also very suitable for stripping cables in the cable duct

AMF 6/10 AM 16

For ribbon cable, 6 mm² and 10 mm²

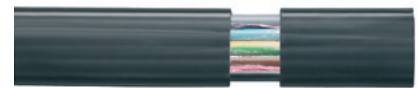
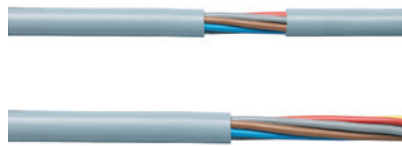

Technical data

Max. stripping performance	
Cable type	-
Conductor cross-section	-
Conductor diameter	mm
Depth of cut	-
Cutting performance	
UTP und STP data cables, max. diameter	mm
Flexible (max. conductor cross-section)	mm ²
Tool data	
Length	mm
Weight	g
Note	

AM 16		
Cable type	PVC round cable	
Conductor diameter	6...17	
Depth of cut	0,8 - 2,5 mm	
Cutting performance		
UTP und STP data cables, max. diameter	mm	
Flexible (max. conductor cross-section)	mm ²	
Tool data		
Length	53	
Weight	60	
Note		

AMF 6/10		
Cable type	PVC ribbon cable	
Conductor diameter	mm	
Depth of cut	0 - 4,0 mm	
Cutting performance		
UTP und STP data cables, max. diameter	mm	
Flexible (max. conductor cross-section)	mm ²	
Tool data		
Length	110	
Weight	115	
Note		

Ordering data

Version
Note

Type	Qty.	Order No.
AM 16	1	9204190000
Note		

Type	Qty.	Order No.
AMF 6/10	1	9204180000
Note		

Accessories

Type
Spare blade
Sheathing stripper
Note

Type	Qty.	Order No.
Spare blade	1	9204260000
Sheathing stripper		
Note		

Type	Qty.	Order No.
Spare blade	1	9204250000
Sheathing stripper		
Note		

Tools

Stripping and cutting tools

- For flexible and solid conductors with PVC insulation
- Cable with double insulation in two processing steps without special adjustment
- Automatic opening of clamping jaws after stripping
- No play in self-adjusting cutting unit
- Long-lasting
- No splicing of single conductors
- Optimised ergonomic design
- Stripping length adjustable via stop
- Adjustable for different insulation thicknesses
- Switchable partial stripping function
- Removable handle shells
- Fold-out cutting protection
- Custom marking with ESG device markers

stripax®

0.08 - 10 mm²

NEW



- Stripping: PVC insulated flexible conductor, size 0.08...10 mm² (~AWG 28...7)
- Cutting: PVC insulated flexible conductor, size 0.08...6 mm² (~AWG 28...10)
- Conductors undamaged due to special self adjusting stripping blades.
- Processing of multi-conductors, with thin flat ribbon cables and even multiple conductors in one operation

stripax® 16

6 - 16 mm²

NEW



- Stripping: PVC insulated flexible and solid conductors (~AWG 10...6)
- Cutting: PVC insulated flexible and solid conductors, up to 6 mm² (AWG 10)
- Conductors undamaged due to special self adjusting stripping blades.

F

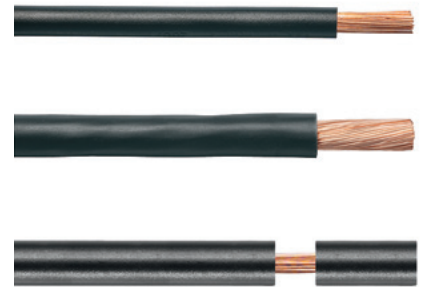
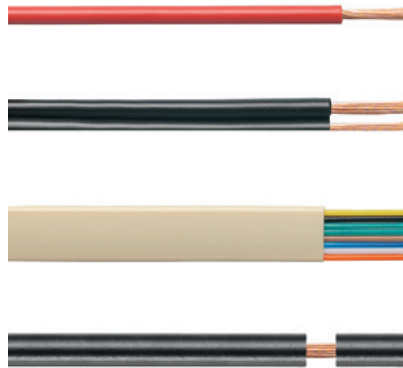
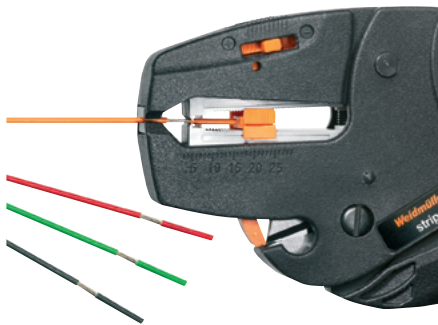

Technical data

Max. stripping performance	
Cable type	
Conductor cross-section	mm ²
Stripping length, max.	mm
Cutting performance	
Max. cutting performance	mm ²
Tool data	
Length	mm
Weight	g
Note	

stripax®		
Flexible and solid conductors with PVC insulation		
0.08...10		
25		
6		
190		
175		
Note		

stripax® 16		
Flexible and solid conductors with PVC insulation		
6...16		
25		
6		
190		
175		
Note		

Ordering data

Version
Note

Type	Qty.	Order No.
stripax®	1	9005000000
Note		

Type	Qty.	Order No.
stripax® 16	1	9005610000
Note		

Accessories

Note

Type	Qty.	Order No.
Spare stripping blades	1	1119030000
Note		

Type	Qty.	Order No.
Spare stripping blades	1	1119040000
Note		

Crimping tools for wire end ferrules

Three functions:

- Cutting
- Stripping
- Crimping

- Wire-end ferrules with plastic collars, in compliance with DIN 46228-4
- Ratchet for precise crimping.
- Efficient operation: Change of tools not necessary, resulting in a significant time savings
- Automatic conveyance of wire-end ferrules
- Quick adjustment for differing cross-sections
- Easy handling of ferrule strips

Only Weidmüller fifty-piece linked ferrule strips can be processed. The use of wire-end ferrules on reels can lead to damage.

stripax® plus 2.5

0.5...2.5 mm²



- For processing linked wire-end ferrules from Weidmüller 0.5...2.5 mm² (~AWG 20...14)

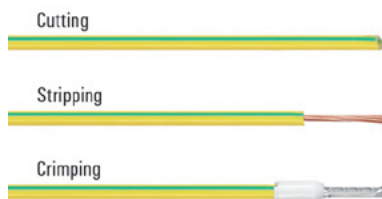

Technical data

Description of contact	
Type of contact	
Crimping range	mm ²
Crimping range 1 (with multiple crimping positions)	mm ²
Crimping range 2 (with multiple crimping positions)	mm ²
Crimping range 3 (with multiple crimping positions)	mm ²
Crimping range 4 (with multiple crimping positions)	-
Crimping range 5 (with multiple crimping positions)	-
Tool data	
Length	mm
Weight	g
Note	

Ordering data

Version
Note

STRIPAX PLUS 2.5	
Type	Strips of linked wire-end ferrules
Crimping range	0.5...2.5
Crimping range 1 (with multiple crimping positions)	0.5...0.75
Crimping range 2 (with multiple crimping positions)	1...1.5
Crimping range 3 (with multiple crimping positions)	2.5
Length	210
Weight	260
Only strip-type products from Weidmüller can be processed. The use of wire-end ferrules on reels can lead to damage.	

Type	Qty.	Order No.
STRIPAX PLUS 2.5	1	9020000000
Spare cutting blade	1	9050340000
Note		

Tools

Crimping tools for wire end ferrules

- For wire-end ferrules with and without plastic collars, according to DIN 46228 T.1 and T.4 (~ AWG 24...16)
- Ratchet for precise crimping.
- Release option in the event of incorrect operation

PZ 4

0.5...4 mm²



- Only one crimping station for the whole cross-section range
- Wire-end ferrule insertion from the side

PZ 6/5

0.25...6 mm²



- Crimp complies with Euro-Norm EN 60947-1
- Approval according to VG 95211 (military designation VG 95 236 T 14 B 002)
- Five crimping stations corresponding to the conductor cross-sections
- Wire-end ferrule insertion from the side



Technical data

Description of contact	
Type of contact	
Crimping range	mm ²
Crimping range 1 (with multiple crimping positions)	mm ²
Crimping range 2 (with multiple crimping positions)	mm ²
Crimping range 3 (with multiple crimping positions)	mm ²
Crimping range 4 (with multiple crimping positions)	mm ²
Crimping range 5 (with multiple crimping positions)	mm ²
Tool data	
Length	mm
Weight	g
Note	

Ordering data

Version
Note

PZ 4		
Wire-end ferrules with/without plastic collars		
Crimping range	0.5...4	
Crimping range 1 (with multiple crimping positions)		
Crimping range 2 (with multiple crimping positions)		
Crimping range 3 (with multiple crimping positions)		
Crimping range 4 (with multiple crimping positions)		
Crimping range 5 (with multiple crimping positions)		
Length	200	
Weight	448	
Note		

Type	Qty.	Order No.
PZ 4	1	9012500000
Note		

PZ 6/5		
Wire-end ferrules with/without plastic collars		
Crimping range	0.25...6	
Crimping range 1 (with multiple crimping positions)	0.25...0.5	
Crimping range 2 (with multiple crimping positions)	0.75...1.5	
Crimping range 3 (with multiple crimping positions)	2.5	
Crimping range 4 (with multiple crimping positions)	4	
Crimping range 5 (with multiple crimping positions)	6	
Length	200	
Weight	423	
Note		

Type	Qty.	Order No.
PZ 6/5	1	9011460000
Note		

Crimping tools for wire end ferrules

- For wire-end ferrules with and without plastic collars, according to DIN 46228 T.1 and T.4 (~ AWG 24...16)
- Ratchet for precise crimping.
- Release option in the event of incorrect operation

PZ 3

0.5...6 mm²



- Only one die for the whole cross-section range
- Wire-end ferrule insertion from the front

PZ 6 roto

0.14...6 mm²



- Only one die for the whole cross-section range
- Rotating die enables wire-end ferrule insertion from the front or side

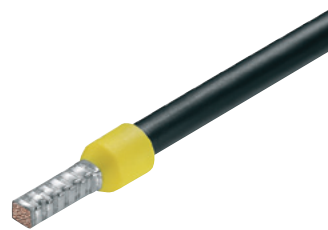

Technical data

Description of contact	
Type of contact	
Crimping range	mm ²
Crimping range 1 (with multiple crimping positions)	mm ²
Crimping range 2 (with multiple crimping positions)	mm ²
Crimping range 3 (with multiple crimping positions)	mm ²
Crimping range 4 (with multiple crimping positions)	mm ²
Crimping range 5 (with multiple crimping positions)	mm ²
Tool data	
Length	mm
Weight	g
Note	

PZ 3		
Wire-end ferrules with/without plastic collars		
Crimping range	0.5...6	
Crimping range 1 (with multiple crimping positions)		
Crimping range 2 (with multiple crimping positions)		
Crimping range 3 (with multiple crimping positions)		
Crimping range 4 (with multiple crimping positions)		
Crimping range 5 (with multiple crimping positions)		
Tool data		
Length	200	
Weight	426	
Note		

PZ 6 Roto		
Wire-end ferrules with/without plastic collars		
Crimping range	0.14...6	
Crimping range 1 (with multiple crimping positions)		
Crimping range 2 (with multiple crimping positions)		
Crimping range 3 (with multiple crimping positions)		
Crimping range 4 (with multiple crimping positions)		
Crimping range 5 (with multiple crimping positions)		
Tool data		
Length	200	
Weight	428	
Note		

Ordering data

Version
Note

Type	Qty.	Order No.
PZ 3	1	0567300000
Note		

Type	Qty.	Order No.
PZ 6 Roto	1	9014350000
Note		

Tools

Crimping tools for wire end ferrules

- For wire-end ferrules with and without plastic collars, according to DIN 46228 T.1 and T.4 (~ AWG 24...16)
- Ratchet for precise crimping.
- Release option in the event of incorrect operation

PZ 16

6...16 mm²

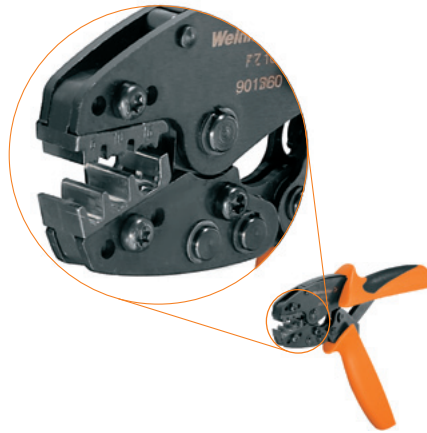

- Crimp complies with Euro-Norm EN 60947-1
- Approval according to VG 95211 (military designation VG 95 236 T 14 B 002)
- Three crimping stations corresponding to the conductor cross-sections
- Wire-end ferrule insertion from the side

PZ ZH 16

Twin wire-end ferrules from 6...16 mm²



- Three crimping stations corresponding to the conductor cross-sections
- Wire-end ferrule insertion from the side



Technical data

Description of contact	
Type of contact	
Crimping range	mm ²
Crimping range 1 (with multiple crimping positions)	mm ²
Crimping range 2 (with multiple crimping positions)	mm ²
Crimping range 3 (with multiple crimping positions)	mm ²
Crimping range 4 (with multiple crimping positions)	mm ²
Crimping range 5 (with multiple crimping positions)	mm ²
Tool data	
Length	mm
Weight	g
Note	

Ordering data

Version
Note

PZ 16		
Wire-end ferrules with/without plastic collars		
6...16		
6		
10		
16		
200		
418		
Note		

Type	Qty.	Order No.
PZ 16	1	9012600000
Note		

PZ ZH 16		
Twin wire-end ferrules		
6...16		
6		
10		
16		
250		
730		
Note		

Type	Qty.	Order No.
PZ ZH 16	1	9013600000
Note		

Crimping tools for wire end ferrules

- For wire-end ferrules with and without plastic collars, according to DIN 46228 T.1 and T.4 (~ AWG 24...16)
- Ratchet for precise crimping.
- Release option in the event of incorrect operation

PZ 50

25...50 mm²



- Crimp complies with Euro-Norm EN 60947-1
- Approval according to VG 95211 (military designation VG 95 236 T 14 B 002)
- Three crimping stations corresponding to the conductor cross-sections
- Wire-end ferrule insertion from the side

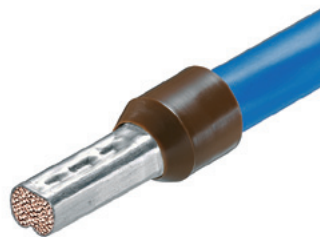

Technical data

Description of contact	
Type of contact	
Crimping range	mm ²
Crimping range 1 (with multiple crimping positions)	mm ²
Crimping range 2 (with multiple crimping positions)	mm ²
Crimping range 3 (with multiple crimping positions)	mm ²
Crimping range 4 (with multiple crimping positions)	-
Crimping range 5 (with multiple crimping positions)	-
Tool data	
Length	mm
Weight	g
Note	

PZ 50	
Wire-end ferrules with/without plastic collars	
25...50	
	25
	35
	50
	250
	730
Note	

Ordering data

Version
Note

Type	Qty.	Order No.
PZ 50	1	9006450000
Note		

Tools

Combined cutting and screw driving tool

That does not damage the edge; for cutting of copper cables.

- Solid cables with a diameter of up to 1.5 mm²
- Flexible cables with a diameter of up to 2.5 mm²

swifty®



swifty®

- Cable cutting tool to mount on non-insulated screw drivers with a blade diameter of 3.5 mm
- Minimum manual force required
- Automatic opening of the cutter
- Ergonomically designed grip

swifty®set

- Efficient operation:
- Only one tool for cable-processing in IDC-technology
- Suitable for screw and tension clamps
- Readily available pocket size
- For right-handed and left-handed use
- One-hand operation

swifty®set



Technical data

Maximum cutting capacity		
Copper cable:		
Solid cable (conductor cross-section)	mm ²	1.5
Flexible cable (conductor cross-section)	mm ²	2.5
Tool data		
Length / Width / Height	mm	35 / 18 / 40
Weight	g	20

Ordering data

Type	Qty.	Order No.
swifty® (without screwdriver)	1	9006020000

Type	Qty.	Order No.
swifty®set (with screwdriver)	1	9006060000
Screwdriver (SD 0.6 3.5x100)	1	9008330000

VDE-insulated screwdriver

VDE-insulated screwdriver with pilot tip, for working on live parts up to 1000 VAC and 1500 VDC, DIN EN 60900, IEC 900, "GS" safety tested, with each individual piece tested. Bit made from fully hardened, high-alloy chromium-vanadiummolybdenum steel, gun-metal finish..

SDIS 2.5-5.5/PH/1/2

6-part set: VDE insulated slotted and crosshead PH screwdriver set



SDIS 2.5-5.5/PZ/1/2

Six-piece set: VDE-insulated slotted and PZ-crosshead screwdriver set



Weidmüller SoftFinish VDE-insulated electric screwdriver for working on live components with up to 1000 V AC and 1500 V DC, DIN EN 60900, IEC 900. "GS" safety-tested and every product tested.

SDIS 2.0-5.5

VDE insulated slot-head screwdriver, SDI DIN 7437, ISO 2380/2, drive output acc. to DIN 5264, ISO 2380/1. SoftFinish grip

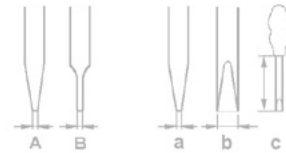

Type	Blade type	Size / AF	a	b	c	Order No.
SDI 0.4x2.5x75			0.4	2.5	80	
SDI 0.5x3.0x100			0.5	3.0	100	
SDI 0.8x4.0x100			0.8	4.0	100	
SDI 1.0x5.5x125			1.0	5.5	125	
SDI PH 1		1			80	
SDI PH 2		2			100	
SDIS 2.5-5.5/PH1/2						9009730000

SDI 0.4x2.5x75	A		0.4	2.5	80	
SDI 0.5x3.0x100	B		0.5	3.0	100	
SDI 0.8x4.0x100	B		0.8	4.0	100	
SDI 1.0x5.5x125	B		1.0	5.5	125	
SDI PZ 1		1			80	
SDI PZ 2		2			100	
SDIS 2.5-5.5/PZ1/2						1128540000

SDI 0.4x2.0x60	A		0.4	2.0	60	
SDI 0.4x2.5x75	A		0.4	2.5	75	
SDI 0.5x3.0x100	B		0.5	3.0	100	
SDI 0.6x3.5x100	B		0.6	3.5	100	
SDI 0.8x4.0x100	B		0.8	4.0	100	
SDI 1.0x5.5x125	B		1.0	5.5	125	
SDIS 2.0-5.5						9205550000

Tools

NEW

VDE-insulated screwdriver SlimLine

VDE-insulated screwdriver, for working on live parts up to 1000 V AC and 1500 V DC. DIN EN 60900, IEC 900, "GS safety-tested and each piece tested. Bit made from fully hardened, high-alloy chromium-vanadium-molybdenum steel, gun-metal finish.

A blade that is up to 33 % thinner

The SlimLine design allows you to reach deeply inset fittings and tension clamp terminals.

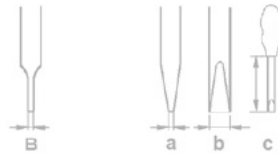
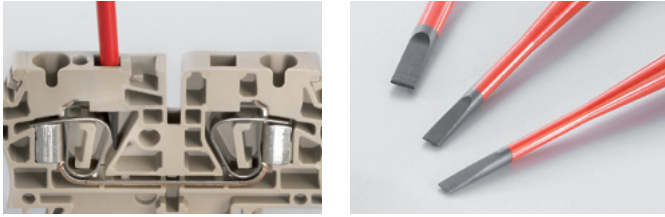

SDI SL S

VDE insulated slot-head screwdriver, SDI SL DIN 7437, ISO 2380/2, drive output acc. to DIN 5264, ISO 2380/1. SoftFinish grip

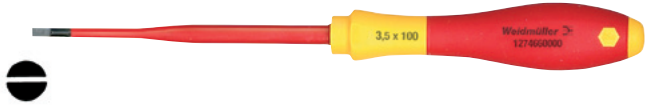

Type	Blade type	Size / AF	a	b	c	Order No.
SDI SL 0.6x3.5x100	B		0.6	3.5	100	1274660000
SDI SL 0.8x4.0x100	B		0.8	4.0	100	1274670000
SDI SL 1.0x4.5x125	B		1.0	4.5	125	1274680000
SDI SL 1.2x6.5x150	B		1.2	6.5	150	1274690000

SDIK SL PH

VDE-insulated crosshead screwdriver, Phillips type, SDIK SL PH DIN 7438, ISO 8764/2-PH, output acc. to ISO 8764-PH, SoftFinish grip



SDIK SL PH1		1		80	1274710000
SDIK SL PH2		2		100	1274720000

SDIK SL PZ

VDE-insulated crosshead screwdriver Pozidrive type, SDIK SL PZ DIN 7438, ISO 8764/2-PZ, output acc. to ISO 8764-PZ, SoftFinish grip



SDIK SL PZ1		1		80	1274730000
SDIK SL PZ2		2		100	1274740000

SDIS SL 2.5-5.5/PH/1/2

6-part set: VDE insulated slotted and crosshead PH screwdriver set



SDI SL 0.6x3.5x100	B		0.6	3.5	100	
SDI SL 0.8x4.0x100	B		0.8	4.0	100	
SDI SL 1.0x4.5x125	B		1.0	4.5	125	
SDI SL 1.2x6.5x150	B		1.2	6.5	150	
SDIK SL PH1		1			80	
SDIK SL PH2		2			100	
SDIS SL 2.5-5.5/PH1/2						1274750000

Uninsulated screwdriver

Weidmüller SoftFinish screwdriver for general use. Blade made from fully hardened, high-alloy chromium-vanadium-molybdenum steel, matt chrome finish.

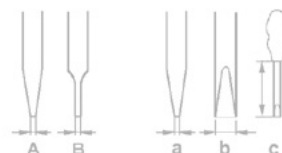

SD S

Slotted screwdriver with rounded blade SD DIN 5265, ISO 2380/2, output to DIN 5264, ISO 2380/1. ChromTop tip, SoftFinish grip



SDK PZ

Crosshead screwdriver, Pozidriv, SDK PZ DIN 5262, ISO 8764/2-PZ, output to ISO 8764/1-PZ, ChromTop tip, SoftFinish grip



SD TH

Torx® TH screwdriver with hole in tip of blade (tamper-resistant), SD TH for screwing Torx® and Torx®-TH security screws (pin in centre of Torx recess), chrome top tip, SoftFinish grip. The SD TH20 can be used with the Klippon K housing series.



SK

The SK 10.0x125 Allen key, SK DIN 3125, drive output acc. to DIN 475/2, SoftFinish grip. It can be used with all sizes from the Klippon TB and Klippon STB housing series.



Type	Blade type	Size / AF	a	b	c	Order No.
SD 0.4x2.0x60	B		0.4	2.0	60	9037160000
SD 0.4x2.5x75	A		0.4	2.5	75	9009030000
SD 0.5x3.0x80	A		0.5	3.0	80	9008320000
SD 0.6x3.5x100	A		0.6	3.5	100	9008330000
SD 0.6x3.5x200	A		0.6	3.5	200	9010110000
SD 0.8x4.0x100	A		0.8	4.0	100	9008340000
SD 0.8x4.5x125	A		0.8	4.5	125	9009020000
SD 1.0x5.5x150	A		1.0	5.5	150	9008350000
SD 1.2x6.5x150	A		1.2	6.5	150	9009010000

SDK PZ0	0	60	9008520000
SDK PZ1	1	80	9008530000
SDK PZ2	2	100	9008540000
SDK PZ3	3	150	9008550000

SD TH20	20	100	9009160000
---------	----	-----	------------

SK 10.0x125	10	125	9009070000
-------------	----	-----	------------

Tools

Weidmüller wrench set

Allen key made from fully hardened, high-alloy chromium-vanadium steel, produced acc. to DIN ISO 2936 L (DIN 911), high-quality refined surface.

SK WSD S

9-piece offset screwdriver set in Prostar holder, with MagicRing: holds standard screws (size 3 and larger) in any position thanks to spring steel ring, with ball point: for working at angles up to 25°.



Type	Blade type	Size / AF	a	b	c	Order No.
		1.5				
		2				
		2.5				
		3				
		4				
		5				
		6				
		8				
		10				
SK WSD-S 1.5-10.0						9008850000

SK S

7-piece Allen key set



	2					
	2.5					
	3					
	4					
	5					
	6					
	8					
SKS 2.0-8.0						9008860000

SK S

7-piece Allen key set with MagicRing and ball point: holds standard screws (size 3 and larger) in any position thanks to spring steel ring, with ball point: for working at angles up to 25°.



	2					
	2.5					
	3					
	4					
	5					
	6					
	8					
SKS 2.0-8.0 MR						9008870000

TH S

8-piece Torx®-TH screwdriver set with hole in the blade point (tamper-proof), for screwing Torx® and Torx®-TH tamper-proof screws (centre pin in profile)



	9					
	10					
	15					
	20					
	25					
	27					
	30					
	40					
TH-S 9-40						9008880000

DMS manual / DMSI manual

Torque screwdrivers with insulation up to 1000 V (VDE) DMSI manual

The "DMSI manual" with an integral window-scale, combined with a Weidmüller 1000 V insulated (VDE) interchangeable blade ensures controlled tightening of screws plus reliability in electrical applications.

Every 1000 V insulated handle (VDE) and blade (VDE) is tested and provides the necessary safety up to 1000 V AC/1500 V DC.



Scale

Torque screwdrivers DMS manual

This is a versatile tool suitable for a variety of jobs, with an integral scale for easy reading of the torque value plus a Weidmüller interchangeable blade.



Each model is available with two torque ranges:

- 0.5 to 1.7 Nm
- 2.0 to 8.0 Nm
- setting tool included

Advantages:

- Compact and especially lightweight design
- Torque set with special tool (included) to ensure the right setting
- Ergonomic handle size to match the torque range
- Every tool checked and given an ID No., 100 % quality control with verification and product reference
- Audible, unmistakable click upon reaching the torque, no unnecessary effort
- Interchangeable blade made from high-quality wear-resistant tool steel
- All tools comply with the accuracy stipulations of: EN ISO 6798, BS EN 26789, ASME B107.14M
- Operating accuracy: ± 6 % of set scale value



Setting tool

Uninsulated torque screwdriver

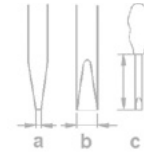

DMS manual

Torque screwdriver EN ISO 6798, BS EN 26789, ASME B107.14M



Type	Size / AF	a	b	c	Order No.
DMS MANUELL 0.5-1.7	0.5 - 1.7 Nm				9918370000
DMS MANUELL 2.0-8.0	2.0 - 8.0 Nm				9918380000

WK K S

Interchangeable bits for torque screwdriver
output acc. to DIN 5264, ISO 2380/1

WK S 0.4x2.5	max. 0.4 Nm	0.4	2.5	175	9918520000
WK S 0.5x3.0	max. 0.6 Nm	0.5	3.0	175	9918530000
WK S 0.6x3.5	max. 1.1 Nm	0.6	3.5	175	9918540000
WK S 0.8x4.0	max. 2.5 Nm	0.8	4.0	175	9918550000
WK S 1.0x5.5	max. 3.8 Nm	1.0	5.5	175	9918560000

WK K PZ

Interchangeable bits for torque screwdriver
output acc. to DIN 5260-PZ, ISO 8764/1-PZ

WK K PZ0	max. 0.9 Nm			175	9918600000
WK K PZ1	max. 3.8 Nm			175	9918610000
WK K PZ2	max. 5.5 Nm			175	9918620000

WK K PH

Interchangeable bits for torque screwdriver
output acc. to DIN 5260-PH, ISO 8764/1-PH

WK K PH0	max. 0.9 Nm			175	9918570000
WK K PH1	max. 3.8 Nm			175	9918580000
WK K PH2	max. 5.5 Nm			175	9918590000

WGK 1/4 C6.3 E6.3

Interchangeable bit with bit holder for torque screwdrivers
Drive: 1/4" C6.3 and 1/4" E6.3

WK 1/4" C6.3 E6.3					9202510000
-------------------	--	--	--	--	------------

Tools

VDE-insulated torque screwdriver

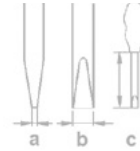

DMSI manual

VDE-insulated torque screwdriver
EN ISO 6798, BS EN 26789, ASME B107.14M



Type	Size / AF	a	b	c	Order No.
DMSI MANUELL 0.5-1.7	0.5 - 1.7 Nm				9918390000
DMSI MANUELL 2.0-8.0	2.0 - 8.0 Nm				9918400000

WK SI

VDE-insulated interchangeable bits for VDE-insulated torque screwdriver;
output acc. to DIN 5264, ISO 2380/1



WK SI 0.4x2.5	max. 0.4 Nm	0.4	2.5	220	9918410000
WK SI 0.5x3.0	max. 0.6 Nm	0.5	3.0	220	9918420000
WK SI 0.6x3.5	max. 1.1 Nm	0.6	3.5	220	9918430000
WK SI 0.8x4.0	max. 2.5 Nm	0.8	4.0	220	9918440000
WK SI 1.0x5.5	max. 3.8 Nm	1.0	5.5	220	9918450000

F

WK IK PH

VDE-insulated interchangeable bits for VDE-insulated torque screwdriver;
output acc. to DIN 5260-PH, ISO 8764/1-PH



WK IK PH0	max. 0.9 Nm			220	9918460000
WK IK PH1	max. 3.8 Nm			220	9918470000
WK IK PH2	max. 5.5 Nm			220	9918480000

WK IK PZ

VDE-insulated interchangeable bits for VDE-insulated torque screwdriver;
output acc. to DIN 5260-PZ, ISO 8764/1-PZ



WK IK PZ0	max. 0.9 Nm			220	9918490000
WK IK PZ1	max. 3.8 Nm			220	9918500000
WK IK PZ2	max. 5.5 Nm			220	9918510000

Pin and electrical cabinet key

IS 4 / IS 6 / IS 8

Wrench with pegged pilot tip

Hexagon screwdriver with cross-grip made from high-quality plastics

- Surface nickel-plated
- Made from hardened chromium-vanadium steel
- According to DIN 6911
- Designed for screws acc. to DIN 6912

Ordering data

Type	Blade length (C)	Qty.	Order No.
IS 4 DIN 6911	60	1	0485100000
IS 6 DIN 6911	80	1	0407900000
IS 8 DIN 6911	90	1	0235000000

Technical data

Blade length [C]	60 mm / 80 mm / 90 mm
Weight	34 g



IS 2 KG / IS 3 KG / IS 4 KG

Socket wrench

Hexagon screwdriver with cross-grip made from high-quality plastics

- Surface nickel-plated
- Made from hardened chromium-vanadium steel
- According to DIN 6911
- Designed for screws acc. to DIN 6912

Ordering data

Type	Qty.	Order No.
IS 2 KG	1	1806630000
IS 3 KG	1	1806650000
IS 4 KG	1	1806660000

Technical data

Blade length [C]	100 mm
Weight	32 g



Cross-Key Master

Universal key

- With bit holder and reversible bit (drives - refer to symbols)
- Material: die cast zinc
- Dimensions: 62 x 90 mm
- **Applications:**
For almost all commercial locking systems in buildings including: doors, window handles, radiator bleed valves, sanitary installations, HVAC, gas and water supply.

Ordering data

Type	Qty.	Order No.
CROSS-KEY MASTER	1	9918150000

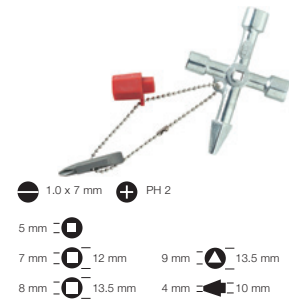

Cross-Key Universal

Universal electrical cabinet key

- With bit holder and reversible bit (drives - refer to symbols)
- Material: die cast zinc
- Dimensions: 72 x 72 mm
- **Applications:**
For locking systems used in electrical engineering, fits all standard electrical cabinet locks.

Ordering data

Type	Qty.	Order No.
CROSS-KEY UNIVERSAL	1	9918130000

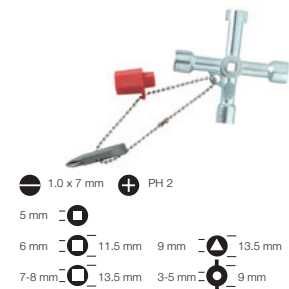

Cross-Key Universal S

Universal mini electrical cabinet key

- With bit holder and reversible bit (drives - refer to symbols)
- Material: die cast zinc
- Dimensions: 42 x 42 mm
- **Applications:**
For locking systems used in electrical engineering, fits all standard electrical cabinet locks.

Ordering data

Type	Qty.	Order No.
CROSS-KEY UNIVERSAL S	1	9918140000

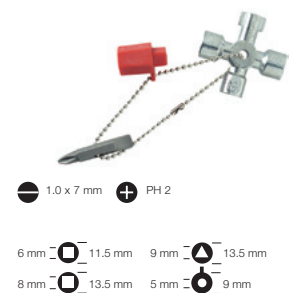

Tools

Rechargeable torque screwdriver

DMS 3

DMS 3 Set



DMS 3 rechargeable torque screwdriver

- One-hand operation under all working conditions
- Switchable forward and reverse
- Two speeds: 200 and 400 rpm
- Precise torque settings from approx. 0.3 ... 3 Nm in 6 steps
- Consistent performance during battery discharge
- Grip swings easily from rod to pistol form
- Takes 1/4" bits held ball-bearing clamping mechanism (form E6.3)
- Safety lock prevents inadvertent operation
- Easy changeover from battery drive to manual operation up to 15 Nm

Technical data

Screwdriver	
Motor	2.4 V DC
Idling speed	200/400 min ⁻¹
Max. torque	3.0 Nm
Chuck	1/4" E 6.3 DIN 3126
Length	239 mm
Weight	400 g
Battery	
Type	2 Ni-Cd batteries each 1.2 V
Weight	122 g
Charger	
Input	230 V AC, 50 Hz, 50 mA
Output	2.9 V AC, 1.4 A, 4.1 VA
Charging time	1 hour
Weight	700 g

Ordering data

Type	Qty.	Order No.
DMS 3	1	9007440000
Screwdriver incl. battery		

Accessories

Type	Qty.	Order No.
Spare battery	1	9007450000
Charger	1	9007460000

Type	Qty.	Order No.
DMS 3 set 1 (screwdriver incl. battery, charger, bits, plastic carrying case)*	1	9007470000
DMS 3 set 2 (as set 1 with 1 additional battery)	1	9007480000

*) see picture

Tools

Tools for insulated cable lugs

Tool	Order No.	Type of contact		
		0.5 - 1.5	1.5 - 2.5	4.0 - 6.0
CTI 6	9006120000	●	●	●
CTI 6 G	9202850000	●	●	●
HTI 15	9014400000	●	●	●
Station		red	blue	yellow

Crimping tools for ferrules

	PZ 1.5	stripax® plus 2.5	PZ 3	PZ 4	PZ 6 roto	PZ 6 HEX	PZ 6/5	PZ 16	PZ 50
Order No.	9005990000	9020000000	0567300000	9012500000	9014350000	9013650000	9011460000	9012600000	9006450000
AEH mm ²									
H 0.14	●				●	●			
H 0.25	●				●	●	●		
H 0.34	●				●	●	●		
H 0.5	●	● ¹	●	●	●	●	●		
H 0.75	●	● ¹	●	●	●	●	●		
H 1.0	●	● ¹	●	●	●	●	●		
H 1.5	●	● ¹	●	●	●	●	●		
H 2.5		● ¹	●	●	●	●	●		
H 4.0			●	●	●	●	●		
H 6.0			●		●	●	●	●	
H 10.0								●	
H 16.0								●	
H 25.0									●
H 35.0									●
H 50.0									●

●¹ = ferrules in strip form only

Twin wire end ferrules are to be crimped according to the following table:

Tool	Order No.	Ferrules								
		H 0.5	H 0.75	H 1.0	H 1.5	H 2.5	H 4.0	H 6.0	H 10.0	H 16.0
PZ 1.5	9005990000	●	●							
PZ 3	0567300000	●	●			●				
PZ 4	9012500000	●	●	●	●	●				
PZ 6 roto	9014350000	●	●	●	●	●	●			
PZ 6/5	9011460000		●	●	●	●	●			
Station		1.5 mm ²	1.5 mm ²	2.5 mm ²	2.5 mm ²	4 mm ²	6 mm ²			
PZ ZH 16	9013600000							●	●	●

Wire end ferrules

Wire end ferrules with plastic collar

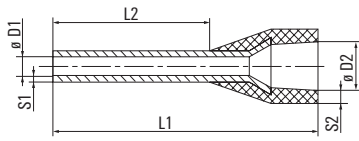

- Polypropylene conical cable entry
- Heat-resistant up to 105 °C
- Cable entry made from non-flammable material on request

For conductors from 0.14 to 150 mm²
(AWG 26-300MCM)
Tin-plated copper
Dimensional tolerances to DIN 46228 part 4

Weidmüller colour code

packed loose



Ordering data

Type	σ mm ²	AWG	L1	L2	D1	D2	S1	S2	Stripping length	Colour	Qty.	Order No.
H0.25/10	0.25	24	10.0	6.0	0.8	1.8	0.15	0.25	8.0	light blue	500	9025740000
H0.25/12	0.25	24	12.0	8.0	0.8	1.8	0.15	0.25	10.0	light blue	500	9025760000
H0.34/10	0.34	22	10.0	6.0	0.8	2.0	0.15	0.25	8.0	turquoise	500	9025750000
H0.34/12	0.34	22	12.0	8.0	0.8	2.0	0.15	0.25	10.0	turquoise	500	9025770000
H0.5/12	0.50	20	12.0	6.0	1.0	2.6	0.15	0.25	8.0	orange	500	0409500000
H0.5/14	0.50	20	14.0	8.0	1.0	2.6	0.15	0.25	10.0	orange	500	0690700000
H0.5/16	0.50	20	16.0	10.0	1.0	2.6	0.15	0.25	12.0	orange	500	9025870000
H0.75/12	0.75	18	12.0	6.0	1.2	2.8	0.15	0.25	8.0	white	500	0409600000
H0.75/14	0.75	18	14.0	8.0	1.2	2.8	0.15	0.25	10.0	white	500	0462900000
H0.75/16	0.75	18	16.0	10.0	1.2	2.8	0.15	0.25	12.0	white	500	9025860000
H0.75/18	0.75	18	18.0	12.0	1.2	2.8	0.15	0.25	14.0	white	500	9025910000
H1.0/12	1.00	17	12.0	6.0	1.4	3.0	0.15	0.25	8.0	yellow	500	0409700000
H1.0/14	1.00	17	14.0	8.0	1.4	3.0	0.15	0.25	10.0	yellow	500	0463000000
H1.0/16	1.00	17	16.0	10.0	1.4	3.0	0.15	0.25	12.0	yellow	500	9025950000
H1.0/18	1.00	17	18.0	12.0	1.4	3.0	0.15	0.25	15.0	yellow	500	9025930000
H1.5/14	1.50	16	14.0	8.0	1.7	3.5	0.15	0.25	10.0	red	500	0463100000
H1.5/16	1.50	16	16.0	10.0	1.7	3.5	0.15	0.25	12.0	red	500	0635100000
H1.5/24	1.50	16	24.0	18.0	1.7	3.5	0.15	0.25	20.0	red	500	0565600000
H2.5/15D	2.50	14	15.0	8.0	2.2	4.2	0.15	0.25	10.0	blue	500	9019160000
H2.5/19D	2.50	14	19.0	12.0	2.2	4.2	0.15	0.25	14.0	blue	500	9019170000
H2.5/25D	2.50	14	25.0	18.0	2.2	4.2	0.15	0.25	20.0	blue	500	9019180000
H4.0/18D	4.00	12	18.0	10.0	2.8	4.8	0.2	0.3	12.0	grey	500	9019190000
H4.0/20D	4.00	12	20.0	12.0	2.8	4.8	0.2	0.3	14.0	grey	500	9019200000
H4.0/26D	4.00	12	26.0	18.0	2.8	4.8	0.2	0.3	20.0	grey	100	9019210000
H6.0/20	6.00	10	20.0	12.0	3.5	6.3	0.2	0.3	14.0	black	100	0533500000
H6.0/26	6.00	10	26.0	18.0	3.5	6.3	0.2	0.3	20.0	black	100	0565700000
H10.0/22	10.00	7	22.0	12.0	4.5	7.6	0.2	0.4	15.0	ivory	100	0534200000
H10.0/28	10.00	7	28.0	18.0	4.5	7.6	0.2	0.4	21.0	ivory	100	0565800000
H16.0/22	16.00	6	22.0	12.0	5.8	8.8	0.2	0.4	15.0	green	100	0565900000
H16.0/28	16.00	6	28.0	18.0	5.8	8.8	0.2	0.4	21.0	green	100	0566000000
H25.0/30	25.00	3	30.0	16.0	7.3	11.2	0.2	0.4	18.0	brown	50	0317000000
H25.0/36	25.00	3	36.0	22.0	7.3	11.2	0.2	0.4	24.0	brown	50	0317100000
H35.0/30	35.00	2	30.0	16.0	8.3	12.7	0.2	0.4	19.0	beige	50	0317200000
H35.0/39	35.00	2	39.0	25.0	8.3	12.7	0.2	0.4	28.0	beige	50	0317300000
H50.0/36	50.00	1	36.0	20.0	10.3	15.0	0.3	0.5	26.0	olive green	50	0444200000
H70.0/37	70.00	2/0	37.0	21.0	12.7	16.0	0.35	0.6	26.0	yellow	25	9028200000
H95.0/44	95.00	3/0	44.0	25.0	14.7	18.0	0.35	0.6	31.0	red	25	9028210000
H120.0/50	120.00	4/0	50.0	30.0	16.5	21.0	0.5	0.7	36.0	blue	25	9028220000
H150.0/54	150.00	300 MCM	54.0	32.0	18.5	23.5	0.5	0.75	38.0	yellow	25	9028230000

Weidmüller colour code

in multipack bag



Ordering data

Type	σ mm ²	AWG	L1	L2	D1	D2	S1	S2	Stripping length	Colour	Qty.	Order No.
H0.14/10	0.14	26	10.0	6.0	0.6	1.5	0.15	0.25	8.0	grey	500	9005180000
H0.14/12	0.14	26	12.0	8.0	0.6	1.5	0.15	0.25	10.0	grey	500	9028240000
H0.25/10	0.25	24	10.0	6.0	0.8	1.8	0.15	0.25	8.0	light blue	500	9026050000
H0.25/12	0.25	24	12.0	8.0	0.8	1.8	0.15	0.25	10.0	light blue	500	9025780000
H0.34/10	0.34	22	10.0	6.0	0.8	2.0	0.15	0.25	8.0	turquoise	500	9026030000
H0.34/12	0.34	22	12.0	8.0	0.8	2.0	0.15	0.25	10.0	turquoise	500	9025790000
H0.5/12	0.50	20	12.0	6.0	1.0	2.6	0.15	0.25	8.0	orange	500	9028260000
H0.5/14	0.50	20	14.0	8.0	1.0	2.6	0.15	0.25	10.0	orange	500	9026060000
H0.5/16	0.50	20	16.0	10.0	1.0	2.6	0.15	0.25	12.0	orange	500	9028270000
H0.75/12	0.75	18	12.0	6.0	1.2	2.8	0.15	0.25	8.0	white	500	9028280000
H0.75/14	0.75	18	14.0	8.0	1.2	2.8	0.15	0.25	10.0	white	500	9026070000
H0.75/16	0.75	18	16.0	10.0	1.2	2.8	0.15	0.25	12.0	white	500	9028290000
H0.75/18	0.75	18	18.0	12.0	1.2	2.8	0.15	0.25	14.0	white	500	9028300000
H1.0/12	1.00	17	12.0	6.0	1.4	3.0	0.15	0.25	8.0	yellow	500	9028310000
H1.0/14	1.00	17	14.0	8.0	1.4	3.0	0.15	0.25	10.0	yellow	500	9026080000
H1.0/16	1.00	17	16.0	10.0	1.4	3.0	0.15	0.25	12.0	yellow	500	9028320000
H1.0/18	1.00	17	18.0	12.0	1.4	3.0	0.15	0.25	15.0	yellow	500	9028340000
H1.5/14	1.50	16	14.0	8.0	1.7	3.5	0.15	0.25	10.0	red	500	9026090000
H1.5/16	1.50	16	16.0	10.0	1.7	3.5	0.15	0.25	12.0	red	500	9028350000
H2.5/15	2.50	14	15.0	8.0	2.2	4.2	0.15	0.25	10.0	blue	500	9026100000
H4.0/18	4.00	12	18.0	10.0	2.8	4.8	0.2	0.3	12.0	grey	250	9026010000

Wire end ferrules with plastic collar

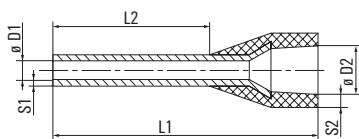

- Polypropylene conical cable entry
- Heat-resistant up to 105 °C
- Cable entry made from a non-flammable material on request

For conductors from 0.5 to 2.5 mm² (AWG 22-14)
 Tin-plated copper
 Dimensional tolerances to DIN 46228 part 4

Weidmüller colour code

Strip of wire end ferrules



Ordering data

Type	Ø mm ²	AWG	L1	L2	D1	D2	S1	S2	Stripping length	Colour	Qty.	Order No.
H0.5/14	0.50	20	14.0	8.0	1.0	2.6	0.15	0.25	10.0	orange	500	9004270000
H0.75/14	0.75	18	14.0	8.0	1.2	2.8	0.15	0.25	10.0	white	500	9004290000
H1.0/14	1.00	17	14.0	8.0	1.4	3.0	0.15	0.25	10.0	yellow	500	9004320000
H1.5/14	1.50	16	14.0	8.0	1.7	3.2	0.15	0.25	10.0	red	500	9004340000
H2.5/14D	2.50	14	14.0	8.0	2.2	4.0	0.15	0.25	11.0	blue	500	9004360000

Weidmüller colour code

Reel of wire end ferrules



Ordering data

Type	Ø mm ²	AWG	L1	L2	D1	D2	S1	S2	Stripping length	Colour	Qty.	Order No.
H0.34/12	0.34	22	12.0	8.0	0.8	2.0	0.15	0.25	10.0	turquoise	5000	9004390000
H0.5/14	0.50	20	14.0	8.0	1.0	2.6	0.15	0.25	10.0	orange	5000	9005810000
H0.75/14	0.75	18	14.0	8.0	1.2	2.8	0.15	0.25	10.0	white	5000	9005820000
H1.0/14	1.00	17	14.0	8.0	1.4	3.0	0.15	0.25	11.0	yellow	5000	9005830000
H1.5/14	1.50	16	14.0	8.0	1.7	3.2	0.15	0.25	10.0	red	5000	9005840000
H2.5/14D	2.50	14	14.0	8.0	2.2	4.0	0.15	0.25	11.0	blue	3000	9005850000

Wire end ferrules

Wire end ferrules with plastic collar

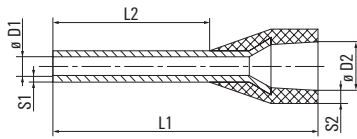

- Polypropylene conical cable entry
- Heat-resistant up to 105 °C
- Cable entry made from a non-flammable material on request

For conductors from 0.5 to 50 mm² (AWG 20-1)
 Tin-plated copper
 Dimensional tolerances to DIN 46228 part 4

DIN colour code

packed loose



Ordering data

Type	Ø mm ²	AWG	L1	L2	D1	D2	S1	S2	Stripping length	Colour	VG*	Qty.	Order No.
H0.5/12D	0.50	20	12.0	6.0	1.0	2.6	0.15	0.25	8.0	○ white	T 20A 001 A	500	9019000000
H0.5/14D	0.50	20	14.0	8.0	1.0	2.6	0.15	0.25	10.0	○ white	T 20A 002 A	500	9019010000
H0.5/16D	0.50	20	16.0	10.0	1.0	2.6	0.15	0.25	12.0	○ white	T 20A 003 A	500	9019020000
H0.75/12D	0.75	18	12.0	6.0	1.2	2.8	0.15	0.25	8.0	● grey	T 20A 004 A	500	9019030000
H0.75/14D	0.75	18	14.0	8.0	1.2	2.8	0.15	0.25	10.0	● grey	T 20A 005 A	500	9019040000
H0.75/16D	0.75	18	16.0	10.0	1.2	2.8	0.15	0.25	12.0	● grey	T 20A 006 A	500	9019050000
H0.75/18D	0.75	18	18.0	12.0	1.2	2.8	0.15	0.25	14.0	● grey	T 20A 007 A	500	9019060000
H1.0/12D	1.00	17	12.0	6.0	1.4	3.0	0.15	0.25	8.0	● red	T 20A 008 A	500	9019070000
H1.0/14D	1.00	17	14.0	8.0	1.4	3.0	0.15	0.25	10.0	● red	T 20A 009 A	500	9019080000
H1.0/16D	1.00	17	16.0	10.0	1.4	3.0	0.15	0.25	12.0	● red	T 20A 010 A	500	9019100000
H1.0/18D	1.00	17	18.0	12.0	1.4	3.0	0.15	0.25	15.0	● red	T 20A 011 A	500	9019110000
H1.5/14D	1.50	16	14.0	8.0	1.7	3.5	0.15	0.25	10.0	● black	T 20A 012 A	500	9019120000
H1.5/16D	1.50	16	16.0	10.0	1.7	3.5	0.15	0.25	12.0	● black	T 20A 013 A	500	9019130000
H1.5/18D	1.50	16	18.0	12.0	1.7	3.5	0.15	0.25	15.0	● black	T 20A 014 A	500	9019140000
H1.5/24D	1.50	16	24.0	18.0	1.7	3.5	0.15	0.25	20.0	● black	T 20A 015 A	500	9019150000
H2.5/15D	2.50	14	15.0	8.0	2.2	4.2	0.15	0.25	10.0	● blue	T 20A 016 A	500	9019160000
H2.5/19D	2.50	14	19.0	12.0	2.2	4.2	0.15	0.25	14.0	● blue	T 20A 017 A	500	9019170000
H2.5/25D	2.50	14	25.0	18.0	2.2	4.2	0.15	0.25	20.0	● blue	T 20A 018 A	500	9019180000
H4.0/18D	4.00	12	18.0	10.0	2.8	4.8	0.2	0.3	12.0	● grey	T 20A 019 A	500	9019190000
H4.0/20D	4.00	12	20.0	12.0	2.8	4.8	0.2	0.3	14.0	● grey	T 20A 020 A	500	9019200000
H4.0/26D	4.00	12	26.0	18.0	2.8	4.8	0.2	0.3	20.0	● grey	T 20A 021 A	100	9019210000
H6.0/20D	6.00	10	20.0	12.0	3.5	6.3	0.2	0.3	14.0	● yellow	T 20A 022 A	100	9019220000
H6.0/26D	6.00	10	26.0	18.0	3.5	6.3	0.2	0.3	20.0	● yellow	T 20A 023 A	100	9019230000
H10.0/22D	10.00	7	22.0	12.0	4.5	7.6	0.2	0.4	15.0	● red	T 20A 024 A	100	9019240000
H10.0/28D	10.00	7	28.0	18.0	4.5	7.6	0.2	0.4	21.0	● red	T 20A 025 A	100	9019250000
H16.0/22D	16.00	6	22.0	12.0	5.8	8.8	0.2	0.4	15.0	● blue	T 20A 026 A	100	9019260000
H16.0/28D	16.00	6	28.0	18.0	5.8	8.8	0.2	0.4	21.0	● blue	T 20A 027 A	100	9019270000
H25.0/30D	25.00	3	30.0	16.0	7.3	11.2	0.2	0.4	18.0	● yellow	T 20A 028 A	50	9019280000
H25.0/36D	25.00	3	36.0	22.0	7.3	11.2	0.2	0.4	24.0	● yellow	T 20A 030 A	50	9019300000
H35.0/32D	35.00	2	32.0	18.0	8.3	12.7	0.2	0.4	21.0	● red	T 20A 032 A	50	9019320000
H35.0/30D	35.00	2	30.0	16.0	8.3	12.7	0.2	0.4	19.0	● red	T 20A 031 A	50	9019310000
H35.0/39D	35.00	2	39.0	25.0	8.3	12.7	0.2	0.4	28.0	● red	T 20A 033 A	50	9019330000
H50.0/36D	50.00	1	36.0	20.0	10.3	15.0	0.3	0.5	26.0	● blue	T 20A 034 A	50	9019340000
H50.0/41D	50.00	1	41.0	25.0	10.3	15.0	0.3	0.5	31.0	● blue	T 20A 035 A	50	9019350000

DIN colour code

in multipack bag



Ordering data

Type	Ø mm ²	AWG	L1	L2	D1	D2	S1	S2	Stripping length	Colour	VG*	Qty.	Order No.
H0.5/14D	0.50	20	14.0	8.0	1.0	2.6	0.15	0.25	10.0	○ white	T 20A 002 A	500	9019400000
H0.75/14D	0.75	18	14.0	8.0	1.2	2.8	0.15	0.25	10.0	● grey	T 20A 005 A	500	9019410000
H1.0/14D	1.00	17	14.0	8.0	1.4	3.0	0.15	0.25	10.0	● red	T 20A 009 A	500	9019420000
H1.5/14D	1.50	16	14.0	8.0	1.7	3.5	0.15	0.25	10.0	● black	T 20A 012 A	500	9019430000
H2.5/15	2.50	14	15.0	8.0	2.2	4.2	0.15	0.25	10.0	● blue	T 20A 016 A	500	9026100000
H4.0/18	4.00	12	18.0	10.0	2.8	4.8	0.2	0.3	12.0	● grey	019 A	250	9026010000

DIN colour code

Strip of wire end ferrules



Ordering data

Type	Ø mm ²	AWG	L1	L2	D1	D2	S1	S2	Stripping length	Colour	VG*	Qty.	Order No.
H0.5/14D	0.50	20	14.0	8.0	1.0	2.6	0.15	0.25	10.0	○ white	T 20A 002 A	500	9004280000
H0.75/14D	0.75	18	14.0	8.0	1.2	2.8	0.15	0.25	10.0	● grey	T 20A 005 A	500	9004300000
H1.0/14D	1.00	17	14.0	8.0	1.4	3.0	0.15	0.25	10.0	● red	T 20A 009 A	500	9004330000
H1.5/14D	1.50	16	14.0	8.0	1.7	3.2	0.15	0.25	10.0	● black	T 20A 012 A	500	9004350000
H2.5/14D	2.50	14	14.0	8.0	2.2	4.0	0.15	0.25	11.0	● blue	T 20A 016 A	500	9004360000

VG* = Military designation according to VG 96933-20

Wire end ferrules with plastic collar

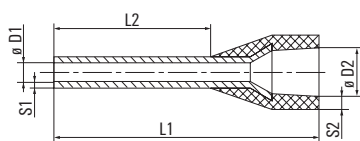

- Polypropylene conical cable entry
- Heat-resistant up to 105 °C
- Cable entry made from a non-flammable material on request

For conductors from 0.5 to 2.5 mm² (AWG 20-14)
Tin-plated copper
Dimensional tolerances to DIN 46228 part 4

DIN colour code

Reel of wire end ferrules



Ordering data

Type	Ø mm ²	AWG	L1	L2	D1	D2	S1	S2	Stripping length	Colour	VG*	Qty.	Order No.
H0.5/14D	0.50	20	14.0	8.0	1.0	2.6	0.15	0.25	10.0	○ white		5000	9005860000
H0.75/14D	0.75	18	14.0	8.0	1.2	2.8	0.15	0.25	10.0	● grey		5000	9005870000
H1.0/14D	1.00	17	14.0	8.0	1.4	3.0	0.15	0.25	11.0	● red		5000	9005880000
H1.5/14D	1.50	16	14.0	8.0	1.7	3.2	0.15	0.25	10.0	● black		5000	9005890000
H2.5/14D	2.50	14	14.0	8.0	2.2	4.0	0.15	0.25	11.0	● blue		3000	9005850000

Wire end ferrules

Wire end ferrules with plastic collar

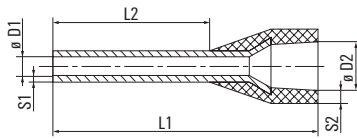

- Polypropylene conical cable entry
- Heat-resistant up to 105 °C
- Cable entry made from a non-flammable material on request

For conductors from 0.14 to 25 mm² (AWG 26-3)
Tin-plated copper
Dimensional tolerances to DIN 46228 part 4

other colour code

packed loose



Ordering data

Type	σ mm ²	AWG	L1	L2	D1	D2	S1	S2	Stripping length	Colour	Qty.	Order No.
H0.25/10T	0.25	24	10.0	6.0	0.8	1.8	0.15	0.25	8.0	● yellow	500	9021010000
H0.25/12T	0.25	24	12.0	8.0	0.8	1.8	0.15	0.25	10.0	● yellow	500	9021020000
H0.5/12D	0.50	20	12.0	6.0	1.0	2.6	0.15	0.25	8.0	○ white	500	9019000000
H0.5/14D	0.50	20	14.0	8.0	1.0	2.6	0.15	0.25	10.0	○ white	500	9019010000
H0.5/16D	0.50	20	16.0	10.0	1.0	2.6	0.15	0.25	12.0	○ white	500	9019020000
H0.75/12T	0.75	18	12.0	6.0	1.2	2.8	0.15	0.25	8.0	● light blue	500	9021030000
H0.75/14	0.75	18	14.0	8.0	1.2	2.8	0.15	0.25	10.0	● light blue	500	9021040000
H0.75/16T	0.75	18	16.0	10.0	1.2	2.8	0.15	0.25	12.0	● light blue	500	9021050000
H0.75/18T	0.75	18	18.0	12.0	1.2	2.8	0.15	0.25	14.0	● light blue	500	9021060000
H1.0/12D	1.00	17	12.0	6.0	1.4	3.0	0.15	0.25	8.0	● red	500	9019070000
H1.0/14D	1.00	17	14.0	8.0	1.4	3.0	0.15	0.25	10.0	● red	500	9019080000
H1.0/16D	1.00	17	16.0	10.0	1.4	3.0	0.15	0.25	12.0	● red	500	9019100000
H1.0/18D	1.00	17	18.0	12.0	1.4	3.0	0.15	0.25	15.0	● red	500	9019110000
H1.5/14D	1.50	16	14.0	8.0	1.7	3.5	0.15	0.25	10.0	● black	500	9019120000
H1.5/16D	1.50	16	16.0	10.0	1.7	3.5	0.15	0.25	12.0	● black	500	9019130000
H1.5/18D	1.50	16	18.0	12.0	1.7	3.5	0.15	0.25	15.0	● black	500	9019140000
H1.5/24D	1.50	16	24.0	18.0	1.7	3.5	0.15	0.25	20.0	● black	500	9019150000
H2.5/15T	2.50	14	15.0	8.0	2.2	4.2	0.15	0.25	10.0	● grey	500	9021070000
H2.5/19T	2.50	14	19.0	12.0	2.2	4.2	0.15	0.25	14.0	● grey	500	9021080000
H2.5/25T	2.50	14	25.0	18.0	2.2	4.2	0.15	0.25	20.0	● grey	500	9021090000
H4.0/18T	4.00	12	18.0	10.0	2.8	4.8	0.2	0.3	12.0	● orange	500	9021100000
H4.0/20T	4.00	12	20.0	12.0	2.8	4.8	0.2	0.3	14.0	● orange	500	9021110000
H4.0/26T	4.00	12	26.0	18.0	2.8	4.8	0.2	0.3	20.0	● orange	100	9021120000
H6.0/20T	6.00	10	20.0	12.0	3.5	6.3	0.2	0.3	14.0	● green	100	9021130000
H6.0/26T	6.00	10	26.0	18.0	3.5	6.3	0.2	0.3	20.0	● green	100	9021140000
H10.0/22T	10.00	7	22.0	12.0	4.5	7.6	0.2	0.4	15.0	● brown	100	9021150000
H10.0/28T	10.00	7	28.0	18.0	4.5	7.6	0.2	0.4	21.0	● brown	100	9021160000
H16.0/22T	16.00	6	22.0	12.0	5.8	8.8	0.2	0.4	15.0	○ white	100	9021170000
H16.0/28T	16.00	6	28.0	18.0	5.8	8.8	0.2	0.4	21.0	○ white	100	9021180000
H25.0/30T	25.00	3	30.0	16.0	7.3	11.2	0.2	0.4	18.0	● black	50	9021190000
H25.0/36T	25.00	3	36.0	22.0	7.3	11.2	0.2	0.4	24.0	● black	50	9021200000

other colour code

in multipack bag



Ordering data

Type	σ mm ²	AWG	L1	L2	D1	D2	S1	S2	Stripping length	Colour	Qty.	Order No.
H0.14/10T	0.14	26	10.0	6.0	0.6	1.5	0.15	0.25	8.0	● brown	500	9028250000
H0.25/10T	0.25	24	10.0	6.0	0.8	1.8	0.15	0.25	8.0	● yellow	500	9021210000
H0.25/12T	0.25	24	12.0	8.0	0.8	1.8	0.15	0.25	10.0	● yellow	500	9021220000
H0.5/14D	0.50	20	14.0	8.0	1.0	2.6	0.15	0.25	10.0	○ white	500	9019400000
H0.75/14T	0.75	18	14.0	8.0	1.2	2.8	0.15	0.25	10.0	● light blue	500	9021230000
H1.0/14D	1.00	17	14.0	8.0	1.4	3.0	0.15	0.25	10.0	● red	500	9019420000
H1.5/14D	1.50	16	14.0	8.0	1.7	3.5	0.15	0.25	10.0	● black	500	9019430000
H1.5/24D	1.50	16	24.0	18.0	1.7	3.5	0.15	0.25	20.0	● black	500	9004140000
H2.5/15T	2.50	14	15.0	8.0	2.2	4.2	0.15	0.25	10.0	● grey	500	9021240000
H4.0/18T	4.00	12	18.0	10.0	2.8	4.8	0.2	0.3	12.0	● orange	250	9021250000

other colour code

Strip of wire end ferrules



Ordering data

Type	σ mm ²	AWG	L1	L2	D1	D2	S1	S2	Stripping length	Colour	Qty.	Order No.
H0.5/14D	0.50	20	14.0	8.0	1.0	2.6	0.15	0.25	10.0	○ white	500	9004280000
H0.75/14T	0.75	18	14.0	8.0	1.2	2.8	0.15	0.25	10.0	● light blue	500	9004310000
H1.0/14D	1.00	17	14.0	8.0	1.4	3.0	0.15	0.25	10.0	● red	500	9004330000
H1.5/14D	1.50	16	14.0	8.0	1.7	3.2	0.15	0.25	10.0	● black	500	9004350000
H2.5/14T	2.50	14	14.0	8.0	2.2	4.0	0.15	0.25	11.0	● grey	500	9004370000

Wire end ferrules with plastic collar

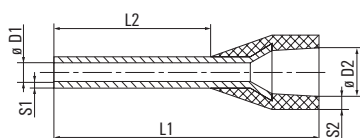

- Polypropylene conical cable entry
- Heat-resistant up to 105 °C
- Cable entry made from a non-flammable material on request

For conductors from 0.5 to 2.5 mm² (AWG 20-14)
Tin-plated copper
Dimensional tolerances to DIN 46228 part 4

other colour code

Reel of wire end ferrules



Ordering data

Type	σ mm ²	AWG	L1	L2	D1	D2	S1	S2	Stripping length	Colour	Qty.	Order No.
H0.5/14D	0.50	20	14.0	8.0	1.0	2.6	0.15	0.25	10.0	○ white	5000	9005860000
H0.75/14T	0.75	18	14.0	8.0	1.2	2.8	0.15	0.25	10.0	● light blue	5000	9005900000
H1.0/14D	1.00	17	14.0	8.0	1.4	3.0	0.15	0.25	11.0	● red	5000	9005880000
H1.5/14D	1.50	16	14.0	8.0	1.7	3.2	0.15	0.25	10.0	● black	5000	9005890000
H2.5/14T	2.50	14	14.0	8.0	2.2	4.0	0.15	0.25	11.0	● grey	3000	9005910000

Wire end ferrules

Twin-wire end ferrules with plastic collar

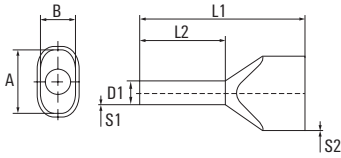

- Polypropylene conical cable entry
- Heat-resistant up to 105 °C
- Cable entry made from a non-flammable material on request

For conductors from 2 No. 0.5 to 2 No. 16 mm²
(2 No. AWG 20 to 2 No. AWG 6)
Tin-plated copper
Dimensional tolerances to DIN 46228 part 4

Weidmüller colour code

packed loose



Ordering data

Type	ø mm ²	AWG	L1	L2	D1	S1	S2	A	B	Stripping length	Colour	Qty.	Order No.
H0.5/14	0.50	20	14.0	8.0	1.4	0.15	0.3	5.0	3.0	11.0	● orange	500	9037200000
H0.5/16	0.50	20	16.0	10.0	1.4	0.15	0.3	5.0	3.0	13.0	● orange	500	9037210000
H0.5/18	0.50	20	18.0	12.0	1.4	0.15	0.3	5.0	3.0	15.0	● orange	500	9037220000
H0.75/14	0.75	18	14.0	8.0	1.7	0.15	0.3	5.5	3.0	11.0	○ white	500	9037230000
H0.75/16	0.75	18	16.0	10.0	1.7	0.15	0.3	5.5	3.0	13.0	○ white	500	9037240000
H0.75/19S	0.75	18	19.0	12.0	1.4	0.15	0.3	5.5	3.0	21.0	○ white	500	9202820000
H0.75/24	0.75	18	24.0	18.0	1.7	0.15	0.3	5.5	3.0	21.0	○ white	500	9037250000
H1.0/15	1.00	17	15.0	8.0	2.0	0.15	0.3	5.8	3.2	12.0	● yellow	500	9037260000
H1.0/15S	1.00	17	16.0	8.0	2.2	0.15	0.3	5.8	3.2	12.0	○ yellow	500	9018690000
H1.0/19	1.00	17	19.0	12.0	2.0	0.15	0.3	5.8	3.2	16.0	● yellow	500	9037270000
H1.0/25	1.00	17	25.0	18.0	2.0	0.15	0.3	5.8	3.2	22.0	● yellow	500	9037280000
H1.5/16	1.50	16	16.0	8.2	2.2	0.15	0.3	6.5	3.6	11.0	● red	500	9037290000
H1.5/20	1.50	16	20.0	12.0	2.2	0.15	0.3	6.5	3.6	15.0	● red	500	9037300000
H1.5/26	1.50	16	26.0	18.0	2.2	0.15	0.3	6.5	3.6	21.0	● red	100	9037310000
H2.5/19D	2.50	14	19.0	10.0	2.8	0.15	0.4	8.0	4.5	13.0	● blue	500	9037500000
H2.5/21D	2.50	14	21.0	12.0	2.8	0.15	0.4	8.0	4.5	15.0	● blue	100	9037510000
H2.5/27D	2.50	14	27.0	18.0	2.8	0.15	0.4	8.0	4.5	21.0	● blue	100	9037520000
H4.0/22D	4.00	12	22.0	12.0	3.5	0.2	0.5	9.0	5.2	15.0	● grey	100	9037530000
H4.0/28D	4.00	12	28.0	18.0	3.5	0.2	0.5	9.0	5.2	21.0	● grey	100	9037540000
H6.0/23	6.00	10	23.0	12.0	4.5	0.2	0.5	11.4	6.2	20.0	● black	100	9037320000
H6.0/29	6.00	10	29.0	18.0	4.5	0.2	0.5	11.4	6.2	24.0	● black	100	9037330000
H10.0/24S	10.00	7	24.0	12.0	6.5	0.2	0.5	13.4	7.6	17.0	● ivory	100	9018860000
H10.0/24	10.00	7	24.0	12.0	5.8	0.2	0.5	13.4	7.6	17.0	● ivory	100	9037340000
H10.0/30	10.00	7	30.0	18.0	5.8	0.2	0.5	13.4	7.6	23.0	● ivory	100	9037350000
H10.0/30S	10.00	7	30.0	18.0	6.5	0.2	0.5	13.4	7.6	23.0	● ivory	100	9018870000
H16.0/29	16.00	6	29.0	16.0	8.3	0.3	0.6	17.2	9.5	20.0	● green	50	9037360000
H16.0/38	16.00	6	38.0	25.0	8.3	0.3	0.6	17.2	9.5	29.0	● green	50	9037370000

Weidmüller colour code

in multipack bag



Ordering data

Type	ø mm ²	AWG	L1	L2	D1	S1	S2	A	B	Stripping length	Colour	Qty.	Order No.
H0.5/14	0.50	20	14.0	8.0	1.4	0.15	0.3	5.0	3.0	11.0	● orange	500	9004440000
H0.75/14	0.75	18	14.0	8.0	1.7	0.15	0.3	5.5	3.0	11.0	○ white	500	9018510000
H0.75/16	0.75	18	16.0	10.0	1.7	0.15	0.3	5.5	3.0	13.0	○ white	500	9004900000
H1.0/15	1.00	17	15.0	8.0	2.0	0.15	0.3	5.8	3.2	12.0	● yellow	500	9018530000
H1.0/15S	1.00	17	16.0	8.0	2.2	0.15	0.3	5.8	3.2	12.0	○ yellow	500	9018650000
H1.0/19	1.00	17	19.0	12.0	2.0	0.15	0.3	5.8	3.2	16.0	● yellow	500	9004910000
H1.5/16	1.50	16	16.0	8.2	2.2	0.15	0.3	6.5	3.6	11.0	● red	500	9004410000
H1.5/20	1.50	16	20.0	12.0	2.2	0.15	0.3	6.5	3.6	15.0	● red	500	9004920000
H2.5/19D	2.50	14	19.0	10.0	2.8	0.15	0.4	8.0	4.5	13.0	● blue	250	9004430000
H2.5/21D	2.50	14	21.0	12.0	2.8	0.15	0.4	8.0	4.5	15.0	● blue	250	9004740000
H4.0/22D	4.00	12	22.0	12.0	3.5	0.2	0.5	9.0	5.2	15.0	● grey	100	9004730000
H6.0/23	6.00	10	23.0	12.0	4.5	0.2	0.5	11.4	6.2	20.0	● black	100	9004930000
H10.0/24	10.00	7	24.0	12.0	5.8	0.2	0.5	13.4	7.6	17.0	● ivory	100	9004940000

Twin-wire end ferrules with plastic collar

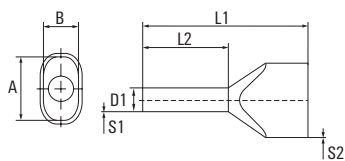

- Polypropylene conical cable entry
- Heat-resistant up to 105 °C
- Cable entry made from a non-flammable material on request

For conductors from 2 No. 0.5 to 2 No. 16 mm²
(2 No. AWG 20 to 2 No. AWG 6)
Tin-plated copper
Dimensional tolerances to DIN 46228 part 4

DIN colour code

packed loose



Ordering data

Type	ø mm ²	AWG	L1	L2	D1	S1	S2	A	B	Stripping length	Colour	Qty.	Order No.
H0.5/14D	0.50	20	14.0	8.0	1.4	0.15	0.3	5.0	3.0	11.0	○ white	500	9037380000
H0.5/16D	0.50	20	16.0	10.0	1.4	0.15	0.3	5.0	3.0	13.0	○ white	500	9037390000
H0.5/18D	0.50	20	18.0	12.0	1.4	0.15	0.3	5.0	3.0	15.0	○ white	500	9037400000
H0.75/14D	0.75	18	14.0	8.0	1.7	0.15	0.3	5.5	3.0	11.0	● grey	500	9037410000
H0.75/16D	0.75	18	16.0	10.0	1.7	0.15	0.3	5.5	3.0	13.0	● grey	500	9037420000
H0.75/19DS	0.75	18	19.0	12.0	1.4	0.15	0.3	5.5	3.0	21.0	● grey	500	9202830000
H0.75/24D	0.75	18	24.0	18.0	1.7	0.15	0.3	5.5	3.0	21.0	● grey	500	9037430000
H1.0/15D	1.00	17	15.0	8.0	2.0	0.15	0.3	5.8	3.2	12.0	● red	500	9037440000
H1.0/19D	1.00	17	19.0	12.0	2.0	0.15	0.3	5.8	3.2	16.0	● red	500	9037450000
H1.0/25D	1.00	17	25.0	18.0	2.0	0.15	0.3	5.8	3.2	22.0	● red	500	9037460000
H1.5/16D	1.50	16	16.0	8.0	2.2	0.15	0.3	6.5	3.6	11.0	● black	500	9037470000
H1.5/20D	1.50	16	20.0	12.0	2.2	0.15	0.3	6.5	3.6	15.0	● black	500	9037480000
H1.5/26D	1.50	16	26.0	18.0	2.2	0.15	0.3	6.5	3.6	21.0	● black	100	9037490000
H2.5/19D	2.50	14	19.0	10.0	2.8	0.15	0.4	8.0	4.5	13.0	● blue	500	9037500000
H2.5/21D	2.50	14	21.0	12.0	2.8	0.15	0.4	8.0	4.5	15.0	● blue	100	9037510000
H2.5/27D	2.50	14	27.0	18.0	2.8	0.15	0.4	8.0	4.5	21.0	● blue	100	9037520000
H4.0/22D	4.00	12	22.0	12.0	3.5	0.2	0.5	9.0	5.2	15.0	● grey	100	9037530000
H4.0/28D	4.00	12	28.0	18.0	3.5	0.2	0.5	9.0	5.2	21.0	● grey	100	9037540000
H6.0/23D	6.00	10	23.0	12.0	4.5	0.2	0.5	11.4	6.2	20.0	● yellow	100	9037550000
H6.0/29D	6.00	10	29.0	18.0	4.5	0.2	0.5	11.4	6.2	24.0	● yellow	100	9037560000
H10.0/24DS	10.00	7	24.0	12.0	6.5	0.2	0.5	13.4	7.6	17.0	● red	100	9018880000
H10.0/24D	10.00	7	24.0	12.0	5.8	0.2	0.5	13.4	7.6	17.0	● red	100	9037570000
H10.0/30D	10.00	7	30.0	18.0	5.8	0.2	0.5	13.4	7.6	23.0	● red	100	9037580000
H10.0/30DS	10.00	7	30.0	18.0	6.5	0.2	0.5	13.4	7.6	23.0	● red	100	9018890000
H16.0/29D	16.00	6	29.0	16.0	8.3	0.3	0.6	17.2	9.5	20.0	● blue	50	9037590000
H16.0/38D	16.00	6	38.0	25.0	8.3	0.3	0.6	17.2	9.5	29.0	● blue	50	9037600000

DIN colour code

in multipack bag



Ordering data

Type	ø mm ²	AWG	L1	L2	D1	S1	S2	A	B	Stripping length	Colour	Qty.	Order No.
H0.5/14D	0.50	20	14.0	8.0	1.4	0.15	0.3	5.0	3.0	11.0	○ white	500	9004780000
H0.75/14D	0.75	18	14.0	8.0	1.7	0.15	0.3	5.5	3.0	11.0	● grey	500	9018520000
H0.75/16D	0.75	18	16.0	10.0	1.7	0.15	0.3	5.5	3.0	13.0	● grey	500	9004770000
H1.0/15D	1.00	17	16.0	8.0	2.0	0.15	0.3	5.8	3.2	12.0	● red	500	9018540000
H1.0/19D	1.00	17	19.0	12.0	2.0	0.15	0.3	5.8	3.2	16.0	● red	500	9004760000
H1.5/16D	1.50	16	16.0	8.0	2.2	0.15	0.3	6.5	3.6	11.0	● black	500	9004420000
H1.5/20D	1.50	16	20.0	12.0	2.2	0.15	0.3	6.5	3.6	15.0	● black	500	9004750000
H2.5/19D	2.50	14	19.0	10.0	2.8	0.15	0.4	8.0	4.5	13.0	● blue	250	9004430000
H2.5/21D	2.50	14	21.0	12.0	2.8	0.15	0.4	8.0	4.5	15.0	● blue	250	9004740000
H4.0/22D	4.00	12	22.0	12.0	3.5	0.2	0.5	9.0	5.2	15.0	● grey	100	9004730000
H6.0/23D	6.00	10	23.0	12.0	4.5	0.2	0.5	11.4	6.2	20.0	● yellow	100	9004720000
H10.0/26D	10.00	7	24.0	12.0	5.8	0.2	0.5	13.4	7.6	17.0	● red	100	9004710000

Wire end ferrules

Twin-wire end ferrules with plastic collar

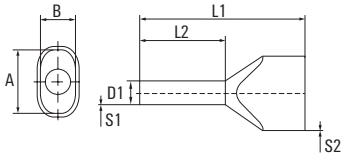

- Polypropylene conical cable entry
- Heat-resistant up to 105 °C
- Cable entry madefrom a non-flammable material on request

For conductors from 2 No. 0.5 to 2 No. 16 mm²
(2 No. AWG 20 to 2 No. AWG 6)
Tin-plated copper
Dimensional tolerances to DIN 46228 part 4

other colour code

packed loose



Ordering data

Type	ø mm ²	AWG	L1	L2	D1	S1	S2	A	B	Stripping length	Colour	Qty.	Order No.
H0.5/14	0.50	20	14.0	8.0	1.4	0.15	0.3	5.0	3.0	11.0	● orange	500	9037200000
H0.5/16	0.50	20	16.0	10.0	1.4	0.15	0.3	5.0	3.0	13.0	● orange	500	9037210000
H0.5/18	0.50	20	18.0	12.0	1.4	0.15	0.3	5.0	3.0	15.0	● orange	500	9037220000
H0.75/14T	0.75	18	14.0	8.0	1.7	0.15	0.3	5.5	3.0	11.0	● light blue	500	9037610000
H0.75/16T	0.75	18	16.0	10.0	1.7	0.15	0.3	5.5	3.0	13.0	● light blue	500	9037620000
H0.75/19TS	0.75	18	19.0	12.0	1.4	0.15	0.3	5.5	3.0	21.0	● light blue	500	9202840000
H0.75/24T	0.75	18	24.0	18.0	1.7	0.15	0.3	5.5	3.0	21.0	● light blue	500	9037630000
H1.0/15D	1.00	17	15.0	8.0	2.0	0.15	0.3	5.8	3.2	12.0	● red	500	9037440000
H1.0/19D	1.00	17	19.0	12.0	2.0	0.15	0.3	5.8	3.2	16.0	● red	500	9037450000
H1.0/25D	1.00	17	25.0	18.0	2.0	0.15	0.3	5.8	3.2	22.0	● red	500	9037460000
H1.5/16D	1.50	16	16.0	8.0	2.2	0.15	0.3	6.5	3.6	11.0	● black	500	9037470000
H1.5/20D	1.50	16	20.0	12.0	2.2	0.15	0.3	6.5	3.6	15.0	● black	500	9037480000
H1.5/26D	1.50	16	26.0	18.0	2.2	0.15	0.3	6.5	3.6	21.0	● black	100	9037490000
H2.5/19T	2.50	14	19.0	10.0	2.8	0.15	0.4	8.0	4.5	13.0	● grey	500	9037640000
H2.5/21T	2.50	14	21.0	12.0	2.8	0.15	0.4	8.0	4.5	15.0	● grey	100	9037650000
H2.5/27T	2.50	14	27.0	18.0	2.8	0.15	0.4	8.0	4.5	21.0	● grey	100	9037660000
H4.0/22T	4.00	12	22.0	12.0	3.5	0.2	0.5	9.0	5.2	15.0	● orange	100	9037670000
H4.0/28T	4.00	12	28.0	18.0	3.5	0.2	0.5	9.0	5.2	21.0	● orange	100	9037680000
H6.0/23T	6.00	10	23.0	12.0	4.5	0.2	0.5	11.4	6.2	20.0	● green	100	9037690000
H6.0/29T	6.00	10	29.0	18.0	4.5	0.2	0.5	11.4	6.2	24.0	● green	100	9037700000
H10.0/24T	10.00	7	24.0	12.0	5.8	0.2	0.5	13.4	7.6	17.0	● brown	100	9037710000
H10.0/30T	10.00	7	30.0	18.0	5.8	0.2	0.5	13.4	7.6	23.0	● brown	100	9037720000
H16.0/29T	16.00	6	29.0	16.0	8.3	0.3	0.6	17.2	9.5	20.0	○ white	50	9037730000
H16.0/38T	16.00	6	38.0	25.0	8.3	0.3	0.6	17.2	9.5	29.0	○ white	50	9037740000

other colour code

in multipack bag



Ordering data

Type	ø mm ²	AWG	L1	L2	D1	S1	S2	A	B	Stripping length	Colour	Qty.	Order No.
H0.75/16T	0.75	18	16.0	10.0	1.7	0.15	0.3	5.5	3.0	13.0	● light blue	500	9005140000
H1.0/15D	1.00	17	16.0	8.0	2.0	0.15	0.3	5.8	3.2	12.0	● red	500	9018540000
H1.0/19D	1.00	17	19.0	12.0	2.0	0.15	0.3	5.8	3.2	16.0	● red	500	9004760000
H1.5/16D	1.50	16	16.0	8.0	2.2	0.15	0.3	6.5	3.6	11.0	● black	500	9004420000
H1.5/20D	1.50	16	20.0	12.0	2.2	0.15	0.3	6.5	3.6	15.0	● black	500	9004750000
H2.5/19T	2.50	14	19.0	10.0	2.8	0.15	0.4	8.0	4.5	13.0	● grey	250	9018580000
H2.5/21	2.50	14	21.0	12.0	2.8	0.15	0.4	8.0	4.5	15.0	● grey	250	9005150000
H4.0/22T	4.00	12	22.0	12.0	3.5	0.2	0.5	9.0	5.2	15.0	● orange	100	9018590000
H6.0/23T	6.00	10	23.0	12.0	4.5	0.2	0.5	11.4	6.2	20.0	● green	100	9005160000
H10.0/26T	10.00	7	24.0	12.0	5.8	0.2	0.5	13.4	7.6	17.0	● brown	100	9005170000

Wire end ferrules for short-circuit and earth-fault-proof cables

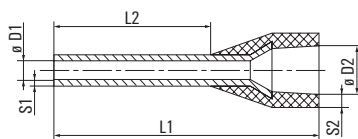

- Polypropylene conical cable entry
- Heat-resistant up to 105 °C
- Cable entry made from a non-flammable material on request

For conductors from 1.5 to 16 mm² (AWG 16-6)
Tin-plated copper
Dimensional tolerances to DIN 46228 part 4

Weidmüller colour code

packed loose



Ordering data

Type	Ø mm ²	AWG	L1	L2	D1	D2	S1	S2	Stripping length	Colour	Qty.	Order No.
H1.5/17.5 XS	1.50	16	17.5	8.0	1.8	6.8	0.15	0.3	20.0	● black	100	9202870000
H2.5/17.5 XS	2.50	14	17.5	8.0	2.3	7.6	0.15	0.3	20.0	● blue	100	9202880000

Weidmüller colour code

in multipack bag



Ordering data

Type	Ø mm ²	AWG	L1	L2	D1	D2	S1	S2	Stripping length	Colour	Qty.	Order No.
H1.5/17.5X	1.50	16	17.5	8.0	1.8	6.8	0.15	0.3	13.0	● black	100	9006590000
H1.5/19.5X	1.50	16	19.5	10.0	1.8	6.8	0.15	0.3	15.0	● black	100	9006630000
H2.5/17.5X	2.50	14	17.5	8.0	2.3	7.6	0.15	0.3	14.0	● blue	100	9006670000
H2.5/21.5X	2.50	14	21.5	12.0	2.3	7.6	0.15	0.3	17.0	● blue	100	9006710000
H4.0/19.5X	4.00	12	19.5	10.0	2.9	7.8	0.2	0.3	14.0	● grey	100	9006750000
H6.0/23.0X	6.00	10	23.0	12.0	3.6	8.1	0.2	0.3	17.0	● yellow	100	9006790000
H10.0/24.0X	10.00	7	24.0	12.0	4.6	9.6	0.2	0.3	17.0	● red	100	9006830000
H16.0/25.5X	16.00	6	25.5	12.0	6.0	11.9	0.2	0.3	26.0	● blue	100	9006870000

Wire end ferrules

Wire end ferrules with plastic collar, special sizes

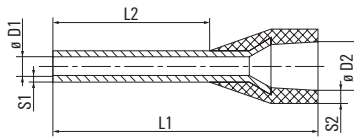

- Polypropylene conical cable entry
- Heat-resistant up to 105 °C
- Cable entry made from a non-flammable material on request

For conductors from 0.5 to 2.5 mm² (AWG 20-14)
Tin-plated copper
Dimensional tolerances to DIN 46228 part 4

Weidmüller colour code

packed loose



Ordering data

Type	σ mm ²	AWG	L1	L2	D1	D2	S1	S2	Stripping length	Colour	Qty.	Order No.
H0.34/11S	0.34	22	11.0	6.0	0.8	2.6	0.15	0.40	6.0	● turquoise	500	9204090000
H0.5/14S	0.50	20	14.0	8.0	1.0	2.9	0.15	0.25	10.0	● orange	500	9004560000
H0.5/14DS	0.50	20	14.0	8.0	1.0	2.9	0.15	0.25	10.0	○ white	500	9004590000
H0.5/16DS	0.50	20	16.0	10.0	1.0	2.9	0.15	0.25	12.0	○ white	500	9202910000
H0.5/16S	0.50	20	16.0	10.0	1.0	2.9	0.15	0.25	12.0	● orange	500	9202900000
H0.75/14S	0.75	18	14.0	8.0	1.2	3.4	0.15	0.25	10.0	○ white	500	9025960000
H0.75/14DS	0.75	18	14.0	8.0	1.2	3.4	0.15	0.25	10.0	○ white	500	9028580000
H0.75/14TS	0.75	18	14.0	8.0	1.2	3.4	0.15	0.25	10.0	● light blue	500	9018550000
H0.75/15S	0.75	18	15.0	9.0	1.2	2.8	0.15	0.25	10.0	○ white	500	9204240000
H1.0/14S	1.00	17	14.0	8.0	1.4	3.5	0.15	0.25	10.0	● yellow	500	9025970000
H1.0/14DS	1.00	17	14.0	8.0	1.4	3.5	0.15	0.25	10.0	● red	500	9018560000
H1.5/12S	1.50	16	12.0	6.0	1.7	3.5	0.15	0.25	8.0	● red	500	9025690000
H1.5/14S	1.50	16	14.0	8.0	1.7	3.9	0.15	0.25	10.0	● red	500	9025980000
H1.5/14DS	1.50	16	14.0	8.0	1.7	3.9	0.15	0.25	10.0	● black	500	9025240000
H2.5/12DS	2.50	14	12.0	6.0	2.2	4.2	0.15	0.25	8.0	● blue	500	9028490000
H2.5/12TS	2.50	14	12.0	6.0	2.2	4.2	0.15	0.25	8.0	● grey	500	9036200000
H2.5/14S	2.50	14	14.0	8.0	2.2	4.0	0.15	0.25	10.0	● blue	500	1333100000
H2.5/14TS	2.50	14	14.0	8.0	2.2	4.0	0.15	0.25	10.0	● grey	500	9426770000
H2.5/16DS	2.50	14	16.0	10.0	2.2	4.2	0.15	0.25	13.0	● blue	500	9036220000
H4.0/20D	4.00	12	20.0	12.0	2.8	4.7	0.20	0.50	15.0	● grey	500	9203630000
H10.0/22	10.00	7	22.0	12.0	4.5	7.1	0.20	0.60	15.0	● ivory	100	9203620000

Weidmüller colour code

in multipack bag



Ordering data

Type	σ mm ²	AWG	L1	L2	D1	D2	S1	S2	Stripping length	Colour	Qty.	Order No.
H0.75/14S	0.75	18	14.0	8.0	1.2	3.4	0.15	0.25	10.0	○ white	500	9025700000
H1.0/14S	1.00	17	14.0	8.0	1.4	3.5	0.15	0.25	10.0	● yellow	500	9025710000
H1.5/14DS	1.50	16	14.0	8.0	1.7	3.9	0.15	0.25	10.0	● black	500	9028360000
H1.5/14S	1.50	16	14.0	8.0	1.7	3.9	0.15	0.25	10.0	● red	500	9025720000

Wire end ferrules without plastic collar

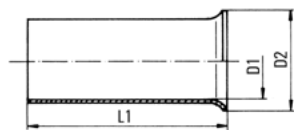

For conductors 0.25-185 mm² (AWG 24-350MCM)
Material: tin-plated copper
Dimensional tolerances to DIN 46228 part 1

without plastic collar

packed loose



Ordering data

Type	Ø mm ²	AWG	L1	L2	D1	D2	S1	S2	Stripping length	Colour	Qty.	Order No.
H0.25/5	0.25	24	5.0		0.8	1.6			5.0		1000	9018910000
H0.5/10	0.50	20	10.0		1.0	2.1			10.0		1000	9004050000
H0.5/6	0.50	20	6.0		1.0	2.1			6.0		1000	0282600000
H0.75/10	0.75	18	10.0		1.2	2.3			10.0		1000	0542500000
H0.75/6	0.75	18	6.0		1.2	2.3			6.0		1000	0282700000
H1.0/10	1.00	17	10.0		1.4	2.5			10.0		1000	0282800000
H1.0/6	1.00	17	6.0		1.4	2.5			6.0		1000	0372600000
H1.5/7	1.50	16	7.0		1.7	2.8			7.0		1000	0372700000
H1.5/10	1.50	16	10.0		1.7	2.8			10.0		1000	0186500000
H1.5/12	1.50	16	12.0		1.7	2.8			12.0		1000	9004060000
H1.5/18	1.50	16	18.0		1.7	2.8			18.0		1000	9004070000
H2.5/7	2.50	14	7.0		2.2	3.4			7.0		1000	0373000000
H2.5/10	2.50	14	10.0		2.2	3.4			10.0		1000	9004080000
H2.5/12	2.50	14	12.0		2.2	3.4			12.0		1000	0186100000
H2.5/18	2.50	14	18.0		2.2	3.4			18.0		1000	9004090000
H4.0/9	4.00	12	9.0		2.8	4.0			9.0		500	0373100000
H4.0/15	4.00	12	15.0		2.8	4.0			15.0		500	9004100000
H4.0/12	4.00	12	12.0		2.8	4.0			12.0		1000	0244100000
H4.0/18	4.00	12	18.0		2.8	4.0			18.0		500	9004110000
H6.0/10	6.00	10	10.0		3.5	4.7			10.0		500	9004120000
H6.0/12	6.00	10	12.0		3.5	4.7			12.0		500	0191900000
H6.0/15	6.00	10	15.0		3.5	4.7			15.0		500	0124700000
H6.0/18	6.00	10	18.0		3.5	4.7			18.0		500	9004130000
H10.0/12	10.00	7	12.0		4.5	5.8			12.0		500	0282900000
H10.0/15	10.00	7	15.0		4.5	5.8			15.0		500	0124800000
H10.0/18	10.00	7	18.0		4.5	5.8			18.0		500	0379300000
H16.0/12	16.00	6	12.0		5.8	7.5			12.0		500	0492500000
H16.0/15	16.00	6	15.0		5.8	7.5			15.0		500	0124300000
H16.0/18	16.00	6	18.0		5.8	7.5			18.0		100	0375200000
H16.0/25	16.00	6	25.0		5.8	7.5			25.0		100	9004150000
H16.0/32	16.00	6	32.0		5.8	7.5			32.0		100	9004160000
H25.0/15	25.00	3	15.0		7.3	9.5			15.0		250	0124400000
H25.0/18	25.00	3	18.0		7.3	9.5			18.0		100	0375300000
H25.0/25	25.00	3	25.0		7.3	9.5			25.0		250	9004170000
H25.0/32	25.00	3	32.0		7.3	9.5			32.0		100	9004180000
H35.0/18	35.00	2	18.0		8.3	11.0			18.0		100	0368900000
H35.0/25	35.00	2	25.0		8.3	11.0			25.0		100	9004190000
H35.0/30	35.00	2	30.0		8.3	11.0			30.0		100	9451000000
H35.0/32	35.00	2	32.0		8.3	11.0			32.0		100	9004200000
H50.0/18	50.00	1	18.0		10.3	13.0			18.0		100	9004210000
H50.0/22	50.00	1	22.0		10.3	13.0			25.0		100	9025880000
H50.0/32	50.00	1	32.0		10.3	13.0			32.0		100	9004220000
H70.0/25	70.00	2/0	25.0		12.5	15.0			25.0		50	9004230000
H70.0/32	70.00	2/0	32.0		12.5	15.0			32.0		50	9004240000
H95.0/25	95.00	3/0	25.0		14.5	17.0			25.0		50	9004250000
H95.0/32	95.00	3/0	32.0		14.5	17.0			32.0		50	9004260000
H120.0/32	120.00	4/0	32.0		17.2	19.0			32.0		25	9036240000
H150.0/32	150.00	300 MCM	32.0		19.5	21.0			32.0		25	9036250000
H185.0/32	185.00	350 MCM	32.0		21.2	23.5			32.0		25	9036260000

Insulated cable connectors

PVC, with conical cable entry



Ring cable connector



Ordering data

Type	Cross-section mm ²	Colour	Dimensions	d ¹	d	D	L	b	S1*	Qty.	Order No.
LIR 1.5M3 V	0.5 - 1.5	●	M 3	3.2	5.5	4.0	16.05	11.3	0.75	100	9200070000
LIR 1.5M3.5 V	0.5 - 1.5	●	M 3.5	3.7	5.5	4.0	16.05	11.3	0.75	100	9200080000
LIR 1.5M4 V	0.5 - 1.5	●	M 4	4.3	8.0	4.0	18.3	11.3	0.75	100	9200090000
LIR 1.5M5 V	0.5 - 1.5	●	M 5	5.3	8.0	4.0	18.3	11.3	0.75	100	9200100000
LIR 1.5M6 V	0.5 - 1.5	●	M 6	6.4	11.6	4.0	21.0	11.3	0.75	100	9200110000
LIR 1.5M8 V	0.5 - 1.5	●	M 8	8.4	11.6	4.0	21.0	11.3	0.75	100	9200120000
LIR 2.5M3 V	1.5 - 2.5	●	M 3	3.2	6.4	4.5	15.6	11.3	0.8	100	9200150000
LIR 2.5M3.5 V	1.5 - 2.5	●	M 3.5	3.7	6.4	4.5	15.6	11.3	0.8	100	9200160000
LIR 2.5M4 V	1.5 - 2.5	●	M 4	4.4	8.5	4.5	19.05	11.3	0.8	100	9200170000
LIR 2.5M5 V	1.5 - 2.5	●	M 5	5.3	8.5	4.5	19.05	11.3	0.8	100	9200180000
LIR 2.5M6 V	1.5 - 2.5	●	M 6	6.4	12.0	4.5	22.3	11.3	0.8	100	9200190000
LIR 2.5M8 V	1.5 - 2.5	●	M 8	8.4	12.0	4.5	22.3	11.3	0.8	100	9200200000
LIR 2.5M10 V	1.5 - 2.5	●	M 10	10.5	14.0	4.5	22.3	11.3	0.8	100	9200210000
LIR 6.0M4 V	4 - 6	●	M 4	4.3	9.5	6.4	22.4	14.15	1	100	9200230000
LIR 6M5 V	4 - 6	●	M 5	5.3	9.5	6.4	22.4	14.15	1	100	9200240000
LIR 6M6 V	4 - 6	●	M 6	6.4	12.0	6.4	24.65	14.15	1	100	9200250000
LIR 6M8 V	4 - 6	●	M 8	8.4	15.0	6.4	27.65	14.15	1	100	9200260000
LIR 6.0M10 V	4 - 6	●	M 10	10.5	15.0	6.4	27.65	14.15	1	100	9200270000

Fork-type cable connector

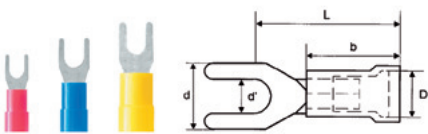

Ordering data

Type	Cross-section mm ²	Colour	Dimensions	d ¹	d	D	L	b	S1*	Qty.	Order No.
LIS 1.5M3 V	0.5 - 1.5	●	M 3	3.2	5.7	4.0	17.8	11.3	0.75	100	9200290000
LIS 1.5M3.5 V	0.5 - 1.5	●	M 3.5	3.7	6.4	4.0	17.8	11.3	0.75	100	9200300000
LIS 1.5M4 V	0.5 - 1.5	●	M 4	4.3	7.2	4.0	17.8	11.3	0.75	100	9200310000
LIS 1.5M5 V	0.5 - 1.5	●	M 5	5.3	8.1	4.0	17.8	11.3	0.75	100	9200320000
LIS 1.5M6 V	0.5 - 1.5	●	M 6	6.4	11.0	4.0	21.3	11.3	0.75	100	9200330000
LIS 2.5M3 V	1.5 - 2.5	●	M 3	3.2	5.7	4.5	17.8	11.3	0.8	100	9200350000
LIS 2.5M3.5 V	1.5 - 2.5	●	M 3.5	3.7	6.4	4.5	17.8	11.3	0.8	100	9200360000
LIS 2.5M4 V	1.5 - 2.5	●	M 4	4.3	7.2	4.5	17.8	11.3	0.8	100	9200370000
LIS 2.5M5 V	1.5 - 2.5	●	M 5	5.3	8.1	4.5	17.8	11.3	0.8	100	9200380000
LIS 2.5M6 V	1.5 - 2.5	●	M 6	6.4	11.0	4.5	21.3	11.3	0.8	100	9200390000
LIS 6.0M4 V	4 - 6	●	M 4	4.3	9.0	6.4	21.35	14.15	1	100	9200410000
LIS 6.0M5 V	4 - 6	●	M 5	5.3	9.0	6.4	21.35	14.15	1	100	9200420000
LIS 6.0M6 V	4 - 6	●	M 6	6.4	12.0	6.4	25.15	14.15	1	100	9200430000
LIS 6.0M8 V	4 - 6	●	M 8	8.4	14	6.5	34	13.15	1	100	9200440000
LIS 6.0M10 V	4 - 6	●	M 10	10.5	18	6.5	34.7	13.15	1	100	9200450000

S1* = Connection density

Pin-type cable connector

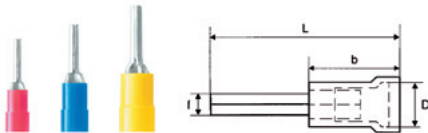

Ordering data

Type	Cross-section mm ²	Colour	Dimensions	D	L	b	f	Qty.	Order No.
LIP 1.5R12 V	0.5 - 1.5	●	12.0	4	23.3	11.3	1.9	100	9200460000
LIP 2.5R12 V	1.5 - 2.5	●	12.0	4.5	23.3	11.3	1.9	100	9200470000
LIP 6.0R14 V	4 - 6	●	14.0	6.4	28.15	14.5	2.7	100	9200480000

Hook-type cable connector

to ESI 50-18 part 2

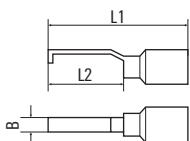

Ordering data

Type	Cross-section mm ²	Colour	L1	L2	B	Qty.	Order No.
HB 1-17	0.25 - 1.5	●	27.2	16.75	4.6	100	9036290000
HB 1-13	1.0 - 2.5	●	27.2	16.75	3.0	100	9036300000

PVC, with conical cable entry



Butt connector

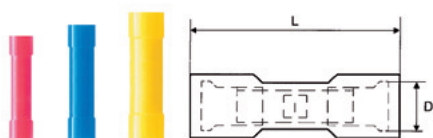

Ordering data

Type	Cross-section mm ²	Colour	Dimensions	D	L	Qty.	Order No.
LIB 1.5B25 VF	0.5 - 1.5	●	24.5	3.8	26	100	9200490000
LIB 2.5B25 VF	1.5 - 2.5	●	24.5	4.3	26	100	9200500000
LIB 6.0B26 VF	4 - 6	●	26.0	6	26	100	9200510000

Flat blade receptacles

with copper sleeve

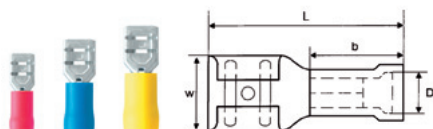

Ordering data

Type	Cross-section mm ²	Colour	Dimensions	d2*	d3*	D	L	b	w	Qty.	Order No.
LIF 1.5F288 R	0.5 - 1.5	●	2.8 x 0.8 mm	2.8	0.8	4.0	18.7	10.0	3.8	100	9200520000
LIF 1.5F488 R	0.5 - 1.5	●	4.8 x 0.8 mm	4.8	0.8	4.0	19.2	10.0	5.7	100	9200530000
LIF 1.5F638 R	0.5 - 1.5	●	6.3 x 0.8 mm	6.3	0.8	4.0	20.8	10.0	7.4	100	9200540000
LIF 2.5F488 R	1.5 - 2.5	●	4.8 x 0.8 mm	4.8	0.8	5.0	19.2	10.0	5.7	100	9200550000
LIF 2.5F638 R	1.5 - 2.5	●	6.3 x 0.8 mm	6.3	0.8	5.0	20.8	10.0	7.4	100	9200560000
LIF 6.0F638 R	4 - 6	●	6.3 x 0.8 mm	4.8	0.8	6.8	23.8	13.0	7.4	100	9200570000

Flat blade connector

with copper sleeve

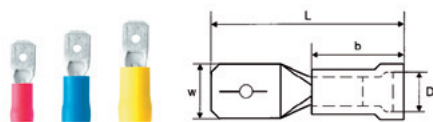

Ordering data

Type	Cross-section mm ²	Colour	Dimensions	d2*	d3*	D	L	b	w	Qty.	Order No.
LIF 1.5M638 R	0.5 - 1.5	●	6.3 x 0.8 mm	6.3	0.8	4.0	20.8	10.0	6.3	100	9200580000
LIF 2.5M638 R	1.5 - 2.5	●	6.3 x 0.8 mm	6.3	0.8	5.0	20.8	10.0	6.3	100	9200590000
LIF 6.0M638 R	4 - 6	●	6.3 x 0.8 mm	6.3	0.8	6.8	23.8	13.0	6.3	100	9200600000

Flat blade receptacles. piggy-back

with copper sleeve



Ordering data

Type	Cross-section mm ²	Colour	Dimensions	d2*	d3*	D	L	b	w	Qty.	Order No.
LIF 1.5T638 R	0.5 - 1.5	●	6.3 x 0.8 mm	6.3	0.8	4.0	20.8	10.0	7.4	100	9200610000
LIF 2.5T638 R	1.5 - 2.5	●	6.3 x 0.8 mm	6.3	0.8	5.8	20.8	10.0	7.4	100	9200620000
LIF 6.0T638 R	4 - 6	●	6.3 x 0.8 mm	6.3	0.8	6.8	23.8	13.0	7.4	100	9200630000

Flat blade receptacles. full insulation

with copper sleeve

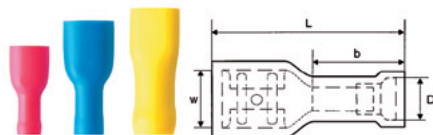

Ordering data

Type	Cross-section mm ²	Colour	Dimensions	d2*	d3*	D	L	b	w	Qty.	Order No.
LIF 1.5F638 RF	0.5 - 1.5	●	6.3 x 0.8 mm	6.3	0.8	4.0	22.0	10.5	7.4	100	9200640000
LIF 2.5F638 RF	1.5 - 2.5	●	6.3 x 0.8 mm	6.3	0.8	5.0	22.0	10.5	7.4	100	9200650000
LIF 6.0F638 RF	4 - 6	●	6.3 x 0.8 mm	6.3	0.8	6.8	24.5	13.0	5.7	100	9200660000

d2* = Plug-in width
d3* = Plug-in density

Insulated cable connectors

PVC, with conical cable entry



Round plug

with copper sleeve

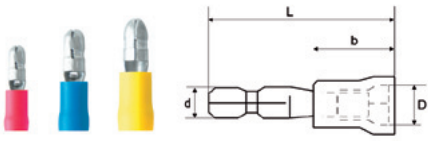

Ordering data

Type	Cross-section mm ²	Colour	Dimensions	d	D	L	b	Qty.	Order No.
LID 1.5M4 R	0.5 - 1.5	●	Ø 4 mm	4.0	4.0	20.8	10.0	100	9200670000
LID 2.5M5 R	1.5 - 2.5	●	Ø 5 mm	5.0	5.0	20.8	10.0	100	9200680000
LID 6.0M5 R	4 - 6	●	Ø 5 mm	5.0	5.8	23.8	13.0	100	9200690000

Sockets for round plugs

with copper sleeve

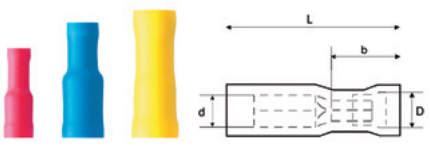

Ordering data

Type	Cross-section mm ²	Colour	Dimensions	d	D	L	b	Qty.	Order No.
LID 1.5F4 RF	0.5 - 1.5	●	Ø 4 mm	4.0	4.0	23.0	10.5	100	9200700000
LID 2.5F5 RF	1.5 - 2.5	●	Ø 5 mm	5.0	5.0	23.0	11.5	100	9200710000
LID 6.0F5 RF	4 - 6	●	Ø 5 mm	5.0	5.0	24.0	13.8	100	9200720000

Weidmüller Solutions & Service

Weidmüller Solutions & Service	Customer specific solutions: best advice, best solutions	V.2
	Digital support: RailDesigner®, Product Assistant for Distribution Boxes, Online product catalogue, M-Print® PRO label designer	V.8



Application specific solutions – Your requirements are our motivation

Each industry has its own requirements calling for more and more individual solutions aside from standard products. Your new product might have to contend with severe conditions. Many applications are subjected to high mechanical strains – through vibration or directly applied forces. Extreme temperature conditions or an application in hazardous areas are further factors your product must be able to comply with. We can offer you highly competent expertise to support you in the selection of ideal products, whatever your application. Feel free to contact us!

From custom product development, customer-specific assembly or application-specific products that are ready for use - we can help you to optimise your working processes and ensure your company's sustained efficiency, today, as well as for the future.

Individual product development

Working closely with you, we can develop individual and future-proof products using the latest technologies and which are specifically tailored to your application.

Customer-specific assembly

Our highly-skilled production expertise and broad product portfolio means that we can deliver superior solutions to meet and exceed your specification requirements.

Application-specific products

Our cross-industrial solutions set standards: Set up for your application, instantly ready for use and available from stock.



V

Individual product development for your success

We have a passion for simple, innovative solutions

Working with you, we can develop innovative and future-oriented products tailored to your application. Our philosophy is „one customer - one product“. It is not the product that is the starting point, but you, your technical specifications and your requirements.

A connecting partnership

The development of individual products means making the most of the experience and competencies available in the partnership. Our project management provides a professional and quality approach - from concept and design through to development, implementation and production. Our extensive knowledge of electrical connectivity, enclosure and sealing technology, as well as signal conditioning are all at your disposal.

Benefit from a reliable partner:

- **Increase the efficiency of your development and production processes**

Outsourcing the development and production of your components will shorten your time-to-market. In addition, you have more time to concentrate on your core competencies.

- **Take advantage of our applications and production experience and expertise**

You can draw on the accumulated knowledge of our applications engineers and our specialists in the fields of connection technology, enclosure and surface technology, as well as metal and plastic processing, which is second to none.

- **Feel safe with the professional approach of our project management**

Through innovation workshops, feasibility studies and profitability analyses we define a requirement profile forming the basis for the further development process. In this way, you can be sure of the best possible products for your needs.

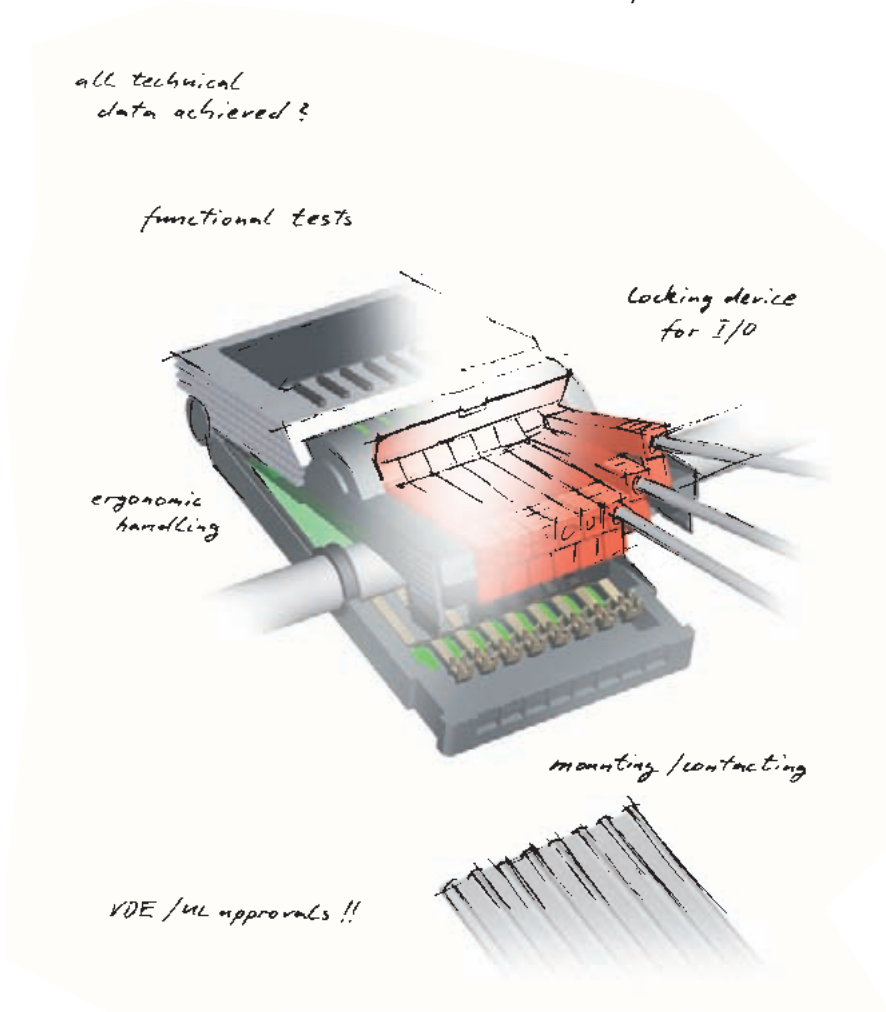

Application specific products – solutions for industries and markets

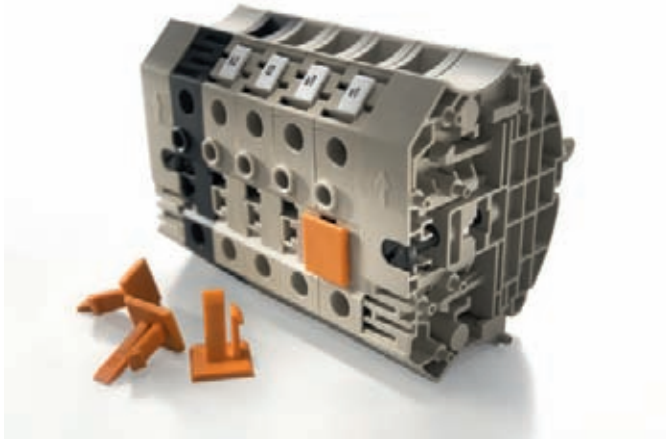

Industries and applications often have similar or even identical requirements for products or product assemblies. Application specific products that are based on earlier realised solutions are now directly available from stock.

Your advantage: You quickly get a suitable and cost-efficient solution.

Cross industrial solutions as standard

It is our aim to develop solutions that offer the additional advantage of a truly flexible design. Although this may mean an application-specific product may have an additional input or terminal you don't need, it can still be much cheaper than having a custom-made solution. Therefore, you not only save time, but money!



Reap multiple benefits:

- **High availability**

Application specific products are available from stock without delay. So you can rely on the delivery of your products when you need them.

- **Advice from application engineers**

Using the expertise of our applications engineers means that you can develop the solutions that are not only right, but which deliver added value to your applications.

- **Supportive software**

Project planning and evaluation is made easy with our software solutions such as NetCalc, RailDesigner® or Softclinic.

- **Worldwide application centres**

We stay in constant dialogue with our worldwide application centres, ensuring that our own application knowledge is shared, kept up to date and at your disposal anywhere you need us.



Customer specific assembly, tailored configuration



You may be looking to bring costs down and increase your efficiency. It may be that you would like more time to focus on your core competencies. You could be looking for a partner who will sent up intelligent solutions for you, that you can trust to deliver your specific requirements. Here at Weidmüller, we have a wealth of expertise, capability, and capacity to deliver custom solutions that are flexible, economically advantageous and on time.

We offer to work closely with you, providing support and advice, and in putting together the job specification. Furthermore, our broad product portfolio means that we can jointly work together on the selection of the best components to make up your custom solution.



Highest levels of professional production

You have complete access to our highly-skilled project management team and our production expertise, for example, in the ATEX area. We can offer you a comprehensive portfolio of customer-specific assemblies, from simple assembly to the modification of existing electronics products.

Our services include:

- Adaptation and assembly of enclosures for all IP protection classes
- ATEX solutions for hazardous areas
- Assembly of heavy duty connectors
- Assembly of terminal strips
- Customer specific electronics solutions
- Cable assembly

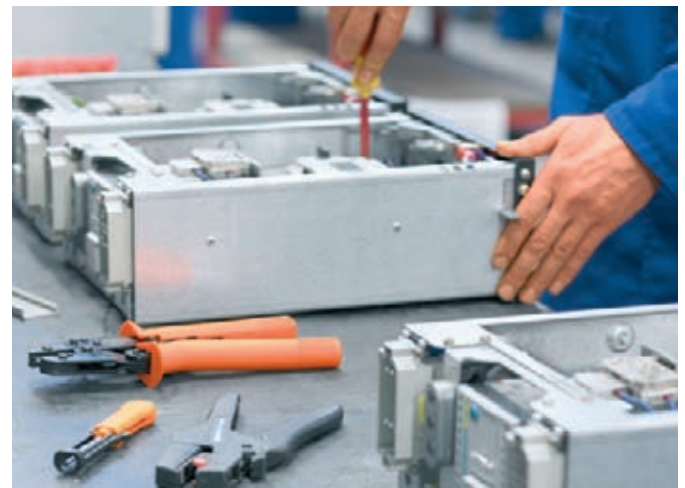

Take advantage of:

- **Simple ordering and stockholding information**

One solution – one item number! It will no longer be necessary to order single components. Article variety and stockholding will be reduced.

- **Professional assembly**

All individual components will be pre-assembled, reducing your own assembly time and costs.

- **Less costs for documentation**

Our RailDesigner® software will facilitate the generation of parts lists or drawings.

- **Modern processing of enclosures**

Our CNC processing centres can adapt the enclosures to suit your tailored solution.

Customer specific assembly – consultation, product, development and production – all from a single source

Our application and manufacturing expertise influences decisions on all areas of modern connection technology. They therefore play an integral part of every solution.

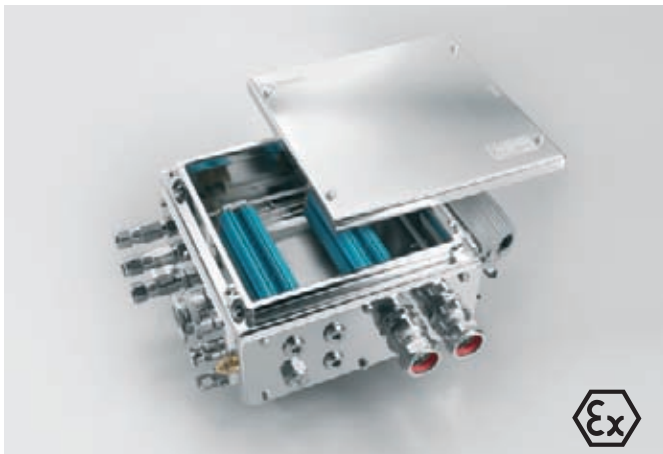

Enclosures

Perfect protection and safety

- Enclosures for all IP protection classes
- ATEX enclosures for hazardous areas
- Placement of inspection glasses, drill holes and threads
- Elaborate machining operations like the milling of contours
- Class C5 welding, according to DIN 6700, for stainless steel and sheet steel enclosures
- Surface coating as and when required
- Individual device and system markers



Heavy duty connectors

Perfect connection with system

- Placement of drill holes and cable glands
- Equipped with plug-and-play components
- Wiring of subassemblies
- Cable assembly
- All housings are available with individual laser marking



Terminal strips

Configuration made to measure

- Machining of mounting rails
- Snapping components onto terminal rails
- Placement of cross connections
- Mounting of standard conductors
- Marking of terminals, devices, conductors and cables



Electronics

Individual solution from the beginning

- Modular terminal blocks, component plugs, snap on bases, enclosures for electronics: integration of relevant electronic components
- Snap-on base: Component carrier design or simple wiring of the modules
- Interface units
- Modification of existing electronic products: Modification of the circuitry or specific calibration
- Combination of components: Relays or optocouplers in combination with other components



Cable assembly

Our special service

- Pre cutting of cables and conductors
- Installation of
 - Heavy duty connectors
 - PCB connectors or DIN connectors
- Conditioning of wire ends
- Mounting of wire end ferrules and cable lugs
- Connection of conductors to terminal rails

RailDesigner®

A faster way to configure and order terminal strips

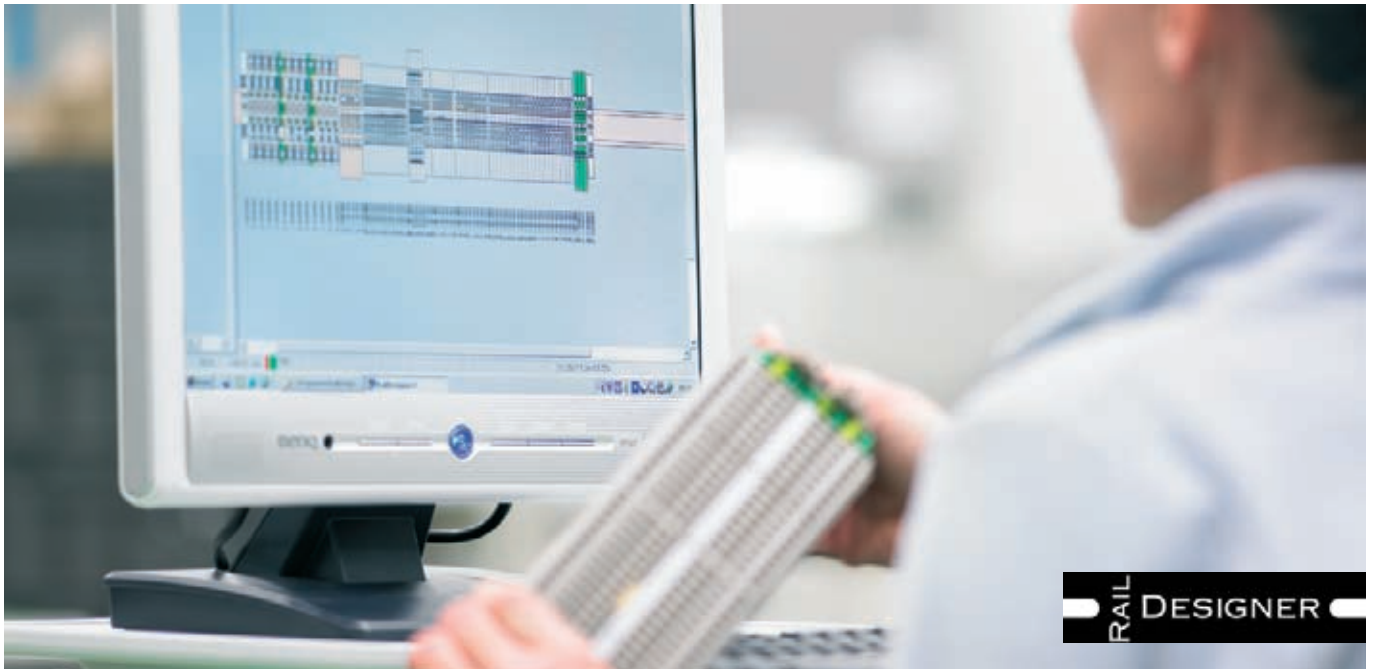

These days, time and cost efficiency are of the essence when it comes to working in planning and production. RailDesigner®, our free configuration and purchasing software, uses its virtual assembly of mounting rails (assembled or unassembled) to help you with the design of your own completely personal solution.

RailDesigner® brings you substantial benefits:

Less time required

It speeds up the process of acquiring quotations and placing orders because, for example, all processes can be initiated directly from the software. You configure your projects and the rest virtually takes care of itself!

User friendly operation

Any potential errors are prevented by automatic installation tips and clear project processing and management. So that you can plan your project realistically, RailDesigner® offers both 2D and 3D displays.

Wide selection from the current product portfolio

"You can easily download software updates for RailDesigner® from the internet. This means that you will always have access to the latest version of our product database."

Project planning that is compatible with your software

Plan and design your projects easily using your usual CAE software. With the integrated interface, transferring data from your CAE system has never been so simple. You can export component lists and terminal strip designs in various formats. Marking data is automatically transferred to the M-Print® Pro labelling software.

Simple purchasing of terminal strips

Once you have completed the planning stages of your projects in RailDesigner®, you can choose to send all of your data to us by email. Then we take over the assembly and deliver the required configuration to you, along with anything else that you still require for your project.

Download the software for free and discover the advantages to using RailDesigner® at www.raildesigner.de

Product assistant for distribution boxes and assemblies – The perfect solution, in the shortest time



You can easily and quickly select, combine and purchase the required components, all with the help of the Weidmüller product assistant for distribution boxes and assemblies. This means that you can rapidly obtain your individual enclosure solutions which may include the following components:

Empty enclosures without holes

Empty enclosures in various sizes of the Klippon® K and Klippon® POK series (aluminium and plastic) with matching mounting rails.

Empty enclosures with pre-threaded holes

Empty enclosures in different sizes from the Klippon® K and Klippon® POK series (aluminium and plastic), that are already equipped with metric threaded holes.

Mounting rails

Exactly tailored mounting rails for the enclosure sizes on offer.

Terminal strips

Mounting rails, which also perfectly match the offered enclosure sizes and are pre-fitted with terminals, optionally with screw or tension clamp connection.

Distribution boxes with Ex-protection

Enclosures that are already assembled with a terminal strip and already equipped with metric threaded holes.

Numerous possible combinations

Enclosures with Ex-protection are supplied exclusively with terminal strips that are already fitted. The product assistant offers you various approaches for industry variants so that you can create the right enclosure variant.

You can start off with any of the listed components and then add further components to the combination. This means that, for example, you can select the required terminal strip and the product assistant will then offer the matching enclosure variants.

Or, you can start with the enclosure, and matching terminal strips or mounting rails will then be chosen. The selected products can then be directly included in the query list.

Provision of all relevant data

During the selection, you can choose filters for the terminal strips, such as length, connection technology or dimensional cross-section and, for the enclosure, you can choose material, size, holes etc. If a product is then selected and combined, the user can view all of the relevant data, including drawings and pictures. This means that you can extensively plan how the enclosure will be integrated into the customer's application.

The product assistant is available at <http://galaxy.weidmueller.com>

Online product catalogue

If you have questions about the specifications and details of our products, perhaps even outside normal business hours, then our online catalogue at <http://catalog.weidmueller.com> is opened 24 hours a day, 365 days a year and is the perfect source for information. Besides product features and part numbers, it contains extensive additional information on all product groups.

For further information, offers and your personal contact, simply consult the Weidmüller website at

www.weidmueller.com

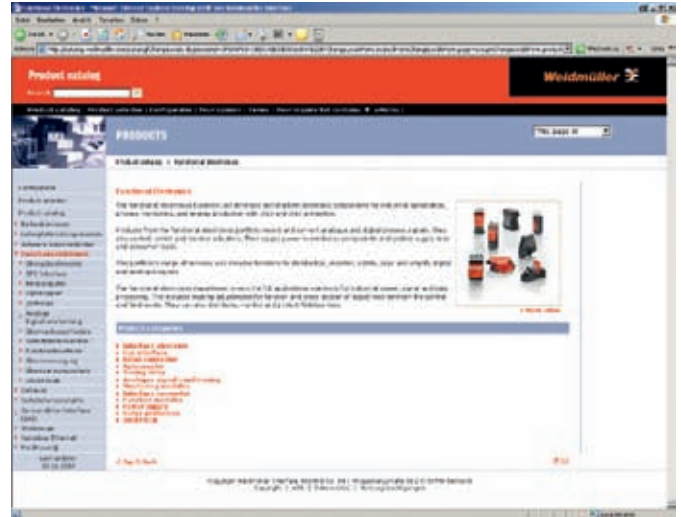

With one click selection for the product data sheet of your choice.

M-Print® PRO label designer

The comprehensive range of Weidmüller services includes the M-Print® PRO software. This is a professional standard, Windows®-based program for printing and ordering labels and markers that is coordinated with our current printing systems and marking materials.

M-Print® PRO enables you to design your labelling materials professionally and quickly. Texts, borders, lines, graphics, barcodes, serial numbers and photographs are all possible. The interface to RailDesigner® or your CAE system enables the transfer of all your configured data.

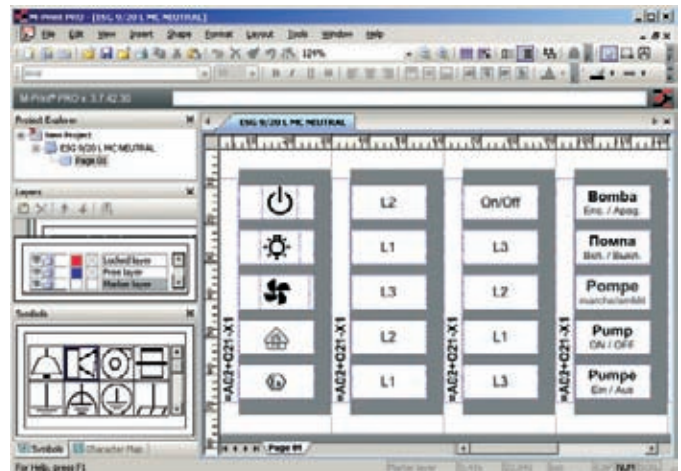

Technical appendix

Technical appendix	Connection systems	W.2
	Definitions of the various types	W.4
	Materials - Insulating materials	W.6
	Definition of overload and short-circuit protection	W.8
	Materials - Metals	W.10
	Norms, Standards, Terms	W.12
	General technical information	W.14
	Electrical data	W.16
	Installation instructions	W.20
	ATEX terminal blocks	W.26
	ATEX directives	W.28
	ATEX	W.29

Free choice of connection technology

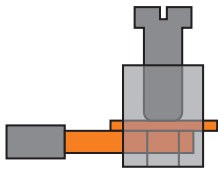

Clamping yoke connection technology

The **Weidmüller clamping yoke system** is an optimum combination of the specific properties of steel and copper. This clamping yoke system has proved its worth in billions of Weidmüller products over many decades. Both the clamping yoke and the clamping screw are made from hardened steel. This clamping yoke arrangement generates the necessary contact force. The clamping yoke presses the incoming conductor against a current bar made of copper or high-quality brass. The hardened Weidmüller clamping yoke ensures a gastight, vibration-resistant connection between conductor and current bar.

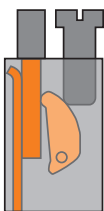

TOP connection technology

The Weidmüller **TOP connection system** ensures that the conductor can be inserted and the clamping screw tightened from the same direction. Such an arrangement eases the wiring work in certain installations, e.g. when there is little space at the sides in terminal boxes. The TOP connection system combines the specific properties of steel and copper. The hardened steel lever presses the conductor directly against a current bar made of copper or high-quality brass. The high contact force guarantees a gas-tight connection between conductor and current bar.

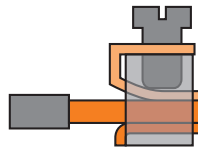

Leaf spring connection technology

Weidmüller's patented **leaf clamp connection system** is a screw connection system for large conductor cross-sections. The insertion of large conductors into the clamping point is made easier here by the fact that the clamping unit can be removed first. The conductor can then be placed directly on the current bar before re-inserting the clamping unit and tightening the screw to grip the conductor.

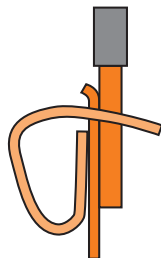

Tension clamp connection technology

The **Weidmüller tension clamp system** functions similarly to the tried-and-tested clamping yoke. Here again, the mechanical and electrical functions are kept separate. The spring, made from high-quality rustproof and acid-proof steel, pulls the conductor against the tin-plated copper current bar. Treating the copper in this way ensures low contact resistance and high corrosion resistance. The compensating effect of the spring ensures a secure contact for the lifetime of the terminal.

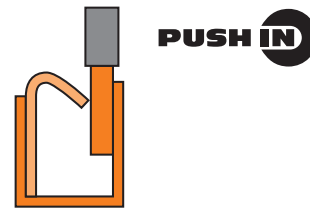

PUSH IN-connection technology

In our **PUSH IN connection technology** the stripped solid conductor is simply inserted into the clamping point as far as it will go. And that completes the connection! No tools are required and the result is a reliable, vibration-resistant and gas-tight connection. Even flexible conductors with crimped wire end ferrules or ultrasonic-welded conductors can be connected without any problems. A stainless steel spring, which is fitted in a separate housing, guarantees a high contact force between the conductor and the current bar (tin-plated copper). The conductor pull-out force for this system is even higher than that for the tension clamp system. A spring-stop plus conductor stop in a steel housing ensure optimum connection conditions and a guide for the screwdriver needed to detach the conductor.

The principle of vibration resistance

Clamping yoke

As the clamping screw is tightened, the ensuing force causes the upper threaded part to spring back and exert a locknut effect on the screw. The Weidmüller clamping yoke system is vibration-resistant. The relaxation of the conductor is compensated for by the elastic behaviour of the Weidmüller clamping yoke.

It is therefore not necessary to retighten the clamping screw.

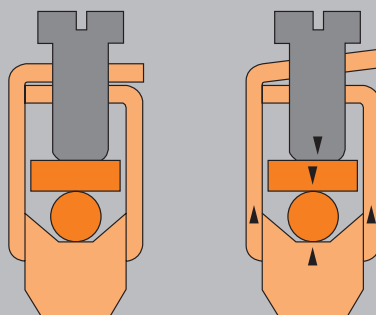

Leaf clamp

The distance "d" between the shaft of the clamping screw and the leaf clamp causes elastic deformation of the spring as the screw is tightened. The vibration resistance depends on the magnitude of the spring force of the leaf clamp, and this force also compensates the relaxation phenomena which occurs in the conductor. It is therefore not necessary to retighten the clamping screw.

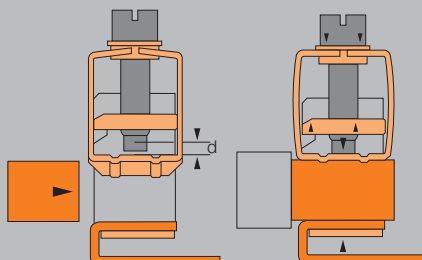

TOP

Like with the clamping yoke, the force exerted by the steel lever as the screw is tightened forces apart the two threaded parts of the TOP connection. This exerts a locking effect on the screw and guarantees excellent vibration resistance.

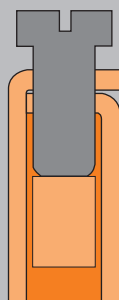

Definitions of the various types

PE terminals

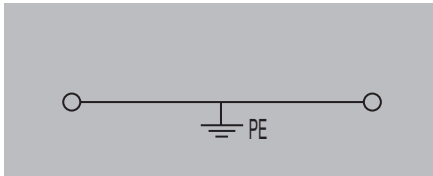

A PE terminal is a component with one or several clamping points for connecting and/or branching PE conductors (PE and PEN conductors) with a conductive connection to their mountings. Partly insulated PE terminals are insulated from adjacent live parts of terminals; the partial insulation is coloured green/yellow.

Applications (IEC 60947-7-2)

This standard applies to PE terminals with PE function up to 120 mm² and to PE terminals with PEN function for sizes upwards of 10 mm² with clamping points with or without screws for connecting round copper conductors with a cross-section between 0.2 and 120 mm² (AWG 24/250 kcmil) for circuits up to 1000 Vac/1000 Hz or up to 1500 Vdc. PE terminals are used to produce the electrical and mechanical connections between copper conductors and the mounting.

Fuse terminals

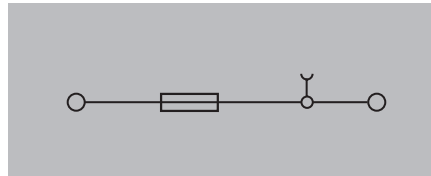

Fuse terminals consist of a terminal base and a cartridge fuse holder. In the case of fuse terminals for low-voltage cartridge fuses (D-system), the technical data is defined by IEC 60947-7-3 in conjunction with VDE 0636 part 301. In the case of fuse terminals for device protection cartridge fuses, the technical data is defined by IEC 60947-7-3, which covers the range of applications of such products.

Fuse terminals for protecting devices are rated for a certain maximum power loss on the basis of IEC 60127-2, which covers G-type cartridge fuses. The product pages contain details of the maximum power loss for individual or group arrangements for short-circuit and/or overload protection.

Multi-level distribution terminals

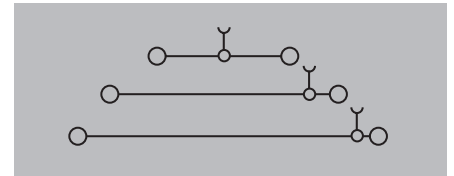

A multi-level distribution terminal is a unit with clamping points for connecting and/or linking phase, neutral and PE conductors to their mountings with a conductive PE connection. They have several connection levels, all isolated from each other.

Applications IEC 60947-7-1 / IEC 60947-7-2 DIN VDE 0611-4 (partly)

These standards apply to multi-level distribution terminals with clamping points with/without screws for connecting or linking solid, stranded or flexible copper conductors. In distribution terminals, phase conductor and/or N and PE conductor connections are all realised in a compact space. The N-conductor can be disconnected for insulation measurements; it is not used for disconnecting or switching.

PEN function

According to IEC 60947-7-2, only copper terminal rails may be used for the PEN function. Steel terminal rails may not be used.

Use of TS 35 x 15

In order to comply with the current-carrying ability required by IEC 60947-7-2, the TS 35 x 15 terminal rail must be used for PE terminals with a rated cross-section of 16 mm² and upwards.

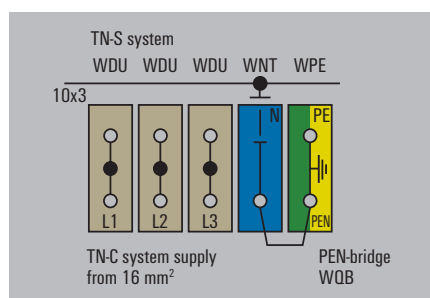

W

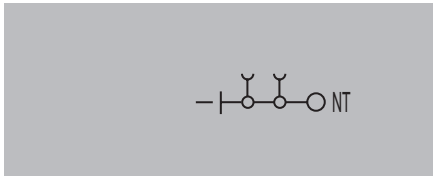
N-conductor disconnect terminals

A neutral-conductor disconnect terminal is a special type of test-disconnect terminal with lateral disconnection. It is connected to a neutral-conductor busbar. It is covered by the scope of the IEC 60947-7-1 (Appendix D). They enable simple testing without the need to disconnect the neutral conductor.

Dimensioning of clearance and creepage distances:

400 V applies to:
phase conductor–phase conductor

250 V applies to:
phase conductor–N-conductor
phase conductor–PE conductor
N-conductor–PE conductor

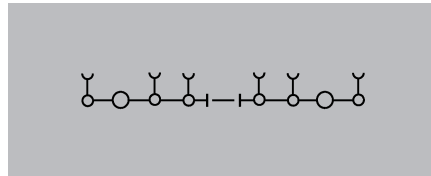
Test-disconnect terminals

Test-disconnect terminals are used for the short-term separation of circuits in order to perform test and measurements in a no-voltage state. They are covered by the scope of the IEC 60947-7-1 (Appendix D). The dimensions for the clearance and creepage distances of the opened disconnect points are not evaluated. However the rated surge voltage resistance (supplied by the manufacturer) must be verified at the opened disconnect point.

Insulating materials

In order to do justice to the most diverse requirements placed on our products, it is necessary to use different insulating materials tailored to the needs of the applications. None of the insulating materials used by Weidmüller contain any hazardous substances. Above all, the use of cadmium-free materials is very high on our agenda. Furthermore, our insulating materials contain neither pigments based on heavy metals nor any substances that lead to the formation of dioxin or furan.

	Ceramics	Thermosetting plastics	
Plastic Abbreviation	Ceramics	Gemin KrG	Epoxy resin EP
	<p>Ceramics are excellent materials for electrical engineering because they fulfil all requirements.</p> <p>Ceramics are resistant to heat, fluids and sparks, and are tested for leakage currents. Thanks to their high mechanical strength, low losses and good heat resistance, these materials have a very high chemical stability and are preferred because of their very low wear.</p>	<p>Thermosetting plastics exhibit high dimensional stability, low water absorption, extremely good tracking resistance and excellent fire resistance.</p> <p>The continuous operating temperatures are higher than those of thermoplastics. At higher thermal loads the deformation resistance of thermosetting plastics is better than that of thermoplastics.</p> <p>The disadvantage in comparison with thermoplastics is the reduced flexibility of thermosetting plastics.</p>	
	Insulating material	Melamine resin moulding compound, MF type 150 (DIN EN ISO 14 528) inorganic filler	Epoxy resin with inorganic filler
Colour	white	medium yellow	black
Description	<p>highest continuous operating temperature</p> <p>high fire resistance</p> <p>fluids-repellent</p> <p>high tracking resistance</p> <p>inherently flame-retardant</p>	<p>high continuous operating temperature</p> <p>high fire resistance</p> <p>high tracking resistance</p> <p>inherently flame-retardant</p> <p>halogen-free</p> <p>flame-retardant agent</p>	<p>very good electrical properties</p> <p>very high continuous operating temperature</p> <p>resistant to high-energy radiation</p> <p>halogen- and phosphor-free</p> <p>flame-retardant agent</p>
Properties			
Specific volume resistance to IEC 60093	Ω x cm	-	10 ¹¹
Electric strength to IEC 60243-1	kV / mm	>10	10
Tracking resistance (A) to IEC 60112	CTI	≥ 600	≥ 600
Upper max. permissible temperature	°C	250	130
Lower max. permissible temperature, static	°C	-60	-60
Flamability class to UL94		V-0 (5 V-B)	V-0 (5 V-A)
Fire behaviour to railway standard			

W

Thermoplastics				
Wemid	Polyamide PA	Polyamide PAGF	Polybutyleneterephthalate PBT	Polycarbonate PC
<p>Wemid is a modified thermoplastic with properties that have been specially devised to suit the requirements of Weidmüller connectors. The advantages in comparison with PA are better fire protection and the higher continuous operating temperature. Wemid fulfils the strict requirements placed on applications for railway rolling stock to NF F 16-101.</p>	<p>Polyamide (PA) is one of the most common commercial plastics. The advantages of this material are its very good electrical and mechanical properties, its flexibility and resistance to breakage. Furthermore, owing to its chemical structure PA achieves good fire resistance even without the use of flame-retardant agents.</p>	<p>Glass fibre-reinforced polyamide (PAGF) offers excellent dimensional stability and very good mechanical properties. This makes it ideal for use in end brackets. Compared with unreinforced PA, this material can achieve UL94 flammability class HB.</p>	<p>This thermoplastic polyester (PBT) offers excellent dimensional stability (and is therefore ideal for plug-in connectors) and a high continuous operation temperature. However, the tracking resistance is lower than other insulating materials.</p>	
special Weidmüller insulating material	insulating material	insulating material	with or without glass fibre reinforcement depending on application	with or without glass fibre reinforcement depending on application
dark beige	beige	beige	orange	grey
<p>higher continuous operating temperature improved fire resistance halogen- and phosphor-free flame-retardant agent flame-retardant agent low smoke development in fire certified for railway applications to NF F 16-101</p>	<p>flexible, virtually unbreakable good electrical and mechanical properties self-extinguishing behaviour halogen-free flame-retardant agent</p>	<p>excellent dimensional stability very good mechanical properties halogen-free flame-retardant agent</p>	<p>high dimensional stability good electrical and mechanical properties flame-retardant substances do not lead to the formation of dioxin or furan</p>	<p>high dimensional stability high continuous operating temperature high electrical insulation capacity halogen-free flame-retardant agent</p>
10 ¹²	10 ¹²	10 ¹²	10 ¹³	10 ¹⁶
25	30	30	28	≥ 30
600	600	500	200	≥ 175
120	100	100	115 / 130	115 / 125
-50	-50	-50	-50	-50
V-0	V-2	HB	V-0	V-2 / V-0
I2 / F2 *)				I2 / F2
*) also certified to LUL E 1042				

W

Power losses

This technical supplement should be used for determining the size of fuse inserts and fuse terminal blocks. It also shows the maximum permitted power losses for the fuse inserts in various applications and terminal block alignments.

1. Definition of overload and short-circuit protection

a) Short-circuit protection

Short circuits can occur when the insulation is broken or when there is continued stress on the insulating material. Almost all electrical consumers and lines should be protected against short circuits according to DIN VDE 0100-430/ HD 384.4.43 S1 and HD 384.4.473 S1.

The heat generated when a fuse insert is activated by a short circuit is low in comparison to an overload. This is because only a short pulse occurs with a short circuit. So in the case of a pure short circuit, the maximum permitted power loss of the fuse insert should be higher than the level for the overload protection.

b) Overload protection

With overload protection, cables and electrical components are protected against excessive load currents and the resulting thermal and mechanical damages.

Overload currents can occur with the following electrical components:

- Cables and busbars in power distribution networks
- Motors
- Transformers

When protecting against overloads, the heat energy released by the fuse inserts extends over a longer period of time. Thus the maximum power loss is less than with a pure short circuit.

2. Fuse terminal blocks arranged individually in accordance with IEC 60947-7-3

A single arrangement describes a terminal block consisting of five terminals, whereby four feed-through terminals are arranged around a fuse terminal block.

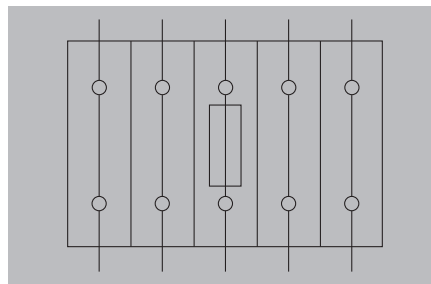

Figure 1: Fuse terminal blocks arranged individually

The maximum power loss of the fuse can, in comparison to a compound alignment, be rated higher because the individually aligned feed-through terminals dissipate little thermal energy.

3. Composite alignment of fuse terminal blocks in accordance with IEC 60947-7-3

A composite alignment describes a terminal block made from five fuse terminal blocks. The power loss for a short circuit or overload is determined based on the terminal in the middle.

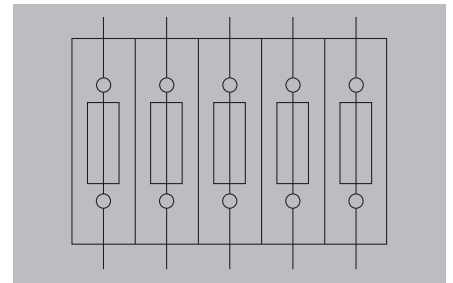

Figure 2: Fuse terminal blocks arranged as composites

The maximum power loss of the fuse should, in comparison to the individual alignment, be rated lower. The fuse terminal blocks arranged as a composite dissipate more thermal energy during operations.

4. Power losses for overload and short circuit protection in accordance with IEC 60947-7-3

The IEC 60127-x standard for cartridge fuse inserts describes three categories for power losses (1.6 W, 2.5 W, 4 W). The IEC 60947-7-3 standard for fused terminal blocks is also based on these groups. The values specified in these standards describe the power losses at 1.5 x IN.

Table 1: Example data for power loss specifications according to IEC 60947-7-3

Arrangement	Applications	
	Only short-circuit protection	Overload and short-circuit protection
Individual arrangement	4 W at max. 6.3 A	1.6 W at max. 6.3 A
Composite arrangement	2.5 W at max. 6.3 A	1.6 W at max. 6.3 A

Metals

Only materials that have proved suitable for electrical engineering applications are used in Weidmüller products. All materials are subjected to the rigorous quality control measures of a QM system certified to DIN EN ISO 9001. Environmental compatibility plays a crucial role in the selection of materials.

The selection, processing and surface treatment of all the metals used by Weidmüller are carried out according to the latest technical standards.

Steels

Steel parts required to maintain the contact force permanently are electrogalvanised and treated with an additional passivation technique. The surface protection conforms to the highest standards. Experience gained from laboratory tests has been incorporated into the design of the surface protection. Zinc protects against corrosion for a long time even after the zinc coating has been partially damaged by scratches or pores. In the presence of an electrolyte, zinc acts as a cathode (i.e. negative) with respect to steel. The metal ions of the zinc migrate to the steel, which provides long-term protection for the parent metal.

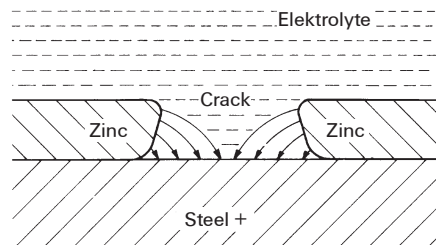

Conductive materials

The current-carrying materials copper, brass and bronze are characterised by their high conductivity and good mechanical properties.

The surfaces are usually given a coating of tin, which creates an extremely good, "malleable" contact with a low contact resistance. Apart from ensuring consistently good electrical properties, the tin coating provides excellent protection against corrosion.

Solder connections are also given a coating of tin. In order to guarantee the long-term solderability (shelf life), brass parts are given an additional nickel coating as a diffusion barrier.

The nickel coating provides effective protection against the loss of zinc atoms from the brass.

International Standards



Modular terminals to IEC 60947-7-1

Low-voltage switchgear and controlgear

Part 7-1:
Auxiliary devices – Terminals for copper conductors

This standard has been ratified by CENELEC on a European level and is as such valid in all CENELEC member countries.

In conjunction with this and having an overriding importance:
IEC 60947-1

Low-voltage switchgear and controlgear –General stipulations

(IEC 60947-7-1)
(EN 60947-7-1)

W This standard defines requirements for feed-through and disconnect-test terminals with screw or screwless terminal points which are primarily intended for industrial applications or similar and are attached to a carrier to produce an electrical and mechanical connection between copper cables.

The standard is valid for modular terminals for connecting round copper conductors with a cross-section between 0.2 mm² and 300 mm² (AWG 24/600 kcmil), for electric circuits up to 1000 V AC/1000 Hz or up to 1500 V DC.

This standard can be used as a guide for:

- Terminals that require the attachment of special fixtures to the conductor such as tab or wire-wrap connectors, etc.
- Terminals that directly contact the conductor through cutting or which create contact points by penetrating the insulation, for example as in insulation eg. such as in insulation displacement connections, etc.

Feed-through terminal

An insulating part consisting of one or more terminal groups that are isolated from each other, and is designed to be mounted to a carrier.

Rated cross-section

The rated cross-section of a modular terminal is the size – as specified by the manufacturer – of the conductor cross-section that can be connected to the terminal, on which certain thermal, mechanical and electrical requirements are based, and which is intrinsic to the marking on the terminal.

The rated cross-section is selected from the following standard cross-sections: 0.2 - 0.5 - 0.75 - 1.0 - 1.5 - 2.5 - 4.0 - 6.0 - 10 - 16 - 25 - 35 - 50 - 70 - 95 - 120 - 150 - 240 - 300 mm².

The modular terminals possess a rated connection capacity that is at least two steps smaller than the rated cross-section. The conductors may be solid, multi-strand or fine-strand components, if necessary with the ends of the conductors prepared for the connection.

Verification of the rated cross-section is carried out with a gauge, according to IEC 60947-1.

Rated current IEC 60947-7-1

Test currents are assigned to the rated cross-sections in accordance with IEC 60947-7-1. No non-permissible rise in the temperature of the terminal occurs in conjunction with these rated currents:

mm ²	1.5	2.5	4.0	6.0
A	17.5	24	32	41

mm ²	10	16	25	35
A	57	76	101	125

mm ²	50	70	95	120
A	150	192	232	269

mm ²	150	185	240	300
A	309	353	415	520

Conventional free-air thermal current (I_{th})

The conventional thermal current in free air (I_{th}) is the largest test current for warming tests of open equipment in the free air, see 4.3.2.1 of IEC 60947-1.

This applies exclusively to terminal blocks with multiple connection levels (**multi-tier terminals**) and to **test-disconnect terminals** for which a current reduction is permissible. The reduced current values are then designated as **conventional thermal current in free air (I_{th})**.

If the test current is not required to be reduced for the associated rated cross-section, then the term remains "rated current".

Rated voltage IEC 60947-7-1

The rated voltage of a modular terminal is the rated insulation voltage on which the insulation tests and creepage distances are based. They are determined according to IEC 60664-1.

Rated impulse withstand voltage IEC 60947-7-1

This is the value of a surge voltage to which the modular terminals can be subjected and on which the clearances to IEC 60947-1 or IEC 60664-1 are based.

Pollution severity IEC 60947-7-1

The pollution severity specifies the influence of solid, liquid or gaseous foreign matter that could reduce the electric strength of the specific surface resistance.

Pollution severity 3 has been specified for modular terminals for industrial applications: the occurrence of conductive contamination or dry, non-conductive contamination which becomes conductive because condensation is expected.

The minimum clearance is defined in IEC 60947-7-1 in conjunction with the rated impulse withstand voltage.

Operating conditions

The modular terminals can be used in the following standard conditions:

- Ambient temperature -5 °C...+40 °C, average value over 24 h: +35 °C
- Attitudes up to 2000 m above sea level
- Relative humidity 50 % at +40 °C, 90 % at +20 °C

CE marking

The manufacturer is responsible for CE labelling in accordance with the corresponding EU Directive. This confirms conformance with the Directive for the attention of government authorities. It is designed to guarantee the free movement of goods within Europe. Cable connectors from ≥ 50 V~/75 V- fulfil the fundamental safety requirements stipulated in the Low Voltage Directive 2006/95/EC. This is printed on the packaging. Together with the appropriate technical documentation declarations of conformity are kept available for review by the responsible monitoring authority.

(EMC)

Interference immunity

Terminals used in applications that fall under the scope of the IEC/EN 60947-7-1 are immune to electromagnetic disturbances. For that reason no immunity tests are required.

Emitted interference

Terminals used in applications that fall under the scope of the IEC/EN 60947-7-1 do not generate electromagnetic disturbances. For that reason no emitted interference tests are required.

IP class of protection to DIN EN 60529

The ingress protection class or IP rating is indicated by a code consisting of the two letters IP and two digits representing the class of protection.

Example: **IP 65**
 | |
 2nd digit: protection from liquids
 1st digit: protection from solid bodies

Protection against intrusion of external particle matter (1st digit)

Code digit		
0		No protection
1		Protection against ingress of large solid bodies with diameter > 50 mm. (Protection to prevent dangerous parts being touched with the back of the hand.)
2		Protection against ingress of large solid bodies with diameter > 12.5 mm. (Protection to prevent dangerous parts being touched with the fingers.)
3		Protection against ingress of large solid bodies with diameter > 2.5 mm. (Protection to prevent dangerous parts being touched with a tool.)
4		Protection against ingress of large solid bodies with diameter > 1 mm. (Protection to prevent dangerous parts being touched with a piece of wire.)
5		Protection against harmful deposits of dust, which cannot enter in an amount sufficient to interfere with satisfactory operation.
6		Complete protection against ingress of dust.

Protection against penetration of liquids (2nd digit)

Code digit		
0		No protection
1		Protection against drops of condensed water falling vertically.
2		Protection against drops of liquid falling at an angle of 15° with respect to the vertical.
3		Protection against drops of liquid falling at an angle of 60° with respect to the vertical.
4		Protection against liquids splashed from any direction.
5		Protection against water jets projected by a nozzle from any direction.
6		Protection against water from heavy sea on ships' decks.
7		Protection against immersion in water under defined conditions of pressure and time.
8		Protection against indefinite immersion in water under defined conditions of pressure (which must be agreed between manufacturer and user and must be more adverse than number 7).

Conversion table for AWG to mm² conductors

AWG

AWG is the abbreviation for „**A**merican **W**ire **G**auge“. This designation bears no resemblance to the actual cross-section of the conductor.

The relationship between AWG and mm² is shown in the following table.

Plug gauge to IEC 60947-1

Insertion of unprepared round conductors with the largest prescribed cross-section

Test with defined gauge, insertion simply under self-weight

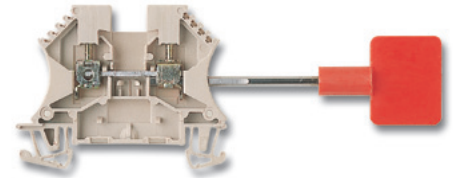

AWG	mm ²
28	0.08
26	0.13
24	0.20
22	0.33
20	0.52
19	0.65
18	0.82
17	1.04
16	1.31
15	1.65
14	2.08
13	2.63
12	3.31
11	4.17
10	5.26
9	6.63
8	8.37
7	10.55
6	13.30
5	16.77
4	21.15
3	26.67
2	33.63
1	42.41
0	53.48

Conductor cross-section		Plug gauge					
Flexible conductor mm ²	Rigid conductor (solid or stranded) mm ²	Form A			Form B		Permissible deviation for a and b mm
		Designation	Diameter a mm	Width b mm	Designation	Diameter a mm	
1.5	1.5	A 1	2.4	1.5	B 1	1.9	0 - 0.05
2.5	2.5	A 2	2.8	2.0	B 2	2.4	
2.5	4	A 3	2.8	2.4	B 3	2.7	
4	6	A 4	3.6	3.1	B 4	3.5	0 - 0.06
6	10	A 5	4.3	4.0	B 5	4.4	
10	16	A 6	5.4	5.1	B 6	5.3	
16	25	A 7	7.1	6.3	B 7	6.9	0 - 0.07
25	35	A 8	8.3	7.8	B 8	8.2	
35	50	A 9	10.2	9.2	B 9	10.0	
50	70	A 10	12.3	11.0	B 10	12.0	0 - 0.08
70	95	A 11	14.2	13.1	B 11	14.0	
95	120	A 12	16.2	15.1	B 12	16.0	
120	150	A 13	18.2	17.0	B 13	18.0	

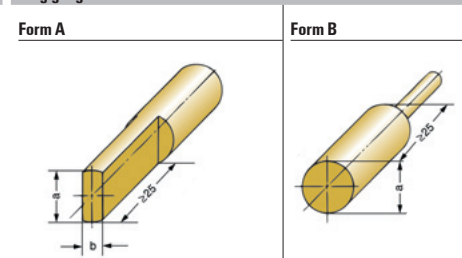

Design of the clearances and creepage distances in electrical equipment – general



Since April 1997 the sizing of clearances and creepage distances has been covered by IEC 60664-1 "Insulation coordination for electrical equipment in low-voltage systems".

The design data resulting from these provisions is – if applicable – specified in this catalogue for each product.

For the design of clearances and creepage distances, application of the regulations for insulation coordination produces the following interrelationships:

Clearances

Clearances are rated in accordance with the following factors:

- Anticipated overvoltage **rated impulse withstand voltage**
- Used **overvoltage protection precaution**
- Measures to prevent pollution **pollution severity**

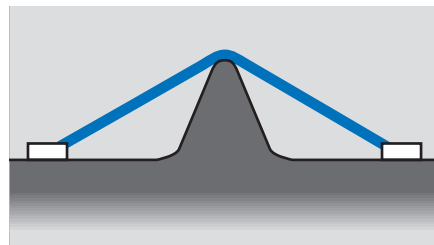

Creepage distances

Creepage distances are rated in accordance with the following factors:

- Planned **rated voltage**
- Insulation materials used **insulation group**
- Measures to prevent pollution **pollution severity**

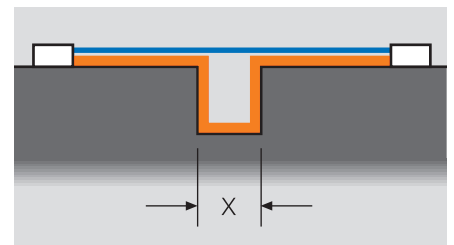
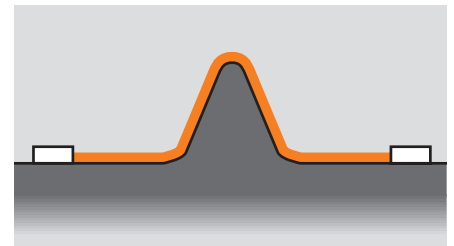

Slots are taken into account when measuring creepage distances if their minimum width x is dimensioned according to the following table:

Pollution severity	min. width X [mm]
1	0.25
2	1
3	1.5
4	2.5

If the associated clearance in air is less than 3 mm, the minimum slot width can be reduced to 1/3 of the clearance.

Design of clearances and creepage distances in electrical equipment – influencing factors

Rated impulse withstand voltage

The rated impulse withstand voltage is derived from:

- **Voltage conductor – earth**
(the rated voltage of the network, taking into account all networks)
- **Surge category**

Table 1: Rated impulse withstand voltages for electrical equipment

Rated voltage of power supplies system *) in V		Rated impulse withstand voltage in kV			
Three-phase systems	Single-phase systems with neutral point	Electrical equipment at the supplies point of the installation (Surge category IV)	Electrical equipment as part of the permanent installation (Surge category III)	Electrical equipment to be connected to the permanent installation (Surge category II)	Specially protected electrical equipment (Surge category I)
	120 to 240	4.00	2.50	1.50	0.80
230/400					
277/480		6.00	4.00	2.50	1.50
400/690		8.00	6.00	4.00	2.50
1000		Values depend on the particular project of, if no values are available, the values of the preceding line apply.			

*) to IEC 38

Surge categories

are stipulated in accordance with the German standard DIN VDE 0110-1 (for electrical equipment fed directly from the low-voltage network).

Surge category I

- Equipment that is intended to be connected to the permanent electrical installation of a building. Measures to limit transient surges to the specific level are taken outside the equipment, either in the permanent installation or between the permanent installation and the equipment.

Surge category II

- Equipment to be connected to the permanent electrical installation of a building, e.g. household appliances, portable tools, etc.

Surge category III

- Equipment that is part of the permanent electrical installation and other equipment where a higher degree of availability is expected, e.g. distribution boards, circuit-breakers, wiring systems (including cables, busbars, junction boxes, switches, power sockets) in the permanent installation, and equipment for industrial use and some other equipment, e.g. stationary motors with permanent connections to the permanent installation.

Surge category VI

- Equipment for use at or near the power supplies in the electrical installations of buildings, between the principal distribution and the mains, e.g. electricity meters, circuit-breakers and centralised ripple controllers.

Pollution severity categories

Pollution severity category 1

- No pollution, or only dry, non-conductive pollution that has no influence.

Pollution severity category 2

- Non-conductive pollution only; occasional condensation may cause temporary conductivity.

Pollution severity category 3

- Conductive pollution, or dry, non-conductive pollution that is liable to be rendered conductive through condensation.

Pollution severity category 4

- Contamination results in constant conductivity, e.g. caused by conductive dust, rain or snow.

Unless explicitly stated otherwise, the dimensioning of clearance and creepage distances and the resulting rating data for electromechanical products (terminals, terminal strips, PCB connection terminals and plug-in connectors) is based on pollution severity 3 and surge category III, taking account of all network types.

Design of clearances and creepage distances in electrical equipment – influencing factors

Rated voltage

The rated voltage is derived from the nominal voltage of the power supply and the corresponding network type.

Single-phase 2- or 3-wire AC or DC systems		
Rated voltage of the power supply (mains)*	Voltages for table 4	
	For insulation phase-to-phase ¹⁾ All systems	For insulation phase-to-earth ¹⁾ 3-wire systems neutral pt. earthing
V	V	V
12.5	12.5	-
24 / 25	25	-
30	32	-
42 / 48 / 50**)	50	-
60	63	-
30-60	63	32
100**)	100	-
110 / 120	125	-
150**)	160	-
220	250	-
110-220	250	125
120-240		
300**)	320	-
220-440	500	250
600**)	630	-
480-960	1000	500
1000**)	1000	-

3-phase 3- or 4-wire AC systems			
Rated voltage of the power supply (mains)*	Voltages for table 4		
	For insulation phase-to-phase All systems	For insulation phase-to-earth	
V	V	3-phase 4-wire systems with earthed neutral wire ²⁾	3-phase 3-wire systems unearthed ¹⁾ or phase-earthed
60	63	32	63
110/120/127	125	80	125
150**)	160	-	160
208	200	125	200
220/230/240	250	160	250
300**)	320	-	320
380/400/415	400	250	400
440	500	250	500
480/500	500	320	500
575	630	400	630
600**)	630	-	630
660/690	630	400	630
720/830	800	500	800
960	1000	630	1000
1000**)	1000	-	1000

- 1) Phase-to-earth insulation levels for unearthed or impedance-earthed systems are equal to those of phase-to-phase because the operating voltage to earth of any phase can, in practice, reach full phase-to-phase voltage. This is because the actual voltage to earth is determined by the insulation resistance and capacitive reactance of each phase to earth; thus, a low (but acceptable) insulation resistance of one phase can earth it and raise the other two to full phase-to-phase voltage to earth.
 - 2) For electrical equipment for use in both 3-phase 4-wire and 3-phase 3-wire supplies, earthed and unearthed, use the values for 3-wire systems only.
- *) It is assumed that the rated voltage of the electrical equipment is not lower than the nominal voltage of the power supply.
- **) Because of the common changes, the meaning of the ** symbol has not been used in table 1; i.e. the / symbol indicates a 4-wire 3-phase distribution system. The lower value is the phase-to-neutral voltage, while the higher value is the phase-to-phase voltage. Where only one value is indicated, it refers to 3-wire 3-phase systems and specifies the value phase-to-phase. The values given in table 1 are still taken into account in tables 3a and 3b by the ** symbol.

Insulating material group

The insulating materials are divided into four groups depending on the comparative figures for creepage distance (CTI = comparative tracking index):

Insulating material group	
I	600 ≤ CTI
II	400 ≤ CTI < 600
III a	175 ≤ CTI < 400
III b	100 ≤ CTI < 175

The comparative tracking index must be determined using special samples produced for this purpose with test solution A in compliance with IEC 60112 (DIN IEC 60112/DIN VDE 0303-1).

The installation of terminal strips

Assembly and end brackets

- Assemble terminal strips from left to right.
- Closed side on the left, open on the right.
- Always close off the open side of a modular terminal with an end plate or partition plate (WAP/TW, ZAP/TW and IAP).
- Fit end brackets to both ends of a terminal strip.
- End brackets can be omitted adjacent to PE terminals, with the exception of WDK/PE and ZPE + WPE 1.5 / R 3.5.

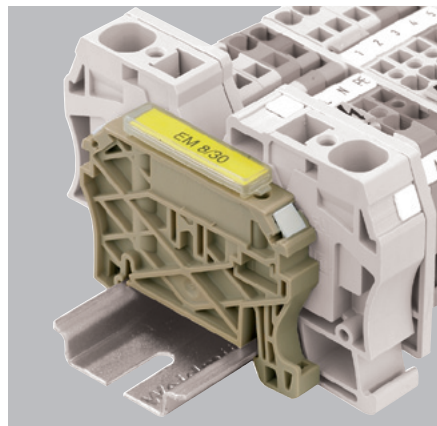
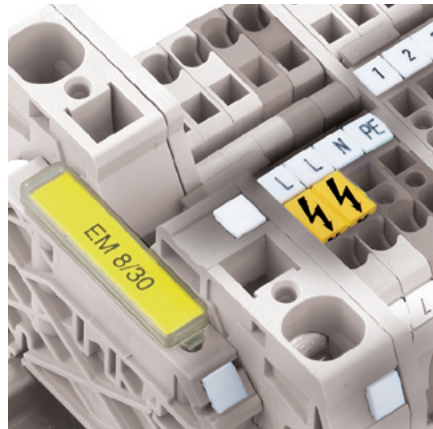

Dimensions

The dimensions specified are those of the enclosing housing to the modular terminal, including fixing components but excluding tolerances. A mounting tolerance of 0.2 mm on the specified terminal width should be allowed for in the planning.

Partition plate

A partition plate is required to create a visual distinction between electric circuits, or to ensure electrical isolation between neighbouring cross-connections.

Combinations of various terminals

- Always fit an end plate or partition plate (WAP/TW, ZAP/TW and IAP) at changes of profile.
- Always fit end plates or partition plates (WAP/TW, ZAP/TW and IAP) between adjacent terminals with different rated voltages in order to maintain the respective voltages.
- When a PE terminal is required adjacent to or between associated feed-through terminals of the same series and size, the rated voltage and rated impulse withstand voltage of the feed-through terminals are not affected.

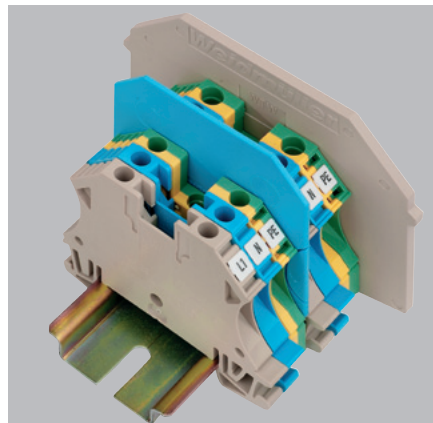

Separation plate

Separation plates can be retrofitted between cross-connections or sockets on modular terminals up to a terminal width of max. 12 mm.

Maintaining the rated insulation voltage

The required stripping length is specified in mm for every Weidmüller product. These lengths, e.g. 6 ± 0.5 mm, $\geq 10 \pm 1$ mm, must be maintained. This also applies when using wire end ferrules. The outside dimensions of crimped wire end ferrules must comply with IEC 60947-1, 1999 edition.



Working on electrical connections with non-insulated screwdrivers



The use of non-insulated screwdrivers is only permitted on electrical systems that have been isolated. To ensure that the electrical components have been disconnected from the power supply, the following five safety rules must be adhered to before carrying out any

work and guaranteed for the duration of the work:

- **Isolation**
- **Prevention of reconnection**
- **Verification of disconnection**
- **Earthing and short-circuiting**
- **Covering or guarding of adjacent parts still connected to the power supply**

These five safety rules represent the safety measures to be taken when working on electrical systems and equipment. The individual measures to be carried out taking into account the operational and local conditions, e.g. exposed high- or low voltage lines, cables or switchgear, are specified in VDE 0105 part 100.

Unused clamping points connected to the power supply

Suitable covers, e.g. ADP 1...4, must be fitted to prevent electrical shock caused through accidental contact with unused clamping points that could conduct electricity. The clamping screws of all unused clamping points, even those isolated from the electricity supply, must be screwed fully home.

**VDE 0105 part 100
Operation of power supplies:
work on such systems**

Perform troubleshooting operations with a 2-pole voltage tester including test prod to IEC 61243-3.



Tightening torques for clamping screws

Tightening the clamping screw with the appropriate torque guarantees:

- A secure and gas-tight connection
- No mechanical damage to the clamping parts
- A voltage drop well below the permissible limit

The test torque to IEC 60947-1 or the torque as specified by the manufacturer is the lower value of the permissible torque range. This ensures that all tests are satisfied.

The upper value of the permissible torque range is the maximum torque that may be applied by the user.

An electric screwdriver should preferably be set to a torque in the middle of the range. The values given in the table are general figures. Torques specific to the products have been specified directly for each product.

Products with screw with slotted head		
Thread	Tightening torque	
	Steel screws	A 2/A 4-80
	min. 8.8	[Nm]
M 2	0.2...0.35	0.2...0.35
M 2.5	0.4...0.8	0.4...0.8
M 3	0.5...1.0	0.5...1.0
M 3.5	0.8...1.6	0.8...1.6
M 4	1.2...2.4	...
M 5	2.0...4.0	...
M 6	2.5...5.0	...

Products with screw with hexagon socket		
Thread	Tightening torque	
	Non-ferrous screws	Cu 5 (CuNi 60)
	Cu 2 (CuZn)	[Nm]
M 2.5	0.4...0.45	...
M 3	0.5...0.6	0.5...1.0
M 3.5	...	0.8...1.6
M 4	1.2...1.9	1.2...2.4
M 5	2.0...3.0	2.0...4.0
M 6	...	2.5...5.0

Products with screw with hexagon socket	
Thread	Tightening torque
	Steel screws
	[Nm]
M 4	1.2...2.4
M 5	2.0...4.0
M 6	3.0...6.0
M 8	6.0...12
M 10	10.0...20
M 12	14.0...31
M 16	25.0...60

Connecting the terminals

Two conductors at one clamping point

The optimum solution for allocation of individual circuits, labelling and the breakdown into separate functional units is best achieved by connecting just one conductor at every clamping point.

However, if it is necessary to connect two conductors with the same cross-section at one clamping point, then this is possible with the modular terminals of the W-Series (screw connection).

The connection of two cables in screwless clamping units is forbidden according to DIN IEC 60999-1.

The Z-series (tension-clamping) can be used to connect two conductors if twin wire-end ferrules are used.

- **Continuous current rating with two conductors**

The total current of two conductors may not exceed the continuous current rating of the modular terminal. The continuous current rating is the maximum current that a modular terminal can accommodate without the temperature rise exceeding 45 K.

- **Rated voltage**

The Rated voltage of the modular terminal does not change when two conductors are connected properly.

File E60693	Torque NM	Voltage	Current	WI Catalog No.
Multi wire test for:				
sec 38	0,8	600	25	WDU 2.5
sec 38	1	600	35	WDU 4
sec 38	1.6	600	50	WDU 6
sec 38	2.4	600	65	WDU 10
sec 38	4	600	85	WDU 16
sec 38	5	1000	125	WDU 35
sec 38	0.8			WPE 2.5
sec 38	1			WPE 4
sec 38	1.6			WPE 6
sec 38	2.4			WPE 10
sec 38	4			WPE 16
sec 38	5			WPE 35
sec 38	0.8	300	20	WDK 2.5...
sec 38	0.8	300	20	WDK 2.5/DU-PE
sec 38	0.5	300	20	WDU 1.5/ZZ
sec 38	0.5			WPE 1.5/ZZ
sec 38	0.8	300	20/10	WDU 2.5/1.5/ZR
sec 38	0.5			2.5
sec 38	0.8			WPE 2.5/1.5/ZR
sec 38	0.5			1.5
sec 38	0.8	300	10	WPO 4
sec 38	0.5	300	10	WDU 1.5/BLZ 5.08
sec 38	0.8	300	10	WDK 2.5/BLZ 5.08
sec 38	0.8	300	16	WDU 2.5 F
sec 38	0.8	300	16	WDK 2.5 F
sec 47	0.5	300	10	BLZ 5.08/2
sec 38				WDU 50N
sec 38				WPE 50N
sec 75				WDU 70N
sec 75				WPE 70N
sec 38				WDK 2.5/TR DU/σTNHE
sec 38				WDK 2.5/TR DU-PE/σTNHE
sec 38				WTR 2.5
				WDU 50N
				WPE 50N
				WDU 70N
				WPE 70N
				WDK 2.5/TR DU/σTNHE
				WDK 2.5/TR DU-PE/σTNHE
				WTR 2.5
				WDK 4N
				WDK 4N PE
				WDK 4N V
				WDU 4/ZR
				WDU 4/ZZ
				WPE 4/ZR
				WPE 4/ZZ
				WTR 4/ZR
				WTR 4/ZR STB 2.3
				WTR 4/ZZ
				WTR /ZZ STB 2.3
				WTL 4/2 STB
				WTL 4
				WTR 4
				WTR 4 STB
				KDKS 1/EN4
				KDKS 1 PE/35
				MAK 2.5 DB

¹⁾ Passed with lowered current rating

²⁾ Passed with differing number of wires

³⁾ Still in work

The maximum number of identical cross-sections

UL Rated Terminal Blocks																			
Wire cross-section AWG (mm ²)																			
#30 (0.05)	#28 (0.08)	#26 (0.13)	#24 (0.21)	#22 (0.33)	#20 (0.5)	#18 (0.75)	#16 (1.5)	#14 (2.5)	#12 (4)	#10 (6)	#8 (10)	#6 (16)	#4 (25)	#2 (35)	#1 (40)	1/0 (50)	2/0 (70)	3/0 (80)	
Number of the same Size Wires per Terminal																			
4	4	4	4	4	4	3	3	2	1	-	-	-	-	-	-	-	-	-	-
-	-	-	-	4	4 (29 A) ¹⁾	3	3	2	1	1	-	-	-	-	-	-	-	-	-
-	-	-	-	4	4 (30 A) ¹⁾	3	3	3	2	1	1	-	-	-	-	-	-	-	-
-	-	-	-	4	4	4	4 (46 A) ¹⁾	3 (50 A) ¹⁾	2 (50 A) ¹⁾	1	1	1	1	-	-	-	-	-	-
-	-	-	-	-	-	-	4 (67 A) ¹⁾	4 (62 A) ¹⁾	3 (71 A) ¹⁾	2 (67 A) ¹⁾	1	1	1	-	-	-	-	-	-
-	-	-	-	-	-	-	-	3	3	3 (90 A) ¹⁾	2	2 (114 A) ¹⁾	1	1	1	-	-	-	-
4	4	4	4	4	4	3	3	2	1	-	-	-	-	-	-	-	-	-	-
-	-	-	-	4	4	3	3	2	1	1	-	-	-	-	-	-	-	-	-
-	-	-	-	4	4	3	3	3	2	1	1	-	-	-	-	-	-	-	-
-	-	-	-	4	4	4	4	3	2	1	1	1	-	-	-	-	-	-	-
-	-	-	-	-	-	-	4	4	3	2	1	1	1	-	-	-	-	-	-
-	-	-	-	-	-	-	-	3	3	3	2	2	1	1	1	-	-	-	-
4	4	4	4	4	4	3	2	2	1	-	-	-	-	-	-	-	-	-	-
4	4	4	4	4	4	3	2	2	1	-	-	-	-	-	-	-	-	-	-
-	-	4	4	4	3	1	1	1	-	-	-	-	-	-	-	-	-	-	-
-	-	4	4	4	3	1	1	1	-	-	-	-	-	-	-	-	-	-	-
4	4	4	4	4	4	3	3	2	1	-	-	-	-	-	-	-	-	-	-
-	-	4	4	4	3	1	1	1	-	-	-	-	-	-	-	-	-	-	-
-	-	4	4	4	4	2 ²⁾	3	2	2	1	-	-	-	-	-	-	-	-	-
-	-	4	4	4	3	1	1	1	-	-	-	-	-	-	-	-	-	-	-
4	4	4	4	4	4	3	2	2	1	-	-	-	-	-	-	-	-	-	-
4	4	4	4	4	4	3	3	2	1	-	-	-	-	-	-	-	-	-	-
4	4	4	4	4	4	3	2	2	1	-	-	-	-	-	-	-	-	-	-
4	4	4	4	4	4	2	1	1	-	-	-	-	-	-	-	-	-	-	-
											2	2	1	1	1	1			
											2	2	1	1	1	1			
								5	5	5	2	2	2	1	1	1	1		
								5	5	5	2	2	2	1	1	1	1		
				4	4	3	2	1	1										
				4	4	3	2	1	1										
4	4	4 ³⁾	4 ³⁾	3 ³⁾	3 ³⁾	3 ³⁾	3 ³⁾	2 ³⁾	1										
											2	2	1	1	1	1			
											2	2	1	1	1	1			
								5	5	5	2	2	2	1	1	1	1		
								5	5	5	2	2	2	1	1	1	1		
				4	4	3	2	1	1										
				4	4	3	2	1	1										
4	4	4	4	3	3	3	3	2	1										
covered by WDK 4N																			
covered by WDK 4N																			
				4 ²⁾	4 ²⁾	3 ²⁾	3 ²⁾	2 ²⁾	1 ²⁾	1 ²⁾									
covered by WTR 4/ZZ																			
covered by WTR 4/ZZ																			
covered by WTR 4/ZZ																			
covered by WTR 4/ZZ																			
covered by WTR 4/ZZ																			
				4 ²⁾	4 ²⁾	3 ²⁾	3 ²⁾	2 ²⁾	1 ²⁾	1 ²⁾									
covered by WTR 4/ZZ																			
				4 ²⁾	4 ²⁾	3 ²⁾	3 ²⁾	2 ²⁾	1 ²⁾	1 ²⁾									
				4 ²⁾	4 ²⁾	3 ²⁾	3 ²⁾	2 ²⁾	1 ²⁾	1 ²⁾									
covered by WTR 4/ZZ STB 2.3																			
covered by KDKS 1/PE/35																			
4 ²⁾	4 ²⁾	4 ²⁾	4 ²⁾	4 ²⁾	4 ²⁾	3 ²⁾	3 ²⁾	2 ²⁾	1 ²⁾	1 ²⁾									
4 ²⁾	4 ²⁾	4 ²⁾	4 ²⁾	4 ²⁾	4 ²⁾	3 ²⁾	3 ²⁾	2 ²⁾	1 ²⁾	1 ²⁾									

Connecting the terminals

Cross-connections systems

Weidmüller can supply the cross-connections WQV and ZQV – fully insulated against electric shock – with various numbers of poles (2- to 20-pole). Please note that the rated voltage is reduced when using cross-connections.

Protection against electric shock is not provided at the ends of shortened cross-connections.

Such cross-connections must be used with partition plates or end plates in order to maintain the rated voltage.

Leaf clamp conductor connection for large cross-sections

It is no longer the case that conductors with large cross-sections have to be forced into the clamping point. Instead, they can now be easily placed in the modular terminal.

In addition to the individual form, every type of terminal can also be supplied in the form of 3-, 4- and 5-pole blocks. All the blocks are permanently screwed together and therefore guarantee additional rigidity.

Direct mounting is possible thanks to the elongated holes on the underside of the terminals. Terminal blocks can be screwed directly to mounting plates with a 25 mm pitch.

The other advantages are:

- Constant force transfer through self adjusting connection system
- Mounting in any direction
- Electric shock protection (finger-proof) to German standard VBG 4, also with cross-connections
- Extremely resistant to distortion

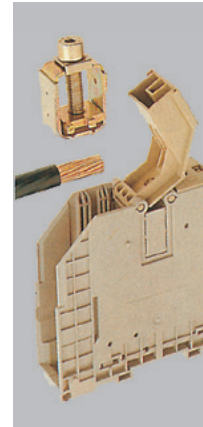

Open cover and remove screw assembly.



Insert conductor and replace screw assembly.



Close cover and tighten screw with Allen key.

The use of aluminium conductors

Weidmüller terminal blocks are suitable for the direct connection of **single strand round** and **sector-shaped aluminium wires**.

In contrast to copper, aluminium exhibits certain characteristics that must be taken into account when using this material as a conductor in electrical engineering.

A thin, non-conductive layer of oxide forms immediately on the unprotected surface of the aluminium as soon as it is exposed to the air.

This layer increases the contact resistance between the aluminium conductor and the current bar of the modular terminal. And that, in unfavourable conditions, can lead to poor contact.

1. Scrape the stripped end of the conductor carefully, eg. with a knife, to remove the layer of oxide.
Caution: Do not use brushes, files or emery paper because particles of aluminium can be deposited on other conductors.
2. After removing the layer of oxide, coat the end of the conductor immediately with a neutral grease, e.g. acid- and alkalifree Vaseline, and connect it to the terminal immediately.
3. Repeat the above procedure if at any time the conductor is disconnected and reconnected.
4. The above installation instructions are valid for solid round or sector aluminium conductors only.

Solid round and sector conductors				
Terminal type	Rated cross-section	Reduced rated current when connecting an aluminium conductor	Clamping screw thread size	Tightening torque
W-Series	mm²	„A“		Nm
WDU 2.5	2.5	20	M 2.5	0.4
WDU 4	4	27	M 3	0.5
WDU 6	6	35	M 3.5	0.8
WDU 10	10	48	M 4	1.2
WDU 16	16	50	M 5	3.0
WDU 35	35	60	M 6	4.0
WDU 120	150	290	M 10	15.0
WDU 240	240	415	M 10	25.0-30.0
SAK-Series				
SAK 2.5	2.5	20	M 2.5	0.5-0.8
SAK 4	4	27	M 3	0.6-1.0
SAK 6	6	35	M 3.5	1.2-1.6
SAK 10	10	48	M 4	2.0-2.4
SAK 16	16	64	M 4	2.0-2.4
SAK 35	35	105	M 6	4.0-6.0

Stranded conductors				
W-Series				
WFF 35	35	105	M 6	3.0-6.0
WFF 70	70	163	M 8	6.0-12.0
WFF 120	120	230	M 10	10.0-20.0
WFF 185	185	300	M 12	15.5-31.0
WFF 300	300	409	M 16	30.0-60.0

Installation advice when using flat cable lugs

When tightening the terminal it is advisable to hold the conductor to prevent deformation of the terminal rail and to avoid twisting the foot of the terminal. When connecting **stranded aluminium conductors** to modular terminals, it is advisable to use an aluminium cable lug chosen to match the type of conductor and connected according to the instructions of the cable lug manufacturer.

It is necessary to fit a copper-plated aluminium washer between the aluminium cable lug and the copper current bar of the modular terminal. This is the only way of guaranteeing a reliable transition between the copper and the aluminium. Fit the washer in such a way that the copper side is in contact with the current bar, and the aluminium side in contact with the cable lug.

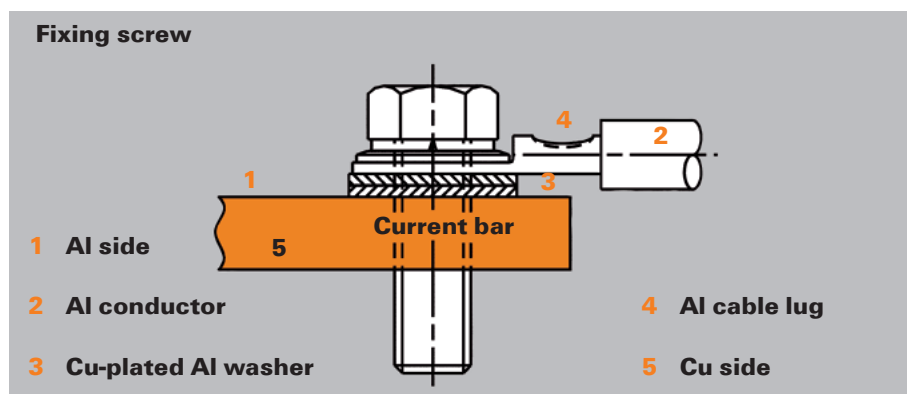

ATEX terminals blocks

Modular terminals for explosive conditions – complying with the European ATEX Directive 94/9/EC

Principles

IEC 60947-7-1 (EN 60 947-7-1/VDE 06 11pt. 1) and IEC 60 947-7-2 (EN 60 947-7-2/ VDE 06 11pt.3) specify the basic provisions for modular terminals or PE terminals. In addition, when used in hazardous areas the standard EN 60079-0 applies; where increased safety 'e' is required EN 60079-7 applies. According to EN 60079-0 modular terminals for explosive conditions are so-called explosion-proof components. Components are those parts and assemblies that are necessary for the safe operation of devices and protective systems without themselves fulfilling an autonomous function.

Components are not marked with the CE mark in accordance with the European ATEX directive 94/9/EG. EX terminal blocks are certified for the increased safety "e" ignition protection category.

The certifying body approved under the Directive RL 94/9/EC issue EC Type Approval Certificates in accordance with EN 60079-0/60079-7 and the ATEX Directive 94/9/EC. By issuing the 'Production Quality Assurance Notification' the approved certifying authority KEMA confirms that the manufacturer has fulfilled the requirements contained in the ATEX Directive in accordance with the Appendices IV and VII. Copies of the EC Type Approval Certificates, the notifying committee and the Declarations of Conformity are available via the Internet.

The clamping yoke, tension clamp, insulation displacement and the PUSH IN terminal block system offer increased protection against accidental loosening and have been designed in such a manner that the ends of flexible wire conductors need no preparation.

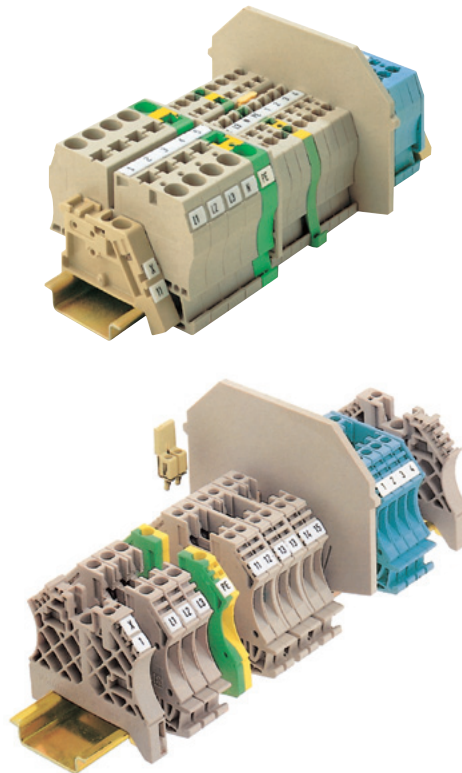

Marking

RL94/9EG: ⓧ II 2 G-D

- ⓧ Equipment for explosive conditions
- II 2-G Equipment group II category 2 (Zone 1 equipment)
- II 2-D Equipment group II category 2 (Zone 21 equipment)

EN 60079-7: Ex e II

- Ex Explosion protection
- e Increased safety
- II Equipment group

KEMA 97ATEX4677U (example)

- KEMA Notified body
- ATEX Conformity with 94/9/EG
- U Component

Certified for the European Directive 94/9/EG – ATEX –

Electrical data

The values for current-carrying capacity as stated in the catalogue are based on an ambient temperature of 40°C. When loaded with the rated current + 10%, the temperature of the current bar of the modular terminal may not rise more than 40 K.

Taking into account a further safety factor according to EN 60079-0, we reach the following definitions:

Temperature class	Ambient temperature
T6	-50 °C to +40 °C
T5 to T1	-50 °C to +55 °C

The permitted nominal current must be reduced accordingly if the actual ambient temperature is higher.

The continuous operating temperature to EN 60079-0 for the material KRG is 130 °C, for Wemid it is 120 °C and for the material PA it is 80 °C.

Accessories

The accessories listed can be used and included in the ATEX certification. Where necessary, end plates or partitions must be installed as described to ensure adherence to creepage and clearance distances for Ex e applications.

Design for Ex i

Terminals for intrinsically-safe circuits ("i") are passive components. Therefore, for use in intrinsically-safe circuits, you do not need an EC-standard examination certificate.

The blue terminals are recommended for clear labelling and easy recognition. The construction type of these terminals must comply with EN 60079-11.

Additional information about using Weidmüller terminals in intrinsically-safe circuits can be requested from the manufacturer.

Accessories

The accessories listed can be used and comply with EN 60079-11.

Current-carrying capacity of cables and lines

Cross-sect.	VDE 0298 part 4 (IEC364-5-523) Current-carrying capacity of lines		EN 60079-7
	Ambient temperature 30 °C Factor 1.0 Installation type C + 3 current-carrying wires PVC 70 °C A	Umgebungstemp. 40 °C, Faktor 0.87 Verlegeart C + 3 bel. Adern PVC 70 °C A	Type of ignition "increased safety" Connection terminals Ambient temperature 40 °C, 40 K temperature rise Current equivalent to the conductor connected A
1.5	17.5	15.225	15
2.5	24	20.88	21
4	32	27.84	28
6	41	35.67	36
10	57	49.59	50
16	76	66.12	66
25	101	87.87	88
35	125	108.75	109
50	150	130.5	131
70	192	167.04	167
95	232	201.84	202
120	269	234.03	234
150	309	268.83	267
185	353	307.11	307
240	415	361.05	361
300	520	452.4	452

The current-carrying capacity of cables and lines in the installation is defined by VDE 0298 part 4 as normal at an ambient temperature of 30 °C. At 40 °C the operating current must be reduced by a factor of 0.87.

Installation

The general statements regarding standard applications are also valid for Ex i applications. In particular, the Ex i requirements always apply to the entire circuit, i.e. also to parts in areas not at risk of explosion.

Clamping of two conductors in Ex e applications

For the terminals from our W-series, it is normally permitted to connect two wires per clamping position as long as this is permitted in accordance with the type test according to IEC 60947-7-1 or 60947-7-2. It is important to be sure that two of the same cross-sections are used below the rated cross-section.

ATEX directives

Since July 1, 2003, all new facilities in explosion risk zones must be certified according to ATEX Directive 94/9/EG or ATEX 95 (ATEX: ATmosphère EXplosive = explosive atmosphere). This directive is one of the “New-Approach” directives. It is valid in all European Union countries, as well as Iceland, Lichtenstein and Norway. In these countries, the directive refers to the sale and commissioning of products which have been designed particularly for high explosion risk environments (where explosive atmospheres exist due to gases, vapours, mists, or dusts). It now also covers the mining sector and purely mechanical devices.

Class of protection

Type of protection	Code	CENELEC EN	IEC	Product category explosion protect.
General requirements	-	60079-0	60079-0	-
Oil immersion	o	60079-6	60079-6	2
Pressurised apparatus	p	60079-2	60079-2	2
Powder filling	q	60079-5	60079-5	2
Flameproof enclosure	d	60079-1	60079-1	2
Increased safety	e	60079-7	60079-7	2
Intrinsic safety	ia	60079-11	60079-11	1
Intrinsic safety	ib	60079-11	60079-11	2
Intrinsic safety	ic	60079-11	60079-11	3
Type n (Ex n)	n	60079-15	60079-15	3
Encapsulation	m	60079-18	60079-18	2

Classification for potentially explosive areas

CENELEC classification IEC60079-10	Presence of potentially explosive atmosphere	Product category	US classification NEC 500	Combustible media
Zone 0	permanent, long-term	1G	Class I, Div 1	Gases, Vapours
Zone 20	or frequently	1D	Class II, Div 1	Dust
Zone 1	occasionally	2G	Class I, Div 1	Gases, Vapours
Zone 20		2D	Class II, Div 1	Dust
Zone 2	rarely and	3G	Class I, Div 2	Gases, Vapours
Zone 22	briefly	3D	Class II, Div 2	Dust

Explosion groups

Gas (e.g.)	CENELEC	NEC 500
Propane	IIA	D
Ethylene	IIB	C
Hydrogen	IIC	B
Acetylene	IIC	A
Methane (mining)	I	mining (MSHA)

Temperature classes

Max. surface temperatur (°C)	Temperature class CENELEC	Temperature class NEC 500-3
450	T1	T1
300	T2	T2
280	-	T2A
260	-	T2B
230	-	T2C
215	-	T2D
200	T3	T3
180	-	T3A
165	-	T3B
160	-	T3C
135	T4	T4
120	-	T4A
100	T5	T5
85	T6	T6

ATEX codes

Example of marking – modular terminal WDK 2.5 N

- 1 • Rated voltage
- 2 • European symbol for explosion protection.
- 3 • Certificate number
- 4 • Rated conductor cross-section
- 5 • CENELEC explosion protection type “e” – Group II (gases, vapours, mists)
 - Device category 2 – Application in Zone 1 or 2
 - Approval for applications in gases (“G”) or dusts (“D”).

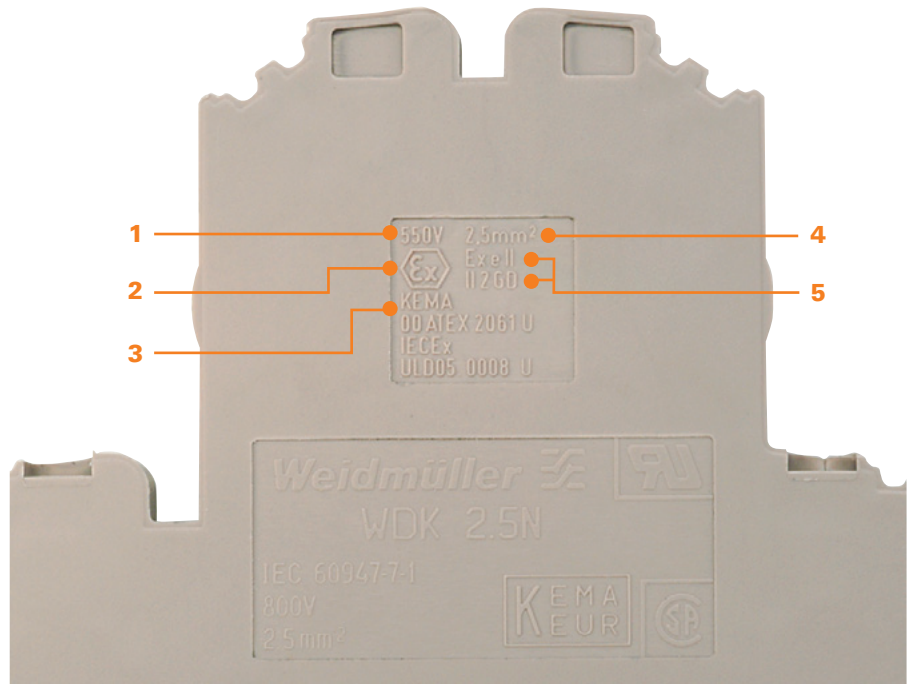

ATEX cross-connection instructions

Current versions can be found in our online product catalogue

Maximum voltage

Range ¹⁾	Certificate No.	Rated voltage / V	Rated current / A	Rated current with QV / A	Nominal cross-section / mm ²
AKZ...					
AKZ 1.5	SIRA 02ATEX3001 U	176	15	15	1.5
AKZ 2.5	SIRA 02ATEX3001 U	176	21	21	2.5
AKZ 4	SIRA 02ATEX3001 U	275	28	28	4
BK...					
BK 2/E ... BK 12/E	SIRA 01ATEX3247 U	275	28	25	4
DK 4 ...					
DK 4	SIRA 02ATEX3316 U	275	28	21	4
DK 4Q	SIRA 02ATEX3316 U	275	28	21	4
DK 4QV	SIRA 02ATEX3316 U	275	28	21	4
I ... Series					
IDK 1.5N	KEMA 02ATEX2241 U	275	15	15	1.5
IDK 1.5N/V	KEMA 02ATEX2241 U	275	15	15	1.5
IDU 1.5N	KEMA 02ATEX2241 U	275	15	15	1.5
IDU 1.5N/2X2AN	KEMA 02ATEX2241 U	275	15	15	1.5
IDU 1.5N/ZF	KEMA 02ATEX2241 U	275	15	15	1.5
IDU 1.5N/3AN/ZF	KEMA 02ATEX2241 U	275	15	15	1.5
IDU 1.5N/ZB	KEMA 02ATEX2241 U	275	15	15	1.5
IDU 1.5N/3AN/ZB	KEMA 02ATEX2241 U	275	15	15	1.5
IDU 2.5N	DEMKO 03ATEX134054 U	550	21	21	2.5
IDU 2.5N/3AN	DEMKO 03ATEX134054 U	550	21	21	2.5
IDU 2.5N/4AN	DEMKO 03ATEX134054 U	550	21	21	2.5
IDU 2.5N/2x2AN	DEMKO 03ATEX134054 U	550	21	21	2.5
IDU 2.5N/ZF	DEMKO 03ATEX134054 U	550	21	21	2.5
IDU 2.5N/ZB	DEMKO 03ATEX134054 U	550	21	21	2.5
MK ...					
MK 3/.../E	SIRA 01ATEX3248U	275	21	21	2.5
MK 6/.../E	SIRA 01ATEX3249U	440	36	36	6

¹⁾ Please refer to the catalogue and the certificate for details of precisely which article is approved.

Maximum voltage / V (letters refer to the above diagrams)							
A	C	D	E	F	G	H	I
176	176	-	176	176	-	-	-
176	176	-	176	176	-	-	-
275	275	-	275	275	-	-	-
176	-	-	-	-	-	-	-
275	275	-	275	275	-	-	-
275	275	-	275	275	-	-	-
275	275	-	275	275	-	-	-
275	275	275	-	-	-	-	-
275	275	275	-	-	-	-	-
275	275	275	275	275	275	275	-
275	275	275	275	275	275	275	-
275	275	275	275	275	275	275	-
275	275	275	275	275	275	275	275
550	550	550	550	550	550	-	-
550	550	550	550	550	550	-	-
550	550	550	550	550	550	-	-
550	550	550	550	550	550	-	-
550	550	275	550	550	275	-	-
550	550	275	550	550	275	-	-
176	-	-	-	-	-	-	-
275	-	-	-	-	-	-	-

Maximum voltage

Range ¹⁾	Certificate No.	Rated voltage / V	Rated current / A	Rated current with QV / A	Nominal cross-section / mm ²
P ...					
PDU 2.5/4	KEMA 06ATEX0177U	550	29	25.5	4
PDU 2.5/4/3AN	KEMA 06ATEX0177U	550	29	25.5	4
PDU 2.5/4/4AN	KEMA 06ATEX0177U	550	29	26.5	4
PDU 6/10	KEMA 06ATEX0177U	550	37	26.5	6
PDU 6/10/3AN	KEMA 06ATEX0177U	550	36.5	29.5	6
PDU 16	KEMA 06ATEX0177U	550	59	57.5	16
PEI 16	KEMA 06ATEX0177U	550	66.5	25 (37) ⁴⁾	16
SAK ...TS 32/TS 35					
SAK 2.5	KEMA 97ATEX1798 U	550	21	21	2.5
SAK 4	KEMA 97ATEX1798 U	550	28	28	4
SAK 6N	KEMA 97ATEX1798 U	550	36	36	6
SAK 10	KEMA 97ATEX1798 U	550	50	50	10
SAK 16	KEMA 97ATEX1798 U	690	66	66	16
SAK 35	KEMA 97ATEX1798 U	550	109	99	35
SAK ... EN on TS32					
SAK 2.5 EN	KEMA 97ATEX1798 U	440	21	21	2.5
SAK 4 EN	KEMA 97ATEX1798 U	440	28	28	4
SAK 6N EN	KEMA 97ATEX1798 U	440	36	36	6
SAK 10 EN	KEMA 97ATEX1798 U	440	50	50	10
SAK 16 EN	KEMA 97ATEX1798 U	440	66	66	16
SAK 35 EN	KEMA 97ATEX1798 U	440	109	109	35
SAK ... EN on TS35					
SAK 2.5 EN	KEMA 97ATEX1798 U	690	21	21	2.5
SAK 4 EN	KEMA 97ATEX1798 U	690	28	28	4
SAK 6N EN	KEMA 97ATEX1798 U	690	36	36	6
SAK 10 EN	KEMA 97ATEX1798 U	690	50	50	10
SAK 16 EN	KEMA 97ATEX1798 U	690	66	66	16
SAK 35 EN	KEMA 97ATEX1798 U	690	109	109	35
SAK 4 EP/SAKH 6-35 EP					
SAK 4 EP/SW	KEMA05ATEX2061U	550	32	32	4
SAKH 6 EP/SW	KEMA05ATEX2061U	1100	57	57	10
SAKH 10 EP/SW	KEMA05ATEX2061U	1100	57	57	10
SAKH 35 EP/SW	KEMA05ATEX2061U	1100	125	125	35
SAKK ...					
SAKK 4	SIRA 03 ATEX3425 U	275	28	28	4
SAKK 10	SIRA 03 ATEX3425 U	275	50	50	10
W ...					
WDK 1.5/R3.5	KEMA 99ATEX6545 U	275	14	11	1.5
WDK 2.5	KEMA 98ATEX1687 U	275	21	21	2.5
WDK 2.5V	KEMA 98ATEX1687 U	275	21	21	2.5
WDK 2.5DU-PE	KEMA 98ATEX1687 U	275	21	21	2.5
WDK 2.5/EX	KEMA 98ATEX1687 U	440	24	22	2.5
WDK 2.5N	KEMA 00ATEX2061 U	550	21	21	2.5
WDK 2.5N V	KEMA 00ATEX2061 U	550	21	21	2.5
WDK 4N	KEMA 00ATEX2061 U	550	28	28	4
WDK 4N V	KEMA 00ATEX2061 U	550	28	28	4
WDU 1.5/ZZ	KEMA 98ATEX1685 U	550	15	15	1.5
WDU 2.5/1.5/ZR	KEMA 98ATEX1685 U	550	15	15	1.5
WDU 1.5/R3.5	KEMA 99ATEX6545 U	275	15	11	1.5
WDU 2.5N	KEMA 98ATEX1683 U	440	21	21	2.5
WDU 2.5	KEMA 98ATEX1683 U	550	21	21	2.5
WDU 4	KEMA 98ATEX1683 U	690	28	28	4
WDU 4N	TÜV 04ATEX2630 U	440	27	27	4
WDU 6	KEMA 98ATEX1683 U	550	36	36	6
WDU 10	KEMA 98ATEX1683 U	550	50	50	10
WDU 16	KEMA 98ATEX1683 U	690	66	66	16
WDU 35	KEMA 98ATEX1683 U	690	109	109	35
WDU 50N	KEMA 98ATEX1683 U	690	126	126	50
WDU 70N	KEMA 98ATEX1683 U	690	167	167	70
WDU 70/95	KEMA 98ATEX1686 U	690	202	202	95

¹⁾ Please refer to the catalogue and the certificate for details of precisely which article is approved.⁴⁾ For PDU2.5/4 and ZDV 2.5 cross-connection: 25 A; For PDU 6/10 and ZDV 6N cross-connection: 37 A

Maximum voltage / V (letters refer to the above diagrams)							
A	C	D	E	F	G	H	I
275	550	176	275	275	176	176	
275	550	176	275	275	176	176	
275	550	176	275	275	176	176	
550	550	275	550	550	-	220	
550	550	275	550	550	-	220	
275	550	-	275	275	-	110	
275	-	-	-	-	-	-	
550	550	176	550	550	-	-	-
550	550	176	550	550	-	-	-
550	550	176	550	550	-	-	-
550	550	176	550	550	-	-	-
550	550	176	690	690	-	-	-
550	550	176	550	550	-	-	-
440	440	440	440	440	-	-	-
440	440	440	440	440	-	-	-
440	440	440	440	440	-	-	-
440	440	440	440	440	-	-	-
440	440	440	440	440	-	-	-
440	440	440	440	440	-	-	-
690	690	440	690	690	-	-	-
690	690	690	690	690	-	-	-
690	690	690	690	690	-	-	-
690	690	690	690	690	-	-	-
690	690	690	690	690	-	-	-
690	690	690	690	690	-	-	-
550	550	176	550	550	-	-	-
1100	1100	176	1100	1100	-	-	-
1100	1100	176	1100	1100	-	-	-
1100	1100	440	1100	1100	-	-	-
275	275	-	275	275	-	-	-
275	275	-	275	275	-	-	-
176	275	-	-	-	-	-	-
275	275	60	275	275	60	-	-
275	275	60	275	275	60	-	-
275	275	60	275	275	60	-	-
440	440	176	440	440	176	-	-
550	550	275	550	550	275	-	-
550	550	275	550	550	275	-	-
550	550	275	550	550	275	-	-
550	550	110	550	550	110	110	-
550	550	110	550	550	110	110	-
176	275	-	-	-	-	-	-
440	440	110	440	440	110	-	-
550	550	110	440	550	110	110 ²⁾	60 ³⁾
690	690	110	440	690	110	-	-
440	275	69	440	440	69	69	-
550	550	110	440	550	110	-	-
550	550	110	440	550	110	-	-
690	690	110	690	690	110	-	-
690	690	110	690	690	110	-	-
550	-	-	550	550	-	-	-
550	-	-	550	550	-	-	-
690	-	-	690	690	-	-	-

²⁾ The outer cross-connection openings must be used for type ZDV.³⁾ Only possible with ZDV.

Index

Index	Index Type	X.2
	Index Order No.	X.12
	Addresses worldwide	X.24

Type	Order No.	Page
A		
ADAPTER ALU STI-S	1762440000	F.39
ADL	0210800000	D.158
ADP 1/HP1 1M	0485200000	F.15
ADP 2/HP2 1M	0485300000	F.15
ADP 3/HP3 1M	0485400000	F.15
ADP 4/1000	1430760000	F.15
ADP 4/300	1378160000	F.15
ADP WF10/WF12	1780940000	D.147
ADP WF6/WF8	1780930000	D.144
AK 95	0364200000	F.5
AKE 2.5	1303360000	D.131
AKE 4	0380260000	D.131
AKKU DMS 3	9007450000	F.64
AKZ 1.5	0340460000	D.130
AKZ 1.5 BL	0340480000	D.130
AKZ 2.5	0697160000	D.130
AKZ 2.5 BL	0697180000	D.130
AKZ 4	0294360000	D.131
AKZ 4 BL	0294380000	D.131
AKZ 4/10	0359560000	D.182
AKZ 4/10/BEZ	0359560000	D.182
AM 16	9204190000	F.47
AMF 6/10	9204180000	F.47
AP 100 GR	1773410000	D.158
AP AKZ1.5	0340560000	D.130
AP AKZ1.5 BL	0340580000	D.130
AP AKZ2.5	0697360000	D.130
AP AKZ2.5 BL	0697380000	D.130
AP AKZ4	0294460000	D.131
AP AKZ4 BL	0294480000	D.131
AP AKZ4 DB	9537910000	D.158
AP AKZ4 KRG	0294420000	D.158
AP AKZ4 KRS	0294430000	D.158
AP DLD2.5 DB	1784210000	D.157
AP DLD2.5/PE DB	1783800000	D.157
AP DLD2.5 DB	1783850000	D.157
AP KDKS1 DB	9532470000	D.34
AP MAK2.5 DB	7917000000	D.96
AP VLI1.5 DB	1784150000	D.96
AP VLI1.5/PE DB	1784160000	D.158
AP WMF2.5	1142990000	D.112
AP ZDR2.5	1745420000	C.67
AP ZDR2.5 BL	1798340000	C.131
AP ZRV1.5 DB	1698180000	C.131
AP ZRV2.5	1906980000	C.95
B		
BA RC ZPS2.5	1908560000	C.105
BA ZPS2.5	1908550000	C.105
BEST	1833100000	D.178
BEST/D	1878560000	D.178
BEST/DRBR	1878570000	D.178
BEZ-KARTE ADP	0566700000	F.15
BFEH 1/W5H	1082400000	E.9
BFSC M3X22 SAKT4	1319900000	D.72
BFSC M4X30	0267100000	F.4
BFSC M4X9T	0103300000	F.4
BFSC M5X8 Schlitz	0296700000	F.3
BK 12 CRN	0625320000	D.137
BK 12/E	7906100000	D.138
BK 2 CRN	0624720000	D.137
BK 2/E	7906040000	D.138
BK 3 CRN	0624920000	D.137
BK 3/E	7906060000	D.138
BK 4 CRN	0625120000	D.137
BK 4/E	7906080000	D.138
BK 6 CRN	0625220000	D.137
BK 6/E	7906090000	D.138
BLZ 5.08/04/180 SN OR BX	1526660000	D.100
BLZ 5.08/04/180B SN OR BX	1528960000	D.100
BLZ 5.08/06/180 SN OR BX	1526680000	D.100
BLZ 5.08/06/180B SN OR BX	1529160000	D.100
BLZ 5.08/08/180 SN OR BX	1527060000	D.100
BLZ 5.08/08/180B SN OR BX	1529360000	D.100
BLZ/SL KO SW	1545710000	D.100
BLZP 5.08/02/90 SN BK BX	1948240000	D.112
BLZP 5.08/02/90 SN OR BX	1948000000	D.112
BLZP 5.08/02/90F SN BK BX	1950040000	D.112
BLZP 5.08/02/90F SN OR BX	1949800000	D.112
BLZP 5.08/04/90 SN BK BX	1948260000	D.112
BLZP 5.08/04/90 SN OR BX	1948020000	D.112
BLZP 5.08/04/90F SN BK BX	1950060000	D.112
BLZP 5.08/04/90F SN OR BX	1949820000	D.112
BLZP 5.08/08/90 SN BK BX	1948300000	D.112
BLZP 5.08/08/90 SN OR BX	1948060000	D.112
BLZP 5.08/08/90F SN BK BX	1950100000	D.112
BLZP 5.08/08/90F SN OR BX	1949860000	D.112
BLZP 5.08/12/90 SN BK BX	1948340000	D.112
BLZP 5.08/12/90 SN OR BX	1948110000	D.112
BLZP 5.08/12/90F SN BK BX	1950140000	D.112
BLZP 5.08/12/90F SN OR BX	1949900000	D.112
BLZP 5.08/16/90 SN BK BX	1948380000	D.112
BLZP 5.08/16/90 SN OR BX	1948150000	D.112
BLZP 5.08/16/90F SN BK BX	1950180000	D.112
BLZP 5.08/16/90F SN OR BX	1949940000	D.112
BS 25 IH/BL SAKT1	0335400000	D.71

Type	Order No.	Page
BS 25 IH/GE SAKT1	0335700000	D.71
BS 25 IH/GN SAKT1	0335600000	D.71
BS 25 IH/GR SAKT1	0335300000	D.71
BS 25 IH/RT SAKT1	0335500000	D.71
BS 25 IH/SW SAKT1	0335200000	D.71
BS 25 IH/VI SAKT1	0335800000	D.71
BS 25 O.IH SAKT1	0334700000	D.71
BS 35/W5H 2	1760720000	E.9
BS 35II KLBUE HOLDER	1723800000	E.12
BS 35II KLBUE2X3-8/2X2-6	1768020000	E.12
BS 35II KLBUE3-8	1723810000	E.12
BS 35II KLBUE3-8/2X2-6	1749430000	E.12
BS 35II/KLBUE 4-13.5	1723820000	E.12
BSTB 28/12 BK U 1-12	0198800000	D.137
BSTB 28/12 MK U 1-12	0245800000	D.134
BSTB 28/12/6.35 O 1-12	0278500000	D.134
BSTB 28/12/6.35 U 1-12	0245700000	D.134
BSTB 28/16 MK U 1-16	0262200000	D.135
BSTB 28/2 BK U 1-2	0203600000	D.137
BSTB 28/4 BK U 1-4	0197300000	D.137
BSTB 28/6 BK U 1-6	0197500000	D.137
BSTB 28/6 MK U 1-6	0290000000	D.134
BSTB 28/8 MK U 1-8	0290200000	D.134
BSTO 28/12 BK	0198700000	D.137
BSTO 28/12 MK	0245800000	D.134
BSTO 28/16 MK 4/16	0262100000	D.135
BSTO 28/2 BK	0203600000	D.137
BSTO 28/3 BK	0203700000	D.137
BSTO 28/4 BK	0197200000	D.137
BSTO 28/4 MK3/4	0289300000	D.134
BSTO 28/6 BK	0197400000	D.137
BSTO 28/6 MK	0289500000	D.134
BSTO 28/8 MK3/8	0284700000	D.134
BTWZ KLBUE	1742630000	E.11
BZT 1 WS 10/5	1805490000	F.30
BZT 1 ZA WS 10/5	1805520000	F.30
BZT 2 WS 10/5	1805480000	F.30
BZT 2 ZA WS 10/5	1805530000	F.30
BZT PRV16 BL 35X15	1267930000	B.40
BZT PRV16 BL 35X7.5	1267940000	B.40
BZT PRV16 SW 35X15	1173540000	B.40
BZT PRV16 SW 35X7.5	1173550000	B.40
BZT PRV4 BL 35X15	1267980000	B.38
BZT PRV4 BL 35X7.5	1267990000	B.38
BZT PRV4 SW 35X15	1173590000	B.38
BZT PRV4 SW 35X7.5	1173600000	B.38
BZT PRV8 BL 35X15	1267950000	B.39
BZT PRV8 BL 35X7.5	1267970000	B.39
BZT PRV8 SW 35X15	1173570000	B.39
BZT PRV8 SW 35X7.5	1173580000	B.39
BZT ZTL6	1781140000	C.68
BZT ZVL1.5	1676610000	C.111
BZT ZVL1.5/0.ZA	1676620000	C.111
C		
CleanUnit PrintJet II	1858950000	F.36
CRIMP-SET PZ 16	9025850000	B.53
CRIMP-SET PZ 6 ROTO	9028680000	B.53
CROSS-KEY MASTER	9918150000	F.63
CROSS-KEY UNIVERSAL	9918130000	F.63
CROSS-KEY UNIVERSAL S	9918140000	F.63
CTI 6	9006120000	F.65
CTI 6 G	9202850000	F.65
D		
D 2 MK5/2 PA/NA	0244060000	D.136
D10 KS10 TP	0141800000	D.136
D2 KS2 TP	0134500000	D.136
D4 KS4 TP	0140500000	D.136
D6 KS6 TP	0140800000	D.136
DEK 5 BL NEUTRAL	0473391693	F.21
DEK 5 BR NEUTRAL	0473391692	F.21
DEK 5 FS 1-50	0473560001	F.21
DEK 5 FS 101-150	0473560101	F.21
DEK 5 FS 151-200	0473560151	F.21
DEK 5 FS 201-250	0473560201	F.21
DEK 5 FS 251-300	0473560251	F.21
DEK 5 FS 301-350	0473560301	F.21
DEK 5 FS 351-400	0473560351	F.21
DEK 5 FS 401-450	0473560401	F.21
DEK 5 FS 451-500	0473560451	F.21
DEK 5 FS 501-550	0473560501	F.21
DEK 5 FS 51-100	0473560051	F.21
DEK 5 FS 551-600	0473560551	F.21
DEK 5 FS 601-650	0473560601	F.21
DEK 5 FS 651-700	0473560651	F.21
DEK 5 FS 701-750	0473560701	F.21
DEK 5 FS 751-800	0473560751	F.21
DEK 5 FS 801-850	0473560801	F.21
DEK 5 FS 851-900	0473560851	F.21
DEK 5 FS 901-950	0473560901	F.21
DEK 5 FS 951-999	0473560951	F.21
DEK 5 FSZ 1-10	0406060001	F.21
DEK 5 FSZ 11-20	0406060011	F.21
DEK 5 FSZ 21-30	0406060021	F.21
DEK 5 FSZ 31-40	0406060031	F.21
DEK 5 FSZ 41-50	0406060041	F.21

Type	Order No.	Page
DEK 5 FSZ 51-60	0406060051	F.21
DEK 5 FSZ 61-70	0406060061	F.21
DEK 5 FSZ 71-80	0406060071	F.21
DEK 5 FSZ 81-90	0406060081	F.21
DEK 5 FSZ 91-100	0406060091	F.21
DEK 5 FW 1-50	0473460001	F.21
DEK 5 FW 1,3,5...99	1358460000	F.21
DEK 5 FW 10-500	0132660010	F.21
DEK 5 FW 101-150	0473460101	F.21
DEK 5 FW 151-200	0473460151	F.21
DEK 5 FW 2,4...100	1358560000	F.21
DEK 5 FW 201-250	0473460201	F.21
DEK 5 FW 251-300	0473460251	F.21
DEK 5 FW 301-350	0473460301	F.21
DEK 5 FW 351-400	0473460351	F.21
DEK 5 FW 401-450	0473460401	F.21
DEK 5 FW 451-500	0473460451	F.21
DEK 5 FW 501-550	0473460501	F.21
DEK 5 FW 51-100	0473460051	F.21
DEK 5 FW 551-600	0473460551	F.21
DEK 5 FW 601-650	0473460601	F.21
DEK 5 FW 651-700	0473460651	F.21
DEK 5 FW 701-750	0473460701	F.21
DEK 5 FW 751-800	0473460751	F.21
DEK 5 FW 801-850	0473460801	F.21
DEK 5 FW 851-900	0473460851	F.21
DEK 5 FW 901-950	0473460901	F.21
DEK 5 FW 951-999	0473460951	F.21
DEK 5 FW U1-PE1	0133161114	F.21
DEK 5 FW U2-PE2	0133161115	F.21
DEK 5 FW U3-PE3	0133161116	F.21
DEK 5 FW U4-PE4	0133161117	F.21
DEK 5 FW U5-PE5	0133161118	F.21
DEK 5 FW U6-PE6	0133161119	F.21
DEK 5 FW U7-PE7	0133161120	F.21
DEK 5 FW U8-PE8	0133161121	F.21
DEK 5 FW U9-PE9	0133161122	F.21
DEK 5 FW X1-Z1	0133261150	F.21
DEK 5 FW X10-Z10	0133261159	F.21
DEK 5 FW X2-Z2	0133261151	F.21
DEK 5 FW X3-Z3	0133261152	F.21
DEK 5 FW X4-Z4	0133261153	F.21
DEK 5 FW X5-Z5	0133261154	F.21
DEK 5 FW X6-Z6	0133261155	F.21
DEK 5 FW X7-Z7	0133261156	F.21
DEK 5 FW X8-Z8	0133261157	F.21
DEK 5 FW X9-Z9	0133261158	F.21
DEK 5 FWZ 1-10	0523060001	F.21
DEK 5 FWZ 1-9	1672000000	F.21
DEK 5 FWZ 1,3,5-19	0235860000	F.21
DEK 5 FWZ 11-20	0523060011	F.21
DEK 5 FWZ 2,4,6-20	0236160000	F.21
DEK 5 FWZ 21-30	0523060021	F.21
DEK 5 FWZ 21,23,25-39	0235960000	F.21
DEK 5 FWZ 22,24,26-40	0236260000	F.21
DEK 5 FWZ 31-40	0523060031	F.21
DEK 5 FWZ 41-50	0523060041	F.21
DEK 5 FWZ 41,43,45-59	0236060000	F.21

Type	Order No.	Page	Type	Order No.	Page	Type	Order No.	Page	Type	Order No.	Page
DEK 5 GW 186	0522660186	F.22	DEK 5 GW 95	0522660095	F.21	DEK 5/8 PLUS MC SDR	1046370000	F.25	DEK 6 GW 2	0526960002	F.22
DEK 5 GW 187	0522660187	F.22	DEK 5 GW 96	0522660096	F.21	DEK 6 BL NEUTRAL	0468591693	F.22	DEK 6 GW 20	0526960020	F.22
DEK 5 GW 188	0522660188	F.22	DEK 5 GW 97	0522660097	F.21	DEK 6 BR NEUTRAL	0468591692	F.22	DEK 6 GW 21	0526960021	F.22
DEK 5 GW 189	0522660189	F.22	DEK 5 GW 98	0522660098	F.21	DEK 6 FS 1-50	0468760001	F.22	DEK 6 GW 22	0526960022	F.22
DEK 5 GW 19	0522660019	F.21	DEK 5 GW 99	0522660099	F.21	DEK 6 FS 101-150	0468760101	F.22	DEK 6 GW 23	0526960023	F.22
DEK 5 GW 190	0522660190	F.22	DEK 5 GW A	0522761021	F.22	DEK 6 FS 151-200	0468760151	F.22	DEK 6 GW 24	0526960024	F.22
DEK 5 GW 191	0522660191	F.22	DEK 5 GW B	0522761022	F.22	DEK 6 FS 201-250	0468760201	F.22	DEK 6 GW 25	0526960025	F.22
DEK 5 GW 192	0522660192	F.22	DEK 5 GW BL/SW -	0576291741	F.22	DEK 6 FS 251-300	0468760251	F.22	DEK 6 GW 26	0526960026	F.22
DEK 5 GW 193	0522660193	F.22	DEK 5 GW C	0522761023	F.22	DEK 6 FS 301-350	0468760301	F.22	DEK 6 GW 27	0526960027	F.22
DEK 5 GW 194	0522660194	F.22	DEK 5 GW D	0522761024	F.22	DEK 6 FS 351-400	0468760351	F.22	DEK 6 GW 28	0526960028	F.22
DEK 5 GW 195	0522660195	F.22	DEK 5 GW E	0522761025	F.22	DEK 6 FS 401-450	0468760401	F.22	DEK 6 GW 29	0526960029	F.22
DEK 5 GW 196	0522660196	F.22	DEK 5 GW ERDE	0576261202	F.22	DEK 6 FS 451-500	0468760451	F.22	DEK 6 GW 30	0526960030	F.22
DEK 5 GW 197	0522660197	F.22	DEK 5 GW ERDE I.K.R.	0576261203	F.22	DEK 6 FS 501-550	0468760501	F.22	DEK 6 GW 31	0526960031	F.22
DEK 5 GW 198	0522660198	F.22	DEK 5 GW F	0522761026	F.22	DEK 6 FS 51-100	0468760051	F.22	DEK 6 GW 32	0526960032	F.22
DEK 5 GW 199	0522660199	F.22	DEK 5 GW G	0522761027	F.22	DEK 6 FS 551-600	0468760551	F.22	DEK 6 GW 33	0526960033	F.22
DEK 5 GW 2	0522660002	F.21	DEK 5 GW H	0522761028	F.22	DEK 6 FS 601-650	0468760601	F.22	DEK 6 GW 34	0526960034	F.22
DEK 5 GW 20	0522660020	F.21	DEK 5 GW I	0522761029	F.22	DEK 6 FS 651-700	0468760651	F.22	DEK 6 GW 35	0526960035	F.22
DEK 5 GW 200	0522660200	F.22	DEK 5 GW J	0522761030	F.22	DEK 6 FS 701-750	0468760701	F.22	DEK 6 GW 36	0526960036	F.22
DEK 5 GW 21	0522660021	F.21	DEK 5 GW K	0522761031	F.22	DEK 6 FS 751-800	0468760751	F.22	DEK 6 GW 37	0526960037	F.22
DEK 5 GW 22	0522660022	F.21	DEK 5 GW L	0522761032	F.22	DEK 6 FS 801-850	0468760801	F.22	DEK 6 GW 38	0526960038	F.22
DEK 5 GW 23	0522660023	F.21	DEK 5 GW L1	0522361075	F.22	DEK 6 FS 851-900	0468760851	F.22	DEK 6 GW 39	0526960039	F.22
DEK 5 GW 24	0522660024	F.21	DEK 5 GW L2	0522361076	F.22	DEK 6 FS 901-950	0468760901	F.22	DEK 6 GW 40	0526960040	F.22
DEK 5 GW 25	0522660025	F.21	DEK 5 GW L3	0522361077	F.22	DEK 6 FS 951-999	0468760951	F.22	DEK 6 GW 41	0526960041	F.22
DEK 5 GW 26	0522660026	F.21	DEK 5 GW M	0522761033	F.22	DEK 6 FSZ 1-10	0133360001	F.22	DEK 6 GW 42	0526960042	F.22
DEK 5 GW 27	0522660027	F.21	DEK 5 GW Mp	0537261235	F.22	DEK 6 FSZ 11-20	0133360011	F.22	DEK 6 GW 43	0526960043	F.22
DEK 5 GW 28	0522660028	F.21	DEK 5 GW N	0522761034	F.22	DEK 6 FSZ 21-30	0133360021	F.22	DEK 6 GW 44	0526960044	F.22
DEK 5 GW 29	0522660029	F.21	DEK 5 GW O	0522761035	F.22	DEK 6 FSZ 31-40	0133360031	F.22	DEK 6 GW 45	0526960045	F.22
DEK 5 GW 3	0522660003	F.21	DEK 5 GW P	0522761036	F.22	DEK 6 FSZ 41-50	0133360041	F.22	DEK 6 GW 46	0526960046	F.22
DEK 5 GW 30	0522660030	F.21	DEK 5 GW PE	0537261187	F.22	DEK 6 FSZ 51-60	0133360051	F.22	DEK 6 GW 47	0526960047	F.22
DEK 5 GW 31	0522660031	F.21	DEK 5 GW PEN	0537261188	F.22	DEK 6 FSZ 61-70	0133360061	F.22	DEK 6 GW 48	0526960048	F.22
DEK 5 GW 32	0522660032	F.21	DEK 5 GW Q	0522761037	F.22	DEK 6 FSZ 71-80	0133360071	F.22	DEK 6 GW 49	0526960049	F.22
DEK 5 GW 33	0522660033	F.21	DEK 5 GW R	0522761038	F.22	DEK 6 FSZ 81-90	0133360081	F.22	DEK 6 GW 50	0526960050	F.22
DEK 5 GW 34	0522660034	F.21	DEK 5 GW RT/SW +	0576291737	F.22	DEK 6 FSZ 91-100	0133360091	F.22	DEK 6 GW 51	0526960051	F.22
DEK 5 GW 35	0522660035	F.21	DEK 5 GW S	0522761039	F.22	DEK 6 FW 1-5 (10X)	0688660000	F.22	DEK 6 GW 52	0526960052	F.22
DEK 5 GW 36	0522660036	F.21	DEK 5 GW T	0522761040	F.22	DEK 6 FW 1-50	0468660001	F.22	DEK 6 GW 53	0526960053	F.22
DEK 5 GW 37	0522660037	F.21	DEK 5 GW U	0522761041	F.22	DEK 6 FW 1,3,5...99	1358660000	F.22	DEK 6 GW 54	0526960054	F.22
DEK 5 GW 38	0522660038	F.21	DEK 5 GW V	0522761042	F.22	DEK 6 FW 101-150	0468660101	F.22	DEK 6 GW 55	0526960055	F.22
DEK 5 GW 39	0522660039	F.21	DEK 5 GW W	0522761043	F.22	DEK 6 FW 151-200	0468660151	F.22	DEK 6 GW 56	0526960056	F.22
DEK 5 GW 4	0522660004	F.21	DEK 5 GW W-STROM	0576261215	F.22	DEK 6 FW 2,4...100	1358760000	F.22	DEK 6 GW 57	0526960057	F.22
DEK 5 GW 40	0522660040	F.21	DEK 5 GW X	0522761044	F.22	DEK 6 FW 201-250	0468660201	F.22	DEK 6 GW 58	0526960058	F.22
DEK 5 GW 41	0522660041	F.21	DEK 5 GW Y	0522761045	F.22	DEK 6 FW 251-300	0468660251	F.22	DEK 6 GW 59	0526960059	F.22
DEK 5 GW 42	0522660042	F.21	DEK 5 GW Z	0522761046	F.22	DEK 6 FW 301-350	0468660301	F.22	DEK 6 GW 60	0526960060	F.22
DEK 5 GW 43	0522660043	F.21	DEK 5 NEUTRAL	0473360000	F.22	DEK 6 FW 351-400	0468660351	F.22	DEK 6 GW 61	0526960061	F.22
DEK 5 GW 44	0522660044	F.21	DEK 5 OR NEUTRAL	0473391690	F.22	DEK 6 FW 401-450	0468660401	F.22	DEK 6 GW 62	0526960062	F.22
DEK 5 GW 45	0522660045	F.21	DEK 5 RT NEUTRAL	0473391686	F.22	DEK 6 FW 451-500	0468660451	F.22	DEK 6 GW 63	0526960063	F.22
DEK 5 GW 46	0522660046	F.21	DEK 5 SW NEUTRAL	0473391694	F.22	DEK 6 FW 501-550	0468660501	F.22	DEK 6 GW 64	0526960064	F.22
DEK 5 GW 47	0522660047	F.21	DEK 5 VI NEUTRAL	0473391689	F.22	DEK 6 FW 51-100	0468660051	F.22	DEK 6 GW 65	0526960065	F.22
DEK 5 GW 48	0522660048	F.21	DEK 5/3,5 MC bedruckt	1767730000	F.25	DEK 6 FW 551-600	0468660551	F.22	DEK 6 GW 66	0526960066	F.22
DEK 5 GW 49	0522660049	F.21	DEK 5/3,5 MC FSZ 1-10	1762320101	F.22	DEK 6 FW 601-650	0468660601	F.22	DEK 6 GW 67	0526960067	F.22
DEK 5 GW 5	0522660005	F.21	DEK 5/3,5 MC FSZ 101-110	1762320101	F.22	DEK 6 FW 651-700	0468660651	F.22	DEK 6 GW 68	0526960068	F.22
DEK 5 GW 50	0522660050	F.21	DEK 5/3,5 MC FSZ 11-20	1762320111	F.22	DEK 6 FW 701-750	0468660701	F.22	DEK 6 GW 69	0526960069	F.22
DEK 5 GW 51	0522660051	F.21	DEK 5/3,5 MC FSZ 111-120	1762320111	F.22	DEK 6 FW 751-800	0468660751	F.22	DEK 6 GW 70	0526960070	F.22
DEK 5 GW 52	0522660052	F.21	DEK 5/3,5 MC FSZ 121-130	1762320121	F.22	DEK 6 FW 801-850	0468660801	F.22	DEK 6 GW 71	0526960071	F.22
DEK 5 GW 53	0522660053	F.21	DEK 5/3,5 MC FSZ 131-140	1762320131	F.22	DEK 6 FW 851-900	0468660851	F.22	DEK 6 GW 72	0526960072	F.22
DEK 5 GW 54	0522660054	F.21	DEK 5/3,5 MC FSZ 141-150	1762320141	F.22	DEK 6 FW 901-950	0468660901	F.22	DEK 6 GW 73	0526960073	F.22
DEK 5 GW 55	0522660055	F.21	DEK 5/3,5 MC FSZ 21-30	1762320021	F.22	DEK 6 FW 951-999	0468660951	F.22	DEK 6 GW 74	0526960074	F.22
DEK 5 GW 56	0522660056	F.21	DEK 5/3,5 MC FSZ 31-40	1762320031	F.22	DEK 6 FW 1-50	0632560000	F.22	DEK 6 GW 75	0526960075	F.22
DEK 5 GW 57	0522660057	F.21	DEK 5/3,5 MC FSZ 41-50	1762320041	F.22	DEK 6 FWZ 1-10	0518960001	F.22	DEK 6 GW 76	0526960076	F.22
DEK 5 GW 58	0522660058	F.21	DEK 5/3,5 MC FSZ 51-60	1762320051	F.22	DEK 6 FWZ 101-110	0518960101	F.22	DEK 6 GW 77	0526960077	F.22
DEK 5 GW 59	0522660059	F.21	DEK 5/3,5 MC FSZ 61-70	1762320061	F.22	DEK 6 FWZ 11-20	0518960011	F.22	DEK 6 GW 78	0526960078	F.22
DEK 5 GW 6	0522660006	F.21	DEK 5/3,5 MC FSZ 71-80	1762320071	F.22	DEK 6 FWZ 111-120	0518960111	F.22	DEK 6 GW 79	0526960079	F.22
DEK 5 GW 60	0522660060	F.21	DEK 5/3,5 MC FSZ 81-90	1762320081	F.22	DEK 6 FWZ 121-130	0518960121	F.22	DEK 6 GW 80	0526960080	F.22
DEK 5 GW 61	0522660061	F.21	DEK 5/3,5 MC FSZ 91-100	1762320091	F.22	DEK 6 FWZ 131-140	0518960131	F.22	DEK 6 GW 81	0526960081	F.22
DEK 5 GW 62	0522660062	F.21	DEK 5/3,5 MC GW 0	1755280000	F.22	DEK 6 FWZ 141-150	0518960141	F.22	DEK 6 GW 82	0526960082	F.22
DEK 5 GW 63	0522660063	F.21	DEK 5/3,5 MC GW 1	1755280001	F.22	DEK 6 FWZ 151-160	0518960151	F.22	DEK 6 GW 83	0526960083	F.22
DEK 5 GW 64	0522660064	F.21	DEK 5/3,5 MC GW 2	1755280002	F.22	DEK 6 FWZ 161-170	0518960161	F.22	DEK 6 GW 84	0526960084	F.22
DEK 5 GW 65	0522660065	F.21	DEK 5/3,5 MC GW 3	1755280003	F.22	DEK 6 FWZ 171-180	0518960171	F.22	DEK 6 GW 85	0526960085	F.22
DEK 5 GW 66	0522660066	F.21	DEK 5/3,5 MC GW 4	1755280004	F.22	DEK 6 FWZ 181-190	0518960181	F.22	DEK 6 GW 86	0526960086	F.22
DEK 5 GW 67	0522660067	F.21	DEK 5/3,5 MC GW 5	1755280005	F.22	DEK 6 FWZ 191-200	0518960191	F.22	DEK 6 GW 87	0526960087	F.22
DEK 5 GW 68	0522660068	F.21	DEK 5/3,5 MC GW 6	1755280006	F.22	DEK 6 FWZ 201-210	0518960201	F.22	DEK 6 GW 88	0526960088	F.22
DEK 5 GW 69	0522660069	F.21	DEK 5/3,5 MC GW 7	1755280007	F.22	DEK 6 FWZ 21-30	0518960021	F.22	DEK 6 GW 89	0526960089	F.22
DEK 5 GW 7	0522660007	F.21	DEK 5/3,5 MC GW 8	1755280008	F.22	DEK 6 FWZ 31-40	0518960031	F.22	DEK 6 GW 90	0526960090	F.22
DEK 5 GW 70	0522660070	F.21	DEK 5/3,5 MC GW 9	1755280009	F.22	DEK 6 FWZ 41-50	0518960041	F.22	DEK 6 GW 91	0526960091	F.22
DEK 5 GW 71	0522660071	F.21	DEK 5/3,5 MC NEUTRAL	1755270000	F.25	DEK 6 FWZ 51-60	0518960051	F.22	DEK 6 GW 92	0526960092	F.22
DEK 5 GW 72	0522660072	F.21	DEK 5/30 MC NEUTRAL	1951920000	F.33	DEK 6 FWZ 61-70	0518960061	F.22	DEK 6 GW 93	0526960093	F.22
DEK 5 GW 73	0522660073	F.21	DEK 5/30 MC SDR	1025680000	F.33	DEK 6 FWZ 71-80	0518960071	F.22	DEK 6 GW 94	0526960094	F.22
DEK 5 GW 74	0522660074	F.21	DEK 5/5 MC BEDRUCKT	1609801000	F.25	DEK 6 FWZ 81-90	0518960081	F.22	DEK 6 GW 95	0526960095	F.22
DEK 5 GW 75	0522660075	F.21	DEK 5/5 MC-10 NEUT. BL	1609801693	F.25	DEK 6 FWZ 91-100	0518960091	F.22	DEK 6 GW 96	0526960096	F.22
DEK 5 GW 76	0522660076	F.21	DEK 5/5 MC-10 NEUT. GE	1609801687	F.25	DEK 6 FWZ L1					

Type	Order No.	Page
DEK 6,5 FS 101-150	0468260101	F.23
DEK 6,5 FS 51-100	0468260051	F.23
DEK 6,5 FSZ 1-10	0407360001	F.23
DEK 6,5 FSZ 11-20	0407360011	F.23
DEK 6,5 FSZ 21-30	0407360021	F.23
DEK 6,5 FSZ 31-40	0407360031	F.23
DEK 6,5 FSZ 41-50	0407360041	F.23
DEK 6,5 FSZ 51-60	0407360051	F.23
DEK 6,5 FSZ 61-70	0407360061	F.23
DEK 6,5 FSZ 71-80	0407360071	F.23
DEK 6,5 FSZ 81-90	0407360081	F.23
DEK 6,5 FSZ 91-100	0407360091	F.23
DEK 6,5 FW 1-50	0468160001	F.23
DEK 6,5 FW 101-150	0468160101	F.23
DEK 6,5 FW 151-200	0468160151	F.23
DEK 6,5 FW 201-250	0468160201	F.23
DEK 6,5 FW 251-300	0468160251	F.23
DEK 6,5 FW 301-350	0468160301	F.23
DEK 6,5 FW 351-400	0468160351	F.23
DEK 6,5 FW 401-450	0468160401	F.23
DEK 6,5 FW 451-500	0468160451	F.23
DEK 6,5 FW 501-550	0468160501	F.23
DEK 6,5 FW 51-100	0468160051	F.23
DEK 6,5 FW L1-ERDE LKR	0632161203	F.23
DEK 6,5 FW L1-PE	0632161187	F.23
DEK 6,5 FWZ 1-10	0519060001	F.23
DEK 6,5 FWZ 11-20	0519060011	F.23
DEK 6,5 FWZ 21-30	0519060021	F.23
DEK 6,5 FWZ 31-40	0519060031	F.23
DEK 6,5 FWZ 41-50	0519060041	F.23
DEK 6,5 FWZ 51-60	0519060051	F.23
DEK 6,5 FWZ 61-70	0519060061	F.23
DEK 6,5 FWZ 71-80	0519060071	F.23
DEK 6,5 FWZ 81-90	0519060081	F.23
DEK 6,5 FWZ 91-100	0519060091	F.23
DEK 6,5 FWZ R,S,T,NERD	0632060000	F.23
DEK 6,5 BL NEUTRAL	0468091693	F.23
DEK 6,5 GE NEUTRAL	0468091687	F.23
DEK 6,5 GN NEUTRAL	0468091688	F.23
DEK 6,5 NEUTRAL	0468060000	F.23
DEK 6,5 OR NEUTRAL	0468091690	F.23
DEK 6,5 RT NEUTRAL	0468091696	F.23
DEK 6,5 SW NEUTRAL	0468091694	F.23
DEK 6,5 VI NEUTRAL	0468091689	F.23
DEK 6 BEDR./FARBIG	1289690000	F.23
DEK 6 FS 1-50 TAMPOPR.	1653300001	F.23
DEK 6 FS 51-100 TAMPOPR.	1653300051	F.23
DEK 6 FSZ 1-10	1289660001	F.23
DEK 6 FSZ 11-20	1289660011	F.23
DEK 6 FSZ 21-30	1289660021	F.23
DEK 6 FSZ 31-40	1289660031	F.23
DEK 6 FSZ 41-50	1289660041	F.23
DEK 6 FSZ 51-60	1289660051	F.23
DEK 6 FSZ 61-70	1289660061	F.23
DEK 6 FSZ 71-80	1289660071	F.23
DEK 6 FSZ 81-90	1289660081	F.23
DEK 6 FSZ 91-100	1289660091	F.23
DEK 6 FW 1-50 TAMPOPR.	1653340001	F.23
DEK 6 FW 51-100 TAMPOPR.	1653340051	F.23
DEK 6 FWZ 1-10	1278960001	F.23
DEK 6 FWZ 101-110	1278960101	F.23
DEK 6 FWZ 11-20	1278960011	F.23
DEK 6 FWZ 111-120	1278960111	F.23
DEK 6 FWZ 121-130	1278960121	F.23
DEK 6 FWZ 131-140	1278960131	F.23
DEK 6 FWZ 141-150	1278960141	F.23
DEK 6 FWZ 21-30	1278960021	F.23
DEK 6 FWZ 31-40	1278960031	F.23
DEK 6 FWZ 41-50	1278960041	F.23
DEK 6 FWZ 51-60	1278960051	F.23
DEK 6 FWZ 61-70	1278960061	F.23
DEK 6 FWZ 71-80	1278960071	F.23
DEK 6 FWZ 81-90	1278960081	F.23
DEK 6 FWZ 91-100	1278960091	F.23
DEK 6 GE NEUTRAL	1277091687	F.23
DEK 6 GN NEUTRAL	1277091688	F.23
DEK 6 NEUTRAL	1277060000	F.23
DEK 6 OR NEUTRAL	1277091690	F.23
DEK 6 RT NEUTRAL	1277091696	F.23
DEK 6 SONDERDR.WEISS	1326660000	F.23
DEK 6 VI NEUTRAL	1277091689	F.23
DFFC 5-1.0 ZRV1.5	1705320000	C.94
DFFC 0.2-0.35 ZRV1.5	1705310000	C.94
DKSUE NSCH/ESCH	0280100000	F.3
DLA 2.5 DB	1783560000	D.94
DLA 2.5/D DB	1783590000	D.94
DLA 2.5/LD-GN/D DB	1783630000	D.95
DLA 2.5/LD-RT DB	1783600000	D.95
DLD 2.5 DB	1784180000	D.92
DLD 2.5/PE DB	1783790000	D.92
DLU 2.5 DB	1783820000	D.93
DLU 2.5/LD-GN/NPN +> DB	1783940000	D.93
DLU 2.5/LD-GN/PNP +> DB	1783970000	D.93
DLU 2.5/LD-RT/NPN +> DB	1783950000	D.93
DLU 2.5/LD-RT/PNP +> DB	1783980000	D.93
DMS 3	9007440000	F.64
DMS 3 SET 1	9007470000	F.64
DMS 3 SET 2	9007480000	F.64
DMS MANUELL 0,5-1,7	9918370000	F.61

Type	Order No.	Page
DMS MANUELL 2,0-8,0	9918380000	F.61
DMSI MANUELL 0,5-1,7	9918390000	F.62
DMSI MANUELL 2,0-8,0	9918400000	F.62
DS 13.5 WTL6/4FF	1897000000	D.76

E

Type	Order No.	Page
E 14/10A RT	0328400000	D.48
E 14/16A GR	0328500000	D.52
E 14/2A RS	0137400000	D.48
E 14/4A BR	0137500000	D.48
E 14/6A GN	0328300000	D.48
E 16/10A RT TNDZ	0208500000	D.48
E 16/16A GR TNDZ	0208600000	D.48
E 16/20A BL TNDZ	0208700000	D.48
E 16/25A GE TNDZ	0208800000	D.48
E 18/20A BL	0361300000	D.49
E 18/25A GE	0361400000	D.49
E 18/35A SW	0361500000	D.49
E 18/50A WS	0361600000	D.52
E 18/63A KU	0361700000	D.52
ELS 16/40 MC GE	1045630000	F.31
ELS 16/40 MC SDR	1045690000	F.32
ELS 16/40 MC WS	1045620000	F.31
ELS 6/30 MC GE	1045580000	F.32
ELS 6/30 MC SDR	1045660000	F.32
ELS 6/30 MC WS	1045570000	F.32
ELS 7/40 MC GE	1045650000	F.31
ELS 7/40 MC SDR	1045700000	F.32
ELS 7/40 MC WS	1045640000	F.31
ELSB 10 BEZ. 1-10	0143500000	D.136
ELSB 2 BEZ. 1-2	0143200000	D.136
EM 8/30	1806120000	F.33
EMC-CONTACT	1067520000	E.14
EMC-SET	1067470000	E.14
EMC-TIE	1067490000	E.14
ERME 10° SPX 4	1119030000	F.48
ERME 16° SPX 4	1119040000	F.48
ERME AM 16	9204260000	F.47
ERME AMF 6/10	9204250000	F.47
ERME KT 45 R	9204270000	F.46
ERME KT 55	9204280000	F.46
ERSATZMESSER STRIPAX PL	9050340000	F.49
ESCH 1 M	0280300000	F.3
ESD 15 BOGEN DIN A4	1636510000	F.34
ESD 5 DIN A4 GELB BOG.	1631350000	F.31
ESD 5 DIN A4 WEISS BOG.	1607710000	F.31
ESD 5 POLY GELB A4-BOG.	1670380000	F.31
ESD 5 POLY WEISS A4-BOG.	1670370000	F.31
ESD 5 S DIN A4-BOGEN	1631920000	F.31
ESD 7 A4-BOGEN GELB	1634780000	F.31
ESD 7 A4-BOGEN WEISS	1607720000	F.31
ESD 7 POLY GELB A4-BOG.	1670400000	F.31
ESD 7 POLY WEISS A4-BOG.	1670390000	F.31
ETA 1170 21 10A	1278790000	C.63
ETA 1170 21 15A	1278810000	C.63
ETA 1170 21 20A	1278820000	C.63
ETA 1170 21 25A	1278830000	C.63
ETA 1170 21 3A	1278730000	C.63
ETA 1170 21 4A	1278740000	C.63
ETA 1170 21 5A	1278750000	C.63
ETA 1170 21 6A	1278760000	C.63
ETA 1170 21 7.5A	1278770000	C.63
ETA 1170 21 8A	1278780000	C.63
ETA 1180 01 0.1A	1278840000	C.64
ETA 1180 01 0.25A	1278860000	C.64
ETA 1180 01 0.2A	1278850000	C.64
ETA 1180 01 0.3A	1278870000	C.64
ETA 1180 01 0.4A	1278880000	C.64
ETA 1180 01 0.5A	1278910000	C.64
ETA 1180 01 0.6A	1278920000	C.64
ETA 1180 01 0.7A	1278930000	C.64
ETA 1180 01 0.8A	1278940000	C.64
ETA 1180 01 1.5A	1278960000	C.64
ETA 1180 01 10A	1279070000	C.64
ETA 1180 01 1A	1278950000	C.64
ETA 1180 01 2.5A	1278980000	C.64
ETA 1180 01 2A	1278970000	C.64
ETA 1180 01 3.5A	1279010000	C.64
ETA 1180 01 3A	1278990000	C.64
ETA 1180 01 4A	1279020000	C.64
ETA 1180 01 5A	1279030000	C.64
ETA 1180 01 6A	1279040000	C.64
ETA 1180 01 7A	1279050000	C.64
ETA 1180 01 8A	1279060000	C.64
EW 15	0382860000	F.12
EW 15/2	1071900000	F.12
EW 35	0383560000	F.12
EW 35 DB	1269050000	F.12
EW 35 GR 7032	0383530000	F.12
EW 35/SCHA/M3	0258660000	D.76
EWK 1	0206180000	F.12
EWK 2	0199360000	F.12

F

FEKO ET ZRV2.5 0.2-0.35	1893940000	C.95
FEKO ET ZRV2.5 0.5-1	1893970000	C.95
FEKO ET ZRV2.5 1.5-2.5	1893990000	C.95

Type	Order No.	Page
FEKO ZRV2.5 0.2-0.35	1854750000	C.95
FEKO ZRV2.5 0.5-1	1854760000	C.95
FEKO ZRV2.5 1.5-2.5	1848480000	C.95
FKSC M5X8 D9/SW2.5	0295900000	F.13
FKSC M6X12 D9/SW3	0353500000	F.13
FKSC M6X8 D9/SW3	0642600000	F.13
FM 4.2/TS35	1724580000	F.14
FM 4/TS35	0687900000	F.14
FM 5/TS35	0636800000	F.14
FM 6/TS35	0636900000	F.14
FUCR 100-36V SW	1167640000	D.112
FUCR 100-250V SW	1167680000	D.112
FUCR 30-70V SW	1167650000	D.112
FUCR 60-150V SW	1167670000	D.112
FUCR SW	1167630000	D.112
FUSE 1KV DC 10A 10/38	1224910000	D.47
FUSE 1KV DC 12A 10/38	1224920000	D.47
FUSE 1KV DC 16A 10/38	1224930000	D.47
FUSE 1KV DC 20A 10/38	1224950000	D.47
FUSE 1KV DC 2A 10/38	1224870000	D.47
FUSE 1KV DC 4A 10/38	1224880000	D.47
FUSE 1KV DC 6A 10/38	1224890000	D.47
FUSE 1KV DC 8A 10/38	1224900000	D.47

G

G 20/0.10A/F	0430300000	C.65
G 20/0.20A/F	0430400000	C.65
G 20/0.25A/F	0430500000	C.65
G 20/0.50A/F	0430600000	C.65
G 20/0.63A/F	0439000000	C.65
G 20/1.00A/F	0430700000	C.65
G 20/1.60A/F	0430800000	C.65
G 20/2.00A/F	0430900000	C.65
G 20/2.50A/F	0431000000	C.65
G 20/3.15A/F	0431100000	C.65
G 20/4.00A/F	0431200000	C.65
G 20/5.00A/F	0431300000	C.65
G 20/6.30A/F	0431400000	C.65
G 25/0.25A/M GE	0546900000	C.65
G 25/0.50A/M WS	0510300000	C.65
G 25/0.80A/M RT	0646400000	C.65
G 25/1.00A/M GR	0265800000	C.65
G 25/1.00A/M BL	0193100000	C.65
G 25/2.00A/F FL	0192700000	C.65
G 25/4.00A/F BR	0192800000	C.65
G 25/6.30A/F GN	0192900000	C.65
GHDZ PPS2.5/1AN	1866070000	C.99
GHWUE M3 WTL6	1255010000	D.69
GZ 0.5A/F	0533800000	C.65
GZ 1.0A/F	0525500000	C.65
GZ 10A/F	0293900000	C.65
GZ 12.5A/FF	0245400000	C.65
GZ 2.0A	0294500000	C.65
GZ 3.0A	0295700000	C.65
GZ 5.0A	0294600000	C.65
GZ 7.0A	0295800000	C.65

H

H 0,5/16 S OR	9202900000	F.76
H 10,0/22 S EB	9203620000	F.76
H 4,0/20 DS GR	9203630000	F.76
H 0,14/10 GR SV	9005180000	F.67
H 0,14/10T BR SV	9028250000	F.70
H 0,14/12 GR SV	9028240000	F.66
H 0,25/10 HBL	9025740000	F.66
H 0,25/10 HBL SV	9026050000	F.66
H 0,25/10T GE SV	9021010000	F.70
H 0,25/10T GE SV	9021210000	F.70
H 0,25/12 HBL SV	9025760000	F.66
H 0,25/12 HBL SV	9025780000	F.66
H 0,25/12T GE SV	9021020000	F.70
H 0,25/12T GE SV	9021220000	F.70
H 0,25/5	9018910000	F.77
H 0,34/10 TK	9025750000	F.66
H 0,34/10 TK SV	9026030000	F.66
H 0,34/11 S TK	9204090000	F.76
H 0,34/12 TK	9025770000	F.66
H 0,34/12 TK BD GSP	9004390000	F.67
H 0,34/12 TK SV	9025790	

Type	Order No.	Page
H1,5/14D SW BD	9004350000	F.68
H1,5/14D SW BD GSP	9005890000	F.69
H1,5/14D SW SV	9019430000	F.68
H1,5/14DS SW SV	9028360000	F.76
H1,5/14S R	9025980000	F.76
H1,5/14S R SV	9025720000	F.76
H1,5/14S SW	9025240000	F.76
H1,5/16 R	0635100000	F.66
H1,5/16 R SV	9028350000	F.66
H1,5/16 ZH R	9037290000	F.72
H1,5/16 ZH R SV	9004410000	F.72
H1,5/16D SW	9019130000	F.68
H1,5/16D ZH SW	9037470000	F.73
H1,5/16D ZH SW SV	9004420000	F.73
H1,5/17,5X SW SV	9006590000	F.75
H1,5/18	9004070000	F.77
H1,5/18D SW	9019140000	F.68
H1,5/19,5X SW SV	9006630000	F.75
H1,5/20 ZH R	9037300000	F.72
H1,5/20 ZH R SV	9004920000	F.72
H1,5/20D SW ZH SV	9004750000	F.73
H1,5/20D ZH SW	9037480000	F.73
H1,5/24 R	0565660000	F.66
H1,5/24 XS SW	9202870000	F.75
H1,5/24D SW	9019150000	F.68
H1,5/24D SW SV	9004140000	F.70
H1,5/26 ZH R	9037310000	F.72
H1,5/26D ZH SW	9037490000	F.73
H1,5/7	0372700000	F.77
H10,0/12	0282900000	F.77
H10,0/15	0124800000	F.77
H10,0/18	0379300000	F.77
H10,0/22 EB	0534200000	F.66
H10,0/22D R	9019240000	F.68
H10,0/22T BR	9021150000	F.70
H10,0/24 ZH EB	9037340000	F.72
H10,0/24 ZH EB SV	9004940000	F.72
H10,0/24,0X R SV	9006830000	F.75
H10,0/24D ZH R	9037570000	F.73
H10,0/24DS ZH R	9018880000	F.73
H10,0/24T ZH R	9037710000	F.74
H10,0/26D R ZH SV	9004710000	F.73
H10,0/26T ZH BR SV	9005170000	F.74
H10,0/28 EB	0565800000	F.66
H10,0/28D R	9019250000	F.68
H10,0/28T BR	9021160000	F.70
H10,0/30 ZH EB	9037350000	F.72
H10,0/30D ZH R	9037580000	F.73
H10,0/30T ZH BR	9037720000	F.74
H10/24S ZH EB	9018860000	F.72
H10/30DS ZH R	9018890000	F.73
H10/30S ZH EB	9018870000	F.72
H120,0/32	9036240000	F.77
H120,0/50 BL	9028220000	F.66
H150,0/32	9038250000	F.77
H150,0/54 GE	9028230000	F.66
H16,0/12	0492500000	F.77
H16,0/15	0124300000	F.77
H16,0/18	0375200000	F.77
H16,0/22 GN	0565900000	F.66
H16,0/22D BL	9019260000	F.68
H16,0/22T W	9021170000	F.70
H16,0/25	9004150000	F.77
H16,0/25,5X BL SV	9006870000	F.75
H16,0/28 GN	0566000000	F.66
H16,0/28D BL	9019270000	F.68
H16,0/28T W	9021180000	F.70
H16,0/29 ZH GN	9037360000	F.72
H16,0/29D ZH BL	9037590000	F.73
H16,0/29T ZH W	9037730000	F.74
H16,0/32	9004160000	F.77
H16,0/38 ZH GN	9037370000	F.72
H16,0/38D ZH BL	9037600000	F.73
H16,0/38T ZH W	9037740000	F.74
H185,0/32	9036260000	F.77
H2,5/10	9004080000	F.77
H2,5/12	0186100000	F.77
H2,5/12DS BL	9028490000	F.76
H2,5/12TS GR	9036200000	F.76
H2,5/14D BL BD	9004360000	F.67
H2,5/14D BL BD GSP	9005850000	F.67
H2,5/14S BL	1333100000	F.76
H2,5/14T GR BD	9004370000	F.70
H2,5/14T GR BD GSP	9005910000	F.71
H2,5/14TS GR	9426770000	F.76
H2,5/15 BL SV	9026100000	F.66
H2,5/15D BL	9019160000	F.66
H2,5/15T GR	9021070000	F.70
H2,5/15T GR SV	9021240000	F.70
H2,5/16DS BL	9036220000	F.76
H2,5/17,5X BL SV	9006670000	F.75
H2,5/18	9004090000	F.77
H2,5/19D BL	9019170000	F.66
H2,5/19D ZH BL	9037500000	F.72
H2,5/19D ZH BL SV	9004430000	F.72
H2,5/19T GR	9021080000	F.70
H2,5/19T ZH GR	9037640000	F.74
H2,5/19T ZH GR SV	9018580000	F.74
H2,5/21 ZH GR SV	9005150000	F.74

Type	Order No.	Page
H2,5/21,5X BL SV	9006710000	F.75
H2,5/21D ZH BL	9037510000	F.72
H2,5/21D ZH BL SV	9004740000	F.72
H2,5/21T ZH GR	9037650000	F.74
H2,5/24 XS BL	9202880000	F.75
H2,5/25D BL	9019180000	F.66
H2,5/25T GR	9021090000	F.70
H2,5/27D ZH BL	9037520000	F.72
H2,5/27T ZH GR	9037660000	F.74
H2,5/7	0373000000	F.77
H25,0/15	0124400000	F.77
H25,0/18	0375300000	F.77
H25,0/25	9004170000	F.77
H25,0/30 BR	9317000000	F.66
H25,0/30D 16 GE	9019280000	F.68
H25,0/30T SW	9021190000	F.70
H25,0/32	9004180000	F.77
H25,0/36 BR	0317100000	F.66
H25,0/36D GE	9019300000	F.68
H25,0/36T SW	9021200000	F.70
H35,0/18	0368900000	F.77
H35,0/25	9004190000	F.77
H35,0/30 BE	0317200000	F.66
H35,0/30D 16 R	9019310000	F.68
H35,0/30S	9451000000	F.77
H35,0/32	9004200000	F.77
H35,0/32D R	9019320000	F.68
H35,0/39 BE	0317300000	F.66
H35,0/39D R	9019330000	F.68
H4,0/12	0244100000	F.77
H4,0/15	9004100000	F.77
H4,0/18	9004110000	F.77
H4,0/18 GR SV	9026010000	F.66
H4,0/18D GR	9019190000	F.66
H4,0/18T OR	9021100000	F.70
H4,0/18T OR SV	9021250000	F.70
H4,0/19,5X GR SV	9006750000	F.75
H4,0/20D GR	9019200000	F.66
H4,0/20T OR	9021110000	F.70
H4,0/22D ZH GR	9037530000	F.72
H4,0/22T ZH OR	9037670000	F.74
H4,0/22T ZH OR SV	9018590000	F.74
H4,0/26D GR	9019210000	F.66
H4,0/26T OR	9021120000	F.70
H4,0/28D ZH GR	9037540000	F.72
H4,0/28T ZH OR	9037680000	F.74
H4,0/9	0373100000	F.77
H4/22D ZH GR SV	9004730000	F.72
H50,0/18	9004210000	F.77
H50,0/22	9025880000	F.77
H50,0/32	9004220000	F.77
H50,0/41D BL	9019350000	F.68
H50/36 OLIV	0444200000	F.66
H50/36D BL	9019340000	F.68
H6,0/0/20T GN	9021130000	F.70
H6,0/10	9004120000	F.77
H6,0/12	0191900000	F.77
H6,0/15	0124700000	F.77
H6,0/18	9004130000	F.77
H6,0/20 SW	0533500000	F.66
H6,0/20D GE	9019220000	F.68
H6,0/23 ZH SW	9037320000	F.72
H6,0/23 ZH SW SV	9004930000	F.72
H6,0/23,0X GE SV	9006790000	F.75
H6,0/23D ZH GE	9037550000	F.73
H6,0/23D ZH GE SV	9004720000	F.73
H6,0/23T ZH GN	9037690000	F.74
H6,0/23T ZH GN SV	9005160000	F.74
H6,0/26 SW	0565700000	F.66
H6,0/26D GE	9019230000	F.68
H6,0/29 ZH SW	9037330000	F.72
H6,0/29D ZH GE	9037560000	F.73
H6,0/29T ZH GN	9037700000	F.74
H6/26T GN	9021140000	F.70
H70,0/25	9004230000	F.77
H70,0/32	9004240000	F.77
H70,0/37 GE	9028200000	F.66
H95,0/25	9004250000	F.77
H95,0/32	9004260000	F.77
H95,0/44 R	9028210000	F.66
HA ADP WF6/WF10	1781050000	D.147
HBT 1,5 - 3,0 RT	1312440000	D.86
HBT 1,5 - 4,6 RT	1233340000	D.86
HBT 2,5 - 3,0 BL	1312450000	D.86
HBT 2,5 - 4,6 BL	1233330000	D.86
HBT 6,0 - 4,6 GE	1216230000	D.86
HOOKBLA 0,25-1,5 SW	9036290000	F.78
HOOKBLA 1,0-2,5 SW	9036300000	F.78
HP 1 ADP1	0485560000	F.15
HP 2 ADP2	0485660000	F.15
HP 3 ADP3	0485760000	F.15
HP 4 ADP3	0485860000	F.15
HP 7 TSK31.5	0258260000	F.15
HP 8 ADP 1	0258360000	F.15
HTF AFK 2.5	9201040000	C.95
HTF ZRV	9014840000	C.94
HTI 15	9014400000	F.65

Type	Order No.	Page
I		
IEPL	1859570000	C.134
IK 16 /ZB16 BL	0502980000	F.6
IK 16 /ZB16 GG	0502960000	F.6
IK 35 /ZB35 BL	0502780000	F.6
IK 4 BL ZB4	0475480000	F.6
IK 4 GG ZB4	0475460000	F.6
IK 6 GG ZBE6K	0526060000	F.6
IL WMF2,5 BLZ OR	1167440000	D.112
IS 2 KG	1806630000	F.63
IS 3 KG	1806650000	F.63
IS 4 DIN 6911	0485100000	F.63
IS 4 KG	1806660000	F.63
IS 6 DIN 6911	0407900000	F.63
IS 8 DIN 6911	0235000000	F.63
ISPF QB58 SW	0546000000	D.63
K		
KDKS 1/35 DB	9532440000	D.34
KISC M3X20 5/10 EK4	0303000000	D.76
KISC M3X5	1052100000	D.172
KLBUE 10-20	1600490000	E.6
KLBUE 10-20 CPF	1752701001	E.13
KLBUE 10-20 CPF16	1252550000	E.13
KLBUE 10-20 FM4	1252510000	E.12
KLBUE 10-20 SC	1712321001	E.11
KLBUE 15-32	1716300000	E.6
KLBUE 15-32 CPF	1752711001	E.13
KLBUE 15-32 CPF16	1252540000	E.13
KLBUE 15-32 FM4	1252490000	E.12
KLBUE 15-32 SC	1718341001	E.11
KLBUE 2X2,6	1675350000	E.6
KLBUE 3-8	1600480000	E.6
KLBUE 3-8 CPF	1752681001	E.13
KLBUE 3-8 FM4	1252530000	E.12
KLBUE 3-8 SC	1692261001	E.11
KLBUE 3-8 SDSC	1835840000	E.11
KLBUE 4-13,5	1592810000	E.6
KLBUE 4-13,5 CPF	1752691001	E.13
KLBUE 4-13,5 CPF16	1167850000	E.13
KLBUE 4-13,5 FM4	1252520000	E.12
KLBUE 4-13,5 SC	1712311001	E.11
KLBUE 4-6 Z/1	2269800000	E.14
KLBUE CO 1	1753311001	E.7
KLBUE CO 2	1752131001	E.7
KLBUE CO 3	1749151001	E.7
KLBUE CO 4	1749161001	E.7
KLBUE CO 5	1755081001	E.7
KLBUE SH1	0635960000	F.4
KOSF ZT2,5	1016150000	C.100
KOSF ZT4	1856960000	D.102
KS 10 0.D10	0141620000	D.136
KS 2 0.D2	0134420000	D.136
KS 4 0.D4	0140320000	D.136
KS 6 0.D6	0140620000	D.136
KSBR/2 ZTL6	1771820000	C.68
KSBR/3 ZTL6	1771830000	C.69
KSBR/4 ZTL6	1771840000	C.69
KT 12	9002660000	F.42
KT 22	1157830000	F.42
KT 45 R	9202040000	F.46
KT 55 R	9202060000	F.46
KT 8	9002650000	F.42
KT ZDV	9002170000	F.44
L		
LADEGERAET DMS 3	9007460000	F.64
LD 1,5B25 VF	9200490000	F.79
LD 2,5B25 VF	9200500000	F.79
LD 6B26 VF	9200510000	F.79
LD 1,5F4 RF	9200700000	F.80
LD 1,5M4 R	9200670000	F.80
LD 2,5F5 RF	9200710000	F.80
LD 2,5M5 R	9200680000	F.80
LD 6,0F5 RF	9200720000	F.80
LD 6M5 R	9200690000	F.80
UF 1,5F288 R	9200520000	F.79
UF 1,5F488 R	9200530000	F.79
UF 1,5F638 R	9200540000	F.79
UF 1,5F638 RF	9200640000	F.79
UF 1,5M638 R	9200580000	F.79
UF 1,5F638 R	9200610000	F.79
UF 2,5F488 R	9200550000	F.79
UF 2,5F638 R	9200560000	F.79
UF 2,5F638 RF	9200650000	F.79
UF 2,5M638 R	9200590000	F.79
UF 2,5F638 R	9200620000	F.79
UF 6F638 R	9200570000	F.79
UF 6F638 RF	9200660000	F.79
UF 6M638 R	9200600000	F.79
UF 6T638 R	9200630000	F.79
UF 1,5R12 V	9200460000	F.78
UP 2,5R12 V	9200470000	F.78
UP 6R14 V	9200480000	F.78
UR 1,5M3 V	9200070000	F.78
UR 1,5M3,5 V	9200080000	F.78

Type	Order No.	Page
LR 1,5M4 V	9200090000	F.78
LR 1,5M5 V	9200100000	F.78
LR 1,		

Type	Order No.	Page
P 14/4 D01 BR SAKS4	0138100000	D.48
P 14/6 D01 GN SAKS4	0328600000	D.53
P 16/10 RT SAKS2	0208900000	D.48
P 16/16 GR SAKS2	0209000000	D.48
P 16/20 BL SAKS2	0209100000	D.48
P 18/20 D02 BL SAKS5	0361800000	D.49
P 18/25 D02 GE SAKS5	0361900000	D.49
P 18/35 D02 SW SAKS5	0362000000	D.49
P 18/50 D02 WS SAKS5	0362100000	D.49
P-CLEANER	1924330000	F.39
P-Ink 2.0	1924340000	F.39
PAD 16/4	1916170000	B.7
PAD 2.5/4/4	1916150000	B.4
PAD 6/10/4	1916160000	B.5
PAP 16	1896290000	B.7
PAP 2.5/4	1896300000	B.4
PAP 2.5/4 BL	1049210000	B.46
PAP 2.5/4/3AN	1896480000	B.11
PAP 2.5/4/3AN BL	1052300000	B.46
PAP 2.5/4/4AN	1896320000	B.4
PAP 2.5/4/4AN BL	1052320000	B.46
PAP PDL 2.5/4	1919720000	B.8
PAP PDL4	1883210000	B.21
PAP PDL4S	1837070000	B.30
PAP PDU16S	1139910000	B.26
PAP PDU6/10	1896330000	B.5
PAP PDU6/10 BL	1049200000	B.46
PAP PDU6/10/3AN	1896340000	B.6
PAP PMAK 4	1221360000	B.10
PAP PRV/PPV4 BL	1268010000	B.38
PAP PRV/PPV4 GR	1211450000	B.38
PAP PRV/PPV4 SW	1173750000	B.38
PAP PRV/PPV8 BL	1268080000	B.39
PAP PRV/PPV8 GR	1211460000	B.39
PAP PRV/PPV8 SW	1173720000	B.39
PAP PTL/PSI 6/10	1165320000	B.46
PAP PTL/PSI 6/10 SW	1165330000	B.46
PAP PTR2.5/4	1934680000	B.18
PAP PTR2.5/4/3AN	1934690000	B.19
PAP PTR2.5/4/4AN	1934700000	B.19
PK 2.5/4	1918770000	B.8
PK 2.5/4 BL	1918760000	B.8
PK 2.5/4 PE	1918710000	B.15
PK 2.5/4LPE	1918720000	B.9
PK 2.5/4NL	1918740000	B.9
PK 2.5/4V	1918730000	B.8
PK 2.5/4V BL	1918680000	B.8
PDL 4 S/L	1847610000	B.31
PDL 4 S/L/L	1837030000	B.30
PDL 4 S/L/L/PE	1837040000	B.32
PDL 4 S/N	1847620000	B.32
PDL 4 S/N/L	1847630000	B.31
PDL 4 S/N/L/PE	1837050000	B.31
PDL 4 S/NT/L/PE	1837060000	B.30
PDL 4/L/L	1882590000	B.35
PDL 4/L/L/PE	1882610000	B.34
PDL 4/N/L/PE	1889180000	B.34
PDL 4/NT/L	1882600000	B.33
PDL 4/NT/L/PE	1882620000	B.33
PDL 4/TR/DU	1899190000	B.22
PDL 4/TR/DU 0 TNHE	1899210000	B.21
PDL 4/TR/DU/PE	1899200000	B.22
PDL 4/TR/DU/PE 0 TNHE	1899220000	B.21
PDU 16	1896400000	B.7
PDU 16 BL	1896220000	B.7
PDU 16S	1139580000	B.26
PDU 2.5/4	1896110000	B.4
PDU 2.5/4 BL	1896230000	B.4
PDU 2.5/4/2X2AN	1022220000	B.5
PDU 2.5/4/3AN	1896120000	B.4
PDU 2.5/4/3AN BL	1896240000	B.4
PDU 2.5/4/4AN	1896130000	B.5
PDU 2.5/4/4AN BL	1896250000	B.5
PDU 6/10	1896140000	B.5
PDU 6/10 4AN BL	1165130000	B.6
PDU 6/10 BL	1896270000	B.5
PDU 6/10/3AN	1896150000	B.6
PDU 6/10/3AN BL	1896280000	B.6
PDU 6/10/4AN	1083040000	B.6
PEI 16	1918780000	B.7
PEI 16 BL	1918790000	B.7
PHP PDL	1837090000	B.30
PHP PDL SO	1837080000	B.30
PHP PNT 2.5/4	1896390000	B.28
PHP PNT 2.5/4 SO	1916790000	B.28
PHP PNT 6/10	1896100000	B.28
PHP PNT 6/10 SO	1919710000	B.28
PHP PNT16	1896380000	B.29
PHP PNT16 SO	1919690000	B.29
PJ PRO TINTENSET FARBE	1027110000	F.36
PJ PRO TNAW	1024140000	F.36
PJ PRO TINTK INK C	1027050000	F.36
PJ PRO TINTK INK K	1027040000	F.36
PJ PRO TINTK INK M	1027060000	F.36
PJ PRO TINTK INK Y	1027070000	F.36
PJ-Clean Unit	4062150000	F.36
PLOTTER PEN 0.25 P-INK	1920640000	F.39
PLOTTER PEN 0.35 P-INK	1920650000	F.39
PLOTTER PEN 0.50 P-INK	1005710000	F.39

Type	Order No.	Page
PLOTTER PEN 0.70 P-INK	1011450000	F.39
Plotterpen 0.18	1768570000	F.39
Plotterpen 0.25	1768540000	F.39
Plotterpen 0.35	1768550000	F.39
Plotterpen 0.5	1768560000	F.39
PLOTTERPEN 0,7	1011440000	F.39
PMAK 4	1221340000	B.10
PMAK 4 800V	1221350000	B.10
PNT 16	1896350000	B.29
PNT 2.5/4	1896360000	B.28
PNT 6/10	1896370000	B.28
PPE 16	1896210000	B.14
PPE 16S	1139570000	B.27
PPE 2.5/4	1896170000	B.11
PPE 2.5/4/3AN	1896200000	B.11
PPE 2.5/4/4AN	1896160000	B.12
PPE 6/10	1896180000	B.12
PPE 6/10/3AN	1896190000	B.13
PPV 4 BL 35X15 DGR	1267910000	B.41
PPV 4 BL 35X7.5 DGR	1267920000	B.41
PPV 4 GR 35X15 DGR	1173880000	B.41
PPV 4 GR 35X7.5 DGR	1173890000	B.41
PPV 8 BL 35X15 DGR	1267870000	B.41
PPV 8 BL 35X7.5 DGR	1267880000	B.41
PPV 8 GR 35X15 DGR	1173850000	B.41
PPV 8 GR 35X7.5 DGR	1173870000	B.41
PRH 2.5/4/1	1916410000	B.4
PRH 2.5/4/2	1916400000	B.4
PRINT KIT	1686920000	F.40
PRINTJET PRO 115V	1024050000	F.36
PRINTJET PRO 230V	101180001	F.36
PRV 16 BL 35X15 RT/WS	1267790000	B.40
PRV 16 BL 35X15 WS/RT	1267800000	B.40
PRV 16 BL 35X7.5 RT/WS	1267810000	B.40
PRV 16 BL 35X7.5 WS/RT	1267820000	B.40
PRV 16 SW 35X15 RT/WS	1173620000	B.40
PRV 16 SW 35X15 WS/RT	1173650000	B.40
PRV 16 SW 35X7.5 RT/WS	1173680000	B.40
PRV 16 SW 35X7.5 WS/RT	1173710000	B.40
PRV 4 BL 35X15 RT	1267890000	B.38
PRV 4 BL 35X15 WS	1173920000	B.38
PRV 4 BL 35X7.5 RT	1267900000	B.38
PRV 4 BL 35X7.5 WS	1173930000	B.38
PRV 4 SW 35X15 RT	1173810000	B.38
PRV 4 SW 35X15 WS	1173820000	B.38
PRV 4 SW 35X7.5 RT	1173830000	B.38
PRV 4 SW 35X7.5 WS	1173840000	B.38
PRV 8 BL 35X15 RT/WS	1267830000	B.39
PRV 8 BL 35X15 WS/RT	1173900000	B.39
PRV 8 BL 35X7.5 RT/WS	1267840000	B.39
PRV 8 BL 35X7.5 WS/RT	1173910000	B.39
PRV 8 SW 35X15 RT/WS	1173740000	B.39
PRV 8 SW 35X15 WS/RT	1173780000	B.39
PRV 8 SW 35X7.5 RT/WS	1173790000	B.39
PRV 8 SW 35X7.5 WS/RT	1173800000	B.39
PS 2.0 DR	0293800000	C.143
PS 2.3 RT	0184040000	D.173
PS 4 FTB 4	0299600000	C.69
PS_ZOV	1121740000	C.144
PS_ZOV_SET	1116710000	C.144
PSI 6/10	1083050000	B.16
PSI 6/10 SW	1165140000	B.16
PTA PDU2.5/4	1916180000	B.4
PTA ZA PDU2.5/4	1916190000	B.4
PTD 6/10/STB	1084790000	B.23
PTL 6/10/STB	1084780000	B.23
PTR 2.5/4	1933950000	B.18
PTR 2.5/4 BL	1933970000	B.18
PTR 2.5/4 0 TNHE	1933910000	B.18
PTR 2.5/4/3AN	1933980000	B.19
PTR 2.5/4/3AN BL	1933930000	B.19
PTR 2.5/4/3AN 0 TNHE	1933990000	B.19
PTR 2.5/4/4AN	1933940000	B.19
PTR 2.5/4/4AN BL	1934000000	B.19
PTR 2.5/4/4AN 0 TNHE	1933980000	B.20
PZ 1.5	9005990000	F.65
PZ 16	9012600000	F.52
PZ 3	0567300000	F.51
PZ 4	9012500000	F.50
PZ 50	9006450000	F.53
PZ 6 HEX	9013650000	F.65
PZ 6 Roto	9014350000	F.51
PZ 6/5	9011460000	F.50
PZ ZH 16	9013600000	F.52

Q

Q 10 AKZ1.5	0368500000	D.130
Q 10 AKZ4	0368600000	D.131
Q 10 AKZ4SS	0369300000	D.17
Q 10 DLJ	1313100000	D.170
Q 10 WDL2.5S	1071800000	D.170
Q 10 WTL 6/4FF	1897190000	D.76
Q 2 AKZ1.5	0368200000	D.130
Q 2 AKZ4	0336400000	D.131
Q 2 AKZ4SS	0369000000	D.17
Q 2 DLJ	1312500000	D.170
Q 2 WDL2.5S	1071500000	D.170
Q 2 WTL6/2FF	1897110000	D.76

Type	Order No.	Page
Q 20 DLJ	1399800000	D.170
Q 20 WDL2.5S	1074200000	D.170
Q 3 AKZ1.5	0368300000	D.130
Q 3 AKZ2.5	0336500000	D.131
Q 3 DLJ	1312600000	D.170
Q 3 WDL2.5S	1071600000	D.170
Q 3 WTL6/2FF	1897120000	D.76
Q 4 AKZ1.5	0368400000	D.130
Q 4 AKZ4	0336600000	D.131
Q 4 DLJ	1312700000	D.170
Q 4 WDL2.5S	1071700000	D.170
Q 4 WTL 6/4FF	1897130000	D.76
Q WDU10-2.5 SET	1859620000	D.161
Q WDU6 2.5 SET	1859600000	D.162
QB 58/8/9/WI	0545300000	D.63
QL 2 AKZ4	0471000000	D.43
QL 10 SAKGN	0338300000	D.172
QL 10 SAKS2	0338900000	D.48
QL 10 SAKS4	0339000000	D.48
QL 10 WTL 6/4 FF	1897090000	D.76
QL 15 SAKGN	0221200000	D.71
QL 2 SAK16	0470700000	D.43
QL 2 SAKGN	0194300000	D.172
QL 2 SAKS2	0207800000	D.48
QL 2 SAKS4	0328000000	D.48
QL 2 WTL6/4FF	1897010000	D.76
QL 3 SAK16	0470800000	D.43
QL 3 SAKGN	0194400000	D.172
QL 3 SAKS4	0328100000	D.48
QL 3 WTL6/4FF	1897020000	D.76
QL 4 SAK16	0470900000	D.43
QL 4 SAKGN	0194500000	D.172
QL 4 SAKS2	0208000000	D.48
QL 4 WTL6/4FF	1897030000	D.76
QL 50 WTL6/4FF	1897100000	D.76
QS 2/10/4	0270860000	D.71
QS 2/12/4	0270760000	D.71
QS 2/8/4	0270960000	B.23
QVAR 1	1836370000	C.134
QVS 2 SAKT1+2	0307300000	D.65
QVS 2/4 SAKT4	1319260000	D.72
QVS 2/S SAKT1+2	0358460000	D.70
QVS 3 SAKT1+2	0329300000	D.70
QVS 4 SAKT1+2	0307400000	D.70
QVSK 2 SAKT1	1670360000	D.70

R

Reiniger 2000 25ml	1772130000	F.39
Removal Tool AFK	1866760000	C.95

S

SAKS 2/35 DB	1368700000	D.48
SAKS 4/35 DB	0501800000	D.48
SAKS 5/35 DB	0502100000	D.49
SCH-1WB	1739890000	E.11
SCHT 14/6	1269060000	F.32
SCHT 5	0292460000	F.31
SCHT 5 S	1631930000	F.31
SCHT 7	0517960000	F.31
SCHT 9/4	1278460000	F.32
SD 0.4x2,0x60	9037160000	F.57
SD 0.4x2,5x75	9009030000	F.57
SD 0.5x3,0x80	9008320000	F.57
SD 0.6x3,5x100	9008330000	F.57
SD 0.6x3,5x200	9010110000	F.57
SD 0.8x4,0x100	9008340000	F.57
SD 0.8x4,5x125	9009020000	F.57
SD 1.0x5,5x150	9008350000	F.57
SD 1.2x6,5x100	9009010000	F.57
SD TH20	9009160000	F.57
SDI 0.4x2,5x75	9008370000	B.30
SDI 0.6x3,5x100	9008390000	D.96
SDI 0.8x4,0x100	9008400000	D.76
SDI SL 0.6X3,5X100	1274660000	F.56
SDI SL 0.8X4,0X100	1274670000	F.56
SDI SL 1.0X5,5X125	1274680000	F.56
SDI SL 1.2X6,5X150	1274690000	F.56
SDIK SL PH1	1274710000	F.56
SDIK SL PH2	1274720000	F.56
SDIK SL PZ1	1274730000	F.56
SDIK SL PZ2	1274740000	F.56
SDIS 2.5-5.5/PH1/2	9009730000	F.55
SDIS 2.0-5.5	9205550000	F.55
SDIS 2.5-5.5/PZ1/2	1128540000	F.55
SDIS SL 3.5-6.5/PH1/2	1274750000	F.56
SDIZ 0.8X5,5 150/248	9008640000	D.76
SDK P20	9008520000	F.57
SDK P21	9008530000	F.57
SDK P22	9008540000	F.57
SDK P23	9008550000	F.57
SH 1	0299860000	F.4
SH 2	0494920000	F.4
SH 2 S	0641720000	F.4

Type	Order No.	Page
STB 36.8/IH/BL WTL6/1	1847790000	D.73
STB 36.8/IH/DB WTL6/1	1847740000	B.23
STB 36.8/IH/GE WTL6/1	1847760000	D.73
STB 36.8/IH/GN WTL6/1	1847770000	D.73
STB 36.8/IH/VI WTL6/1	1847780000	D.71
STB 8.5/5/2.3/M3 SAK2.5	0280600000	D.72
STB 8.5/D4/2.3/M2.5 AKZ	0215700000	D.173
STGH 4 ZRV1.5	1698190000	C.94
STGH 4 ZRV1.5/PE GN	1698200000	C.94
STGH O.R./SW ZRV2.5	1898420000	C.95
STGH O.ZA ZRV2.5	1907010000	C.95
STGH O.ZA/O.R./SW ZRV2.5	1898430000	C.95
STGH ZPC2.5 DB	2321640000	C.84
STGH ZRV2.5	1907000000	C.95
STI Waterproof schwarz	0508401694	F.39
STR 15 F. ZGB 15	1636520000	F.34
STR 5 F.SCHT 5	0294000000	F.31
STR 5 S F.SCHT 5 S	1631940000	F.31
STR 7 F.SCHT 7	0515300000	F.31
STRIPAX	9005000000	F.48
STRIPAX 16	9005610000	F.48
STRIPAX PLUS 2.5	9020000000	F.49
SWIFTY	9006020000	F.54
SWIFTY SET	9006060000	F.54

T

TH-S 9-40	9008880000	F.58
Tinte 2000 25ml	1722120000	F.39
Tintenpatrone PrintJet	1797460000	F.36
Tintentank PrintJet II	1858920000	F.36
TNST	1833090000	D.178
TS 15x5 2M/AL/BK	0134700000	F.9
TS 15x5 2M/ST/ZN	0514200000	F.9
TS 15x5/LL 1M/ST/ZN	0117510000	F.9
TS 15x5/LL 2M/ST/ZN	0117500000	F.9
TS 27x12.5M/ST/FZN	1802690000	E.13
TS 32x15 2M/AL/BK	0169300000	F.9
TS 32x15 2M/CRN	0293220000	F.9
TS 32x15 2M/ST/ZN	0122800000	F.9
TS 32x15/LL 2M/ST/ZN	0514400000	F.9
TS 35x15 2M/ST/ZN	0236400000	F.10
TS 35x15/2.3 2M/AL/BK	1848290000	F.10
TS 35x15/2.3 2M/CU/BK	0270100000	F.10
TS 35x15/2.3 2M/ST/ZN	0498000000	F.10
TS 35x15/6X18 2M/ST/ZN	1805980000	F.10
TS 35x15/6X25 2M/ST/ZN	1866290000	F.10
TS 35x15/LL 1M/ST/ZN	0236510000	F.10
TS 35x15/LL 2M/ST/ZN	0236500000	F.10
TS 35x7.5 1M/ST/ZN	0383410000	F.10
TS 35x7.5 2M/AL/BK	0303800000	F.10
TS 35x7.5 2M/CRN	1747350000	F.10
TS 35x7.5 2M/ST/ZN	0383400000	F.10
TS 35x7.5/LL 1M/ST/ZN	0514510000	F.10
TS 35x7.5/LL 2M/ST/ZN	0514500000	F.10
TS 35x7.5/LL 6/2M/ST/ZN	0514570000	F.10
TS END CAP 35X15	1283480000	F.11
TS END CAP 35X7.5	1283470000	F.11
TSCH 1	0319160000	D.92
TSCH 2	0353660000	D.65
TSK 31.5 GR	0347960000	F.15
TSK 35x15 2M PVC/GR	0514300000	F.11
TSLD 5	1891700000	F.45
TSLD C	1270310000	F.45
TST 2/M5	1286600000	F.13
TST 2/M6	0101700000	F.13
TSTW 5/M5	0178100000	F.13
TSTW 5/M6 ZN	1779100000	F.13
TSTW 6/M6	0164000000	F.13
TW AKZ2.5	0318560000	D.130
TW AKZA	0348260000	D.131
TW PRV16	1173630000	B.40
TW PRV16 0-15	1230130000	B.40
TW PRV16 1-16	1230120000	B.40
TW PRV16 A-P	1230140000	B.40
TW PRV4	1173700000	B.38
TW PRV4 0-3	1230060000	B.38
TW PRV4 1-4	1230050000	B.38
TW PRV4 A-D	1230070000	B.38
TW PRV8	1173670000	B.39
TW PRV8 0-7	1230090000	B.39
TW PRV8 1-8	1230080000	B.39
TW PRV8 A-H	1230110000	B.39

V

VH 12/4.9/3.3 SAK6N	0249000000	D.71
VH 13.5/4.9/3.3 SAK4	0248500000	D.76
VH 16/5/3.5 SAK10-35	0309700000	D.63
VH 19/6/4.2 SAKT1	0318000000	D.65
VKSW	1137530000	F.45
VLI 1.5 DB	1784120000	D.96
VLI 1.5/PE DB	1784130000	D.96
VQB 1.5/50 BL	1633280000	D.96
VQB 1.5/50 RT	1633290000	D.96
VQB 1.5/50 SW	1635120000	D.96

W

Type	Order No.	Page
WAD 12 M. BL	1055960000	F.33
WAD 12 NEUTRAL	1056260000	F.33
WAD 12N GE BED	1073200000	D.9
WAD 16N GE BED	1083600000	D.11
WAD 16N WS	1083500000	D.176
WAD 20 GE WSD	9512260000	D.176
WAD 27 M. BL	1062860000	F.33
WAD 27 NEUTRAL	1062960000	F.33
WAD 4 GE BED	1072000000	D.176
WAD 4 WS	1072100000	D.176
WAD 5 MC B GE/SW	1120450000	F.33
WAD 5 MC NE GE	1112920000	F.33
WAD 5 MC NE WS	1112910000	F.33
WAD 5 MC SDR	1112930000	F.33
WAD 8 MC B GE/SW	1120470000	F.33
WAD 8 MC NE GE	1112950000	F.33
WAD 8 MC NE WS	1112940000	F.33
WAD 8 MC SDR	1112970000	F.33
WAD WDU1.5/BLZ/BLA	1074000000	D.100
WAD WMF2.5	1142970000	D.112
WAH 120	1064660000	D.149
WAH 185/300 BE	1064760000	D.149
WAH 35	1064460000	D.148
WAH 70 BE	1064560000	D.148
WAP 16+35 WTW 2.5-10	1050100000	D.157
WAP 16+35 WTW 2.5-10 BL	1050180000	D.157
WAP 16+35 WTW 2.5-10 OR	1050160000	D.157
WAP 2.5-10	1050000000	D.156
WAP 2.5-10 BL	1050080000	D.156
WAP 2.5-10 BR	1050070000	D.156
WAP 2.5-10 GE	1050020000	D.156
WAP 2.5-10 GN	1072200000	D.156
WAP 2.5-10 GR	1050050000	D.156
WAP 2.5-10 OR	1050060000	D.156
WAP 2.5-10 RT	1050040000	D.156
WAP 2.5-10 SW	1050010000	D.156
WAP 2.5-10 VI	1072210000	D.156
WAP 2.5-10 WS	1050090000	D.156
WAP 2.5-10/0.5mm	1966380000	D.156
WAP WDK 2.5N/TR-DU	1839850000	D.60
WAP WDK1.5/R3.5	1754200000	D.132
WAP WDK10	1186720000	D.21
WAP WDK10 BL	1186730000	D.21
WAP WDK2.5	1059100000	D.157
WAP WDK2.5 BL	1059180000	D.157
WAP WDK2.5 GN	1059140000	D.157
WAP WDK2.5/4 N	1084000000	D.158
WAP WDK2.5/4 N BL	1084080000	D.158
WAP WDK2.5/BLZ/M.ZA	1070100000	D.101
WAP WDK2.5/BLZ/O.ZA	1070000000	D.101
WAP WDK2.5/BLZ/O.ZA LG	1112130000	D.157
WAP WDL2.5	1067800000	D.157
WAP WDL2.5/S	1067700000	D.157
WAP WDU/WTR4/ZR	1905070000	D.157
WAP WDU/WTR4/ZZ	1905150000	D.157
WAP WDU1.5/BLZ	1577330000	D.100
WAP WDU1.5/BLZ/ZA	1577320000	D.100
WAP WDU1.5/R3.5	1754190000	D.133
WAP WDU2.5N/4N	1060000000	D.158
WAP WDU2.5N/4N BL	1060080000	D.158
WAP WDU2.5N/4N GE	1060090000	D.158
WAP WDU2.5N/4N OR	1060060000	D.158
WAP WFF120	1073000000	D.158
WAP WFF35	1069700000	D.158
WAP WFF70	1069800000	D.158
WAP WS14/2	1880450000	D.32
WAP WTA/4AN/2	1107780000	D.102
WAP WTL4/2	1881640000	D.72
WAP WTL6 SL	9538110000	D.158
WAP WTL6 SL 4-6	1238880000	D.90
WAP WTL6/1	1068300000	D.65
WAP WTL6/1 EN	1957710000	D.74
WAP WTL6/3	1879910000	D.158
WAP WTL6/4FF	1887240000	D.76
WAP WTR2.5/ZZ	1074600000	D.55
WAP WTR2.5/ZZ BL	1074680000	D.157
WAW 1 NEUTRAL	9004500000	F.43
WAW 2	9004510000	D.172
WBB WDK2.5/BL5.08	1072660000	D.101
WBB WDU1.5/BL...	1068160000	D.100
WBB WMF2.5 BLZ	1142980000	D.112
WBB ZA WDK2.5/BL5.08	1072760000	D.101
WBB ZA WDU1.5/BL 10/10	1068260000	D.100
WD 1 25 K KARTE A 6 ST	1563900000	D.151
WDK 1.5/R3.5	1753290000	D.132
WDK 10	1186740000	D.21
WDK 10 BL	1186750000	D.21
WDK 10 V	1186770000	D.21
WDK 10 V BL	1186780000	D.21
WDK 2.5	1021500000	D.16
WDK 2.5 1D	8025610000	D.117
WDK 2.5 1D A.1	1023400000	D.117
WDK 2.5 1D A.2	1023300000	D.118
WDK 2.5 2D	1023500000	D.119
WDK 2.5 2D 1.A	8014670000	D.118
WDK 2.5 2D 2.A	1022600000	D.119
WDK 2.5 BL	1021580000	D.16

Type	Order No.	Page
WDK 2.5 F	1021600000	D.99
WDK 2.5 F BL	1021680000	D.99
WDK 2.5 FF	1021700000	D.99
WDK 2.5 FV	1022400000	D.99
WDK 2.5 LD GR 1R 24VDC	8010040000	D.120
WDK 2.5 LD RT 24VDC	8023630000	D.120
WDK 2.5 LD RT 24VDC +-	1023600000	D.120
WDK 2.5 LD/GN 1R 24VDC	8023610000	D.120
WDK 2.5 OR	1021560000	D.181
WDK 2.5 ZOV	1041100000	D.16
WDK 2.5 ZOV BL	1041180000	D.16
WDK 2.5/10	1025700000	D.182
WDK 2.5/BLZ/5.08/ZA	1034400000	D.101
WDK 2.5/BLZ/5.08/ZA V	1027410000	D.101
WDK 2.5/D	1023200000	D.119
WDK 2.5/EX	1029100000	D.17
WDK 2.5/TR-DU	1247290000	D.60
WDK 2.5/TR-DU STB	1247310000	D.60
WDK 2.5/TR-DU-PE	1247420000	D.61
WDK 2.5/TR-DU-PE STB	1247430000	D.61
WDK 2.5/TR-DU-PE/o TNHE	1833640000	D.61
WDK 2.5/TR-DU-PE/o TNHE SIB	1833670000	D.61
WDK 2.5/TR-DU/o TNHE	1833600000	D.60
WDK 2.5/TR-DU/o TNHE STB	1833610000	D.60
WDK 2.5DU-PE	1036400000	D.17
WDK 2.5N	1041600000	D.18
WDK 2.5N BL	1041680000	D.18
WDK 2.5N DU-PE	1041650000	D.19
WDK 2.5N PE	1041620000	D.24
WDK 2.5N V	1041610000	D.18
WDK 2.5PE	1036300000	D.23
WDK 2.5V	1022300000	D.17
WDK 2.5V BL	1022380000	D.17
WDK 2.5V GE	1022350000	D.181
WDK 2.5V OR	1022360000	D.181
WDK 4N	1041900000	D.19
WDK 4N BL	1041980000	D.19
WDK 4N DU-PE	1041950000	D.20
WDK 4N OR	1041960000	D.181
WDK 4N PE	1041920000	D.26
WDK 4N V	1041910000	D.19
WDL 2.5/2/S/NT/L/PEL/L	1034100000	D.182
WDL 2.5/3/S/NT/L/PE	1034200000	D.182
WDL 2.5/L	1030400000	D.79
WDL 2.5/L/L	1030300000	D.78
WDL 2.5/L/PE	1030200000	D.79
WDL 2.5/N/L/PE	1029900000	D.79
WDL 2.5/NT/L/PE	1029800000	D.78
WDL 2.5/S/L	1031300000	D.81
WDL 2.5/S/L/L	1031200000	D.80
WDL 2.5/S/L/PE	1031100000	D.81
WDL 2.5/S/N/L/PE	1030700000	D.81
WDL 2.5/S/NT/L/PE	1030600000	D.80
WDS 2	1069900000	D.179
WDT 1.5/1 DB/GE	1015800000	D.58
WDT 1.5/2 DB/GE	1015900000	D.58
WDT 1.5/3 BL/HB	1016160000	D.59
WDT 1.5/3 DB/GE	1016000000	D.59
WDR 2.5	9528070000	D.59
WDR 2.5 BL	9528080000	D.59
WDR 2.5 WE	1298020000	D.59
WDR 2.5 WE 0.5	9528090000	D.59
WDR 2.5 WE O.STB	1297850000	D.59
WDU 1.5/BLZ 5.08	1577340000	D.100
WDU 1.5/R3.5	1753280000	D.132
WDU 1.5/R3.5 BL	1754170000	D.132
WDU 1.5/ZOV/BLZ 5.08	1784460000	D.100
WDU 1.5/ZZ	1031400000	D.4
WDU 1.5/ZZ BL	1031480000	0.4
WDU 10	1020300000	D.8
WDU 10 BL	1020380000	D.8
WDU 10 GE	1833350000	D.181
WDU 10 GN	1833340000	D.181
WDU 10 OR	1020360000	D.181
WDU 10 RT	1020340000	D.181
WDU 10 SL	9537480000	D.87
WDU 10 SL SW	9537400000	D.87
WDU 10 SL/EN	9537490000	D.89
WDU 10 SL/EN SW	9537410000	D.89
WDU 10 SW	1020310000	D.181
WDU 10 WS	1833380000	D.181
WDU 10/ZR	1042400000	D.9
WDU 10/ZR BL	1042480000	D.9
WDU 120/150	1024500000	D.14
WDU 120/150 BL	1024580000	D.14
WDU 120/150/5	1026600000	D.182
WDU 120/150/5 N	1032400000	D.182
WDU 16 BL	1020480000	D.181
WDU 16 RT	1833400000	D.181

Type	Order No.	Page	Type	Order No.	Page	Type	Order No.	Page	Type	Order No.	Page
WF 5	1790130000	D.144	WPDB 120/35-16-10/1/2-5-4	1939470000	D.124	WQV 2,5/6	1054060000	D.168	WS 8/5 MC BEDRUCKT	1640750000	F.28
WF 6	1780850000	D.144	WPDB 16/6 3/4	1939440000	D.122	WQV 2,5/7	1054160000	D.168	WS 8/5 MC NEUTRAL	1640740000	F.28
WF 6/2BZ	1789770000	D.146	WPDB 185/35-16-10/1/2-5-4	1939480000	D.124	WQV 2,5/8	1054260000	D.168	WS 8/5 MC NEUTRAL BL	1773521693	F.28
WF 8	1780860000	D.145	WPDB 35-16/16 1-1/6	1939450000	D.122	WQV 2,5/9	1054360000	D.168	WS 8/5 MC NEUTRAL GE	1773521687	F.28
WF 8/2BZ	1789780000	D.146	WPDB 35/16/6/N 1/2/5/11	1939510000	D.126	WQV 35-10	1068000000	D.161	WS 8/5 MC NEUTRAL OR	1773521690	F.28
WFF 120	1028500000	D.149	WPDB 3x70/16 1/6	1939490000	D.125	WQV 35-2,5	1064100000	D.161	WS 8/5 MC NEUTRAL RT	1773521686	F.28
WFF 120 BL	1028580000	D.149	WPDB 70/16 1/10	1939460000	D.123	WQV 35/10	1053160000	D.10	WS 8/5 PLUS MC NEUTRAL	1951870000	F.28
WFF 120/AH	1029500000	D.149	WPDB 70/16 1/6	1939500000	D.126	WQV 35/2	1053060000	D.10	WS 8/5 PLUS MC SDR	1038790000	F.28
WFF 185	1028600000	D.149	WPE 1,5/R3.5	1798460000	D.133	WQV 35/3	1055360000	D.10	WS 8/6 PLUS MC NEUTRAL	1951880000	F.28
WFF 185 BL	1028680000	D.149	WPE 1,5/ZZ	1016500000	D.22	WQV 35/4	1055460000	D.10	WS 8/6 PLUS MC SDR	1038820000	F.29
WFF 185/AH	1029600000	D.149	WPE 10	1010300000	0.27	WQV 35N/2	1079200000	D.11	WSH 1	1068700000	E.8
WFF 300	1028700000	D.149	WPE 10/ZR	1042500000	0.28	WQV 35N/3	1079300000	D.11	WSH 18 MT	1083100000	E.9
WFF 300/AH	1029700000	D.149	WPE 120/150	1019700000	0.31	WQV 35N/4	1079400000	D.11	WSH 19 MT	1083200000	E.9
WFF 35	1028300000	D.148	WPE 16	1010400000	0.28	WQV 4/10	1052060000	D.168	WSH 3/H/N	1715970000	E.8
WFF 35 BL	1028380000	D.148	WPE 16N	1019100000	0.29	WQV 4/2	1051960000	D.168	WSH 4 MT	1079900000	E.10
WFF 35/AH	1029300000	D.148	WPE 2,5	1010000000	0.23	WQV 4/3	1054560000	D.168	WSH 5	1080100000	E.8
WFF 70	1028400000	D.148	WPE 2,5/1,5/ZR	1016400000	0.22	WQV 4/4	1054660000	D.168	WSH 6	1080200000	E.8
WFF 70 BL	1028480000	D.148	WPE 2,5N	1016200000	0.23	WQV 4/5	1057860000	D.168	WSH 25/1 CC	1966050000	D.46
WFF 70/AH	1029400000	D.148	WPE 35	1010500000	0.29	WQV 4/6	1057160000	D.168	WSI 25/1 CC/LED	1966070000	D.46
WGB 5 ABDG.M.GRUPPENBEZ	1050760000	F.33	WPE 35N	1717740000	0.29	WQV 4/7	1057260000	D.168	WSI 25/1 10x38	1966020000	D.46
WGB 8 ABDG.M.GRUPPENBEZ	1050960000	F.33	WPE 4	1010100000	0.24	WQV 50N/2	1834060000	D.12	WSI 25/1 10x38 1KV	1137790000	D.47
WHP 2,5-35N/10x3 BL	1050280000	D.82	WPE 4/ZR	1905120000	0.25	WQV 50N/3	1834070000	D.12	WSI 25/1 10x38/LED	1966060000	D.46
WHP WDL2,5/S BL	1067980000	D.80	WPE 4/ZZ	1905130000	0.25	WQV 50N/4	1834080000	D.12	WSI 25/1 10x38/LED 1KV	1137780000	D.47
WK 1/4 C8,3 E6,3	9202510000	F.61	WPE 4N	1042700000	0.25	WQV 6/10	1052260000	D.168	WSI 25/2 CC	1966040000	D.46
WK IK PH0	9918460000	F.62	WPE 50N	1846040000	0.30	WQV 6/2	1052360000	D.168	WSI 25/2 10x38	1966090000	D.46
WK IK PH1	9918470000	F.62	WPE 6	1010200000	0.27	WQV 6/3	1054760000	D.168	WSI 25/3 CC	1966030000	D.46
WK IK PH2	9918480000	F.62	WPE 70/95	1057300000	0.31	WQV 6/4	1054860000	D.168	WSI 25/3 10x38	1966080000	D.46
WK IK P20	9918490000	F.62	WPE 70N/35	9512200000	0.30	WQV 6/5	1062660000	D.168	WSI 4	1886580000	D.33
WK IK P21	9918500000	F.62	WPE 95N/120N	1846030000	0.31	WQV 6/6	1062670000	D.168	WSI 4/2	1880430000	D.32
WK IK P22	9918510000	F.62	WPO 4	1036000000	D.115	WQV 6/7	1062680000	D.168	WSI 4/2/LD 10-36V AC/DC	1880410000	D.32
WK K PH0	9918570000	F.61	WQB 240/2	1802790000	0.13	WQV 70/95-PEN	1072300000	D.31	WSI 4/2/LD 140-250V AC/DC	1880390000	D.32
WK K PH1	9918580000	F.61	WQB 240/3	1802800000	0.13	WQV 70/95/2	1063500000	D.14	WSI 4/2/LD 30-70V AC/DC	1880440000	D.32
WK K PH2	9918590000	F.61	WQB A/10	1578990000	D.172	WQV 70/95/3	1063600000	D.14	WSI 4/2/LD 60-150V AC/DC	1880420000	D.32
WK K P20	9918600000	F.61	WQB A/2	1578950000	D.172	WQV 70N-PEN	9525840000	D.30	WSI 4/LD 10-36V AC/DC	1886590000	D.33
WK K P21	9918610000	F.61	WQB A/24	1579000000	D.172	WQV 70N/2	9512240000	D.13	WSI 4/LD 140-250V AC/DC	1886550000	D.33
WK K P22	9918620000	F.61	WQB A/3	1579860000	D.172	WQV 70N/3	9512250000	D.13	WSI 4/LD 30-70V AC/DC	1886560000	D.33
WK S 0,4x2,5	9918520000	F.61	WQB A/4	1578970000	D.172	WQV 70N/4	9531290000	D.13	WSI 4/LD 60-150V AC/DC	1886570000	D.33
WK S 0,5x3,0	9918530000	F.61	WQB B/10	1579050000	D.172	WQV 95/120/2	1826890000	D.13	WSI 6	1011000000	D.35
WK S 0,6x3,5	9918540000	F.61	WQB B/2	1579010000	D.172	WQV 95/120/3	1826900000	D.13	WSI 6 BL	1011080000	D.181
WK S 0,8x4,0	9918550000	F.61	WQB B/24	1579060000	D.172	WQV 95/120/4	1826910000	D.13	WSI 6 OR	1011060000	D.181
WK S 1,0x5,5	9918560000	F.61	WQB B/3	1579020000	D.172	WQV PEN 50N	9201610000	D.30	WSI 6 SW	1011010000	D.181
WK SI 0,4x2,5	9918410000	F.62	WQB B/4	1579030000	D.172	WQV PEN 95N/120N	9201630000	D.31	WSI 6/2 GZ/DEF63	1014000000	D.37
WK SI 0,5x3,0	9918420000	F.62	WQB PEN 16N	1079600000	D.180	WS 10/12 MC NEUTRAL	1905970000	F.29	WSI 6/2/LD 10-36V DC/AC	1014100000	D.38
WK SI 0,6x3,5	9918430000	F.62	WQB PEN 35N	1079500000	D.180	WS 10/12 MC SONDERDRUCK	1906060000	F.29	WSI 6/2/LD 10-36V LLC	1119800000	D.43
WK SI 0,8x4,0	9918440000	F.62	WQB PEN 70N	1079700000	D.180	WS 10/15 MC Neutr.	1854090000	F.29	WSI 6/2/LD 250AC	1014400000	D.38
WK SI 1,0x5,5	9918450000	F.62	WQB-PEN 10	1060300000	D.180	WS 10/15 MC Sonderdruck	1854100000	F.29	WSI 6/2/LD 250AC LLC	1119790000	D.43
WKB 1/10	1604330000	D.71	WQB-PEN 16	1060200000	0.28	WS 10/5 MC BEDRUCKT	1635010000	F.28	WSI 6/2/LD 30-70V DC/AC	1014200000	D.38
WKB 1/2	1604280000	D.71	WQB-PEN 35	1060100000	0.29	WS 10/5 MC MIDD. NEUTR.	1792000000	F.28	WSI 6/2/LD 30-70V LLC	1119810000	D.43
WKB 1/3	1604300000	D.71	WQL 2 WF10	1781010000	D.150	WS 10/5 MC MIDD. SONDER	1792010000	F.28	WSI 6/2/LD 60-150V LLC	1119820000	D.43
WKB 1/4	1604320000	D.71	WQL 2 WF12	1781030000	D.145	WS 10/5 MC NEUTRAL	1635000000	F.28	WSI 6/2/LD 60-150VDC/AC	1014300000	D.38
WKS 1/2	1604270000	D.67	WQL 2 WF5	1812710000	D.144	WS 10/5 MC NEUTRAL BL	1773531693	F.28	WSI 6/LD 10-36V DC/AC	1011300000	D.36
WKS 1/3	1604290000	D.71	WQL 2 WF6	1780970000	D.150	WS 10/5 MC NEUTRAL GE	1773531687	F.28	WSI 6/LD 10-36V LLC	1119840000	D.42
WKS 1/4	1604310000	D.71	WQL 2 WF6-10	1806620000	D.150	WS 10/5 MC NEUTRAL RT	1773531686	F.28	WSI 6/LD 250AC	1012400000	D.36
WKS 2/2	1936140000	D.74	WQL 2 WF6-8	1809890000	D.150	WS 10/5 PLUS MC NE WS	1046380000	F.28	WSI 6/LD 250AC LLC	1119870000	D.42
WKS 2/3	1936150000	D.74	WQL 2 WF8	1780990000	D.150	WS 10/5 PLUS MC SDR	1046320000	F.28	WSI 6/LD 30-70V DC/AC	1012200000	D.36
WKS 2/4	1936160000	D.73	WQL 2 WFF120	1065100000	D.149	WS 10/6 MC Midd. Neutr.	1818400000	F.28	WSI 6/LD 30-70V LLC	1119830000	D.42
WMA 4/4	1034000000	D.182	WQL 2 WFF185	1065200000	D.149	WS 10/6 MC Midd. Sonder	1818410000	F.29	WSI 6/LD 60-150V DC/AC	1012300000	D.36
WMA 4/5	1033800000	D.182	WQL 2 WFF300	1065300000	D.149	WS 10/6 MC MIDDLE GE	1917430000	F.28	WSI 6/LD 60-150V LLC	1119850000	D.42
WMF 2,5	1143070000	D.106	WQL 2 WFF35	1064900000	D.148	WS 10/6 MC MIDDLE GN	1917420000	F.28	WTA 4AN/2	1107680000	D.102
WMF 2,5 BL	1270040000	D.106	WQL 2 WFF70	1065000000	D.148	WS 10/6 MC MIDDLE OR	1917410000	F.28	WTA 1 WDU1.5	1632290000	D.174
WMF 2,5 BLZ	1143050000	D.109	WQL 3 WF10	1781020000	D.150	WS 10/6 MC MIDDLE RT	1917440000	F.28	WTA 1/ZA WDU1.5	1632300000	D.174
WMF 2,5 DI	1143020000	D.106	WQL 3 WF12	1781040000	D.145	WS 10/6 MC NEUTRAL	1828450000	F.28	WTA 2 WDU2.5-10	1632320000	D.174
WMF 2,5 DI BL	1270070000	D.106	WQL 3 WF5	1812740000	D.144	WS 10/6 MC NEUTRAL BL	1828460000	F.29	WTA 2/10 WDU2.5/10	1632340000	D.174
WMF 2,5 DI BLZ	1143000000	D.109	WQL 3 WF6	1780980000	D.150	WS 10/6 PLUS MC NE WS	1046390000	F.28	WTA 2/ZA WDU2.5-10	1632330000	D.174
WMF 2,5 DI BLZ PE	1143010000	D.110	WQL 3 WF6-10/2	1806640000	D.150	WS 10/6 PLUS MC SDR	1046330000	F.29	WTA 3 WDU4	1632350000	D.174
WMF 2,5 DI PE	1143030000	D.107	WQL 3 WF8	1781000000	D.150	WS 10/8 PLUS MC NE WS	1905950000	F.29	WTA 3/ZA WDU4	1632360000	D.6
WMF 2,5 DI PE BL	1270080000	D.107	WQL 3 WFF120	1065600000	D.149	WS 10/8 PLUS MC SDR	1906030000	F.29	WTA 4N WDK 2.5	1878660000	D.175
WMF 2,5 FU 10-36V SW	1162930000	D.108	WQL 3 WFF185	1065700000	D.149	WS 12/3,5 MC neutral	1778270000	F.28	WTA 4N/ZA WDK 2.5	1879350000	D.175
WMF 2,5 FU 100-250V SW	1162960000	D.108	WQL 3 WFF300	1065800000	D.149	WS 12/3,5 MC Sonderdr.	1778280000	F.28	WTA 5/1	1051260000	D.175
WMF 2,5 FU 30-70V SW	1162940000	D.108	WQL 3 WFF35	1065400000	D.148	WS 12/5 MC BEDRUCKT	1609870000	F.28	WTA 6 WTR2.5	1632380000	D.174
WMF 2,5 FU 60-150V SW	1162950000	D.108	WQL 3 WFF70	1065500000	D.148	WS 12/5 MC NEUTRAL	1609860000	F.28	WTA 6/ZA WTR2.5	1632390000	D.174
WMF 2,5 FU BLZ 10-36V SW	1162990000	D.111	WQL 4 WF10	1027840000	D.145	WS 12/5 MC NEUTRAL BL	1773541693	F.28	WTA 7 WSI6	1650210000	D.174
WMF 2,5 FU BLZ 100-250V SW	1163020000	D.111	WQL 4 WF8-6/3	1904960000	D.150	WS 12/5 MC NEUTRAL GE	1773541687	F.28	WTA 8 KO-TN	1915480000	D.175
WMF 2,5 FU BLZ 30-70V SW	1163000000	D.111	WQV 10/10	1052460000	D.169	WS 12/5 MC NEUTRAL OR	1773541690	F.28	WTA 8 TN	1915450000	D.72
WMF 2,5 FU BLZ 60-150V SW	1163010000	D.111	WQV 10/2	1052560000	D.169	WS 12/5 MC NEUTRAL RT	1773541686	F.28	WTD 6 SL	9538090000	D.91
WMF 2,5 FU BLZ PE 10-36V SW	1162830000	D.111	WQV 10/3	1054960000	D.169	WS 12/5 PLUS MC NEUTRAL	1927510000	F.28	WTD 6 SL 0.STB	1238920000	D.68
WMF 2,5 FU BLZ PE 100-250V SW	1162860000	D.111	WQV 10/4	1055060000	D.169	WS 12/5 PLUS SONDERDRUCK	1927520000	F.28	WTD 6 SL/EN	9538100000	D.69
WMF 2,5 FU BLZ PE 30-70V SW	1162840000	D.111	WQV 120-PEN	1072400000	0.31	WS 12/6 MC BEDRUCKT	1609910000	F.29	WTD 6/1	1017100000	D.65
WMF 2,5 FU BLZ PE 60-150V SW	1162850000										

Type	Order No.	Page	Type	Order No.	Page	Type	Order No.	Page	Type	Order No.	Page
WTQ 6/1 EN	1934790000	D.73	ZAP/TW 1 OR	1608760000	C.130	ZB 4/6	0556700000	F.6	ZDU 10S	1739540000	C.73
WTQ 6/1 EN STB	1934800000	D.73	ZAP/TW 1 RT	1683660000	C.130	ZB 4/6K BL	0565480000	F.7	ZDU 10S BL	1739550000	C.73
WTR 2.5	1856610000	D.54	ZAP/TW 1 SW	1683730000	C.130	ZB 4/6K GE/GN	0565460000	F.7	ZDU 16	1745230000	C.11
WTR 2.5 BL	8731640000	D.54	ZAP/TW 10/16	1749580000	C.131	ZB 4G BL	0322180000	F.7	ZDU 16 BL	1745240000	C.11
WTR 2.5 STB2.3	1856620000	D.54	ZAP/TW 10/16 BL	1768520000	C.131	ZB 4G GN/GE	0322160000	F.7	ZDU 16 OR	1830680000	C.153
WTR 2.5 STB2.3 BL	8731660000	D.54	ZAP/TW 2 BL	1608780000	C.6	ZB 4G SW	0322110000	F.7	ZDU 16 SW	1830650000	C.153
WTR 2.5/0.TNHE	8731700000	D.54	ZAP/TW 2 DB	1608770000	C.130	ZB 4K BL	0475380000	F.7	ZDU 16/3AN	1768320000	C.11
WTR 2.5/0.TNHE STB2.3	8731670000	D.54	ZAP/TW 2 GN	1683760000	C.130	ZB 4K GE/GN	0475360000	F.7	ZDU 16/3AN BL	1768330000	C.11
WTR 2.5/SI	1763940000	D.50	ZAP/TW 2 OR	1608790000	C.130	ZBB ZDUB	1704740000	C.115	ZDU 16S	1739580000	C.73
WTR 2.5/SI LD 36V	1763950000	D.50	ZAP/TW 2 RT	1683740000	C.130	ZBE 6	0459500000	F.6	ZDU 16S BL	1739590000	C.73
WTR 2.5/ZZ	1039900000	D.55	ZAP/TW 3	1608800000	C.130	ZBE 6K BL	0525980000	F.7	ZDU 2.5	1608510000	C.6
WTR 2.5/ZZ BL	1039980000	D.55	ZAP/TW 3 BL	1608810000	C.7	ZBE 6K GE/GN	0525960000	F.7	ZDU 2.5 BL	1608520000	C.6
WTR 35 E	1045970000	D.77	ZAP/TW 3 GN	1683840000	C.130	ZBE 6K SW	0525910000	F.7	ZDU 2.5 BR	1683300000	C.152
WTR 4	7910180000	D.55	ZAP/TW 3 GR	1683870000	C.130	ZBS1 F.D SET	1764550000	C.149	ZDU 2.5 GE	1683270000	C.152
WTR 4 BL	7910190000	D.55	ZAP/TW 3 OR	1608820000	C.130	ZBW 1	1669620000	C.147	ZDU 2.5 GE/GN	1698780000	C.152
WTR 4 SI	7910240000	D.50	ZAP/TW 3 RT	1683820000	C.130	ZBW 1/3,5	1781930000	C.147	ZDU 2.5 GN	1683280000	C.152
WTR 4 SI SL	7910330000	D.90	ZAP/TW 3 SW	1683890000	C.130	ZBW 2	1650670000	C.147	ZDU 2.5 GR	1683310000	C.152
WTR 4 SL	7910270000	D.87	ZAP/TW 3 WS	1683880000	C.130	ZBW 3	1650680000	C.147	ZDU 2.5 OR	1636780000	C.152
WTR 4 STB	7910210000	D.55	ZAP/TW 4	1632090000	C.131	ZBW 4	1650690000	C.147	ZDU 2.5 RT	1683260000	C.152
WTR 4 STB BL	7910220000	D.55	ZAP/TW 4 BL	1632100000	C.8	ZBW 6	1650700000	C.147	ZDU 2.5 S	1808010000	C.72
WTR 4 STB SL	7910300000	D.87	ZAP/TW 4 GN	1683920000	C.131	ZBWW	1669630000	C.147	ZDU 2.5 S BL	1808020000	C.72
WTR 4/SI LD 150V	7914390000	D.50	ZAP/TW 4 OR	1632110000	C.131	ZDK 1.5	1791100000	C.20	ZDU 2.5 SW	1683330000	C.152
WTR 4/SI LD 250V	7914400000	D.50	ZAP/TW 4/3AN	7904100000	C.131	ZDK 1.5 BL	1791110000	C.20	ZDU 2.5 VI	1683290000	C.152
WTR 4/SI LD 36V	7914370000	D.50	ZAP/TW 4/3AN BL	7904110000	C.8	ZDK 1.5DU-PE	1791120000	C.21	ZDU 2.5 WS	1683320000	C.152
WTR 4/SI LD 70V	7914380000	D.50	ZAP/TW 4/3AN OR	7904120000	C.131	ZDK 1.5PE	1791150000	C.50	ZDU 2.5-2	1772060000	C.14
WTR 4/ZR	1905080000	D.57	ZAP/TW 5	1608830000	C.131	ZDK 1.5V	1791130000	C.20	ZDU 2.5-2 BL	1772070000	C.14
WTR 4/ZR STB	1905110000	D.57	ZAP/TW 5 BL	1608840000	C.9	ZDK 1.5V BL	1791140000	C.20	ZDU 2.5-2 OR	1772080000	C.152
WTR 4/ZZ	1905090000	D.56	ZAP/TW 5 OR	1608850000	C.131	ZDK 2.5	1674300000	C.22	ZDU 2.5-2/3AN	1706010000	C.14
WTR 4/ZZ STB	1905100000	D.56	ZAP/TW ZDK 2.5/3AN	1924910000	C.127	ZDK 2.5 BL	1678630000	C.22	ZDU 2.5-2/3AN BL	1706040000	C.14
WTR4 SL/EN	7910360000	D.89	ZAP/TW ZDK 1.5	1791160000	C.130	ZDK 2.5 EM	1768800000	C.123	ZDU 2.5-2/3AN GE	1946240000	C.152
WTR4 SL/EN STB	7910390000	D.89	ZAP/TW ZDK 1.5 BL	1791170000	C.130	ZDK 2.5 OR	1694140000	C.123	ZDU 2.5-2/3AN OR	1706050000	C.152
WTR4 SL/EN SW	7910380000	D.89	ZAP/TW ZDK 2.5	1674730000	C.130	ZDK 2.5-2	1790990000	C.28	ZDU 2.5-2/3AN RT	1946220000	C.152
WTR EN	1058800000	D.159	ZAP/TW ZDK 2.5 BL	1748800000	C.130	ZDK 2.5-2 BL	1791000000	C.28	ZDU 2.5-2/3AN SW	1946210000	C.152
WTW WF10/WF12	1780890000	D.151	ZAP/TW ZDK 2.5 OR	1690080000	C.130	ZDK 2.5-2 OR	1831260000	C.152	ZDU 2.5-2/3AN WS	1946230000	C.152
WTW WF10/WF12 2300	1780920000	D.151	ZAP/TW ZDK 2.5-2	1791050000	C.131	ZDK 2.5-2-PE	1791010000	C.51	ZDU 2.5-2/4AN	1706060000	C.15
WTW WF6	1781220000	D.144	ZAP/TW ZDK 2.5-2 BL	1791060000	C.28	ZDK 2.5-2V	1791030000	C.28	ZDU 2.5-2/4AN BL	1706070000	C.15
WTW WF6 2300	1781230000	D.151	ZAP/TW ZDK 2.5-2 OR	1791070000	C.131	ZDK 2.5-2V BL	1791040000	C.28	ZDU 2.5-2/4AN OR	1706080000	C.152
WTW WF6-WF12	1781240000	D.144	ZAP/TW ZDK 4-2	8670760000	C.126	ZDK 2.5/3AN	1924510000	C.32	ZDU 2.5-2/D-	1779000000	C.122
WTW WF8	1780900000	D.145	ZAP/TW ZDK 4-2 BL	8670620000	C.126	ZDK 2.5/3AN BL	1924500000	C.32	ZDU 2.5-2/D+	1779110000	C.122
WTW WF8 2300	1780910000	D.151	ZAP/TW ZDKPE2.5-2	1805960000	C.29	ZDK 2.5/3AN D2	1924450000	C.127	ZDU 2.5-2/2X2AN	1608600000	C.7
WTW WF120	1067300000	D.149	ZAP/TW ZDL02.5-2N	1782340000	C.131	ZDK 2.5/3AN DU-PE	1924460000	C.33	ZDU 2.5/2X2AN BL	1608610000	C.7
WTW WF195/300	1067400000	D.149	ZAP/TW ZDL02.5-2N BL	1782350000	C.131	ZDK 2.5/3AN PE	1924470000	C.52	ZDU 2.5/2X2AN OR	1636810000	C.152
WTW WF35	1067100000	D.148	ZAP/TW ZDL02.5-2N OR	1782360000	C.131	ZDK 2.5/3AN V	1924490000	C.32	ZDU 2.5/2X2AN/D-	1650350000	C.121
WTW WF70	1067200000	D.148	ZAP/TW ZDT2.5/2	1816110000	C.133	ZDK 2.5/3AN V BL	1924480000	C.32	ZDU 2.5/2X2AN/D+	1650340000	C.121
WTW WTL6/1 DB	1068400000	D.73	ZAP/TW ZDU/ZPE 2.5N	1933790000	C.18	ZDK 2.5/D/1	1690020000	C.124	ZDU 2.5/2X2AN/LD	1692600000	C.120
WZA D120	1066100000	D.13	ZAP/TW ZDU/ZPE 2.5N/3AN	1933800000	C.18	ZDK 2.5/D/2	1690030000	C.124	ZDU 2.5/2X2AN/LD+	1692590000	C.120
WZAD 240	1802810000	D.14	ZAP/TW ZDU/ZPE 2.5N/4AN	1933810000	C.19	ZDK 2.5/D/4	1690040000	C.125	ZDU 2.5/3AN	1608540000	C.6
WZAD 50N	1872720000	D.12	ZAP/TW ZDU1.5/2AN	1776030000	C.130	ZDK 2.5/D/5	1690050000	C.125	ZDU 2.5/3AN BL	1608550000	C.6
WZAD 70/95	1066000000	D.14	ZAP/TW ZDU1.5/2AN BL	1776040000	C.4	ZDK 2.5/D/6	1690060000	C.125	ZDU 2.5/3AN GE	1683350000	C.152
WZAD 70N	1964830000	D.13	ZAP/TW ZDU1.5/2AN OR	1776050000	C.130	ZDK 2.5/D/RT/1	1690010000	C.123	ZDU 2.5/3AN GE/GN	1698790000	C.152
WZAD 95N/120N	1859580000	D.13	ZAP/TW ZDU1.5/3AN	1776060000	C.130	ZDK 2.5/D/RT/2	1693940000	C.123	ZDU 2.5/3AN GN	1683360000	C.152
WZAF 120	1066300000	D.179	ZAP/TW ZDU1.5/3AN BL	1776070000	C.4	ZDK 2.5DU-PE	1689970000	C.23	ZDU 2.5/3AN GR	1683390000	C.152
WZAF 185	1066400000	D.179	ZAP/TW ZDU1.5/3AN OR	1776080000	C.130	ZDK 2.5N-DU	1689960000	C.23	ZDU 2.5/3AN OR	1636790000	C.152
WZAF 300	1066500000	D.179	ZAP/TW ZDU1.5/4AN	1776090000	C.130	ZDK 2.5N-PE	1689980000	C.23	ZDU 2.5/3AN RT	1683440000	C.152
WZAF 35	1070500000	D.179	ZAP/TW ZDU1.5/4AN BL	1776100000	C.5	ZDK 2.5PE	1690000000	C.50	ZDU 2.5/3AN SW	1683410000	C.152
WZAF 70	1066200000	D.179	ZAP/TW ZDU1.5/4AN OR	1776110000	C.130	ZDK 2.5V	1689990000	C.22	ZDU 2.5/3AN WS	1683400000	C.152
Z			ZAP/TW ZDU10	1748660000	C.131	ZDK 2.5V BL	1745880000	C.22	ZDU 2.5/4AN	1608570000	C.7
ZAD 1/4	1609110000	C.146	ZAP/TW ZDU10 BL	1764110000	C.10	ZDK 4-2	8670750000	C.30	ZDU 2.5/4AN BL	1608580000	C.7
ZAD 1/4-2 GE	1764560000	C.147	ZAP/TW ZDU16	1745150000	C.131	ZDK 4-2 BL	8670850000	C.30	ZDU 2.5/4AN BR	1683460000	C.152
ZAD 2/4	1609800000	C.147	ZAP/TW ZDU16 BL	1764100000	C.11	ZDK 4-2 EL	8709760000	C.126	ZDU 2.5/4AN GE	1683430000	C.152
ZAD 3/4	1609120000	C.147	ZAP/TW ZDUA	1720960000	C.117	ZDK 4-2 PE	8671050000	C.51	ZDU 2.5/4AN GE/GN	1692240000	C.152
ZAD 4/5	1746730000	C.10	ZAP/TW ZDUA BL	1720970000	C.117	ZDK 4-2 V	8671080000	C.30	ZDU 2.5/4AN GN	1683440000	C.152
ZAD 5/5	1745210000	C.11	ZAP/TW ZDUA OR	1720980000	C.117	ZDK 4-2/2AN	1119700000	C.31	ZDU 2.5/4AN GR	1683470000	C.152
ZAD 6/5	1752620000	C.12	ZAP/TW ZDUA2.5-2N	1808170000	C.118	ZDK 4-2/D forward	8670520000	C.126	ZDU 2.5/4AN OR	1636800000	C.152
ZAD 7/4	1781940000	C.146	ZAP/TW ZIA1.5/3L	1649540000	C.110	ZDK 4-2/DU-PE	8671120000	C.31	ZDU 2.5/4AN RT	1683420000	C.152
ZAD 9/4	1934160000	C.147	ZAP/TW ZIA1.5/4L	1649550000	C.111	ZDK 4-2/N/L	1905170000	C.31	ZDU 2.5/4AN SW	1683490000	C.152
ZAD Z1/2PS2.5	1861030000	C.100	ZAP/TW ZPV1.5	1674650000	C.110	ZDKPE 2.5-2	1805940000	C.29	ZDU 2.5/4AN WS	1683480000	C.152
ZAP TNHE/ZSI2.5	1610840000	C.54	ZAP/TW ZT2.5/2AN	1816030000	C.133	ZDKPE 2.5-2/N/L/PE	1895700000	C.29	ZDU 2.5N	1933700000	C.18
ZAP TW 2.5 S	1808030000	C.132	ZAP/TW ZT2.5/2AN OR	1816040000	C.133	ZDL0 2.5-2N	1782300000	C.24	ZDU 2.5N BL	1933710000	C.18
ZAP ZDU 2.5 BL	1808040000	C.72	ZAP/TW ZT2.5/3AN	1816050000	C.133	ZDL0 2.5-2N BL	1782310000	C.24	ZDU 2.5N/3AN	1933720000	C.18
ZAP ZDU 2.5 S OR	1808050000	C.132	ZAP/TW ZT2.5/3AN OR	1816060000	C.82	ZDL0 2.5-2N PE	1131740000	C.25	ZDU 2.5N/3AN BL	1933730000	C.18
ZAP ZDU 4 S	1808380000	C.132	ZAP/TW ZT2.5/4AN/2	1816070000	C.133	ZDL0 2.5-2N/PE/L/L	1131750000	C.25	ZDU 2.5N/4AN	1933740000	C.19
ZAP ZDU 4 S BL	1808390000	C.72	ZAP/TW ZT2.5/4AN/2 OR	1816080000	C.133	ZDL0 2.5-2N/PE/L/N	1131760000	C.25	ZDU 2.5N/4AN BL	1933750000	C.19
ZAP ZDU 6 S	1808250000	C.132	ZAP/TW ZT2.5/4AN/4	1816090000	C.133	ZDL0 2.5-2V	1782320000	C.24	ZDU 35	1739620000	C.12
ZAP ZDU 6 S BL	1808260000	C.132	ZAP/TW ZT4/2AN	1855220000	C.85	ZDL0 2.5-2V BL	1782330000	C.24	ZDU 35 BL	1739630000	C.12
ZAP ZDU10/16S	1739660000	C.132	ZAP/TW ZT4/2AN OR	1855230000	C.85	ZDT 2.5/2	1815150000	C.90	ZDU 35 OR	1830760000	C.153
ZAP ZDU4-2	1770400000	C.131	ZAP/TW ZT4/4AN/2 OR	1855240000	C.85	ZDT 2.5/2 DU-PE	1815160000	C.91	ZDU 4	1632050000	C.8
ZAP ZDU4-2 BL	1770880000	C.131	ZAP/TW ZTR2.5	1865520000	C.93	ZDT 2.5/2 PE	1815170000	C.92	ZDU 4 BL	1632060000	C.8
ZAP ZDU4-2 OR	1770890000	C.131	ZAP/TW4/4AN	7904210000	C.131	ZDT 2.5/2 DU	1259120000	C.90	ZDU 4 BR	1683620000	C.153
ZAP ZDU4-2/4AN	1807010000	C.131	ZAP/TW4/4AN BL	7904220000	C.9	ZDTR 2.5	1745400000	C.67	ZDU 4 GE	1683590000	C.153
ZAP ZDU4-2/4AN BL	1807020000	C.16	ZAP/TW4/4AN OR	7904230000	C.131	ZDTR 2.5 BL	1798330000	C.67	ZDU 4 GE/GN	1698770000	C.153
ZAP ZDU4-2/4AN OR	1807030000	C.131	ZAP/TW6/3AN	79073700							

Type	Order No.	Page	Type	Order No.	Page	Type	Order No.	Page	Type	Order No.	Page
ZDU 4/4AN BL	7904300000	C.9	ZP 2.5/1AN/12 GN/BE	1867190000	C.96	ZPE 1.5/4AN	1775620000	C.37	ZQV 2.5N/8 GE	1693860000	C.140
ZDU 4/4AN OR	8670210000	C.153	ZP 2.5/1AN/13	1815590000	C.96	ZPE 10	1746770000	C.41	ZQV 2.5N/8 RT	1717960000	D.165
ZDU 4/NT	1757980000	C.76	ZP 2.5/1AN/13 GN/BE	1867200000	C.96	ZPE 10/3AN	1767670000	C.41	ZQV 2.5N/8 SW	1718140000	D.165
ZDU 4/NT DB	1778080000	C.76	ZP 2.5/1AN/14	1815600000	C.96	ZPE 10S	1739570000	C.78	ZQV 2.5N/9 BL	1718060000	D.165
ZDU 6	1608620000	C.9	ZP 2.5/1AN/14 GN/BE	1867210000	C.96	ZPE 16	1745250000	C.42	ZQV 2.5N/9 GE	1693870000	C.140
ZDU 6 BL	1608630000	C.9	ZP 2.5/1AN/15	1815610000	C.96	ZPE 16/2/1AN	1772960000	C.47	ZQV 2.5N/9 RT	1717970000	D.165
ZDU 6 OR	1636820000	C.153	ZP 2.5/1AN/15 GN/BE	1867220000	C.96	ZPE 16/3AN	1768310000	C.42	ZQV 2.5N/9 SW	1718150000	D.165
ZDU 6 RT	1830420000	C.153	ZP 2.5/1AN/16	1815620000	C.96	ZPE 16S	1739610000	C.79	ZQV 35/10	7920100000	C.140
ZDU 6 S	1808230000	C.73	ZP 2.5/1AN/17	1815180000	C.96	ZPE 2.5	1608640000	C.37	ZQV 35/2	1739700000	C.12
ZDU 6 S BL	1808240000	C.73	ZP 2.5/1AN/17 GN/BE	1867240000	C.96	ZPE 2.5 S	1808330000	C.77	ZQV 4/10 GE	1609030000	C.140
ZDU 6-2/2AN	1771380000	C.17	ZP 2.5/1AN/2	1815440000	C.83	ZPE 2.5-2	1772090000	C.44	ZQV 4/2 GE	1608950000	C.140
ZDU 6-2/2AN BL	1771390000	C.17	ZP 2.5/1AN/2 GN/BE	1867090000	C.96	ZPE 2.5-2/3AN	1706090000	C.44	ZQV 4/20 GE	1909010000	C.140
ZDU 6-2/2AN OR	1771400000	C.153	ZP 2.5/1AN/24	1815720000	C.96	ZPE 2.5-2/4AN	1706100000	C.45	ZQV 4/3 GE	1608960000	C.140
ZDU 6-2/3AN	1771410000	C.17	ZP 2.5/1AN/3	1815450000	C.83	ZPE 2.5/3AN	1608650000	C.37	ZQV 4/4 GE	1608970000	C.140
ZDU 6-2/3AN BL	1771420000	C.17	ZP 2.5/1AN/3 GN/BE	1867100000	C.96	ZPE 2.5/4AN	1608660000	C.38	ZQV 4/5 GE	1608980000	C.140
ZDU 6-2/3AN OR	1771430000	C.153	ZP 2.5/1AN/4	1815500000	C.83	ZPE 2.5N	1933760000	C.48	ZQV 4/6 GE	1608990000	C.140
ZDU 6/3AN	7907410000	C.9	ZP 2.5/1AN/4 GN/BE	1867110000	C.96	ZPE 2.5N/3AN	1933770000	C.48	ZQV 4/7 GE	1609000000	C.140
ZDU 6/3AN BL	7907420000	C.9	ZP 2.5/1AN/5	1815510000	C.83	ZPE 2.5N/4AN	1933780000	C.49	ZQV 4/8 GE	1609010000	C.140
ZDU 6/3AN OR	8670420000	C.153	ZP 2.5/1AN/5 GN/BE	1867120000	C.96	ZPE 35	1739650000	C.43	ZQV 4/9 GE	1609020000	C.140
ZDUA 2.5-2	1720920000	C.117	ZP 2.5/1AN/6	1815520000	C.96	ZPE 4	1632080000	C.38	ZQV 4N/10 BL	1794050000	D.165
ZDUA 2.5-2 BL	1720930000	C.117	ZP 2.5/1AN/6 GN/BE	1867130000	C.96	ZPE 4 S	1808340000	C.77	ZQV 4N/10 GE	1758260000	D.165
ZDUA 2.5-2 OR	1720940000	C.117	ZP 2.5/1AN/7	1815530000	C.83	ZPE 4/2/2AN	1770380000	C.45	ZQV 4N/10 RT	1794040000	D.165
ZDUA 2.5-2N	1808200000	C.118	ZP 2.5/1AN/7 GN/BE	1867140000	C.96	ZPE 4/2/3AN	1770390000	C.45	ZQV 4N/10 SW	1794060000	D.165
ZDUA 2.5-2N BL	1808180000	C.118	ZP 2.5/1AN/8	1815540000	C.83	ZPE 4/2/4AN	1807090000	C.46	ZQV 4N/2 BL	1793960000	D.165
ZDUB 2.5-2/2AN/15	1712750000	C.116	ZP 2.5/1AN/8 GN/BE	1867150000	C.96	ZPE 4/3AN	7904170000	C.39	ZQV 4N/2 GE	1758250000	D.165
ZDUB 2.5-2/2AN/15 BL	1712760000	C.116	ZP 2.5/1AN/9	1815550000	C.83	ZPE 4/4AN	7904280000	C.39	ZQV 4N/2 RT	1793950000	D.165
ZDUB 2.5-2/2AN/15 OR	1712770000	C.116	ZP 2.5/1AN/9 GN/BE	1867160000	C.96	ZPE 6	1608670000	C.40	ZQV 4N/2 SW	1793970000	D.165
ZDUB 2.5-2/2AN/DB	1704500000	C.115	ZP 2.5/1AN/OV	1007900000	C.98	ZPE 6 S	1808350000	C.78	ZQV 4N/20 BL	1909100000	D.165
ZDUB 2.5-2/2AN/DB BL	1704510000	C.115	ZP 2.5/1AN/OV BL	1007910000	C.98	ZPE 6/2/2AN	1771370000	C.46	ZQV 4N/20 GE	1909020000	D.165
ZDUB 2.5-2/2AN/DB GE	1704530000	C.115	ZP 2.5/1AN/OV GN	1007920000	C.98	ZPE 6/2/3AN	1771360000	C.47	ZQV 4N/20 RT	1909150000	D.165
ZDUB 2.5-2/2AN/DM	1704350000	C.115	ZP 2.5/1AN/OV ZA	1007930000	C.98	ZPE 6/3AN	7907400000	C.40	ZQV 4N/20 SW	1909120000	D.165
ZDUB 2.5-2/2AN/DM BL	1704360000	C.115	ZP 2.5/1AN/OV ZA BL	1007940000	C.98	ZPEA 2.5-2	1720950000	C.117	ZQV 4N/3 BL	1793990000	D.165
ZDUB 2.5-2/2AN/DM GE	1704380000	C.115	ZP 2.5/1AN/OV ZA GN	1007950000	C.98	ZPEA 2.5-2N	1808210000	C.118	ZQV 4N/3 GE	1762630000	D.165
ZDUB 2.5-2/2AN/DM OR	1704370000	C.115	ZP 2.5/1AN/OV ZA O.RA	1007960000	C.98	ZPEB 2.5-2	1712810000	C.117	ZQV 4N/3 RT	1793980000	D.165
ZDUB 2.5-2/2AN/RC	1712820000	C.114	ZP 2.5/1AN/OV ZAO.RA BL	1007970000	C.98	ZPS 2.5/1AN/OV/1	1861040000	C.99	ZQV 4N/3 SW	1794000000	D.165
ZDUB 2.5-2/2AN/RC BL	1712830000	C.114	ZP 2.5/1AN/OV ZAO.RA GN	1007980000	C.98	ZPS 2.5/1AN/OV/1 GN	1861050000	C.99	ZQV 4N/4 BL	1794020000	D.165
ZDUB 2.5-2/2AN/RC GE	1712850000	C.114	ZP 2.5/1AN/OV/1	1815190000	C.97	ZPS 2.5/1AN/OV/6	1865940000	C.103	ZQV 4N/4 GE	1762620000	D.165
ZDUB 2.5-2/2AN/RC OR	1712840000	C.114	ZP 2.5/1AN/OV/1 GN	1820570000	C.97	ZPV 1.5	1676630000	C.110	ZQV 4N/4 RT	1794010000	D.165
ZDUB 2.5-2/4AN/15	1712780000	C.116	ZP 2.5/1AN/OV/10	1815280000	C.97	ZQV 2.5-2	1677120000	C.140	ZQV 4N/4 SW	1794030000	D.165
ZDUB 2.5-2/4AN/15 BL	1712790000	C.116	ZP 2.5/1AN/OV/11	1815290000	C.97	ZQS 2.5/2	1633200000	C.141	ZQV 6/2 GE	1627850000	C.141
ZDUB 2.5-2/4AN/15 OR	1712800000	C.116	ZP 2.5/1AN/OV/12	1815300000	C.97	ZQS 2.5/3	1633210000	C.141	ZQV 6/24 GE	1908990000	C.141
ZDUB 2.5-2/4AN/DB	1704690000	C.115	ZP 2.5/1AN/OV/13	1815310000	C.97	ZQS 2.5/4	1633220000	C.141	ZQV 6/3 GE	1627860000	C.141
ZDUB 2.5-2/4AN/DB BL	1704700000	C.115	ZP 2.5/1AN/OV/14	1815320000	C.97	ZQS 2.5/5	1633230000	C.141	ZQV 6/4 GE	1627870000	C.141
ZDUB 2.5-2/4AN/DB GE	1704720000	C.115	ZP 2.5/1AN/OV/15	1815330000	C.97	ZQV 1.5/10	1776200000	C.140	ZQV 6N/2	1906210000	B.5
ZDUB 2.5-2/4AN/DM	1704540000	C.115	ZP 2.5/1AN/OV/16	1815340000	C.97	ZQV 1.5/2	1776120000	C.140	ZQV 6N/20	1906240000	B.5
ZDUB 2.5-2/4AN/DM BL	1704550000	C.115	ZP 2.5/1AN/OV/17	1815350000	C.97	ZQV 1.5/3	1776130000	C.140	ZQV 6N/3	1906220000	B.5
ZDUB 2.5-2/4AN/DM GE	1704570000	C.115	ZP 2.5/1AN/OV/2	1815200000	C.97	ZQV 1.5/4	1776140000	C.140	ZQV 6N/4	1906230000	B.5
ZDUB 2.5-2/4AN/DM OR	1704560000	C.115	ZP 2.5/1AN/OV/3	1815210000	C.97	ZQV 1.5/5	1776150000	C.140	ZR WP04 DB	1071100000	D.115
ZDUB 2.5-2/4AN/RC	1712970000	C.114	ZP 2.5/1AN/OV/4	1815220000	C.97	ZQV 1.5N/R3.5/10 GE	1754290000	D.132	ZRH 1.5H/1	1678810000	C.148
ZDUB 2.5-2/4AN/RC BL	1712980000	C.114	ZP 2.5/1AN/OV/5	1815230000	C.97	ZQV 1.5N/R3.5/2 GE	1754210000	D.132	ZRH 1.5H/2	1678800000	C.148
ZDUB 2.5-2/4AN/RC GE	1713000000	C.114	ZP 2.5/1AN/OV/6	1815240000	C.97	ZQV 1.5N/R3.5/3 GE	1754220000	D.132	ZRH 1.5N/1	1632140000	C.148
ZDUS	1676640000	C.149	ZP 2.5/1AN/OV/7	1815250000	C.97	ZQV 1.5N/R3.5/4 GE	1754230000	D.132	ZRH 1.5N/2	1632130000	C.148
ZE ZRV2.5	2318670000	C.95	ZP 2.5/1AN/OV/8	1815260000	C.97	ZQV 10/2	1739680000	C.141	ZRH 1.5S/1	1781950000	C.148
ZEI 16	1745350000	C.11	ZP 2.5/1AN/OV/9	1815270000	C.97	ZQV 16/2	1739690000	C.141	ZRH 1.5S/2	1781960000	C.148
ZEI 16 BL	1766240000	C.11	ZP 2.5/2AN/OV	1007810000	C.99	ZQV 2.5/10	1608940000	C.140	ZRH 2.5/1 WS	1614300000	C.148
ZEI 16-2/1AN	1772940000	C.17	ZP 2.5/2AN/OV BL	1007820000	C.99	ZQV 2.5/2	1608860000	C.140	ZRH 2.5/2 GR/V0	1614290000	C.148
ZEI 16-2/1AN BL	1772950000	C.17	ZP 2.5/2AN/OV GN	1007830000	C.99	ZQV 2.5/20	1908960000	C.140	ZRH 2.5/3	1614280000	C.148
ZEI 16	1791190000	C.5	ZP 2.5/2AN/OV ZA	1007840000	C.99	ZQV 2.5/3	1608870000	C.140	ZRH 4/1 WS	1636640000	C.148
ZEI 15	7920340000	F.12	ZP 2.5/2AN/OV ZA BL	1007850000	C.99	ZQV 2.5/4	1608880000	C.140	ZRH 4/2	1636650000	C.148
ZEW 35	9540000000	F.12	ZP 2.5/2AN/OV ZA GN	1007860000	C.99	ZQV 2.5/5	1608890000	B.49	ZRV 1.5	1698160000	C.94
ZEW 35 GR	1238040000	F.12	ZP 2.5/2AN/OV ZA O.RA	1007870000	C.99	ZQV 2.5/50	1697540000	C.110	ZRV 1.5/PE	1698170000	C.94
ZEW 35/2	8630740000	F.12	ZP 2.5/2AN/OV ZAO.RA BL	1007880000	C.99	ZQV 2.5/6	1608900000	B.49	ZRV 2.5/1	1906960000	C.95
ZEW 35/2 GR	1227850000	F.12	ZP 2.5/2AN/OV ZAO.RA GN	1007890000	C.99	ZQV 2.5/7	1608910000	B.49	ZRV 2.5/2	1906970000	C.95
ZEW 35/2 SW	1162610000	F.12	ZP 2.5/2AN/OV/1	1815730000	C.97	ZQV 2.5/8	1608920000	B.49	ZS 10/5 MC BEDRUCKT	1610010000	F.29
ZF 4 S	1814680000	F.7	ZP 2.5/2AN/OV/1 GN	1820590000	C.97	ZQV 2.5/9	1608930000	B.49	ZS 10/5 MC NEUTRAL	1610000000	F.29
ZF 4 S BL	1814690000	F.7	ZP 2.5/2AN/OV/10	1815820000	C.97	ZQV 2.5N/10 BL	1718070000	D.165	ZS 12/6 BEDRUCKT	1610030000	F.29
ZF 4 S GN	1814670000	F.7	ZP 2.5/2AN/OV/11	1815830000	C.97	ZQV 2.5N/10 GE	1693880000	D.165	ZS 12/6 MC NEUTRAL	1610020000	F.29
ZGB 15	1636630000	F.34	ZP 2.5/2AN/OV/12	1815840000	C.97	ZQV 2.5N/10 RT	1717980000	D.165	ZS 15/5 MC BEDRUCKT	1646640000	F.29
ZGB 30	1611930000	F.34	ZP 2.5/2AN/OV/13	1815850000	C.97	ZQV 2.5N/10 SW	1718160000	D.165	ZS 15/5 MC NEUTRAL	1646630000	F.29
ZHP S	1808290000	C.132	ZP 2.5/2AN/OV/14	1815860000	C.97	ZQV 2.5N/2 BL	1717990000	D.165	ZSI 2.5	1616400000	C.54
ZHP S SO	1808280000	C.132	ZP 2.5/2AN/OV/15	1815870000	C.97	ZQV 2.5N/2 GE	1693800000	D.165	ZSI 2.5-2/2X2AN/G20	1826050000	C.58
ZHP ZDUA/NT SO	1803890000	C.76	ZP 2.5/2AN/OV/16	1815880000	C.97	ZQV 2.5N/2 RT	1717900000	D.165	ZSI 2.5-2/2X2AN/G20/GL	1826030000	C.58
ZIA 1.5/3L-1S	1651980000	C.110	ZP 2.5/2AN/OV/2	1815740000	C.97	ZQV 2.5N/2 SW	1718080000	D.165	ZSI 2.5-2/2X2AN/G20/LD1	1867440000	C.59
ZIA 1.5/3L-1S/LD-RT	1651990000	C.110	ZP 2.5/2AN/OV/3	1815750000	C.97	ZQV 2.5N/20 BL	1909140000	D.165	ZSI 2.5-2/2X2AN/G20/LD3	1867420000	C.59
ZIA 1.5/3L-PE	1652000000	C.110	ZP 2.5/2AN/OV/4	1815760000	C.97	ZQV 2.5N/20 GE	1909000000	D.165	ZSI 2.5-2/2X2AN/G20/LD4	1879730000	C.59
ZIA 1.5/4L-1S	1652010000	C.111	ZP 2.5/2AN/OV/5	1815770000	C.97	ZQV 2.5N/20 RT	1909110000	D.165	ZSI 2.5-2/2X2AN/G25	1826200000	C.58
ZIA 1.5/4L-1S/LD	1652020000	C.111	ZP 2.5/2AN/OV/6	1815780000	C.97	ZQV 2.5N/20 SW	1909130000	D.165	ZSI 2.5-2/2X2AN/G25/GL	1826090000	C.58
ZIA 1.5/4L-PE	1652030000	C.111	ZP 2.5/2AN/OV/7	1815790000	C.97	ZQV 2.5N/3 BL	1718000000	D.165			

Type	Order No.	Page
ZT 2.5/2AN/1	1815070000	C.82
ZT 2.5/2X2AN	1967200000	C.83
ZT 2.5/3AN/1	1815090000	C.82
ZT 2.5/4AN/2	1815110000	C.83
ZT 2.5/4AN/4	1815130000	C.83
ZT 4/2AN/1	1854960000	C.85
ZT 4/4AN/2	1848350000	C.85
ZTA 1	1609040000	C.142
ZTA 1/ZA	1609050000	C.142
ZTA 2 ZDU4	1609060000	C.142
ZTA 2/ZA ZDU4	1609070000	C.142
ZTA 3 ZDU6	1654050000	C.142
ZTA 4	1688110000	C.143
ZTA 5	1776210000	C.143
ZTA 5/ZA	1776220000	C.143
ZTA 6/ZA	1780660000	C.142
ZTA 7/ZA	1780670000	C.142
ZTA ZT2.5	1827080000	C.142
ZTA ZT2.5/ZA	1847600000	C.142
ZTA ZVLD	1210390000	C.26
ZTA ZVLD/ZA	1271870000	C.26
ZTC 2.5/4AN/4	1898450000	C.84
ZTCPE 2.5/4AN/4	1898480000	C.87
ZTD 6	1771810000	C.68
ZTD 6/STB	1771960000	C.69
ZTL 6	1771800000	C.68
ZTL 6/STB	1771950000	C.69
ZTPE 2.5/2AN/1	1815080000	C.86
ZTPE 2.5/3AN/1	1815100000	C.86
ZTPE 2.5/4AN/2	1815120000	C.87
ZTPE 2.5/4AN/4	1815140000	C.87
ZTPE 4/2AN/1	1854970000	C.88
ZTPE 4/4AN/2	1848330000	C.88
ZTR 2.5	1831280000	C.66
ZTR 2.5 BL	8731710000	C.66
ZTR 2.5 OR	8731680000	C.66
ZTR 2.5-2	1779010000	C.70
ZTR 2.5-2 BL	1779120000	C.70
ZTR 2.5-2 OR	1779130000	C.70
ZTR 2.5-2/O.TNHE	1779020000	C.70
ZTR 2.5/3AN	8731720000	C.66
ZTR 2.5/3AN BL	8731730000	C.66
ZTR 2.5/3AN OR	8731690000	C.66
ZTR 2.5/3AN/O.TNHE	8728450000	C.66
ZTR 2.5/4AN	7920900000	C.67
ZTR 2.5/4AN BL	7920930000	C.67
ZTR 2.5/4AN OR	7920940000	C.67
ZTR 2.5/4AN/O.TNHE	7920950000	C.67
ZTR 2.5/O.TNHE	1831130000	C.66
ZTR 6-2	1023830000	C.70
ZTR 6-2 E / 230V UC	8817930000	C.71
ZTR 6-2 E / 24V DC	8817920000	C.71
ZTTR 2.5	1865510000	C.93
ZTTR 2.5 O.TNHE	1905470000	C.93
ZTW ZDUB	1704340000	C.132
ZTW ZTL6	1771870000	C.133
ZTW ZTL6 OR	1771880000	C.133
ZVL 1.5	1649300000	C.111
ZVL 1.5 BL	1650360000	C.111
ZVL 1.5 BR	1650370000	C.111
ZVL 1.5 O.QV	1711930000	C.111
ZVL 1.5/PE GN/GE BED	1651970000	C.111
ZVLA DF ZPS2.5	1878600000	C.104
ZVLA RC ZPS2.5	1866260000	C.105
ZVLA SC ZPS2.5	1866240000	C.105
ZVLA1 ZPS2.5	1866250000	C.103
ZVLD 2.5	1208920000	C.26
ZVQ 2.5/1.5	1720700000	C.141
ZVR ZP2.5	1816130000	C.103
ZVR ZP4	1855250000	D.102
ZVR ZPS2.5	1878620000	C.100
ZZA 2.5	1646690000	C.149
ZZA 2.5/ZA	1649350000	C.149
ZZE ZP2.5	1816140000	C.103
ZZE ZP2.5/4	1866220000	C.100
ZZE ZP2.5/8	1866230000	C.100
ZZE ZP4	1855260000	D.102

Order No.	Type	Page
-----------	------	------

010000000

0101700000	TST 2/M6	F.13
0103300000	BFSC M4X9T	F.4

011000000

0117500000	TS 15X5/L2M/ST/ZN	F.9
0117510000	TS 15X5/L1M/ST/ZN	F.9

012000000

0122800000	TS 32X15 2M/ST/ZN	F.9
0124300000	H16,0/15	F.77
0124400000	H25,0/15	F.77
0124700000	H6,0/15	F.77
0124800000	H10,0/15	F.77

013000000

0132660010	DEK 5 FW 10-500	F.21
0132961021	DEK 5 GS A	F.21
0132961022	DEK 5 GS B	F.21
0132961023	DEK 5 GS C	F.21
0132961024	DEK 5 GS D	F.21
0132961025	DEK 5 GS E	F.21
0132961026	DEK 5 GS F	F.21
0132961027	DEK 5 GS G	F.21
0132961028	DEK 5 GS H	F.21
0132961029	DEK 5 GS I	F.21
0132961030	DEK 5 GS J	F.21
0132961031	DEK 5 GS K	F.21
0132961032	DEK 5 GS L	F.21
0132961033	DEK 5 GS M	F.21
0132961034	DEK 5 GS N	F.21
0132961035	DEK 5 GS O	F.21
0132961036	DEK 5 GS P	F.21
0132961037	DEK 5 GS Q	F.21
0132961038	DEK 5 GS R	F.21
0132961039	DEK 5 GS S	F.21
0132961040	DEK 5 GS T	F.21
0132961041	DEK 5 GS U	F.21
0132961042	DEK 5 GS V	F.21
0132961043	DEK 5 GS W	F.21
0132961044	DEK 5 GS X	F.21
0132961045	DEK 5 GS Y	F.21
0132961046	DEK 5 GS Z	F.21

0133161114	DEK 5 FW U1-PE1	F.21
0133161115	DEK 5 FW U2-PE2	F.21
0133161116	DEK 5 FW U3-PE3	F.21
0133161117	DEK 5 FW U4-PE4	F.21
0133161118	DEK 5 FW U5-PE5	F.21
0133161119	DEK 5 FW U6-PE6	F.21
0133161120	DEK 5 FW U7-PE7	F.21
0133161121	DEK 5 FW U8-PE8	F.21
0133161122	DEK 5 FW U9-PE9	F.21
0133261150	DEK 5 FW X1-Z1	F.21
0133261152	DEK 5 FW X3-Z3	F.21
0133261153	DEK 5 FW X4-Z4	F.21
0133261154	DEK 5 FW X5-Z5	F.21
0133261155	DEK 5 FW X6-Z6	F.21
0133261156	DEK 5 FW X7-Z7	F.21
0133261157	DEK 5 FW X8-Z8	F.21
0133261158	DEK 5 FW X9-Z9	F.21
0133261159	DEK 5 FW X10-Z10	F.21

0133360001	DEK 6 FSZ 1-10	F.22
0133360011	DEK 6 FSZ 11-20	F.22
0133360021	DEK 6 FSZ 21-30	F.22
0133360031	DEK 6 FSZ 31-40	F.22
0133360041	DEK 6 FSZ 41-50	F.22
0133360051	DEK 6 FSZ 51-60	F.22
0133360061	DEK 6 FSZ 61-70	F.22
0133360071	DEK 6 FSZ 71-80	F.22
0133360081	DEK 6 FSZ 81-90	F.22
0133360091	DEK 6 FSZ 91-100	F.22
0134420000	KS 2 0.D2	D.136
0134500000	D2 KS2 TP	D.136
0134700000	TS 15X5 2M/AL/BK	F.9
0136400000	SS M4 D 128A.4	D.48
0137400000	E 14/2A RS	D.48
0137500000	E 14/4A BR	D.48
0138000000	P 14/2 D01 RS SAKS4	D.48
0138100000	P 14/4 D01 BR SAKS4	D.48

014000000

0140200000	STB 16/D7/4/M4 SAK35	D.173
0140320000	KS 4 0.D4	D.136
0140500000	D4 KS4 TP	D.136
0140620000	KS 6 0.D6	D.136
0140800000	D6 KS6 TP	D.136
0141620000	KS 10 0.D10	D.136
0141800000	D10 KS10 TP	D.136
0143200000	ELSB 2 BEZ. 1-2	D.136
0143500000	ELSB 10 BEZ. 1-10	D.136

Order No.	Type	Page
-----------	------	------

015000000

0157261187	DEK 5 GS PE	F.21
0157261202	DEK 5 GS ERDE	F.21
0157261203	DEK 5 GS ERDE IM KREIS	F.21

016000000

0164000000	TSTW 6/M6	F.13
0164400000	SS M3 D 128A.3	D.37
0169300000	TS 32X15 2M/AL/BK	F.9
0169900000	STB 14/D6/4/M3 SAK10	D.173

017000000

0178100000	TSTW 5/M5	F.13
------------	-----------	------

018000000

0180400000	PS 2.3 RT	D.173
0186100000	H2,5/12	F.77
0186500000	H1,5/10	F.77

019000000

0191900000	H6,0/12	F.77
0192700000	G 25/2.00A/F BL	C.65
0192800000	G 25/4.00A/F BR	C.65
0192900000	G 25/6.30A/F GN	C.65
0193100000	G 25/10.0A/M RT	C.65
0194300000	QL 2 SAK6N	D.172
0194400000	QL 3 SAK6N	D.172
0194500000	QL 4 SAK6N	D.172
0197200000	BSTO 28/4 BK	D.137
0197300000	BSTB 28/4 BK U 1-4	D.137
0197400000	BSTO 28/6 BK	D.137
0197500000	BSTB 28/6 BK U 1-6	D.137
0198700000	BSTO 28/12 BK	D.137
0198800000	BSTB 28/12 BK U 1-12	D.137
0199360000	EWK 2	F.12

020000000

0203500000	BSTO 28/2 BK	D.137
0203600000	BSTB 28/2 BK U 1-2	D.137
0203700000	BSTO 28/3 BK	D.137
0206160000	EWK 1	F.12
0207800000	QL 2 SAKS2	D.48
0208000000	QL 4 SAKS2	D.48
0208500000	E 16/10A RT TNDZ	D.48
0208600000	E 16/16A GR TNDZ	D.48
0208700000	E 16/20A BL TNDZ	D.48
0208900000	E 16/25A GE TNDZ	D.48
0208900000	P 16/10 RT SAKS2	D.48
0209000000	P 16/16 GR SAKS2	D.48
0209100000	P 16/20 BL SAKS2	D.48

021000000

0210800000	ADL	D.158
0215700000	STB 8,5/D4/2,3/M2,5 AKZ	D.173

022000000

0221200000	QL 15 SAK6N	D.71
------------	-------------	------

023000000

0235000000	IS 8 DIN 6911	F.63
0235860000	DEK 5 FWZ 1,3,5-19	F.21
0235960000	DEK 5 FWZ 21,23,25-39	F.21
0236060000	DEK 5 FWZ 41,43,45-59	F.21
0236160000	DEK 5 FWZ 2,4,6-20	F.21
0236260000	DEK 5 FWZ 22,24,26-40	F.21
0236360000	DEK 5 FWZ 42,44,46-60	F.21
0236400000	TS 35X15 2M/ST/ZN	F.10
0236500000	TS 35X15/LL 2M/ST/ZN	F.10
0236510000	TS 35X15/LL 1M/ST/ZN	F.10

024000000

0241260000	MK 2/12	D.134
0243520000	MK 3/12	D.134
0243820000	MK 5/2 0.DE	D.136
0244060000	D 2 MKS/2 PA/NA	D.136
0244100000	H4,0/12	F.77
0244220000	MK 4/16	D.136
0245400000	GZ 12,5A/FF	C.65
0245700000	BSTB 28/12/6,35 U 1-12	D.134
0245800000	BSTO 28/12 MK	D.134
0245900000	BSTB 28/12 MK U 1-12	D.134
0248500000	VH 13,5/4,9/3,3 SAK4	D.71
0249000000	VH 12/4,9/3,3 SAK6N	D.71

025000000

0258260000	HP 7 TSK31.5	F.15
0258360000	HP 8 ADP 1	F.15
0258660000	EW 35/SCHA/M3	D.76

Order No.	Type	Page
-----------	------	------

0259800000	SSCH 10X3X1000 MS/BK	F.3
------------	----------------------	-----

026000000

0262100000	BSTO 28/16 MK 4/16	D.135
0262200000	BSTB 28/16 MK U 1-16	D.135
0265800000	G 25/1.00A/M RT	C.65
0266500000	ZB 35/M6X16	F.6
0267100000	BFSC M4X30	F.4
0267200000	STB 25 IH/GE	D.65

027000000

0270100000	TS 35X15/2,3 2M/CU/BK	F.10
0270760000	QS 2/12/4	D.71
0270860000	QS 2/10/4	D.71
0270960000	QS 2/8/4	B.23
0271200000	STB 25 IH/GN	D.65
0271300000	STB 25 IH/VI	D.65
0273820000	MK 3/2	D.134
0273920000	MK 3/3	D.134
0274020000	MK 3/4	D.134
0274120000	MK 3/5	D.134
0274220000	MK 3/6	D.134
0274320000	MK 3/7	D.134
0274420000	MK 3/8	D.134
0274620000	MK 3/10	D.134
0278500000	BSTB 28/12/6,35 0 1-12	D.134

028000000

0280100000	DKSUE NSCH/ESCH	F.3
0280200000	NSCH 1M	F.3
0280300000	ESCH 1 M	F.3
0280600000	STB 8,5/5/2,3/M3 SAK2,5	D.72
0282600000	H0,5/6	F.77
0282700000	H0,75/6	F.77
0282800000	H1,0/10	F.77
0282900000	H1,0/12	F.77
0284100000	SK E16/SAKS2	D.48
0284700000	BSTO 28/8 MK3/8	D.134
0289300000	BSTO 28/4 MK3/4	D.134
0289500000	BSTO 28/6 MK	D.134

029000000

0290000000	BSTB 28/6 MK U 1-6	D.134
0290200000	BSTB 28/8 MK U 1-8	D.134
0292460000	SCHT 5	F.31
0293220000	TS 32X15 2M/CRN	F.9
0293800000	PS 2,0 OR	C.143
0293900000	GZ 10,0A	C.65
0294000000	STR 5 F.SCHT 5	F.31
0294360000	AKZ 4	D.131
0294380000	AKZ 4 BL	D.131
0294420000	AP AKZ4 KRZ	D.158
0294430000	AP AKZ4 KRS	D.158
0294460000	AP AKZ4	D.131
0294480000	AP AKZ4 BL	D.131
0294500000	GZ 2,0A	C.65
0294600000	GZ 5,0A	C.65
0295700000	GZ 3,0A	C.65
0295800000	GZ 7,0A	C.65
0295900000	FKSC M5X8 D9/SW2,5	F.13
0296700000	BFSC M5X8 Schlitz	F.3
0299600000	PS 4 F.STB 4	C.69
0299860000	SH 1	F.4

030000000

0303000000	KISC M3X20,5/10 EK4	D.76
0307300000	QVS 2 SAKT1+2	D.65
0307400000	QVS 4 SAKT1+2	D.70
0309700000	VH 16/5/3,5 SAK10-35	D.63

031000000

0316500000	ZB 4	F.6
0316600000	ZB 16 Z	

Order No.	Type	Page
0400000000		
0401460000	SO SH1	F.4
0407360001	DEK 6,5 FSZ 1-10	F.23
0407360011	DEK 6,5 FSZ 11-20	F.23
0407360021	DEK 6,5 FSZ 21-30	F.23
0407360031	DEK 6,5 FSZ 31-40	F.23
0407360041	DEK 6,5 FSZ 41-50	F.23
0407360051	DEK 6,5 FSZ 51-60	F.23
0407360061	DEK 6,5 FSZ 61-70	F.23
0407360071	DEK 6,5 FSZ 71-80	F.23
0407360081	DEK 6,5 FSZ 81-90	F.23
0407360091	DEK 6,5 FSZ 91-100	F.23
0407900000	IS 6 DIN 6911	F.63
0409500000	H0,5/12 OR	F.66
0409600000	H0,75/12 W	F.66
0409700000	H1,0/12 GE	F.66

Order No.	Type	Page
0430000000		
0430300000	G 20/0,10A/F	C.65
0430400000	G 20/0,20A/F	C.65
0430500000	G 20/0,25A/F	C.65
0430600000	G 20/0,50A/F	C.65
0430700000	G 20/1,00A/F	C.65
0430800000	G 20/1,60A/F	C.65
0430900000	G 20/2,00A/F	C.65
0431000000	G 20/2,50A/F	C.65
0431100000	G 20/3,15A/F	C.65
0431200000	G 20/4,00A/F	C.65
0431300000	G 20/5,00A/F	C.65
0431400000	G 20/6,30A/F	C.65
0439000000	SSCH 10X31000 ST/ZN	F.3
0439000000	G 20/0,63A/F	C.65

Order No.	Type	Page
0440000000		
0444200000	H50/36 OLIV	F.66
0445600000	MEW 1/32	F.12

Order No.	Type	Page
0450000000		
0459500000	ZBE 6	F.6

Order No.	Type	Page
0460000000		
0460660001	DEK 5 FSZ 1-10	F.21
0460660011	DEK 5 FSZ 11-20	F.21
0460660021	DEK 5 FSZ 21-30	F.21
0460660031	DEK 5 FSZ 31-40	F.21
0460660041	DEK 5 FSZ 41-50	F.21
0460660051	DEK 5 FSZ 51-60	F.21
0460660061	DEK 5 FSZ 61-70	F.21
0460660071	DEK 5 FSZ 71-80	F.21
0460660081	DEK 5 FSZ 81-90	F.21
0460660091	DEK 5 FSZ 91-100	F.21
0462900000	H0,75/14 W	F.66
0463000000	H1,0/14 GE	F.66
0463100000	H1,5/14 R	F.66
0468060000	DEK 6,5 NEUTRAL	F.23
0468091686	DEK 6,5 RT NEUTRAL	F.23
0468091687	DEK 6,5 GE NEUTRAL	F.23
0468091688	DEK 6,5 GN NEUTRAL	F.23
0468091689	DEK 6,5 VI NEUTRAL	F.23
0468091690	DEK 6,5 OR NEUTRAL	F.23
0468091691	DEK 6,5 BR NEUTRAL	F.23
0468091692	DEK 6,5 BL NEUTRAL	F.23
0468091694	DEK 6,5 SW NEUTRAL	F.23
0468160001	DEK 6,5 FW 1-50	F.23
0468160051	DEK 6,5 FW 51-100	F.23
0468160101	DEK 6,5 FW 101-150	F.23
0468160151	DEK 6,5 FW 151-200	F.23
0468160201	DEK 6,5 FW 201-250	F.23
0468160251	DEK 6,5 FW 251-300	F.23
0468160301	DEK 6,5 FW 301-350	F.23
0468160351	DEK 6,5 FW 351-400	F.23
0468160401	DEK 6,5 FW 401-450	F.23
0468160451	DEK 6,5 FW 451-500	F.23
0468160501	DEK 6,5 FW 501-550	F.23
0468260001	DEK 6,5 FS 1-50	F.23
0468260051	DEK 6,5 FS 51-100	F.23
0468260101	DEK 6,5 FS 101-150	F.23
0468560000	DEK 6 NEUTRAL	F.23
0468591686	DEK 6 RT NEUTRAL	F.22
0468591687	DEK 6 GE NEUTRAL	F.22
0468591688	DEK 6 GN NEUTRAL	F.22
0468591689	DEK 6 VI NEUTRAL	F.22
0468591690	DEK 6 OR NEUTRAL	F.22
0468591691	DEK 6 BR NEUTRAL	F.22
0468591692	DEK 6 BL NEUTRAL	F.22
0468591694	DEK 6 SW NEUTRAL	F.22
0468660001	DEK 6 FW 1-50	F.22
0468660051	DEK 6 FW 51-100	F.22
0468660101	DEK 6 FW 101-150	F.22
0468660151	DEK 6 FW 151-200	F.22
0468660201	DEK 6 FW 201-250	F.22
0468660251	DEK 6 FW 251-300	F.22
0468660301	DEK 6 FW 301-350	F.22
0468660351	DEK 6 FW 351-400	F.22

Order No.	Type	Page
0468660401	DEK 6 FW 401-450	F.22
0468660451	DEK 6 FW 451-500	F.22
0468660501	DEK 6 FW 501-550	F.22
0468660551	DEK 6 FW 551-600	F.22
0468660601	DEK 6 FW 601-650	F.22
0468660651	DEK 6 FW 651-700	F.22
0468660701	DEK 6 FW 701-750	F.22
0468660751	DEK 6 FW 751-800	F.22
0468660801	DEK 6 FW 801-850	F.22
0468660851	DEK 6 FW 851-900	F.22
0468660901	DEK 6 FW 901-950	F.22
0468660951	DEK 6 FW 951-999	F.22
0468760001	DEK 6 FS 1-50	F.22
0468760051	DEK 6 FS 51-100	F.22
0468760101	DEK 6 FS 101-150	F.22
0468760151	DEK 6 FS 151-200	F.22
0468760201	DEK 6 FS 201-250	F.22
0468760251	DEK 6 FS 251-300	F.22
0468760301	DEK 6 FS 301-350	F.22
0468760351	DEK 6 FS 351-400	F.22
0468760401	DEK 6 FS 401-450	F.22
0468760451	DEK 6 FS 451-500	F.22
0468760501	DEK 6 FS 501-550	F.22
0468760551	DEK 6 FS 551-600	F.22
0468760601	DEK 6 FS 601-650	F.22
0468760651	DEK 6 FS 651-700	F.22
0468760701	DEK 6 FS 701-750	F.22
0468760751	DEK 6 FS 751-800	F.22
0468760801	DEK 6 FS 801-850	F.22
0468760851	DEK 6 FS 851-900	F.22
0468760901	DEK 6 FS 901-950	F.22
0468760951	DEK 6 FS 951-999	F.22

Order No.	Type	Page
0470000000		
0470700000	QL 2 SAK16	D.43
0470800000	QL 3 SAK16	D.43
0470900000	QL 4 SAK16	D.43
0471000000	QL 10 SAK16	D.43
0473360000	DEK 5 NEUTRAL	F.22
0473391686	DEK 5 RT NEUTRAL	F.22
0473391687	DEK 5 GE NEUTRAL	F.22
0473391688	DEK 5 GN NEUTRAL	F.21
0473391689	DEK 5 VI NEUTRAL	F.22
0473391690	DEK 5 OR NEUTRAL	F.22
0473391691	DEK 5 BR NEUTRAL	F.21
0473391692	DEK 5 BL NEUTRAL	F.21
0473391693	DEK 5 SW NEUTRAL	F.22
0473391694	DEK 5 FW 1-50	F.21
0473460051	DEK 5 FW 51-100	F.21
0473460101	DEK 5 FW 101-150	F.21
0473460151	DEK 5 FW 151-200	F.21
0473460201	DEK 5 FW 201-250	F.21
0473460251	DEK 5 FW 251-300	F.21
0473460301	DEK 5 FW 301-350	F.21
0473460351	DEK 5 FW 351-400	F.21
0473460401	DEK 5 FW 401-450	F.21
0473460451	DEK 5 FW 451-500	F.21
0473460501	DEK 5 FW 501-550	F.21
0473460551	DEK 5 FW 551-600	F.21
0473460601	DEK 5 FW 601-650	F.21
0473460651	DEK 5 FW 651-700	F.21
0473460701	DEK 5 FW 701-750	F.21
0473460751	DEK 5 FW 751-800	F.21
0473460801	DEK 5 FW 801-850	F.21
0473460851	DEK 5 FW 851-900	F.21
0473460901	DEK 5 FW 901-950	F.21
0473460951	DEK 5 FW 951-999	F.21
0473560001	DEK 5 FS 1-50	F.21
0473560051	DEK 5 FS 51-100	F.21
0473560101	DEK 5 FS 101-150	F.21
0473560151	DEK 5 FS 151-200	F.21
0473560201	DEK 5 FS 201-250	F.21
0473560251	DEK 5 FS 251-300	F.21
0473560301	DEK 5 FS 301-350	F.21
0473560351	DEK 5 FS 351-400	F.21
0473560401	DEK 5 FS 401-450	F.21
0473560451	DEK 5 FS 451-500	F.21
0473560501	DEK 5 FS 501-550	F.21
0473560551	DEK 5 FS 551-600	F.21
0473560601	DEK 5 FS 601-650	F.21
0473560651	DEK 5 FS 651-700	F.21
0473560701	DEK 5 FS 701-750	F.21
0473560751	DEK 5 FS 751-800	F.21
0473560801	DEK 5 FS 801-850	F.21
0473560851	DEK 5 FS 851-900	F.21
0473560901	DEK 5 FS 901-950	F.21
0473560951	DEK 5 FS 951-999	F.21
0475360000	ZB 4K GE/GN	F.7
0475380000	ZB 4K BL	F.7
0475460000	IK 4 GG ZB4	F.6
0475480000	IK 4 BL ZB4	F.6

Order No.	Type	Page
0480000000		
0485100000	IS 4 DIN 6911	F.63
0485200000	ADP 1/HP1 1M	F.15
0485300000	ADP 2/HP2 1M	F.15

Order No.	Type	Page
0485400000	ADP 3/HP3 1M	F.15
0485560000	HP 1 ADP1	F.15
0485660000	HP 2 ADP2	F.15
0485760000	HP 3 ADP3	F.15
0485860000	HP 4 ADP3	F.15

Order No.	Type	Page
0490000000		
0492500000	H16,0/12	F.77
0494920000	SH 2	F.4
0495660000	MOFU 35	F.14
0498000000	TS 35X15/2,3 2M/ST/ZN	F.10

Order No.	Type	Page
0500000000		
0501800000	SAKS 4/35 DB	D.48
0502100000	SAKS 5/35 DB	D.49
0502610000	ZB 35K SW M6X16	F.7
0502660000	ZB 35K GE/GN M6X16	F.7
0502680000	ZB 35K BL M6X16	F.7
0502780000	IK 35/ZB35 BL	F.6
0502860000	ZB 16K GE/GN	F.7
0502880000	ZB 16K BL	F.7
0502960000	IK 16/ZB16 GG	F.6
0502980000	IK 16/ZB16 BL	F.6
0503500000	MB M3/M5 CRM	F.14
0508401694	STI Waterproof schwarz	F.39

Order No.	Type	Page
0510000000		
0510300000	G 25/0,50A/M WS	C.65
0511420000	TS 15X5 2M/ST/ZN	F.9
0511430000	TSK 35X15 2M PVC/GR	F.11
0511440000	TS 32X15/LL 2M/ST/ZN	F.9
0511450000	TS 35X7,5/LL 2M/ST/ZN	F.10
0511451000	TS 35X7,5/LL 1M/ST/ZN	F.10
0511457000	TS 35X7,5/LL/6 2M/ST/ZN	F.10
0511490000	STR 7 F.SCHT 7	F.31
0511960000	SCHT 7	F.31
0511960001	DEK 6 FWZ 1-10	F.22
0511960011	DEK 6 FWZ 11-20	F.22
0511960021	DEK 6 FWZ 21-30	F.22
0511960031	DEK 6 FWZ 31-40	F.22
0511960041	DEK 6 FWZ 41-50	F.22
0511960051	DEK 6 FWZ 51-60	F.22
0511960061	DEK 6 FWZ 61-70	F.22
0511960071	DEK 6 FWZ 71-80	F.22
0511960081	DEK 6 FWZ 81-90	F.22
0511960091	DEK 6 FWZ 91-100	F.22
0511960101	DEK 6 FWZ 101-110	F.22
0511960111	DEK 6 FWZ 111-120	F.22
0511960121	DEK 6 FWZ 121-130	F.22
0511960131	DEK 6 FWZ 131-140	F.22
0511960141	DEK 6 FWZ 141-150	F.22
0511960151	DEK 6 FWZ 151-160	F.22
0511960161	DEK 6 FWZ 161-170	F.22
0511960171	DEK	

Order No.	Type	Page
0522660123	DEK 5 GW 123	F.21
0522660124	DEK 5 GW 124	F.21
0522660125	DEK 5 GW 125	F.21
0522660126	DEK 5 GW 126	F.21
0522660127	DEK 5 GW 127	F.21
0522660128	DEK 5 GW 128	F.21
0522660129	DEK 5 GW 129	F.21
0522660130	DEK 5 GW 130	F.21
0522660131	DEK 5 GW 131	F.21
0522660132	DEK 5 GW 132	F.21
0522660133	DEK 5 GW 133	F.21
0522660134	DEK 5 GW 134	F.21
0522660135	DEK 5 GW 135	F.21
0522660136	DEK 5 GW 136	F.21
0522660137	DEK 5 GW 137	F.21
0522660138	DEK 5 GW 138	F.21
0522660139	DEK 5 GW 139	F.21
0522660140	DEK 5 GW 140	F.21
0522660141	DEK 5 GW 141	F.21
0522660142	DEK 5 GW 142	F.21
0522660143	DEK 5 GW 143	F.21
0522660144	DEK 5 GW 144	F.21
0522660145	DEK 5 GW 145	F.21
0522660146	DEK 5 GW 146	F.21
0522660147	DEK 5 GW 147	F.21
0522660148	DEK 5 GW 148	F.21
0522660149	DEK 5 GW 149	F.21
0522660150	DEK 5 GW 150	F.21
0522660151	DEK 5 GW 151	F.21
0522660152	DEK 5 GW 152	F.21
0522660153	DEK 5 GW 153	F.21
0522660154	DEK 5 GW 154	F.21
0522660155	DEK 5 GW 155	F.21
0522660156	DEK 5 GW 156	F.21
0522660157	DEK 5 GW 157	F.21
0522660158	DEK 5 GW 158	F.21
0522660159	DEK 5 GW 159	F.21
0522660160	DEK 5 GW 160	F.21
0522660161	DEK 5 GW 161	F.21
0522660162	DEK 5 GW 162	F.22
0522660163	DEK 5 GW 163	F.22
0522660164	DEK 5 GW 164	F.22
0522660165	DEK 5 GW 165	F.22
0522660166	DEK 5 GW 166	F.22
0522660167	DEK 5 GW 167	F.22
0522660168	DEK 5 GW 168	F.22
0522660169	DEK 5 GW 169	F.22
0522660170	DEK 5 GW 170	F.22
0522660171	DEK 5 GW 171	F.22
0522660172	DEK 5 GW 172	F.22
0522660173	DEK 5 GW 173	F.22
0522660174	DEK 5 GW 174	F.22
0522660175	DEK 5 GW 175	F.22
0522660176	DEK 5 GW 176	F.22
0522660177	DEK 5 GW 177	F.22
0522660178	DEK 5 GW 178	F.22
0522660179	DEK 5 GW 179	F.22
0522660180	DEK 5 GW 180	F.22
0522660181	DEK 5 GW 181	F.22
0522660182	DEK 5 GW 182	F.22
0522660183	DEK 5 GW 183	F.22
0522660184	DEK 5 GW 184	F.22
0522660185	DEK 5 GW 185	F.22
0522660186	DEK 5 GW 186	F.22
0522660187	DEK 5 GW 187	F.22
0522660188	DEK 5 GW 188	F.22
0522660189	DEK 5 GW 189	F.22
0522660190	DEK 5 GW 190	F.22
0522660191	DEK 5 GW 191	F.22
0522660192	DEK 5 GW 192	F.22
0522660193	DEK 5 GW 193	F.22
0522660194	DEK 5 GW 194	F.22
0522660195	DEK 5 GW 195	F.22
0522660196	DEK 5 GW 196	F.22
0522660197	DEK 5 GW 197	F.22
0522660198	DEK 5 GW 198	F.22
0522660199	DEK 5 GW 199	F.22
0522660200	DEK 5 GW 200	F.22
0522761021	DEK 5 GW A	F.22
0522761022	DEK 5 GW B	F.22
0522761023	DEK 5 GW C	F.22
0522761024	DEK 5 GW D	F.22
0522761025	DEK 5 GW E	F.22
0522761026	DEK 5 GW F	F.22
0522761027	DEK 5 GW G	F.22
0522761028	DEK 5 GW H	F.22
0522761029	DEK 5 GW I	F.22
0522761030	DEK 5 GW J	F.22
0522761031	DEK 5 GW K	F.22
0522761032	DEK 5 GW L	F.22
0522761033	DEK 5 GW M	F.22
0522761034	DEK 5 GW N	F.22
0522761035	DEK 5 GW O	F.22
0522761036	DEK 5 GW P	F.22
0522761037	DEK 5 GW Q	F.22
0522761038	DEK 5 GW R	F.22
0522761039	DEK 5 GW S	F.22
0522761040	DEK 5 GW T	F.22
0522761041	DEK 5 GW U	F.22

Order No.	Type	Page
0522761042	DEK 5 GW V	F.22
0522761043	DEK 5 GW W	F.22
0522761044	DEK 5 GW X	F.22
0522761045	DEK 5 GW Y	F.22
0522761046	DEK 5 GW Z	F.22
0523060001	DEK 5 FWZ 1-10	F.21
0523060011	DEK 5 FWZ 11-20	F.21
0523060021	DEK 5 FWZ 21-30	F.21
0523060031	DEK 5 FWZ 31-40	F.21
0523060041	DEK 5 FWZ 41-50	F.21
0523060051	DEK 5 FWZ 51-60	F.21
0523060061	DEK 5 FWZ 61-70	F.21
0523060071	DEK 5 FWZ 71-80	F.21
0523060081	DEK 5 FWZ 81-90	F.21
0523060091	DEK 5 FWZ 91-100	F.21
0525000000	GZ 1.0A/F	C.65
0525910000	ZBE 6K SW	F.7
0525980000	ZBE 6K GE/GN	F.7
0525980000	ZBE 6K BL	F.7
0526060000	IK 6 GG ZBE6K	F.6
0526960001	DEK 6 GW 1	F.22
0526960002	DEK 6 GW 2	F.22
0526960003	DEK 6 GW 3	F.22
0526960004	DEK 6 GW 4	F.22
0526960005	DEK 6 GW 5	F.22
0526960006	DEK 6 GW 6	F.22
0526960007	DEK 6 GW 7	F.22
0526960008	DEK 6 GW 8	F.22
0526960009	DEK 6 GW 9	F.22
0526960010	DEK 6 GW 10	F.22
0526960011	DEK 6 GW 11	F.22
0526960012	DEK 6 GW 12	F.22
0526960013	DEK 6 GW 13	F.22
0526960014	DEK 6 GW 14	F.22
0526960015	DEK 6 GW 15	F.22
0526960016	DEK 6 GW 16	F.22
0526960017	DEK 6 GW 17	F.22
0526960018	DEK 6 GW 18	F.22
0526960019	DEK 6 GW 19	F.22
0526960020	DEK 6 GW 20	F.22
0526960021	DEK 6 GW 21	F.22
0526960022	DEK 6 GW 22	F.22
0526960023	DEK 6 GW 23	F.22
0526960024	DEK 6 GW 24	F.22
0526960025	DEK 6 GW 25	F.22
0526960026	DEK 6 GW 26	F.22
0526960027	DEK 6 GW 27	F.22
0526960028	DEK 6 GW 28	F.22
0526960029	DEK 6 GW 29	F.22
0526960030	DEK 6 GW 30	F.22
0526960031	DEK 6 GW 31	F.22
0526960032	DEK 6 GW 32	F.22
0526960033	DEK 6 GW 33	F.22
0526960034	DEK 6 GW 34	F.22
0526960035	DEK 6 GW 35	F.22
0526960036	DEK 6 GW 36	F.22
0526960037	DEK 6 GW 37	F.22
0526960038	DEK 6 GW 38	F.22
0526960039	DEK 6 GW 39	F.22
0526960040	DEK 6 GW 40	F.22
0526960041	DEK 6 GW 41	F.22
0526960042	DEK 6 GW 42	F.22
0526960043	DEK 6 GW 43	F.22
0526960044	DEK 6 GW 44	F.22
0526960045	DEK 6 GW 45	F.22
0526960046	DEK 6 GW 46	F.22
0526960047	DEK 6 GW 47	F.22
0526960048	DEK 6 GW 48	F.22
0526960049	DEK 6 GW 49	F.22
0526960050	DEK 6 GW 50	F.22
0526960051	DEK 6 GW 51	F.22
0526960052	DEK 6 GW 52	F.22
0526960053	DEK 6 GW 53	F.22
0526960054	DEK 6 GW 54	F.22
0526960055	DEK 6 GW 55	F.22
0526960056	DEK 6 GW 56	F.22
0526960057	DEK 6 GW 57	F.22
0526960058	DEK 6 GW 58	F.22
0526960059	DEK 6 GW 59	F.22
0526960060	DEK 6 GW 60	F.22
0526960061	DEK 6 GW 61	F.22
0526960062	DEK 6 GW 62	F.22
0526960063	DEK 6 GW 63	F.22
0526960064	DEK 6 GW 64	F.22
0526960065	DEK 6 GW 65	F.22
0526960066	DEK 6 GW 66	F.22
0526960067	DEK 6 GW 67	F.22
0526960068	DEK 6 GW 68	F.22
0526960069	DEK 6 GW 69	F.22
0526960070	DEK 6 GW 70	F.22
0526960071	DEK 6 GW 71	F.22
0526960072	DEK 6 GW 72	F.22
0526960073	DEK 6 GW 73	F.22
0526960074	DEK 6 GW 74	F.22
0526960075	DEK 6 GW 75	F.22
0526960076	DEK 6 GW 76	F.22
0526960077	DEK 6 GW 77	F.22
0526960078	DEK 6 GW 78	F.22
0526960079	DEK 6 GW 79	F.22

Order No.	Type	Page
0526960080	DEK 6 GW 80	F.22
0526960081	DEK 6 GW 81	F.22
0526960082	DEK 6 GW 82	F.22
0526960083	DEK 6 GW 83	F.22
0526960084	DEK 6 GW 84	F.22
0526960085	DEK 6 GW 85	F.22
0526960086	DEK 6 GW 86	F.22
0526960087	DEK 6 GW 87	F.22
0526960088	DEK 6 GW 88	F.22
0526960089	DEK 6 GW 89	F.22
0526960090	DEK 6 GW 90	F.22
0526960091	DEK 6 GW 91	F.22
0526960092	DEK 6 GW 92	F.22
0526960093	DEK 6 GW 93	F.22
0526960094	DEK 6 GW 94	F.22
0526960095	DEK 6 GW 95	F.23
0526960096	DEK 6 GW 96	F.23
0526960097	DEK 6 GW 97	F.23
0526960098	DEK 6 GW 98	F.23
0526960099	DEK 6 GW 99	F.23
0526960100	DEK 6 GW 100	F.23
0526961000	DEK 6 GW 0	F.22

0530000000

0531760000	SSP 3 SAKT1	D.70
0533500000	H6,0/20 SW	F.66
0533800000	GZ 0.5A/F	C.65
0534200000	H10,0/22 EB	F.66
0537261187	DEK 5 GW PE	F.22
0537261188	DEK 5 GW PEN	F.22
0537261235	DEK 5 GW Mp	F.22

0540000000

0542500000	H0,75/10	F.77
0545300000	QB 58/8/9/WI	D.63
0546000000	ISPF QB58 SW	D.63
0546900000	G 25/0,25A/M GE	C.65

0550000000

0553400000	MB M5/M3 SW	F.14
0556660000	SH 3	F.4
0556700000	ZB 4/6	F.6
0556800000	ZB 16/6	F.6
0558360000	DEK 5 FWZ U,V,W,N,PE	F.21

0560000000

0565460000	ZB 4/6K GE/GN	F.7
0565480000	ZB 4/6K BL	F.7
0565600000	H1,5/24 R	F.66
0565700000	H6,0/28 SW	F.66
0565800000	H10,0/28 EB	F.66
0565900000	H16,0/22 GN	F.66
0566000000	H16,0/28 GN	F.66
0566700000	BEZ-KARTE ADP	F.15
0567300000	PZ 3	F.51
0569660000	ZB 16/6K GE/GN	F.7

0570000000

0571300000	SSCH 6X6X1000 CU/SN	F.3
0576260000	DEK 5 GW	F.21
0576261198	DEK 5 GW +	F.22
0576261199	DEK 5 GW -	F.22
0576261202	DEK 5 GW ERDE	F.22
0576261203	DEK 5 GW ERDE L.KR.	F.22
0576261215	DEK 5 GW W-STROM	F.22
0576291737	DEK 5 GW RT/SW +	F.22
0576291741	DEK 5 GW BL/SW -	F.22

0620000000

0620120000	MK 6/6	D.135
0620220000	MK 6/4	D.135
0620320000	MK 6/3	D.135
0620420000	MK 6/2	D.135
0624720000	BK 2 CRN	D.137
0624920000	BK 3 CRN	D.137
0625120000	BK 4 CRN	D.137
0625220000	BK 6 CRN	D.137
0625320000	BK 12 CRN	D.137

0630000000

0631860000	DEK 6 FWZ R,S,T,N,ERDE	F.22
0631961187	DEK 6 FWZ L1-PE	F.22
0631961203	DEK 6 FWZ L1-ERDE L.KRE	F.22
0632060000	DEK 6,5 FWZ R,S,T,N,ERD	F.23
0632161187	DEK 6,5 FW L1-PE	F.23
0632161203	DEK 6,5 FW L1-ERDE L.KR	F.23
0632560000	DEK 6 FW L.N,PE	F.22
0635100000	H1,5/16 R	F.66
0635960000	KLUBE SH1	F.4
0636800000	FM 5/TS35	F.14
0636900000	FM 6/TS35	F.14

Order No.	Type	Page
-----------	------	------

06

Order No.	Type	Page
1020060000	WDU 2.5 OR	D.181
1020080000	WDU 2.5 BL	D.5
1020090000	WDU 2.5 GN	D.181
1020100000	WDU 4	D.6
1020110000	WDU 4 SW	D.181
1020120000	WDU 4 GE	D.181
1020140000	WDU 4 RT	D.181
1020160000	WDU 4 GN	D.181
1020180000	WDU 4 BL	D.6
1020190000	WDU 4 GE/SW	D.181
1020200000	WDU 6	D.8
1020210000	WDU 6 SW	D.181
1020240000	WDU 6 RT	D.181
1020260000	WDU 6 OR	D.181
1020280000	WDU 6 BL	D.8
1020290000	WDU 6 GN	D.181
1020300000	WDU 10	D.8
1020310000	WDU 10 SW	D.181
1020340000	WDU 10 RT	D.181
1020360000	WDU 10 OR	D.181
1020380000	WDU 10 BL	D.8
1020400000	WDU 16 BL	D.181
1020580000	WDU 35 BL	D.181
1020680000	WDU 35/IK BL	D.181
1020700000	WDU 2.5/10 BEZ	D.182
1020800000	WDU 2.5/10 BEZ/NE	D.182
1020900000	WDU 4/10/BEZ	D.182
1021000000	WDU 4/10	D.182
1021500000	WDK 2.5	D.16
1021560000	WDK 2.5 OR	D.181
1021580000	WDK 2.5 BL	D.16
1021600000	WDK 2.5 F	D.99
1021680000	WDK 2.5 F BL	D.99
1021700000	WDK 2.5 FF	D.99
1021800000	WDU 2.5 F 2X2.8	D.98
1021900000	WDU 2.5 FF 2X2.8	D.98
1022220000	PDU 2.5/4/2X2AN	B.5
1022300000	WDK 2.5V	D.17
1022350000	WDK 2.5V GE	D.181
1022360000	WDK 2.5V OR	D.181
1022380000	WDK 2.5V BL	D.17
1022400000	WDK 2.5 FV	D.99
1022600000	WDK 2.5 2D 2.A	D.119
1023200000	WDK 2.5/D	D.119
1023300000	WDK 2.5 1D A.2	D.118
1023400000	WDK 2.5 1D A.1	D.117
1023500000	WDK 2.5 2D	D.119
1023600000	WDK 2.5 LD RT 24VDC +-	D.120
1023700000	WDU 2.5N	D.5
1023760000	WDU 2.5N OR	D.181
1023780000	WDU 2.5N BL	D.5
1023830000	ZTR 6-2	C.70
1024050000	PRINTJET PRO 115V	F.36
1024100000	WDU 2.5/TC TYP K	D.114
1024140000	PJ PRO TNAW	F.36
1024200000	WDU 2.5/TC TYP T	D.114
1024300000	WDU 2.5/TC TYP J	D.114
1024400000	WDU 2.5/TC TYP SR	D.114
1024500000	WDU 120/150	D.14
1024580000	WDU 120/150 BL	D.14
1024600000	WDU 70/95	D.14
1024680000	WDU 70/95 BL	D.14
1024700000	WDU 2.5/1.5/ZR	D.4
1024780000	WDU 2.5/1.5/ZR BL	D.4
1025680000	DEK 5/30 MC SDR	F.33
1025700000	WDK 2.5/10	D.182
1026600000	WDU 120/150/5	D.182
1026700000	WDU 70/95/3	D.182
1027000000	WDUL 4/10	D.116
1027040000	PJ PRO TNTR INK K	F.36
1027050000	PJ PRO TNTR INK C	F.36
1027060000	PJ PRO TNTR INK M	F.36
1027070000	PJ PRO TNTR INK Y	F.36
1027110000	PJ PRO TINTENSET FARBE	F.36
1027300000	WDUL 4/100	D.116
1027400000	WDUL 4/500	D.116
1027410000	WDK 2.5/BLZ/5.08/ZA V	D.101
1027500000	WDUL 4/1K	D.116
1027550000	ZMAK 2.5 690V	C.34
1027600000	WDUL 4/5K	D.116
1027700000	WDUL 4/10K	D.116
1027800000	WDUL 4/50K	D.116
1027840000	WDL 4 WF10	D.145
1028000000	WDUL 4/500K	D.116
1028300000	WFF 35	D.148
1028380000	WFF 35 BL	D.148
1028400000	WFF 70	D.148
1028480000	WFF 70 BL	D.148
1028500000	WFF 120	D.149
1028580000	WFF 120 BL	D.149
1028600000	WFF 185	D.149
1028680000	WFF 185 BL	D.149
1028700000	WFF 300	D.149
1028800000	WDU 35/ZA	D.10
1028880000	WDU 35/ZA BL	D.10
1028900000	WDU 16/ZA	D.9
1028980000	WDU 16/ZA BL	D.9
1029000000	WDU 35/IK/ZA	D.10
1029100000	WDK 2.5/EX	D.17

Order No.	Type	Page
1029300000	WFF 35/AH	D.148
1029400000	WFF 70/AH	D.148
1029500000	WFF 120/AH	D.149
1029600000	WFF 185/AH	D.149
1029700000	WFF 300/AH	D.149
1029800000	WDL 2.5/NT/L/PE	D.78
1029900000	WDL 2.5/N/L/PE	D.79

1030000000

1030200000	WDL 2.5/L/L/PE	D.79
1030300000	WDL 2.5/L/L	D.78
1030400000	WDL 2.5/L	D.79
1030600000	WDL 2.5/S/NT/L/PE	D.80
1030700000	WDL 2.5/S/N/L/PE	D.81
1031100000	WDL 2.5/S/L/L/PE	D.81
1031200000	WDL 2.5/S/L/L	D.80
1031300000	WDL 2.5/S/L	D.81
1031400000	WDU 1.5/ZZ	D.4
1031480000	WDU 1.5/ZZ BL	D.4
1032300000	WDU 70/95/5/N	D.182
1032400000	WDU 120/150/5 N	D.182
1033300000	WDU 2.5/TC TYP E	D.114
1033700000	WDU 2.5/TC TYP B	D.114
1033800000	WMA 4/5	D.182
1034000000	WMA 4/4	D.182
1034100000	WDL 2.5/2/S/NT/L/PE-L/L	D.182
1034200000	WDL 2.5/3/S/NT/L/PE	D.182
1034400000	WDK 2.5/BLZ/5.08/ZA	D.101
1036000000	WPO 4	D.115
1036100000	WDU 16N	D.9
1036180000	WDU 16N BL	D.9
1036300000	WDK 2.5PE	D.23
1036400000	WDK 2.5DUPE	D.17
1036700000	WDU 4 WS	D.181
1036760000	WDU 4 OR	D.181
1036800000	WDU 2.5 WS	D.181
1037300000	WPE 70/95	D.31
1037700000	WDU 2.5 PA/VI	D.181
1037710000	WDU 2.5 BR	D.181
1037720000	WDU 2.5 GR	D.181
1037800000	WDU 4 BR	D.181
1037810000	WDU 4 BR	D.181
1037820000	WDU 4 PA/VI	D.181
1038650000	DEK 5/6 PLUS MC SDR	F.25
1038790000	WS 8/5 PLUS MC SDR	F.28
1038820000	WS 8/6 PLUS MC SDR	F.29
1039600000	WDU 6 GR	D.181
1039700000	WDU 6 WS	D.181
1039900000	WTR 2.5/ZZ	D.55
1039980000	WTR 2.5/ZZ BL	D.55

1040000000

1040220000	WDU 6 GE	D.181
1040400000	WDU 35N	D.11
1040480000	WDU 35N BL	D.11
1040800000	WDU 2.5N ZDV	D.5
1040880000	WDU 2.5N ZDV BL	D.5
1041100000	WDK 2.5 ZDV	D.16
1041180000	WDK 2.5 ZDV BL	D.16
1041500000	WDU 2.5/TC TYP N	D.114
1041600000	WDK 2.5N	D.18
1041610000	WDK 2.5N V	D.18
1041620000	WDK 2.5N PE	D.24
1041650000	WDK 2.5N DUPE	D.19
1041680000	WDK 2.5N BL	D.18
1041900000	WDK 4N	D.19
1041910000	WDK 4N V	D.19
1041920000	WDK 4N PE	D.26
1041950000	WDK 4N DUPE	D.20
1041960000	WDK 4N OR	D.181
1041980000	WDK 4N BL	D.19
1042400000	WDU 10/ZR	D.9
1042480000	WDU 10/ZR BL	D.9
1042500000	WPE 10/ZR	D.28
1042600000	WDU 4N	D.7
1042680000	WDU 4N BL	D.7
1042700000	WPE 4N	D.25
1045570000	ELS 6/30 MC WS	F.32
1045580000	ELS 6/30 MC GE	F.32
1045620000	ELS 16/40 MC WS	F.31
1045630000	ELS 16/40 MC GE	F.31
1045640000	ELS 7/40 MC WS	F.31
1045650000	ELS 7/40 MC GE	F.31
1045660000	ELS 6/30 MC SDR	F.32
1045690000	ELS 16/40 MC SDR	F.32
1045700000	ELS 7/40 MC SDR	F.32
1045970000	WTR 35 E	D.77
1046320000	WS 10/5 PLUS MC SDR	F.28
1046330000	WS 10/6 PLUS MC SDR	F.29
1046340000	DEK 5/6.5 PLUS MC NE WS	F.25
1046350000	DEK 5/8 PLUS MC NE WS	F.25
1046360000	DEK 5/6.5 PLUS MC SDR	F.25
1046370000	DEK 5/8 PLUS MC SDR	F.25
1046380000	WS 10/5 PLUS MC NE WS	F.28
1046390000	WS 10/6 PLUS MC NE WS	F.28
1049200000	PAP PDU6/10 BL	B.46
1049210000	PAP 2.5/4 BL	B.46

Order No.	Type	Page
1050000000	WAP 2.5-10	D.156
1050010000	WAP 2.5-10 SW	D.156
1050020000	WAP 2.5-10 GE	D.156
1050040000	WAP 2.5-10 RT	D.156
1050050000	WAP 2.5-10 GR	D.156
1050060000	WAP 2.5-10 OR	D.156
1050070000	WAP 2.5-10 BR	D.156
1050080000	WAP 2.5-10 BL	D.156
1050090000	WAP 2.5-10 WS	D.156
1050100000	WAP 16+35 WTW 2.5-10	D.157
1050160000	WAP 16+35 WTW 2.5-10 OR	D.157
1050180000	WAP 16+35 WTW 2.5-10 BL	D.157
1050280000	WHP 2.5-35N/10x3 BL	D.82
1050760000	WGB 5 ABDG.M.GRUPPENBEZ	F.33
1050960000	WGB 8 ABDG.M.GRUPPENBEZ	F.33
1051260000	WTA 5/1	D.175
1051960000	WQV 4/2	D.168
1052060000	WQV 4/10	D.168
1052100000	KISC M3X5	D.172
1052260000	WQV 6/10	D.168
1052290000	PAP 2.5/4/4AN BL	B.46
1052300000	PAP 2.5/4/3AN BL	B.46
1052360000	WQV 6/2	D.168
1052460000	WQV 10/10	D.169
1052560000	WQV 10/2	D.169
1053060000	WQV 35/2	D.10
1053160000	WQV 35/10	D.10
1053260000	WQV 16/2	D.9
1053360000	WQV 16/10	D.9
1053660000	WQV 2.5/2	D.168
1053760000	WQV 2.5/3	D.168
1053860000	WQV 2.5/4	D.168
1053960000	WQV 2.5/5	D.168
1054060000	WQV 2.5/6	D.168
1054160000	WQV 2.5/7	D.168
1054260000	WQV 2.5/8	D.168
1054360000	WQV 2.5/9	D.168
1054460000	WQV 2.5/10	D.168
1054560000	WQV 4/3	D.168
1054660000	WQV 4/4	D.168
1054760000	WQV 6/3	D.168
1054860000	WQV 6/4	D.168
1054960000	WQV 10/3	D.169
1055060000	WQV 10/4	D.169
1055160000	WQV 16/3	D.9
1055260000	WQV 16/4	D.9
1055360000	WQV 35/3	D.10
1055460000	WQV 35/4	D.10
1055960000	WAD 12 M. BL	F.33
1056260000	WAD 12 NEUTRAL	F.33
1056400000	LS 2.8 WDU2.5-10	D.116
1057160000	WQV 4/6	D.168
1057260000	WQV 4/7	D.168
1057860000	WQV 4/5	D.168
1058090000	MCP EP SFC 3	F.39
1058520000	ZSI 2X6/4X2.5 FC	C.63
1058800000	WTW EN	D.159
1059000000	WEW 35/1	F.12
1059100000	WAP WDK2.5	D.157
1059140000	WAP WDK2.5 GN	D.157
1059180000	WAP WDK2.5 BL	D.157
1059310000	ZAP ZSI2X6/4X2.5	C.63
1059660000	WQV 2.5/15	D.168

1060000000

1060000000	WAP WDU2.5N/4N	D.158
1060060000	WAP WDU2.5N/4N OR	D.158
1060080000	WAP WDU2.5N/4N BL	D.158
1060090000	WAP WDU2.5N/4N GE	D.158
1060100000	WQB-PEN 35	D.29
1060200000	WQB-PEN 16	D.28
1060220000	WDU 35/ZA OR	D.181
1060300000	WQB-PEN 10	D.180
1061200000	WEW 35/2	F.5
1061210000	WEW 35/2 SW	F.5
1062660000	WQV 6/5	D.168
1062670000	WQV 6/6	D.168
1062680000	WQV 6/7	D.71
1062860000	WAD 27 M. BL	F.33
1062960000	WAD 27 NEUTRAL	F.33
1063300000	WQV 120/2	D.14
1063400000	WQV 120/3	D.14
1063500000	WQV 70/95/2	D.14
1063600000	WQV 70/95/3	D.14
1063900000	WQV 16-2.5	D.161
1064100000	WQV 35-2.5	D.161
1064460000	WAH 35	D.148
1064560000	WAH 70 BE	D.148
1064660000	WAH 120	D.149
1064760000	WAH 185/300 BE	D.149
1064900000	WQL 2 WFF35	D.148
1065000000	WQL 2 WFF70	D.148

Order No.	Type	Page
-----------	------	------

111000000

1112130000	WAP WDK2.5/BLZ/O.ZA LG	D.157
1112910000	WAD 5 MC NE WS	F.33
1112920000	WAD 5 MC NE GE	F.33
1112930000	WAD 5 MC SDR	F.33
1112940000	WAD 8 MC NE WS	F.33
1112950000	WAD 8 MC NE GE	F.33
1112970000	WAD 8 MC SDR	F.33
1116710000	PS_ZOV_SET	C.144
1119030000	ERME 10° SPX 4	F.48
1119040000	ERME 16° SPX 4	F.48
1119700000	ZDK 4-2/2AN	C.31
1119790000	WSI 6/2/LD 250AC LLC	D.43
1119800000	WSI 6/2/LD 10-36V LLC	D.43
1119810000	WSI 6/2/LD 30-70V LLC	D.43
1119820000	WSI 6/2/LD 60-150V LLC	D.43
1119830000	WSI 6/LD 30-70V LLC	D.42
1119840000	WSI 6/LD 10-36V LLC	D.42
1119850000	WSI 6/LD 60-150V LLC	D.42
1119870000	WSI 6/LD 250AC LLC	D.42

112000000

1120450000	WAD 5 MC B GE/SW	F.33
1120470000	WAD 8 MC B GE/SW	F.33
1121740000	PS_ZOV	C.144
1128540000	SDIS 2.5-6.5/PZ/1/2	F.55

113000000

1131740000	ZLDL 2.5-2N PE	C.25
1131750000	ZLDL 2.5-2N/PE/L/L	C.25
1131760000	ZLDL 2.5-2N/PE/L/N	C.25
1137530000	VKSW	F.45
1137780000	WSI 25/1 10X38/LED 1KV	D.47
1137790000	WSI 25/1 10x38 1KV	D.47
1139400000	MCP BASIC	F.38
1139570000	PPE 16S	B.27
1139580000	PDU 16S	B.26
1139880000	MCP AP BASIC	F.39
1139890000	MCP TP-KDF BASIC	F.39
1139910000	PAP PDU16S	B.26

114000000

1142970000	WAD WMF2.5	D.112
1142980000	WBB WMF2.5 BLZ	D.112
1142990000	AP WMF2.5	D.112
1143000000	WMF 2.5 DI BLZ	D.109
1143010000	WMF 2.5 DI BLZ PE	D.110
1143020000	WMF 2.5 DI	D.106
1143030000	WMF 2.5 DI PE	D.107
1143050000	WMF 2.5 BLZ	D.109
1143070000	WMF 2.5	D.106

115000000

1157830000	KT 22	F.42
------------	-------	------

116000000

1161690000	WTL 6 SL	D.90
1162600000	WEW 35/1 SW	F.5
1162610000	ZEW 35/2 SW	F.12
1162820000	WMF 2.5 FU BLZ PE SW	D.111
1162830000	WMF 2.5 FU BLZ PE 10-36V SW	D.111
1162840000	WMF 2.5 FU BLZ PE 30-70V SW	D.111
1162850000	WMF 2.5 FU BLZ PE 60-150V SW	D.111
1162860000	WMF 2.5 FU BLZ PE 100-250V SW	D.111
1162920000	WMF 2.5 FU SW	D.108
1162930000	WMF 2.5 FU 10-36V SW	D.108
1162940000	WMF 2.5 FU 30-70V SW	D.108
1162950000	WMF 2.5 FU 60-150V SW	D.108
1162960000	WMF 2.5 FU 100-250V SW	D.108
1162980000	WMF 2.5 FU BLZ SW	D.111
1162990000	WMF 2.5 FU BLZ 10-36V SW	D.111
1163000000	WMF 2.5 FU BLZ 30-70V SW	D.111
1163010000	WMF 2.5 FU BLZ 60-150V SW	D.111
1163020000	WMF 2.5 FU BLZ 100-250V SW	D.111
1163040000	WMF 2.5 FU PE SW	D.108
1163050000	WMF 2.5 FU PE 10-36V SW	D.108
1163060000	WMF 2.5 FU PE 30-70V SW	D.108
1163070000	WMF 2.5 FU PE 60-150V SW	D.108
1163080000	WMF 2.5 FU PE 100-250V SW	D.108
1165130000	PDU 6/10 4AN BL	B.6
1165140000	PSI 6/10 SW	B.16
1165320000	PAP PTL/PSI 6/10	B.46
1165330000	PAP PTL/PSI 6/10 SW	B.46
1167440000	IL WMF2.5 BLZ OR	D.112
1167630000	FUCR SW	D.112
1167640000	FUCR 10-36V SW	D.112
1167650000	FUCR 30-70V SW	D.112
1167670000	FUCR 60-150V SW	D.112
1167680000	FUCR 100-250V SW	D.112
1167850000	KLBUE 4-13.5 CPF16	E.13

Order No.	Type	Page
-----------	------	------

117000000

1173540000	BZT PRV16 SW 35X15	B.40
1173550000	BZT PRV16 SW 35X7.5	B.40
1173570000	BZT PRV8 SW 35X15	B.39
1173580000	BZT PRV8 SW 35X7.5	B.39
1173590000	BZT PRV4 SW 35X15	B.38
1173600000	BZT PRV4 SW 35X7.5	B.38
1173620000	PRV 16 SW 35X15 RT/WS	B.40
1173630000	TW PRV16	B.40
1173650000	PRV 16 SW 35X15 WS/RT	B.40
1173670000	TW PRV8	B.39
1173680000	PRV 16 SW 35X7.5 RT/WS	B.40
1173700000	TW PRV4	B.38
1173710000	PRV 16 SW 35X7.5 WS/RT	B.40
1173720000	PAP PRV/PPV8 SW	B.39
1173740000	PRV 8 SW 35X15 RT/WS	B.39
1173750000	PAP PRV/PPV4 SW	B.38
1173780000	PRV 8 SW 35X15 WS/RT	B.39
1173790000	PRV 8 SW 35X7.5 RT/WS	B.39
1173800000	PRV 8 SW 35X7.5 WS/RT	B.39
1173810000	PRV 4 SW 35X15 RT	B.38
1173820000	PRV 4 SW 35X15 WS	B.38
1173830000	PRV 4 SW 35X7.5 RT	B.38
1173840000	PRV 4 SW 35X7.5 WS	B.38
1173850000	PPV 8 GR 35X15 DGR	B.41
1173870000	PPV 8 GR 35X15 DGR	B.41
1173880000	PPV 4 GR 35X15 DGR	B.41
1173890000	PPV 4 GR 35X7.5 DGR	B.41
1173900000	PRV 8 BL 35X15 WS/RT	B.39
1173910000	PRV 8 BL 35X7.5 WS/RT	B.39
1173920000	PRV 4 BL 35X15 WS	B.38
1173930000	PRV 4 BL 35X7.5 WS	B.38

118000000

1186630000	WDU 50N IR	D.12
1186720000	WAP WDK10	D.21
1186730000	WAP WDK10 BL	D.21
1186740000	WDK 10	D.21
1186750000	WDK 10 BL	D.21
1186770000	WDK 10 V	D.21
1186780000	WDK 10 V BL	D.21

120000000

1208920000	ZVLD 2.5	C.26
------------	----------	------

121000000

1210390000	ZTA ZVLD	C.26
1210410000	ZAP ZVLD 2.5	C.26
1211450000	PAP PRV/PPV4 GR	B.38
1211460000	PAP PRV/PPV8 GR	B.39
1216230000	HBT 6,0 - 4,6 GE	B.86

122000000

1221340000	PMAX 4	B.10
1221350000	PMAX 4 800V	B.10
1221360000	PAP PMAX 4	B.10
1224870000	FUSE 1KV DC 2A 10/38	D.47
1224880000	FUSE 1KV DC 4A 10/38	D.47
1224890000	FUSE 1KV DC 6A 10/38	D.47
1224900000	FUSE 1KV DC 8A 10/38	D.47
1224910000	FUSE 1KV DC 10A 10/38	D.47
1224920000	FUSE 1KV DC 12A 10/38	D.47
1224930000	FUSE 1KV DC 16A 10/38	D.47
1224950000	FUSE 1KV DC 20A 10/38	D.47
1227850000	ZEW 35/2 GR	F.12
1227890000	WEW 35/1 GR	F.5
1230050000	TW PRV4 1-4	B.38
1230060000	TW PRV4 0-3	B.38
1230070000	TW PRV4 A-D	B.38
1230080000	TW PRV8 1-8	B.39
1230090000	TW PRV8 0-7	B.39
1230110000	TW PRV8 A-H	B.39
1230120000	TW PRV16 1-16	B.40
1230130000	TW PRV16 0-15	B.40
1230140000	TW PRV16 A-P	B.40
1233330000	HBT 2,5 - 4,6 BL	B.86
1233340000	HBT 1,5 - 4,6 RT	B.86
1238040000	ZEW 35 GR	F.12
1238880000	WAP WTL6 SL 4-6	D.90
1238920000	WTD 6 SL 0.5TB	D.68
1238930000	WTL 6 SL 0.5TB	D.68

124000000

1246990000	SMSE WSH 135/60 MT	E.9
1247290000	WDK 2.5/TR-DU	D.60
1247310000	WDK 2.5/TR-DU STB	D.60
1247420000	WDK 2.5/TR-DU PE	D.61
1247430000	WDK 2.5/TR-DU PE STB	D.61

Order No.	Type	Page
-----------	------	------

125000000

1252490000	KLBUE 15-32 FM4	E.12
1252510000	KLBUE 10-20 FM4	E.12
1252520000	KLBUE 4-13.5 FM4	E.12
1252530000	KLBUE 3-8 FM4	E.12
1252540000	KLBUE 15-32 CPF16	E.13
1252550000	KLBUE 10-20 CPF16	E.13
1255010000	GWHUE M3 WTL6	D.69
1259120000	ZDT 2.5/8AN/4	C.90

126000000

1261300000	ZB 10 F.10X3/10X5/10X10	F.6
1265990000	ZSI 2X6/4X2.5	C.64
1267900000	PRV 16 BL 35X15 RT/WS	B.40
1267800000	PRV 16 BL 35X15 WS/RT	B.40
1267810000	PRV 16 BL 35X7.5 RT/WS	B.40
1267820000	PRV 16 BL 35X7.5 WS/RT	B.40
1267830000	PRV 8 BL 35X15 RT/WS	B.39
1267840000	PRV 8 BL 35X7.5 RT/WS	B.39
1267870000	PPV 8 BL 35X15 DGR	B.41
1267880000	PPV 8 BL 35X7.5 DGR	B.41
1267890000	PRV 4 BL 35X15 RT	B.38
1267900000	PRV 4 BL 35X7.5 RT	B.38
1267910000	PPV 4 BL 35X15 DGR	B.41
1267920000	PPV 4 BL 35X7.5 DGR	B.41
1267930000	BZT PRV16 BL 35X15	B.40
1267940000	BZT PRV16 BL 35X7.5	B.40
1267950000	BZT PRV8 BL 35X15	B.39
1267970000	BZT PRV8 BL 35X7.5	B.39
1267980000	BZT PRV4 BL 35X15	B.38
1267990000	BZT PRV4 BL 35X7.5	B.38
1268000000	PAP PRV/PPV8 BL	B.39
1268010000	PAP PRV/PPV4 BL	B.38
1269050000	EW 35 DB	F.12
1269060000	SCHT 14/6	F.32
1269070000	ZST 1	D.178

127000000

1270040000	WMF 2.5 BL	D.106
1270070000	WMF 2.5 DI BL	D.106
1270080000	WMF 2.5 DI PE BL	D.107
1270310000	TSLD C	F.45
1271870000	ZTA ZVLD/ZA	C.26
1274660000	SDI SL 0,6X3,5X100	F.56
1274670000	SDI SL 0,8X4,0X100	F.56
1274680000	SDI SL 1,0X5,5X125	F.56
1274690000	SDI SL 1,2X6,5X150	F.56
1274710000	SDIK SL PH1	F.56
1274720000	SDIK SL PH2	F.56
1274730000	SDIK SL PZ1	F.56
1274740000	SDIK SL PZ2	F.56
1274750000	SDIS SL 3,5-6,5/PH/1/2	F.56
1276960001	DEK 8 FWZ 1-10	F.23
1276960011	DEK 8 FWZ 11-20	F.23
1276960021	DEK 8 FWZ 21-30	F.23
1276960031	DEK 8 FWZ 31-40	F.23
1276960041	DEK 8 FWZ 41-50	F.23
1276960051	DEK 8 FWZ 51-60	F.23
1276960061	DEK 8 FWZ 61-70	F.23
1276960071	DEK 8 FWZ 71-80	F.23
1276960081	DEK 8 FWZ 81-90	F.23
1276960091	DEK 8 FWZ 91-100	F.23
1276960101	DEK 8 FWZ 101-110	F.23
1276960111	DEK 8 FWZ 111-120	F.23
1276960121	DEK 8 FWZ 121-130	F.23
1276960131	DEK 8 FWZ 131-140	F.23
1276960141	DEK 8 FWZ 141-150	F.23
1277060000	DEK 8 NEUTRAL	F.23
1277091686	DEK 8 RT NEUTRAL	F.23
1277091687	DEK 8 GN NEUTRAL	F.23
1277091688	DEK 8 GE NEUTRAL	F.23
1277091689	DEK 8 VI NEUTRAL	F.23
1277091690	DEK 8 OR NEUTRAL	F.23
1278460000	SCHT 9/4	F.32
1278730000	ETA 1170 21 3A	C.63
1278740000	ETA 1170 21 4A	C.63
1278750000	ETA 1170 21 5A	C.63
1278760000	ETA 1170 21 6A	C.63
1278770000	ETA 1170 21 7.5A	C.63
1278780000	ETA 1170 21 8A	C.63
1278790000	ETA 1170 21 10A	C.63
1278810000	ETA 1170 21 15A	C.63
1278820000	ETA 1170 21 20A	C.63
1278830000	ETA 1170 21 25A	C.63
1278840000	ETA 1180 01 0.1A	C.64
1278850000	ETA 1180 01 0.2A	C.64
1278860000	ETA 1180 01 0.25A	C.64
1278870000	ETA 1180 01 0.3A	C.64
1278880000	ETA 1180 01 0.4A	C.64
1278910000	ETA 1180 01 0.5A	C.64
1278920000	ETA 1180 01 0.6A	C.64
1278930		

Order No.	Type	Page
-----------	------	------

154000000

1545710000	BLZ/SL KO SW	D.100
------------	--------------	-------

156000000

1563900000	WD 1 25 K KARTE A 6 ST	D.151
------------	------------------------	-------

157000000

1572000000	DEK 5 FWZ 1-9	F.21
1573200000	WAP WDU1.5/BLZ/ZA	D.100
1577330000	WAP WDU1.5/BLZ	D.100
1577340000	WDU 1.5/BLZ 5.08	D.100
1577400000	WAD WDU1.5/BLZ/BLA	D.100
1577570000	WQV 2.5/20	D.168
1577600000	WQV 2.5/32	D.168
1578950000	WQB A/2	D.172
1578960000	WQB A/3	D.172
1578970000	WQB A/4	D.172
1578990000	WQB A/10	D.172
1579000000	WQB A/24	D.172
1579010000	WQB B/2	D.172
1579020000	WQB B/3	D.172
1579030000	WQB B/4	D.172
1579050000	WQB B/10	D.172
1579060000	WQB B/24	D.172

159000000

1592810000	KLBU 4-13.5	E.6
------------	-------------	-----

160000000

1600490000	KLBU 3-8	E.6
1600490000	KLBU 10-20	E.6
1604200000	SSP WTL6/2	D.67
1604270000	WKS 1/2	D.67
1604280000	WKB 1/2	D.71
1604290000	WKS 1/3	D.71
1604300000	WKB 1/3	D.71
1604310000	WKS 1/4	D.71
1604320000	WKB 1/4	D.71
1604330000	WKB 1/10	D.71
1607710000	ESD 5 DIN A4 WEISS BOG.	F.31
1607720000	ESD 7 A4-BOGEN WEISS	F.31
1608510000	ZDU 2.5	C.6
1608520000	ZDU 2.5 BL	C.6
1608540000	ZDU 2.5/3AN	C.6
1608550000	ZDU 2.5/3AN BL	C.6
1608570000	ZDU 2.5/4AN	C.7
1608580000	ZDU 2.5/4AN BL	C.7
1608600000	ZDU 2.5/2X2AN	C.7
1608610000	ZDU 2.5/2X2AN BL	C.7
1608620000	ZDU 6	C.9
1608630000	ZDU 6 BL	C.9
1608640000	ZPE 2.5	C.38
1608650000	ZPE 2.5/3AN	C.37
1608660000	ZPE 2.5/4AN	C.38
1608670000	ZPE 6	C.40
1608740000	ZAP/TW 1	C.130
1608750000	ZAP/TW 1 BL	C.130
1608760000	ZAP/TW 1 OR	C.130
1608770000	ZAP/TW 2 DB	C.130
1608780000	ZAP/TW 2 BL	C.6
1608790000	ZAP/TW 2 OR	C.130
1608800000	ZAP/TW 3	C.130
1608810000	ZAP/TW 3 BL	C.7
1608820000	ZAP/TW 3 OR	C.130
1608830000	ZAP/TW 5	C.131
1608840000	ZAP/TW 5 BL	C.9
1608850000	ZAP/TW 5 OR	C.131
1608860000	ZQV 2.5/2	C.140
1608870000	ZQV 2.5/3	C.140
1608880000	ZQV 2.5/4	C.140
1608890000	ZQV 2.5/5	B.49
1608900000	ZQV 2.5/6	B.49
1608910000	ZQV 2.5/7	B.49
1608920000	ZQV 2.5/8	B.49
1608930000	ZQV 2.5/9	B.49
1608940000	ZQV 2.5/10	C.140
1608950000	ZQV 4/2 GE	C.140
1608960000	ZQV 4/3 GE	C.140
1608970000	ZQV 4/4 GE	C.140
1608980000	ZQV 4/5 GE	C.140
1608990000	ZQV 4/6 GE	C.140
1609000000	ZQV 4/7 GE	C.140
1609010000	ZQV 4/8 GE	C.140
1609020000	ZQV 4/9 GE	C.140
1609030000	ZQV 4/10 GE	C.140
1609040000	ZTA 1	C.142
1609050000	ZTA 1/ZA	C.142
1609060000	ZTA 2 ZDU4	C.142
1609070000	ZTA 2/ZA ZDU4	C.142
1609080000	ZAD 2/4	C.147
1609110000	ZAD 1/4	C.146
1609120000	ZAD 3/4	C.147
1609801044	DEK 5/5 MC-10 NEUT. WS	F.25
1609801686	DEK 5/5 MC-10 NEUT. RT	F.25

Order No.	Type	Page
-----------	------	------

1609801687	DEK 5/5 MC-10 NEUT. GE	F.25
1609801688	DEK 5/5 MC-10 NEUT. GN	F.25
1609801691	DEK 5/5 MC-10 NEUT. GR	F.25
1609801693	DEK 5/5 MC-10 NEUT. BL	F.25
1609810000	DEK 5/5 MC BEDRUCKT	F.25
1609820000	DEK 5/6 MC NEUTRAL	F.25
1609830000	DEK 5/6 MC BEDRUCKT	F.25
1609840000	DEK 5/6,5 MC NEUTRAL	F.25
1609850000	DEK 5/6,5 MC BEDRUCKT	F.25
1609860000	WS 12/5 MC NEUTRAL	F.28
1609870000	WS 12/5 MC BEDRUCKT	F.28
1609880000	WS 15/5 MC NEUTRAL	F.28
1609890000	WS 15/5 MC BEDRUCKT	F.28
1609900000	WS 12/6 MC NEUTRAL	F.28
1609910000	WS 12/6 MC BEDRUCKT	F.29
1609920000	WS 12/6,5 MC NEUTRAL	F.29
1609930000	WS 12/6,5 MC BEDRUCKT	F.29

161000000

1610000000	ZS 10/5 MC NEUTRAL	F.29
1610010000	ZS 10/5 MC BEDRUCKT	F.29
1610020000	ZS 12/6 MC NEUTRAL	F.29
1610030000	ZS 12/6 BEDRUCKT	F.29
1610840000	ZAP TNHE/ZSI2.5	C.54
1611930000	ZGB 30	F.34
1614280000	ZRH 2.5/3	C.148
1614290000	ZRH 2.5/2 GR/V0	C.148
1614300000	ZRH 2.5/1 WS	C.148
1616400000	ZSI 2.5	C.54
1616410000	ZSI 2.5/LD 250AC	C.55
1616420000	ZSI 2.5/LD 120AC	C.55
1616430000	ZSI 2.5/LD 60AC	C.55
1616440000	ZSI 2.5/LD 28AC	C.55
1616460000	ZSI 2.5/2 500AC	C.56
1616470000	ZSI 2.5/2/LD 28AC	C.57
1616480000	ZSI 2.5/2/LD 60AC	C.57
1616490000	ZSI 2.5/2/LD 120AC	C.57
1616500000	ZSI 2.5/2/LD 250AC	C.57

162000000

1627850000	ZQV 6/2 GE	C.141
1627860000	ZQV 6/3 GE	C.141
1627870000	ZQV 6/4 GE	C.141

163000000

1631350000	ESD 5 DIN A4 GELB BOG.	F.31
1631750000	WTD 6/1 RT	D.181
1631760000	WTD 6/1 GE	D.181
1631920000	ESD 5 S DIN A4-BOGEN	F.31
1631930000	SCHT 5 S	F.31
1631940000	STR 5 S F.SCHT 5 S	F.31
1632050000	ZDU 4	C.8
1632060000	ZDU 4 BL	C.8
1632080000	ZPE 4	C.38
1632090000	ZAP/TW 4	C.131
1632100000	ZAP/TW 4 BL	C.8
1632110000	ZAP/TW 4 OR	C.131
1632130000	ZRH 1.5N/2	C.148
1632140000	ZRH 1.5N/1	C.148
1632290000	WTA 1 WDU1.5	D.174
1632300000	WTA 1/ZA WDU1.5	D.174
1632320000	WTA 2 WDU2.5-10	D.174
1632330000	WTA 2/ZA WDU2.5-10	D.174
1632340000	WTA 2/10 WDU2.5/10	D.174
1632350000	WTA 3 WDU4	D.174
1632360000	WTA 3/ZA WDU4	D.6
1632380000	WTA 6 WTR2.5	D.174
1632390000	WTA 6/ZA WTR2.5	D.174
1633200000	ZDS 2.5/2	C.141
1633210000	ZDS 2.5/3	C.141
1633220000	ZDS 2.5/4	C.141
1633230000	ZDS 2.5/5	C.141
1633280000	VQB 1.5/50 BL	D.96
1633290000	VQB 1.5/50 RT	D.96
1634780000	ESD 7 A4-BOGEN GELB	F.31
1635000000	WS 10/5 MC NEUTRAL	F.28
1635010000	WS 10/5 MC BEDRUCKT	F.28
1635120000	VQB 1.5/50 SW	D.96
1636510000	ESO 15 BOGEN DIN A4	F.34
1636520000	STR 15 F. ZGB 15	F.34
1636530000	ZGB 15	D.94
1636560000	WQV 16N/2	F.39
1636570000	WQV 16N/3	D.9
1636580000	WQV 16N/4	D.9
1636640000	ZRH 4/1 WS	C.148
1636650000	ZRH 4/2	C.148
1636780000	ZDU 2.5 OR	C.152
1636790000	ZDU 2.5/3AN OR	C.152
1636800000	ZDU 2.5/4AN OR	C.152
1636810000	ZDU 2.5/2X2AN OR	C.152
1636820000	ZDU 6 OR	C.153
1636830000	ZDU 4 OR	C.153

164000000

1640740000	WS 8/5 MC NEUTRAL	F.28
------------	-------------------	------

Order No.	Type	Page
-----------	------	------

1640750000	WS 8/5 MC BEDRUCKT	F.28
1646630000	ZS 15/5 MC NEUTRAL	F.29
1646640000	ZS 15/5 MC BEDRUCKT	F.29
1646690000	ZZA 2.5	C.149
1649300000	ZVL 1.5	C.111
1649350000	ZZA 2.5/ZA	C.149
1649540000	ZAP/TW ZIA 1.5/3L	C.110
1649550000	ZAP/TW ZIA 1.5/4L	C.111

165000000

1650210000	WTA 7 WS16	D.174
1650340000	ZDU 2.5/2X2AN/D+	C.121
1650350000	ZDU 2.5/2X2AN/D-	C.121
1650360000	ZVL 1.5 BL	C.111
1650370000	ZVL 1.5 BR	C.111
1650670000	ZBW 2	C.147
1650680000	ZBW 3	C.147
1650690000	ZBW 4	C.147
1650700000	ZBW-6	C.147
1651970000	ZVL 1.5/PE GN/GE BED	C.111
1651980000	ZIA 1.5/3L-1S	C.110
1651990000	ZIA 1.5/3L-1S/LD-RT	C.110
1652000000	ZIA 1.5/3L-PE	C.110
1652010000	ZIA 1.5/4L-1S	C.111
1652020000	ZIA 1.5/4L-1S/LD	C.111
1652030000	ZIA 1.5/4L-PE	C.111
1653340001	DEK 8 FW 1-50 TAMPOPR.	F.23
1653340005	DEK 8 FS 1-100 TAMPOPR.	F.23
1653350001	DEK 8 FS 1-50 TAMPOPR.	F.23
1654050000	ZTA 3 ZDU6	C.142

166000000

1669620000	ZBW 1	C.147
1669630000	ZBWW	C.147

167000000

1670360000	QVSK 2 SAKT1	D.70
1670370000	ESO 5 POLY WEISS A4-BOG.	F.31
1670380000	ESO 5 POLY GELB A4-BOG.	F.31
1670390000	ESO 7 POLY WEISS A4-BOG.	F.31
1670400000	ESO 7 POLY GELB A4-BOG.	F.31
1674300000	ZDK 2.5	C.22
1674650000	ZAP/TW ZPV1.5	C.110
1674730000	ZAP/TW ZDK2.5	C.130
1675350000	KLBU 2X1.5	E.6
1676610000	BZT ZVL2.5	C.111
1676620000	BZT ZVL1.5/0,ZA	C.111
1676630000	ZPV 1.5	C.110
1676640000	ZDUS	C.149
1677120000	ZQB 2.5-2	C.140
1678630000	ZDK 2.5 BL	C.22
1678680000	ZST	C.151
1678800000	ZRH 1.5H/2	C.148
1678810000	ZRH 1.5H/1	C.148

168000000

1683260000	ZDU 2.5 RT	C.152
1683270000	ZDU 2.5 GE	C.152
1683280000	ZDU 2.5 GN	C.152
1683290000	ZDU 2.5 VI	C.152
1683300000	ZDU 2.5 BR	C.152
1683310000	ZDU 2.5 GR	C.152
1683320000	ZDU 2.5 WS	C.152
1683330000	ZDU 2.5 SW	C.152
1683340000	ZDU 2.5/3AN RT	C.152
1683350000	ZDU 2.5/3AN GE	C.152
1683360000	ZDU 2.5/3AN GN	C.152
1683390000	ZDU 2.5/3AN GR	C.152
1683400000	ZDU 2.5/3AN WS	C.152
1683410000	ZDU 2.5/3AN SW	C.152
1683420000	ZDU 2.5/4AN RT	C.152
1683430000	ZDU 2.5/4AN GE	C.152
1683440000	ZDU 2.5/4AN GN	C.152
1683460000	ZDU 2.5/4AN BR	C.152
1683470000	ZDU 2.5/4AN GR	C.152
1683480000	ZDU 2.5/4AN WS	C.152
1683490000	ZDU 2.5/4AN SW	C.152
1683580000	ZDU 4 RT	C.153
1683590000	ZDU 4 GE	C.153
1683620000	ZDU 4 BR	C.153
1683630000	ZDU 4 GR	C.153
1683640000	ZDU 4 WS	C.153
1683650000	ZDU 4 SW	C.153
1683660000	ZAP/TW 1 RT	C.130
1683680000	ZAP/TW 1 GN	C.130
1683710000	ZAP/TW 1 GR	C.130
1683730000	ZAP/TW 1 SW	C.130
1683740000	ZAP/TW 2 RT	C.130
1683760000	ZAP/TW 2 GN	C.130
1683820000	ZAP/TW 3 RT	C.130
1683840000	ZAP/TW 3 GR	C.130
1683870000	ZAP/TW 3 GN	C.130
1683880000	ZAP/TW 3 WS	C.130
1683890000	ZAP/TW 3 SW	C.130

Order No.	Type	Page
-----------	------	------

Order No.	Type	Page
1716300000	KLBU 15-32	E.6
1717740000	WPE 35N	D.29
1717900000	ZDV 2.5N/2 RT	D.165
1717910000	ZDV 2.5N/3 RT	D.165
1717920000	ZDV 2.5N/4 RT	D.165
1717930000	ZDV 2.5N/5 RT	D.165
1717940000	ZDV 2.5N/6 RT	D.165
1717950000	ZDV 2.5N/7 RT	D.165
1717960000	ZDV 2.5N/8 RT	D.165
1717970000	ZDV 2.5N/9 RT	D.165
1717980000	ZDV 2.5N/10 RT	D.165
1717990000	ZDV 2.5N/2 BL	D.165
1718000000	ZDV 2.5N/3 BL	D.165
1718010000	ZDV 2.5N/4 BL	D.165
1718020000	ZDV 2.5N/5 BL	D.165
1718030000	ZDV 2.5N/6 BL	D.165
1718040000	ZDV 2.5N/7 BL	D.165
1718050000	ZDV 2.5N/8 BL	D.165
1718060000	ZDV 2.5N/9 BL	D.165
1718070000	ZDV 2.5N/10 BL	D.165
1718080000	ZDV 2.5N/2 SW	D.165
1718090000	ZDV 2.5N/3 SW	D.165
1718100000	ZDV 2.5N/4 SW	D.165
1718110000	ZDV 2.5N/5 SW	D.165
1718120000	ZDV 2.5N/6 SW	D.165
1718130000	ZDV 2.5N/7 SW	D.165
1718140000	ZDV 2.5N/8 SW	D.165
1718150000	ZDV 2.5N/9 SW	D.165
1718160000	ZDV 2.5N/10 SW	D.165
1718341001	KLBU 15.32 SC	E.11
1718550000	WNT 35N 10X3	D.84

1720000000

1720620000	DEK 5/7.5 MC NEUTRAL	F.25
1720700000	ZVQ 2.5/1.5	C.141
1720920000	ZDUA 2.5-2	C.117
1720930000	ZDUA 2.5-2 BL	C.117
1720940000	ZDUA 2.5-2 OR	C.117
1720950000	ZPEA 2.5-2	C.117
1720960000	ZAP/TW ZDUA	C.117
1720970000	ZAP/TW ZDUA BL	C.117
1720980000	ZAP/TW ZDUA OR	C.117
1723660000	MOFU 15/35 ZDUB	C.115
1723800000	BS 35II KLBU HOLDER	E.12
1723810000	BS 35II KLBU3-8	E.12
1723820000	BS 35II/KLBU 4-13.5	E.12
1724580000	FM 4.2/TS35	F.14

1730000000

1730900000	ZSI 2.5/5X25	C.55
1730940000	WDU 2.5N/600UL	D.6
1739540000	ZDU 10S	C.73
1739550000	ZDU 10S BL	C.73
1739560000	ZNT 10S	C.74
1739570000	ZPE 10S	C.78
1739580000	ZDU 16S	C.73
1739590000	ZDU 16S BL	C.73
1739600000	ZNT 16S	C.75
1739610000	ZPE 16S	C.79
1739620000	ZDU 35	C.12
1739630000	ZDU 35 BL	C.12
1739640000	ZNT 35	C.75
1739650000	ZPE 35	C.43
1739660000	ZAP ZDU10/16S	C.132
1739680000	ZDV 10/2	C.141
1739690000	ZDV 16/2	C.141
1739700000	ZDV 35/2	C.12
1739890000	SCH-1WB	E.11

1740000000

1741260001	MC-Mobilo 110V/220V	F.40
1742630000	BTWZ KLBU	E.11
1745150000	ZAP/TW ZDU16	C.131
1745210000	ZAD 5/5	C.11
1745230000	ZDU 16	C.11
1745240000	ZDU 16 BL	C.11
1745250000	ZPE 16	C.42
1745350000	ZEI 16	C.11
1745400000	ZDTR 2.5	C.67
1745420000	AP ZDTR2.5	C.67
1745880000	ZDK 2.5V BL	C.22
1746730000	ZAD 4/5	C.10
1746750000	ZDU 10	C.10
1746760000	ZDU 10 BL	C.10
1746770000	ZPE 10	C.41
1747350000	TS 35X7.5 2M/CRN	F.10
1748660000	ZAP/TW ZDU10	C.131
1748800000	ZAP/TW ZDK2.5 BL	C.130
1749151001	KLBU CO 3	E.7
1749161001	KLBU CO 4	E.7
1749430000	BS 35II KLBU3-8/2X2-6	E.12
1749580000	ZAP/TW 10/16	C.131

Order No.	Type	Page
1750000000		
1752131001	KLBU CO 2	E.7
1752620000	ZAD 6/5	C.12
1752681001	KLBU 3-8 CPF	E.13
1752691001	KLBU 4-13.5 CPF	E.13
1752701001	KLBU 10-20 CPF	E.13
1752711001	KLBU 15-32 CPF	E.13
1753280000	WDU 1.5/R3.5	D.132
1753290000	WDK 1.5/R3.5	D.132
1753311001	KLBU CO 1	E.7
1754170000	WDU 1.5/R3.5 BL	D.132
1754190000	WAP WDU1.5/R3.5	D.133
1754200000	WAP WDK1.5/R3.5	D.132
1754210000	ZDV 1.5N/R3.5/2 GE	D.132
1754220000	ZDV 1.5N/R3.5/3 GE	D.132
1754230000	ZDV 1.5N/R3.5/4 GE	D.132
1754290000	ZDV 1.5N/R3.5/10 GE	D.132
1754960000	WTL 4	D.72
1754970000	WTL 4/STB	D.72
1755081001	KLBU CO 5	E.7
1755270000	DEK 5/3.5 MC NEUTRAL	F.25
1755280001	DEK 5/3.5 MC GW 1	F.22
1755280002	DEK 5/3.5 MC GW 2	F.22
1755280003	DEK 5/3.5 MC GW 3	F.22
1755280004	DEK 5/3.5 MC GW 4	F.22
1755280005	DEK 5/3.5 MC GW 5	F.22
1755280006	DEK 5/3.5 MC GW 6	F.22
1755280007	DEK 5/3.5 MC GW 7	F.22
1755280008	DEK 5/3.5 MC GW 8	F.22
1755280009	DEK 5/3.5 MC GW 9	F.22
1755281000	DEK 5/3.5 MC GW 0	F.22
1757970000	ZAP ZDU4/NT	C.76
1757980000	ZDU 4/NT	C.76
1758250000	ZDV 4N/2 GE	D.165
1758260000	ZDV 4N/10 GE	D.165

1760000000

1760720000	BS 35/WSH 2	E.9
1762320001	DEK 5/3.5 MC FSZ 1-10	F.22
1762320011	DEK 5/3.5 MC FSZ 11-20	F.22
1762320021	DEK 5/3.5 MC FSZ 21-30	F.22
1762320031	DEK 5/3.5 MC FSZ 31-40	F.22
1762320041	DEK 5/3.5 MC FSZ 41-50	F.22
1762320051	DEK 5/3.5 MC FSZ 51-60	F.22
1762320061	DEK 5/3.5 MC FSZ 61-70	F.22
1762320071	DEK 5/3.5 MC FSZ 71-80	F.22
1762320081	DEK 5/3.5 MC FSZ 81-90	F.22
1762320091	DEK 5/3.5 MC FSZ 91-100	F.22
1762320101	DEK 5/3.5 MC FSZ 101-110	F.22
1762320111	DEK 5/3.5 MC FSZ 111-120	F.22
1762320121	DEK 5/3.5 MC FSZ 121-130	F.22
1762320131	DEK 5/3.5 MC FSZ 131-140	F.22
1762320141	DEK 5/3.5 MC FSZ 141-150	F.22
1762420000	ZDU 10/NT	F.76
1762440000	ADAPTER ALU STI-S	C.39
1762620000	ZDV 4N/4 GE	D.165
1762630000	ZDV 4N/3 GE	D.165
1763940000	WTR 2.5/SI	D.50
1763950000	WTR 2.5/SI LD 36V	D.50
1764100000	ZAP/TW ZDU16 BL	C.11
1764110000	ZAP/TW ZDU10 BL	C.10
1764550000	ZBS1 ED SET	C.149
1764560000	ZAD 1/4/2 GE	C.147
1766240000	ZEI 16 BL	C.11
1767670000	ZPE 10/3AN	C.41
1767690000	ZDU 10/3AN	C.10
1767700000	ZDU 10/3AN BL	C.10
1767730000	DEK 5/3.5 MC bedruck	F.25
1768000000	ZMAK 2.5	C.34
1768010000	ZAP ZMAK2.5	C.34
1768020000	BS 35II KLBU2X3-8/2X2-6	E.12
1768090000	WS 14/5 MC NEUTRAL	F.28
1768310000	ZPE 16/3AN	C.42
1768320000	ZDU 16/3AN	C.11
1768330000	ZDU 16/3AN BL	C.11
1768520000	ZAP/TW 10/16 BL	C.131
1768540000	Plotterpen 0,25	F.39
1768550000	Plotterpen 0,35	F.39
1768560000	Plotterpen 0,5	F.39
1768570000	Plotterpen 0,18	F.39
1768800000	ZDK 2.5 EM	C.123

1770000000

1770360000	ZDU 4-2/3AN	C.15
1770370000	ZDU 4-2/2AN	C.15
1770380000	ZPE 4-2/2AN	C.45
1770390000	ZPE 4-2/3AN	C.45
1770400000	ZAP ZDU4-2	C.131
1770490000	DEK 5/7.5 MC SONDERDR.	F.25
1770840000	ZDU 4-2/2AN BL	C.15
1770860000	ZDU 4-2/3AN BL	C.15
1770870000	ZDU 4-2/3AN OR	C.153
1770880000	ZAP ZDU4-2 BL	C.131
1770890000	ZAP ZDU4-2 OR	C.131
1771360000	ZPE 6-2/3AN	C.47
1771370000	ZPE 6-2/2AN	C.46

Order No.	Type	Page
1771380000	ZDU 6-2/2AN	C.17
1771390000	ZDU 6-2/2AN BL	C.17
1771400000	ZDU 6-2/2AN OR	C.153
1771410000	ZDU 6-2/3AN	C.17
1771420000	ZDU 6-2/3AN BL	C.17
1771430000	ZDU 6-2/3AN OR	C.153
1771440000	ZAP ZDU6-2	C.131
1771450000	ZAP ZDU6-2 BL	C.131
1771460000	ZAP ZDU6-2 OR	C.131
1771800000	ZTL 6	C.68
1771810000	ZTD 6	C.68
1771820000	KSBR/2 ZTL6	C.68
1771830000	KSBR/3 ZTL6	C.69
1771840000	KSBR/4 ZTL6	C.69
1771860000	SSP ZTL6	C.68
1771870000	ZTW ZTL6	C.133
1771880000	ZTW ZTL6 OR	C.133
1771950000	ZTL 6/STB	C.69
1771960000	ZTD 6/STB	C.69
1772060000	ZDU 2.5-2	C.14
1772070000	ZDU 2.5-2 BL	C.14
1772080000	ZDU 2.5-2 OR	C.152
1772090000	ZPE 2.5-2	C.44
1772120000	Tinte 2000 25ml	F.39
1772130000	Reimiger 2000 25ml	F.39
1772940000	ZEI 16-2/1AN	C.17
1772950000	ZEI 16-2/1AN BL	C.17
1772960000	ZPE 16-2/1AN	C.47
1772970000	ZAP_Z_16-2/1AN	C.131
1773410000	AP 100 GR	D.158
1773521686	WS 8/5 MC NEUTRAL RT	F.28
1773521687	WS 8/5 MC NEUTRAL GE	F.28
1773521690	WS 8/5 MC NEUTRAL OR	F.28
1773521693	WS 8/5 MC NEUTRAL BL	F.28
1773531686	WS 10/5 MC NEUTRAL RT	F.28
1773531687	WS 10/5 MC NEUTRAL GE	F.28
1773531693	WS 10/5 MC NEUTRAL BL	F.28
1773541686	WS 12/5 MC NEUTRAL RT	F.28
1773541687	WS 12/5 MC NEUTRAL GE	F.28
1773541690	WS 12/5 MC NEUTRAL OR	F.28
1773541693	WS 12/5 MC NEUTRAL BL	F.28
1773551686	WS 12/6 MC NEUTRAL RT	F.28
1773551687	WS 12/6 MC NEUTRAL GE	F.28
1773551689	WS 12/6 MC NEUTRAL VI	F.28
1773551690	WS 12/6 MC NEUTRAL OR	F.28
1773551692	WS 12/6 MC NEUTRAL BR	F.28
1773551693	WS 12/6 MC NEUTRAL BL	F.28
1773561686	WS 12/6,5 MC neutral RT	F.29
1773561687	WS 12/6,5 MC neutral GE	F.29
1773561688	WS 12/6,5 MC neutral GN	F.29
1773561693	WS 12/6,5 MC neutral BL	F.29
1773571687	WS 15/5 MC neutral GE	F.28
1775480000	ZDU 1.5	C.4
1775490000	ZDU 1.5 BL	C.4
1775500000	ZDU 1.5 OR	C.152
1775510000	ZPE 1.5	C.36
1775530000	ZDU 1.5/3AN	C.4
1775540000	ZDU 1.5/3AN BL	C.4
1775550000	ZDU 1.5/3AN OR	C.152
1775560000	ZPE 1.5/3AN	C.36
1775580000	ZDU 1.5/4AN	C.5
1775600000	ZDU 1.5/4AN BL	C.5
1775610000	ZDU 1.5/4AN OR	C.152
1775620000	ZPE 1.5/4AN	C.37
1776030000	ZAP/TW ZDU1.5/2AN	C.130
1776040000	ZAP/TW ZDU1.5/2AN BL	C.4
1776050000	ZAP/TW ZDU1.5/2AN OR	C.130
1776060000	ZAP/TW ZDU1.5/3AN	C.130
1776070000	ZAP/TW ZDU1.5/3AN BL	C.4
1776080000	ZAP/TW ZDU1.5/3AN OR	C.130
1776090000	ZAP/TW ZDU1.5/4AN	C.130
1776100000	ZAP/TW ZDU1.5/4AN BL	C.5
1776110000	ZAP/TW ZDU1.5/4AN OR	C.130
1776120000	ZDV 1.5/2	C.140
1776130000	ZDV 1.5/3	C.140
1776140000	ZDV 1.5/4	C.140
1776150000	ZDV 1.5/5	C.140
1776200000	ZDV 1.5/10	C.140
1776210000	ZTA 5	C.143
1776220000	ZTA 5/2A	C.143
1778080000	ZDU 4/NT DB	C.76
1778270000	WS 12/3,5 MC neutral	F.28
1778280000	WS 12/3,5 MC Sonderdr.	F.28
1779000000	ZDU 2.5-2/D-	C.122
1779010000	ZTR 2.5-2	C.70
1779020000	ZTR 2.5-2/0.TNHE	C.70
1779100000	TSTW 5/MS ZN	F.13
1779110000	ZDU 2.5-2/D+	C.122
1779120000	ZTR 2.5-2 BL	C.70
1779130000	ZTR 2.5-2 OR	C.70

1780000000

1780660000	ZTA 6/2A	C.142
1780670000	ZTA 7/2A	C.142
1780850000	WF 6	D.144
1780860000	WF 8	D.145
1780870000	WF 10	D.145
1780880000	WF 12	D.1

Order No.	Type	Page
1802800000	WQB 240/3	D.13
1802810000	WZAD 240	D.13
1803890000	ZHP ZDU4/NT SO	C.76
1805480000	BZT 2 WS 10/5	F.30
1805490000	BZT 1 WS 10/5	F.30
1805520000	BZT 1 ZA WS 10/5	F.30
1805530000	BZT 2 ZA WS 10/5	F.30
1805610000	MEW 35/1	F.12
1805880000	SNAPMARK I	F.30
1805940000	ZDKPE 2.5-2	C.29
1805960000	ZAP/TW ZDKPE2.5-2	C.29
1805980000	TS 35X15/6X18 2M/ST/ZN	F.10
1806120000	EM 8/30	F.33
1806620000	WQL 2 WF6-10	D.150
1806630000	IS 2 KG	F.63
1806640000	WQL 3 WF6-10/2	D.150
1806650000	IS 3 KG	F.63
1806660000	IS 4 KG	F.63
1806980000	ZDU 4-2/4AN	C.16
1806990000	ZDU 4-2/4AN BL	C.16
1807010000	ZAP ZDU4-2/4AN	C.131
1807020000	ZAP ZDU4-2/4AN BL	C.16
1807030000	ZAP ZDU4-2/4AN OR	C.131
1807090000	ZPE 4-2/4AN	C.46
1808010000	ZDU 2.5 S	C.72
1808020000	ZDU 2.5 S BL	C.72
1808030000	ZAP ZDU 2.5 S	C.132
1808040000	ZAP ZDU 2.5 S BL	C.72
1808050000	ZAP ZDU 2.5 S OR	C.132
1808170000	ZAP/TW ZDU2.5-2N	C.118
1808180000	ZDUA 2.5-2N BL	C.118
1808200000	ZDUA 2.5-2N	C.118
1808210000	ZPEA 2.5-2N	C.118
1808230000	ZDU 6 S	C.73
1808240000	ZDU 6 S BL	C.73
1808250000	ZAP ZDU 6 S	C.132
1808260000	ZAP ZDU 6 S BL	C.132
1808280000	ZHP S SO	C.132
1808290000	ZHP S	C.132
1808320000	ZNT 6 S	C.74
1808330000	ZPE 2.5 S	C.77
1808340000	ZPE 4 S	C.77
1808350000	ZPE 6 S	C.78
1808360000	ZDU 4 S	C.72
1808370000	ZDU 4 S BL	C.72
1808380000	ZAP ZDU 4 S	C.132
1808390000	ZAP ZDU 4 S BL	C.72
1808980000	WQL 2 WF6.8	D.150
1809110000	ST 4000/S M8	D.152
1809120000	ST 4000/S M8 F	D.152
1809130000	ST 4000/S M10	D.152
1809140000	ST 4000/S M10 F	D.152
1809150000	ST 4000/L M10	D.153
1809160000	ST 4000/L M10 F	D.153
1809170000	ST 4000/L M12	D.153
1809180000	ST 4000/L M12 F	D.153
1809190000	ST 4000/S P150	D.152
1809200000	ST 4000/L P180	D.153
1809210000	ST 4000/S E150	D.152
1809220000	ST 4000/L E180	D.153
1809230000	ST 4000/S C130	D.152
1809240000	ST 4000/L C160	D.153
1809250000	ST 4000/S CB M8/4	D.152
1809260000	ST 4000/S CB M10/4	D.152
1809270000	ST 4000/S CB M10/6	D.152
1809280000	ST 4000/L CB M10/4	D.153
1809290000	ST 4000/L CB M12/4	D.153
1809300000	ST 4000/L CB M12/6	D.153
1809310000	ST 4000/S J2 M8	D.152
1809320000	ST 4000/S J3 M8	D.152
1809340000	ST 4000/S J2 M10	D.152
1809350000	ST 4000/S J3 M10	D.152
1809360000	ST 4000/S J4 M10	D.152
1809370000	ST 4000/L J2 M10	D.153
1809390000	ST 4000/L J4 M10	D.153
1809400000	ST 4000/L J2 M12	D.153
1809410000	ST 4000/L J3 M12	D.153
1809420000	ST 4000/L J4 M12	D.153
1809470000	ST 4000/S S150	D.152
1809480000	ST 4000/L S180	D.153

1810000000

1812710000	WQL 2 WF5	D.144
1812740000	WQL 3 WF5	D.144
1814660000	ZF 4 S BL	F.7
1814670000	ZF 4 S GN	F.7
1814680000	ZF 4 S	F.7
1814690000	ZSI 6-2/FC	C.62
1814700000	ZSI 6-2/FC LD	C.62
1814710000	ZAP ZDU6-2 SW	C.131
1815070000	ZT 2.5/2AN/1	C.82
1815080000	ZTPE 2.5/2AN/1	C.86
1815090000	ZT 2.5/3AN/1	C.82
1815100000	ZTPE 2.5/3AN/1	C.86
1815110000	ZT 2.5/4AN/2	C.83
1815120000	ZTPE 2.5/4AN/2	C.87
1815130000	ZT 2.5/4AN/4	C.83
1815140000	ZTPE 2.5/4AN/4	C.87

Order No.	Type	Page
1815150000	ZDT 2.5/2	C.90
1815160000	ZDT 2.5/2 DU-PE	C.91
1815170000	ZDT 2.5/2 PE	C.92
1815180000	ZP 2.5/1AN/17	C.96
1815190000	ZP 2.5/1AN/QV/1	C.97
1815200000	ZP 2.5/1AN/QV/2	C.97
1815210000	ZP 2.5/1AN/QV/3	C.97
1815220000	ZP 2.5/1AN/QV/4	C.97
1815230000	ZP 2.5/1AN/QV/5	C.97
1815240000	ZP 2.5/1AN/QV/6	C.97
1815250000	ZP 2.5/1AN/QV/7	C.97
1815260000	ZP 2.5/1AN/QV/8	C.97
1815270000	ZP 2.5/1AN/QV/9	C.97
1815280000	ZP 2.5/1AN/QV/10	C.97
1815290000	ZP 2.5/1AN/QV/11	C.97
1815300000	ZP 2.5/1AN/QV/12	C.97
1815310000	ZP 2.5/1AN/QV/13	C.97
1815320000	ZP 2.5/1AN/QV/14	C.97
1815330000	ZP 2.5/1AN/QV/15	C.97
1815340000	ZP 2.5/1AN/QV/16	C.97
1815350000	ZP 2.5/1AN/QV/17	C.97
1815430000	ZP 2.5/1AN/1	C.83
1815440000	ZP 2.5/1AN/2	C.83
1815450000	ZP 2.5/1AN/3	C.83
1815500000	ZP 2.5/1AN/4	C.83
1815510000	ZP 2.5/1AN/5	C.83
1815520000	ZP 2.5/1AN/6	C.96
1815530000	ZP 2.5/1AN/7	C.83
1815540000	ZP 2.5/1AN/8	C.83
1815550000	ZP 2.5/1AN/9	C.83
1815560000	ZP 2.5/1AN/10	C.83
1815570000	ZP 2.5/1AN/11	C.96
1815580000	ZP 2.5/1AN/12	C.96
1815590000	ZP 2.5/1AN/13	C.96
1815600000	ZP 2.5/1AN/14	C.96
1815610000	ZP 2.5/1AN/15	C.96
1815620000	ZP 2.5/1AN/16	C.96
1815720000	ZP 2.5/1AN/24	C.96
1815730000	ZP 2.5/2AN/QV/1	C.97
1815740000	ZP 2.5/2AN/QV/2	C.97
1815750000	ZP 2.5/2AN/QV/3	C.97
1815760000	ZP 2.5/2AN/QV/4	C.97
1815770000	ZP 2.5/2AN/QV/5	C.97
1815780000	ZP 2.5/2AN/QV/6	C.97
1815790000	ZP 2.5/2AN/QV/7	C.97
1815800000	ZP 2.5/2AN/QV/8	C.97
1815810000	ZP 2.5/2AN/QV/9	C.97
1815820000	ZP 2.5/2AN/QV/10	C.97
1815830000	ZP 2.5/2AN/QV/11	C.97
1815840000	ZP 2.5/2AN/QV/12	C.97
1815850000	ZP 2.5/2AN/QV/13	C.97
1815860000	ZP 2.5/2AN/QV/14	C.97
1815870000	ZP 2.5/2AN/QV/15	C.97
1815880000	ZP 2.5/2AN/QV/16	C.97
1816030000	ZAP/TW ZT2.5/2AN	C.133
1816040000	ZAP/TW ZT2.5/2AN OR	C.133
1816050000	ZAP/TW ZT2.5/3AN	C.133
1816060000	ZAP/TW ZT2.5/3AN OR	C.82
1816070000	ZAP/TW ZT2.5/4AN/2	C.133
1816080000	ZAP/TW ZT2.5/4AN/2 OR	C.133
1816090000	ZAP/TW ZT2.5/4AN/4	C.133
1816110000	ZAP/TW ZT2.5/2	C.133
1816130000	ZVR ZP2.5	C.103
1816140000	ZZE ZP2.5	C.103
1816150000	KOSF ZT2.5	C.100
1818400000	WS 10/6 MC Midd. Neutr.	F.29
1818410000	WS 10/6 MC Midd. Sonder	F.29

1820000000

1820550000	WDU 95N/120N	D.13
1820560000	WDU 95N/120N BL	D.13
1820570000	ZP 2.5/1AN/QV/1 GN	C.97
1820580000	ZP 2.5/1AN/1/3 AN	C.96
1820590000	ZP 2.5/2AN/QV/1 GN	C.97
1820840000	WDU 50N	D.12
1820850000	WDU 50N BL	D.12
1820860000	ZSI 6-2 2X2.5/G20/GL	C.60
1820930000	ZSI 6-2 2X2.5/G20	C.60
1820940000	ZSI 6-2 2X2.5/G25/GL	C.60
1820950000	ZSI 6-2 2X2.5/G25	C.60
1822210000	WDU 240 BL	D.13
1826030000	ZSI 2.5-2/2X2AN/G20/GL	C.58
1826050000	ZSI 2.5-2/2X2AN/G20	C.58
1826090000	ZSI 2.5-2/2X2AN/G25/GL	C.58
1826200000	ZSI 2.5-2/2X2AN/G25	C.58
1826890000	WQV 95/120/2	D.13
1826900000	WQV 95/120/3	D.13
1826910000	WQV 95/120/4	D.13
1826970000	ZDU 1.5/2X2AN	C.5
1826990000	ZDU 1.5/2X2AN BL	C.5
1827000000	ZDU 1.5/2X2AN OR	C.152
1827080000	ZTA ZT2.5	C.142
1828450000	WS 10/6 MC NEUTRAL	F.28
1828460000	WS 10/6 MC Sonderdruck	F.28

Order No.	Type	Page
1830420000	ZDU 6 RT	C.153
1830610000	ZDU 10 OR	C.153
1830650000	ZDU 16 SW	C.153
1830680000	ZDU 16 OR	C.153
1830760000	ZDU 35 OR	C.153
1831130000	ZTR 2.5/0.TNHE	C.66
1831260000	ZDK 2.5-2 OR	C.152
1831280000	ZTR 2.5	C.66
1833090000	TNST	D.178
1833100000	BEST	D.178
1833340000	WDU 10 GN	D.181
1833350000	WDU 10 GE	D.181
1833380000	WDU 10 WS	D.181
1833400000	WDU 16 RT	D.181
1833420000	WDU 16 SW	D.181
1833600000	WDK 2.5/TR-DU/0 TNHE	D.60
1833610000	WDK 2.5/TR-DU/0 TNHE StB	D.60
1833640000	WDK 2.5/TR-DU-PE/0 TNHE	D.61
1833670000	WDK 2.5/TR-DU-PE/0 TNHE StB	D.61
1834060000	WQV 50N/2	D.12
1834070000	WQV 50N/3	D.12
1834080000	WQV 50N/4	D.12
1835840000	KLBUE 3-8 SDSC	E.11
1836370000	QVAR 1	C.134
1836550000	WDU 35N KB BL	D.181
1837030000	PDL 4 S/L/PE	B.30
1837040000	PDL 4 S/L/L/PE	B.32
1837050000	PDL 4 S/N/L/PE	B.31
1837060000	PDL 4 S/NT/L/PE	B.30
1837070000	PAP PDL4S	B.30
1837080000	PHP PDL SO	B.30
1837090000	PHP PDL	B.30
1839850000	WAP WDK 2.5N/TR-DU	D.60

1840000000

1846030000	WPE 95N/120N	D.31
1846040000	WPE 50N	D.30
1847600000	ZTA ZT2.5/ZA	C.142
1847610000	PDL 4 S/L	B.31
1847620000	PDL 4 S/N	B.32
1847630000	PDL 4 S/N/L	B.31
1847740000	STB 36.8/1H/DB WTL6/1	B.23
1847760000	STB 36.8/1H/GE WTL6/1	D.73
1847770000	STB 36.8/1H/GN WTL6/1	D.73
1847780000	STB 36.8/1H/VI WTL6/1	D.71
1847790000	STB 36.8/1H/BL WTL6/1	D.73
1848290000	TS 35X15/2.3 2M/AL/BK	F.10
1848330000	ZTPE 4/4AN/2	C.88
1848340000	ZT 4/1AN/1	C.85
1848350000	ZT 4/4AN/2	C.85
1848480000	Feko ZRV2.5 1.5-2.5	C.95

1850000000

1854090000	WS 10/15 MC Neutr.	F.29
1854100000	WS 10/15 MC Sonderdruck	F.29
1854490000	DEK 5/5 PLUS MC NEUTRAL	F.25
1854500000	DEK 5/5 PLUS MC SONDERDR.	F.25
1854750000	Feko ZRV2.5 0.2-0.35	C.95
1854760000	Feko ZRV2.5 0.5-1	C.95
1854960000	ZT 4/2AN/1	C.85
1854970000	ZTPE 4/2AN/1	C.88
1854980000	ZP 4/1AN/1 GN	C.97
1854990000	ZP 4/1AN/2	C.85
1855000000	ZP 4/1AN/3	C.85
1855010000	ZP 4/1AN/4	C.85
1855020000	ZP 4/1AN/5	C.85
1855030000	ZP 4/1AN/6	C.85
1855040000	ZP 4/1AN/7	C.85
1855050000	ZP 4/1AN/8	C.85
1855060000	ZP 4/1AN/9	C.85
1855070000	ZP 4/1AN/10	C.85
1855080000	ZP 4/1AN/11	C.97
1855090000	ZP 4/1AN/12	C.97
1855100000	ZP 4/1AN/13	C.97
1855110000	ZP 4/1AN/14	C.97
1855120000	ZP 4/1AN/15	C.97
1855130000	ZP 4/1AN/16	C.97
1855220000	ZAP/TW ZT4/2AN	C.85
1855230000	ZAP/TW ZT4/2AN OR	C.85
1855240000	ZAP/TW ZT4/4AN/2 OR	C.85
1855250000	ZVR ZP4	D.102
1855260000	ZZE ZP4	D.102
1855610000	WTR 2.5	D.54
1855620000	WTR 2.5 STB2.3	D.54
1856740000	DEK 5/8 MC Neutral	F.25
1856750000	DEK 5/8 MC Sonderdruck	F.25
1856860000	KOSF ZT4	D.102
1858920000	Tintantank PrintJet II	F.36

Order No.	Type	Page
1896230000	PDU 2.5/4 BL	B.4
1896240000	PDU 2.5/4/3AN BL	B.4
1896250000	PDU 2.5/4/4AN BL	B.5
1896270000	PDU 6/10 BL	B.5
1896280000	PDU 6/10/3AN BL	B.6
1896290000	PAP 16	B.7
1896300000	PAP 2.5/4	B.8
1896320000	PAP 2.5/4/4AN	B.4
1896330000	PAP PDU6/10	B.5
1896340000	PAP PDU6/10/3AN	B.6
1896350000	PNT 16	B.29
1896360000	PNT 2.5/4	B.28
1896370000	PNT 6/10	B.28
1896380000	PHP PNT16	B.29
1896390000	PHP PNT 2.5/4	B.28
1896400000	PDU 16	B.7
1896480000	PAP 2.5/4/3AN	B.11
1897000000	DS 13.5 WTL6/4FF	D.76
1897010000	QL 2 WTL6/4FF	D.76
1897020000	QL 3 WTL6/4FF	D.76
1897030000	QL 4 WTL6/4FF	D.76
1897090000	QL 10 WTL 6/4 FF	D.76
1897100000	QL 50 WTL6/4FF	D.76
1897110000	Q 2 WTL6/2FF	D.76
1897120000	Q 3 WTL6/2FF	D.76
1897130000	Q 4 WTL 6/4FF	D.76
1897190000	Q 10 WTL 6/4FF	D.76
1898420000	STGH 0.R/SW ZRV2.5	C.95
1898430000	STGH 0.ZA/0.R/SW ZRV2.5	C.95
1898450000	ZTC 2.5/4AN/4	C.84
1898480000	ZTCE 2.5/4AN/4	C.87
1899170000	MOFU 15/35 ZPS2.5	C.105
1899180000	PDL 4/N/L/PE	B.34
1899190000	PDL 4/TR/DU	B.22
1899200000	PDL 4/TR/DU/PE	B.22
1899210000	PDL 4/TR/DU 0 TNHE	B.21
1899220000	PDL 4/TR/DU/PE 0 TNHE	B.21

1900000000

1904960000	WOL 4 WF8-6/3	D.150
1905060000	WDU 4/ZZ	D.7
1905070000	WAP WDU/WTR4/ZR	D.157
1905080000	WTR 4/ZR	D.57
1905090000	WTR 4/ZZ	D.56
1905100000	WTR 4/ZZ STB	D.56
1905110000	WTR 4/ZR STB	D.57
1905120000	WPE 4/ZR	D.25
1905130000	WPE 4/ZZ	D.25
1905140000	WDU 4/ZR	D.7
1905150000	WAP WDU/WTR4/ZZ	D.157
1905170000	ZDK 4-2/N/L	C.31
1905470000	ZTR 2.5 0 TNHE	C.93
1905490000	M-PRINT PRO	F.41
1905500000	M-PRINT PRO ADVANCED	F.41
1905950000	WS 10/8 PLUS MC NE WS	F.29
1905970000	WS 10/12 MC NEUTRAL	F.29
1906000000	WS 12/8 PLUS MC NE WS	F.29
1906010000	WS 12/8 PLUS MC SDR	F.29
1906030000	WS 10/8 PLUS MC SDR	F.29
1906060000	WS 10/12 MC SONDERDRUCK	F.29
1906210000	ZDV 6N/2	B.5
1906220000	ZDV 6N/3	B.5
1906230000	ZDV 6N/4	B.5
1906240000	ZDV 6N/20	B.5
1906960000	ZRV 2.5/1	C.95
1906970000	ZRV 2.5/2	C.95
1906980000	AP ZRV2.5	C.95
1907000000	STGH ZRV2.5	C.95
1907010000	STGH 0.ZA ZRV2.5	C.95
1907520000	DEK 5/5 PLUS MC GE	F.25
1908550000	BA ZPS2.5	C.105
1908560000	BA RC ZPS2.5	C.105
1908960000	ZDV 2.5/20	C.140
1908990000	ZDV 6/24 GE	C.141
1909000000	ZDV 2.5N/20 GE	D.165
1909010000	ZDV 4/20 GE	C.140
1909020000	ZDV 4N/20 GE	D.165
1909100000	ZDV 4N/20 BL	D.165
1909110000	ZDV 2.5N/20 RT	D.165
1909120000	ZDV 4N/20 SW	D.165
1909130000	ZDV 2.5N/20 SW	D.165
1909140000	ZDV 2.5N/20 BL	D.165
1909150000	ZDV 4N/20 RT	D.165

1910000000

1915450000	WTA 8 TN	D.72
1915480000	WTA 8 KO-TN	D.175
1916150000	PAD 2.5/4/4	B.4
1916160000	PAD 6/10/4	B.5
1916170000	PAD 16/4	B.7
1916180000	PTA PDU2.5/4	B.4
1916190000	PTA ZA PDU2.5/4	B.4
1916400000	PRH 2.5/4/2	B.4
1916410000	PRH 2.5/4/1	B.4
1916790000	PHP PNT 2.5/4 SD	B.28
1917410000	WS 10/6 MC MIDDLE OR	F.28
1917420000	WS 10/6 MC MIDDLE GN	F.28

Order No.	Type	Page
1917430000	WS 10/6 MC MIDDLE GE	F.28
1917440000	WS 10/6 MC MIDDLE RT	F.28
1918680000	PKD 2.5/4V BL	B.8
1918710000	PKD 2.5/4 PE	B.15
1918720000	PKD 2.5/4LPE	B.8
1918730000	PKD 2.5/4V	B.9
1918740000	PKD 2.5/4N-L	B.9
1918760000	PKD 2.5/4 BL	B.8
1918770000	PKD 2.5/4	B.8
1918780000	PEI 16	B.7
1918790000	PEI 16 BL	B.7
1919690000	PHP PNT16 SD	B.29
1919710000	PHP PNT 6/10 SD	B.28
1919720000	PAP PDK 2.5/4	B.8

1920000000

1920640000	PLOTTER PEN 0.25 PINK	F.39
1920650000	PLOTTER PEN 0.35 PINK	F.39
1924310000	MCP AP SF4-6	F.39
1924320000	MCP KLEBESTREIFEN	F.39
1924330000	P-CLEANER	F.39
1924340000	P-Ink 2.0	F.39
1924350000	MCP COVER	F.39
1924360000	MCP AP PLUS	F.39
1924370000	MCP AP LABELS	F.39
1924450000	ZDK 2.5/3AN D2	C.127
1924460000	ZDK 2.5/3AN DU-PE	C.33
1924470000	ZDK 2.5/3AN PE	C.52
1924480000	ZDK 2.5/3AN V BL	C.32
1924490000	ZDK 2.5/3AN V	C.32
1924500000	ZDK 2.5/3AN BL	C.32
1924510000	ZDK 2.5/3AN	C.32
1924910000	ZAP/TW ZDK 2.5/3AN	C.127
1925000000	MCP PLUS	F.137
1927510000	WS 12/5 PLUS MC NEUTRAL	F.28
1927520000	WS 12/5 PLUS SONDERDRUCK	F.28
1927530000	WS 12/6 PLUS MC NEUTRAL	F.28
1927540000	WS 12/6 PLUS SONDERDRUCK	F.29

1930000000

1933700000	ZDU 2.5N	C.18
1933710000	ZDU 2.5N BL	C.18
1933720000	ZDU 2.5N/3AN	C.18
1933730000	ZDU 2.5N/3AN BL	C.18
1933740000	ZDU 2.5N/4AN	C.19
1933750000	ZDU 2.5N/4AN BL	C.19
1933760000	ZPE 2.5N	C.48
1933770000	ZPE 2.5N/3AN	C.48
1933780000	ZPE 2.5N/4AN	C.49
1933790000	ZAP/TW ZDU/ZPE 2.5N	C.18
1933800000	ZAP/TW ZDU/ZPE 2.5N/3AN	C.18
1933810000	ZAP/TW ZDU/ZPE 2.5N/4AN	C.19
1933890000	PTR 2.5/4/4AN 0 TNHE	B.20
1933910000	PTR 2.5/4 0 TNHE	B.18
1933930000	PTR 2.5/4/3AN BL	B.19
1933940000	PTR 2.5/4/4AN	B.19
1933950000	PTR 2.5/4	B.18
1933970000	PTR 2.5/4 BL	B.18
1933980000	PTR 2.5/4/3AN	B.19
1933990000	PTR 2.5/4/3AN 0 TNHE	B.19
1934000000	PTR 2.5/4/4AN BL	B.19
1934160000	ZAD 9/4	C.147
1934680000	PAP PTR2.5/4	B.18
1934690000	PAP PTR2.5/4/3AN	B.19
1934700000	PAP PTR2.5/4/4AN	B.19
1934790000	WTQ 6/1 EN	D.73
1934800000	WTQ 6/1 EN STB	D.73
1934810000	WTL 6/1 EN	D.73
1934820000	WTL 6/1 EN STB	D.73
1934830000	WTD 6/1 EN	D.63
1935130000	MCP EP	F.39
1936140000	WKS 2/2	D.74
1936150000	WKS 2/3	D.74
1936160000	WKS 2/4	D.73
1936240000	STB 21.6/45 GE	D.71
1936250000	STB 21.6/45 GN	D.71
1936260000	STB 21.6/45 V	D.71
1936270000	STB 21.6/45 SW	D.71
1936280000	STB 21.6/45 GN	D.71
1936290000	STB 21.6/45 BL	D.71
1936300000	STB 21.6/45 RT	D.71
1938790000	STB 21.6/45 DB	D.71
1938820000	WTL 6/1/STB/TNSC/EN	D.74
1939440000	WPDB 16/6 3/4	D.122
1939450000	WPDB 35-16/16 1-1/6	D.122
1939460000	WPDB 70/16 1/10	D.123
1939470000	WPDB 120/35-16-10 1/2-5/4	D.124
1939480000	WPDB 185/35-16-10 1/2-5/4	D.124
1939490000	WPDB 3x70/16 1/6	D.125
1939500000	WPDB 70/16 1/6	D.126
1939510000	WPDB 35/16/6/N 1/2/5/11	D.126

1940000000

1946210000	ZDU 2.5-2/3AN SW	C.152
1946220000	ZDU 2.5-2/3AN RT	C.152
1946230000	ZDU 2.5-2/3AN WS	C.152

Order No.	Type	Page
1946240000	ZDU 2.5-2/3AN GE	C.152
1948000000	BLZP 5.08/02/90 SN OR BX	D.112
1948020000	BLZP 5.08/04/90 SN OR BX	D.112
1948060000	BLZP 5.08/08/90 SN OR BX	D.112
1948110000	BLZP 5.08/12/90 SN OR BX	D.112
1948150000	BLZP 5.08/16/90 SN OR BX	D.112
1948240000	BLZP 5.08/02/90 SN BK BX	D.112
1948260000	BLZP 5.08/04/90 SN BK BX	D.112
1948300000	BLZP 5.08/08/90 SN BK BX	D.112
1948340000	BLZP 5.08/12/90 SN BK BX	D.112
1948380000	BLZP 5.08/16/90 SN BK BX	D.112
1949800000	BLZP 5.08/02/90F SN OR BX	D.112
1949820000	BLZP 5.08/04/90F SN OR BX	D.112
1949860000	BLZP 5.08/08/90F SN OR BX	D.112
1949900000	BLZP 5.08/12/90F SN OR BX	D.112
1949940000	BLZP 5.08/16/90F SN OR BX	D.112

1950000000

1950040000	BLZP 5.08/02/90F SN BK BX	D.112
1950060000	BLZP 5.08/04/90F SN BK BX	D.112
1950100000	BLZP 5.08/08/90F SN BK BX	D.112
1950140000	BLZP 5.08/12/90F SN BK BX	D.112
1950180000	BLZP 5.08/16/90F SN BK BX	D.112
1951870000	WS 8/5 PLUS MC NEUTRAL	F.28
1951880000	WS 8/6 PLUS MC NEUTRAL	F.28
1951920000	DEK 5/30 MC NEUTRAL	F.33
1957710000	WAP WTL6/1 EN	D.74

1960000000

1964830000	WZAD 70N	D.13
1966020000	WSI 25/1 10x38	D.46
1966030000	WSI 25/3 CC	D.46
1966040000	WSI 25/2 CC	D.46
1966050000	WSI 25/1 CC	D.46
1966060000	WSI 25/1 10x38/LED	D.46
1966070000	WSI 25/1 CC/LED	D.46
1966080000	WSI 25/3 10x38	D.46
1966090000	WSI 25/2 10x38	D.46
1966380000	WAP 2.5-10/0.5mm	D.156
1967200000	ZT 2.5/2X2AN	C.83

1970000000

1972980000	ZP 2.5/1AN ZA 0.RA BL	C.98
------------	-----------------------	------

2010000000

2012420000	STB 14/D6/4/M3 SAK10	D.74
------------	----------------------	------

2260000000

2269800000	KLBUE 4-6 Z/1	E.14
------------	---------------	------

2310000000

2318670000	ZE ZRV2.5	C.95
------------	-----------	------

2320000000

2321640000	STGH ZPC2.5 DB	C.84
------------	----------------	------

3890000000

3896100000	SP M6 15 MSZN	E.10
3896200000	SP M6 20 MSZN	E.10
3896300000	SP M6 30 MSZN	E.10

4060000000

4062150000	PJ-Clean Unit	F.36
------------	---------------	------

7900000000

7904100000	ZAP/TW 4/3AN	C.131
7904110000	ZAP/TW 4/3AN BL	C.8
7904120000	ZAP/TW 4/3AN OR	C.131
7904170000	ZPE 4/3AN	C.39
7904180000	ZDU 4/3AN	C.8
7904190000	ZDU 4/3AN BL	C.8
7904210000	ZAP/TW4/4AN	C.131
7904220000	ZAP/TW4/4AN BL	C.9
7904230000	ZAP/TW4/4AN OR	C.131
7904280000	ZPE 4/4AN	C.39
7904290000	ZDU 4/4AN	C.9
7904300000	ZDU 4/4AN BL	C.9
7906040000	BK 2/E	D.138
7906060000	BK 3/E	D.138
7906080000	BK 4/E	D.138
7906090000	BK 6/E	D.138
7906100000	BK 12/E	D.138
7906110000	MK 3/2/E	D.138
7906120000	MK 3/3/E	D.138
7906130000	MK 3/4/E	D.138
7906150000	MK 3/6/E	D.138

Order No.	Type	Page
-----------	------	------

8810000000

8817920000	ZTR 6-2 E / 24V DC	C.71
8817930000	ZTR 6-2 E / 230V UC	C.71

8870000000

8870840000	SRC1 QV P	B.38
------------	-----------	------

9000000000

9002170000	KT ZDV	F.44
9002650000	KT 8	F.42
9002660000	KT 12	F.42
9004050000	H0,5/10	F.77
9004060000	H1,5/12	F.77
9004070000	H1,5/18	F.77
9004080000	H2,5/10	F.77
9004090000	H2,5/18	F.77
9004100000	H4,0/15	F.77
9004110000	H4,0/18	F.77
9004120000	H6,0/10	F.77
9004130000	H6,0/18	F.77
9004140000	H1,5/24D SW SV	F.70
9004150000	H16,0/25	F.77
9004160000	H16,0/32	F.77
9004170000	H25,0/25	F.77
9004180000	H25,0/32	F.77
9004190000	H35,0/25	F.77
9004200000	H35,0/32	F.77
9004210000	H50,0/18	F.77
9004220000	H50,0/32	F.77
9004230000	H70,0/25	F.77
9004240000	H70,0/32	F.77
9004250000	H95,0/25	F.77
9004260000	H95,0/32	F.77
9004270000	H0,5/14 OR BD	F.67
9004280000	H0,5/14D W BD	F.68
9004290000	H0,75/14 W BD	F.67
9004300000	H0,75/14D GR BD	F.68
9004310000	H0,75/14T HBL BD	F.70
9004320000	H1,0/14 GE BD	F.67
9004330000	H1,0/14D R BD	F.68
9004340000	H1,5/14 R BD	F.67
9004350000	H1,5/14D SW BD	F.68
9004360000	H2,5/14D BL BD	F.67
9004370000	H2,5/14T GR BD	F.70
9004390000	H0,34/12 TK BD GSP	F.67
9004410000	H1,5/16 ZH R SV	F.72
9004420000	H1,5/16D ZH SV SV	F.73
9004430000	H2,5/19D ZH BL SV	F.72
9004440000	H0,5/14 ZH OR SV	F.72
9004500000	WAW 1 NEUTRAL	F.43
9004510000	WAW 2	D.172
9004560000	H0,5/14S OR	F.76
9004590000	H0,5/14S W	F.76
9004710000	H10,0/26D R ZH SV	F.73
9004720000	H6,0/23D ZH GE SV	F.73
9004730000	H4,2/22D ZH GR SV	F.72
9004740000	H2,5/21D ZH BL SV	F.72
9004750000	H1,5/20D SW ZH SV	F.73
9004760000	H1,0/19D ZH R SV	F.73
9004770000	H0,75/16D ZH GR SV	F.73
9004780000	H0,5/14D ZH W SV	F.73
9004900000	H0,75/16 ZH W SV	F.72
9004910000	H1,0/19 ZH GE SV	F.72
9004920000	H1,5/20 ZH R SV	F.72
9004930000	H6,0/23 ZH SV SV	F.72
9004940000	H10,0/24 ZH EB SV	F.72
9005000000	STRIPAX	F.48
9005140000	H0,75/16T ZH HBL SV	F.74
9005150000	H2,5/21 ZH GR SV	F.74
9005160000	H6,0/23T ZH GN SV	F.74
9005170000	H10,0/26T ZH BR SV	F.74
9005180000	H0,14/10 GR SV	F.66
9005610000	STRIPAX 16	F.48
9005810000	H0,5/14 OR BD GSP	F.67
9005820000	H0,75/14 W BD GSP	F.67
9005830000	H1,0/14 GE BD GSP	F.67
9005840000	H1,5/14 R BD GSP	F.67
9005850000	H2,5/14D BL BD GSP	F.67
9005860000	H0,5/14D W BD GSP	F.69
9005870000	H0,75/14D GR	F.69
9005880000	H1,0/14D R BD GSP	F.69
9005890000	H1,5/14D SW BD GSP	F.69
9005900000	H0,75/14T BL BD GSP	F.71
9005910000	H2,5/14T GR BD GSP	F.71
9005990000	PZ 1,5	F.65
9006020000	SWIFTY	F.54
9006060000	SWIFTY SET	F.54
9006120000	CTI 6	F.65
9006450000	PZ 50	F.53
9006590000	H1,5/17,5X SW SV	F.75
9006630000	H1,5/19,5X SW SV	F.75
9006670000	H2,5/17,5X BL SV	F.75
9006710000	H2,5/21,5X BL SV	F.75
9006750000	H4,0/19,5X GR SV	F.75
9006790000	H6,0/23,0X GE SV	F.75
9006830000	H10,0/24,0X R SV	F.75

Order No.	Type	Page
-----------	------	------

9006870000	H16,0/25,5X BL SV	F.75
9007440000	DMS 3	F.64
9007450000	AKKU DMS 3	F.64
9007460000	LADEGERAET DMS 3	F.64
9007470000	DMS 3 SET 1	F.64
9007480000	DMS 3 SET 2	F.64
9008320000	SD 0,5x3,0x80	F.57
9008330000	SD 0,6x3,5x100	F.57
9008340000	SD 0,8x4,0x100	F.57
9008350000	SD 1,0x5,5x150	F.57
9008370000	SDI 0,4x2,5x75	B.30
9008390000	SDI 0,6x3,5x100	D.96
9008400000	SDI 0,8x4,0x100	D.76
9008520000	SDK P20	F.57
9008530000	SDK P21	F.57
9008540000	SDK P22	F.57
9008550000	SDK P23	F.57
9008640000	SDIZ 0,8X5,5 150/248	D.76
9008850000	SK WSD-S 1,5-10,0	F.58
9008860000	SKS 2,0-8,0	F.58
9008870000	SKS 2,0-8,0 MR	F.58
9008880000	TH S 9-40	F.58
9009010000	SD 1,2x6,5x150	F.57
9009020000	SD 0,8x4,5x125	F.57
9009030000	SD 0,4x2,5x75	F.57
9009070000	SK 10,0x125	F.57
9009160000	SD TH20	F.57
9009730000	SDIS 2,5-5,5/PH1/2	F.55

9010000000

9010110000	SD 0,6x3,5x200	F.57
90111460000	PZ 6/5	F.50
9012500000	PZ 4	F.50
9012600000	PZ 16	F.52
9013600000	PZ ZH 16	F.52
9013650000	PZ 6 HEX	F.65
9014350000	PZ 6 Roto	F.51
9014400000	HTI 15	F.65
9014940000	HTF ZRV	C.94
9018510000	H0,75/14 ZH W SV	F.72
9018520000	H0,75/14D ZH GR SV	F.73
9018530000	H1,0/15 ZH GE SV	F.72
9018540000	H1,0/15D ZH R SV	F.73
9018550000	H0,75/14TS HBL	F.76
9018560000	H1,0/14S R	F.76
9018580000	H2,5/19T ZH GR SV	F.74
9018590000	H4,0/22T ZH OR SV	F.74
9018650000	H1,0/15S ZH GE SV	F.72
9018690000	H1,0/15S ZH GE	F.72
9018860000	H10/24S ZH EB	F.72
9018870000	H10/30S ZH EB	F.72
9018880000	H10,0/24DS ZH R	F.73
9018890000	H10/30DS ZH R	F.73
9018910000	H0,25/5	F.77
9019000000	H0,5/12D W	F.68
9019010000	H0,5/14D W	F.68
9019020000	H0,5/16D W	F.68
9019030000	H0,75/12D GR	F.68
9019040000	H0,75/14D GR	F.68
9019050000	H0,75/16D GR	F.68
9019060000	H0,75/18D GR	F.68
9019070000	H1,0/12D R	F.68
9019080000	H1,0/14D R	F.68
9019100000	H1,0/16D R	F.68
9019110000	H1,0/18D R	F.68
9019120000	H1,5/14D SW	F.68
9019130000	H1,5/16D SW	F.68
9019140000	H1,5/18D SW	F.68
9019150000	H1,5/24D SW	F.68
9019160000	H2,5/15D BL	F.66
9019170000	H2,5/19D BL	F.66
9019180000	H2,5/25D BL	F.66
9019190000	H4,0/18D GR	F.66
9019200000	H4,0/20D GR	F.66
9019210000	H4,0/26D GR	F.66
9019220000	H6,0/20D GE	F.68
9019230000	H6,0/26D GE	F.68
9019240000	H10,0/22D R	F.68
9019250000	H10,0/28D R	F.68
9019260000	H16,0/22D BL	F.68
9019270000	H16,0/28D BL	F.68
9019280000	H25,0/30D 16 GE	F.68
9019300000	H25,0/36D GE	F.68
9019310000	H35,0/30D 16 R	F.68
9019320000	H35,0/32D R	F.68
9019330000	H35,0/39D R	F.68
9019340000	H50/36D BL	F.68
9019350000	H50,0/41D BL	F.68
9019400000	H0,5/14D W SV	F.68
9019410000	H0,75/14D GR SV	F.68
9019420000	H1,0/14D R SV	F.68
9019430000	H1,5/14D SW SV	F.68

9020000000

9020000000	STRIPAX PLUS 2.5	F.49
9021010000	H0,25/10T GE	F.70
9021020000	H0,25/12T GE	F.70

Order No.	Type	Page
-----------	------	------

9021030000	H0,75/12T HBL	F.70
9021040000	H0,75/14 HBL	F.70
9021050000	H0,75/16T HBL	F.70
9021060000	H0,75/18T HBL	F.70
9021070000	H2,5/16T GR	F.70
9021080000	H2,5/19T GR	F.70
9021090000	H2,5/25T GR	F.70
9021100000	H4,0/18T OR	F.70
9021110000	H4,0/20T OR	F.70
9021120000	H4,0/26T OR	F.70
9021130000	H6,0/20T GN	F.70
9021140000	H6/26T GN	F.70
9021150000	H10,0/22T BR	F.70
9021160000	H10,0/28T BR	F.70
9021170000	H16,0/22T W	F.70
9021180000	H16,0/28T W	F.70
9021190000	H25,0/30T SW	F.70
9021200000	H25,0/36T SW	F.70
9021210000	H0,25/10T GE SV	F.70
9021220000	H0,25/12T GE SV	F.70
9021230000	H0,75/14T HBL SV	F.70
9021240000	H2,5/15T GR SV	F.70
9021250000	H4,0/18T OR SV	F.70
9025240000	H1,5/14S SW	F.76
9025690000	H1,5/12S R	F.76
9025700000	H0,75/14S W SV	F.76
9025710000	H1,0/14S GE SV	F.76
9025720000	H1,5/14S R SV	F.76
9025740000	H0,25/10 HBL	F.66
9025750000	H0,34/10 TK	F.66
9025760000	H0,25/12 HBL	F.66
9025770000	H0,34/12 TK	F.66
9025780000	H0,25/12 HBL SV	F.66
9025790000	H0,34/12 TK SV	F.66
9025850000	CRIMP-SET PZ 16	B.53
9025860000	H0,75/16 W	F.66
9025870000	H0,5/16 OR	F.66
9025880000	H50,0/22	F.77
9025910000	H0,75/18 W	F.66
9025930000	H1,0/18 GE	F.66
9025950000	H1,0/16 GE	F.66
9025960000	H0,75/14S W	F.76
9025970000	H1,0/14S GE	F.76
9025980000	H1,5/14S R	F.76
9026010000	H4,0/18 GR SV	F.66
9026030000	H0,34/10 TK SV	F.66
9026050000	H0,25/10 HBL SV	F.66
9026060000	H0,5/14 OR SV	F.66
9026070000	H0,75/14 W SV	F.66
9026080000	H1,0/14 GE SV	F.66
9026090000	H1,5/14 R SV	F.66
9026100000	H2,5/15 BL SV	F.66
9028200000	H70,0/37 GE	F.66
9028210000	H95,0/44 R	F.66
9028220000	H120,0/50 BL	F.66
9028230000	H150,0/54 GE	F.66
9028240000	H0,14/12 GR SV	F.66
9028250000	H0,14/10T BR SV	F.70
9028260000	H0,5/12 OR SV	F.66
9028270000	H0,5/16 OR SV	F.66
9028280000	H0,75/12 W SV	F.66
9028290000	H0,75/16 W SV	F.66
9028300000	H0,75/18 W SV	F.66
9028310000	H1,0/12 GE SV	F.66
9028320000	H1,0/16 GE SV	F.66
9028330000	H1,0/18 GE SV	F.66
9028350000	H1,5/16 R SV	F.66
9028360000	H1,5/14DS SW SV	F.76
9028490000	H2,5/12DS BL	F.76
9028580000	H0,75/14DS HBL	F.76
9028680000	CRIMP-SET PZ 6 ROTO	B.53

9030000000

9036200000	H2,5/12TS GR	F.76
9036220000	H2,5/16DS BL	F.76
9036240000	H120,0/32	F.77
9036250000	H150,0/32	F.77
9036260000	H185,0/32	F.77
9036290000	HOOKBLA 0,25-1,5 SW	F.78
9036300000	HOOKBLA 1,0-2,5 SW	F.78
9037160000	SD 0,4x2,0x60	F.57
9037200000	H0,5/14 ZH OR	F.72
9037210000	H0,5/16 ZH OR	F.72
9037220000	H0,5/18 ZH OR	F.72
9037230000	H0,75/14 ZH W	F.72
9037240000	H0,75/16 ZH W	F.72
9037250000	H0,75/24 ZH W	F.72
9037260000	H1,0/15 ZH GE	F.72
9037270000	H1,0/19 ZH GE	F.72
9037280000	H1,0/25 ZH GE	F.72
9037290000	H1,5/16 ZH R	F.72
9037300000	H1,5/20 ZH R	F.72
9037310000	H1,5/26 Z	

Order No.	Type	Page
9200670000	LID 1,5M4 R	F.80
9200680000	LID 2,5M5 R	F.80
9200690000	LID 6M5 R	F.80
9200700000	LID 1,5F4 RF	F.80
9200710000	LID 2,5F5 RF	F.80
9200720000	LID 6,0F5 RF	F.80
9201040000	HTF AFK 2.5	C.95
9201610000	WQV PEN 50N	D.30
9201630000	WQV PEN 95N/120N	D.31
9202040000	KT 45 R	F.46
9202060000	KT 55	F.46
9202510000	WK 1/4" C6,3 E6,3	F.61
9202820000	H0,75/19S ZH W	F.72
9202830000	H0,75/19DS ZH GR	F.73
9202840000	H0,75/19TS ZH HBL	F.74
9202850000	CTI 6 G	F.65
9202870000	H1,5/24 XS SW	F.75
9202880000	H2,5/24 XS BL	F.75
9202900000	H 0,5/16 S DR	F.76
9202910000	H0,5/16 DS W	F.76
9203620000	H 10,0/22 S EB	F.76
9203630000	H 4,0/20 DS GR	F.76
9204090000	H0,34/11 S TK	F.76
9204180000	AMF 6/10	F.47
9204190000	AM 16	F.47
9204240000	H0,75/15S HBL	F.76
9204250000	ERME AMF 6/10	F.47
9204260000	ERME AM 16	F.47
9204270000	ERME KT 45 R	F.46
9204280000	ERME KT 55	F.46
9205650000	SDIS 2.0-6.5	F.55

9420000000

9426770000	H2,5/14TS GR	F.76
------------	--------------	------

9450000000

9451000000	H35,0/30S	F.77
------------	-----------	------

9510000000

9512190000	WDU 70N/35	D.13
9512200000	WPE 70N/35	D.30
9512210000	WNT 70N/35	D.84
9512240000	WQV 70N/2	D.13
9512250000	WQV 70N/3	D.13
9512260000	WAD 20 GE WSD	D.176
9512420000	WDU 70N/35 BL	D.13

9520000000

9525840000	WQV 70N-PEN	D.30
9528070000	WDTR 2.5	D.59
9528080000	WDTR 2.5 BL	D.59
9528090000	WDTR 2.5/WE	D.59

9530000000

9531290000	WQV 70N/4	D.13
9532440000	KDKS 1/35 DB	D.34
9532470000	AP KDKS1 DB	D.34
9537400000	WDU 10 SL SW	D.87
9537410000	WDU 10 SL/EN SW	D.89
9537430000	WDU 6 SL/EN SW	D.88
9537440000	WDU 4 SL	D.86
9537450000	WDU 4 SL/EN	D.88
9537460000	WDU 6 SL	D.86
9537470000	WDU 6 SL/EN	D.88
9537480000	WDU 10 SL	D.87
9537490000	WDU 10 SL/EN	D.89
9537510000	WDU 4 SL/EN SW	D.88
9537550000	SIHA 1/G20	D.177
9537560000	SIHA 1/G20 10-36V	D.177
9537680000	SIHA STRAP	D.177
9537910000	AP AKZ4 DB	D.158
9538080000	WTL 6 SL/EN	D.69
9538090000	WTD 6 SL	D.91
9538100000	WTD 6 SL/EN	D.69
9538110000	WAP WTL6 SL	D.158

9540000000

9540000000	ZEW 35	F.12
------------	--------	------

9910000000

9918130000	CROSS-KEY UNIVERSAL	F.63
9918140000	CROSS-KEY UNIVERSAL S	F.63
9918150000	CROSS-KEY MASTER	F.63
9918370000	DMS MANUELL 0,5-1,7	F.61
9918380000	DMS MANUELL 2,0-8,0	F.61
9918390000	DMSI MANUELL 0,5-1,7	F.62
9918400000	DMSI MANUELL 2,0-8,0	F.62
9918410000	WK SI 0,4x2,5	F.62
9918420000	WK SI 0,5x3,0	F.62
9918430000	WK SI 0,6x3,5	F.62
9918440000	WK SI 0,8x4,0	F.62
9918450000	WK SI 1,0x5,5	F.62

Order No.	Type	Page
9918460000	WK IK PH0	F.62
9918470000	WK IK PH1	F.62
9918480000	WK IK PH2	F.62
9918490000	WK IK PZ0	F.62
9918500000	WK IK PZ1	F.62
9918510000	WK IK PZ2	F.62
9918520000	WK S 0,4x2,5	F.61
9918530000	WK S 0,5x3,0	F.61
9918540000	WK S 0,6x3,5	F.61
9918550000	WK S 0,8x4,0	F.61
9918560000	WK S 1,0x5,5	F.61
9918570000	WK K PH0	F.61
9918580000	WK K PH1	F.61
9918590000	WK K PH2	F.61
9918600000	WK K PZ0	F.61
9918610000	WK K PZ1	F.61
9918620000	WK K PZ2	F.61
9918700000	TSLD 5	F.45

Addresses worldwide

- AE United Arab Emirates**
Weidmüller Middle East FZE
P.O. Box 8591
SAIF-Zone
Sharjah U. A. E.
Phone +971 6 5572723
Fax +971 6 5572724
wme.info@weidmueller.com
- AR Argentina**
CPI SA
Bauness 2660
1431 Buenos Aires
Phone +54 11 45238008
Fax +54 11 45220546
info@cpi.com.ar
www.cpi.com.ar
- AT Austria**
Weidmüller GmbH Austria
Straße 2, Industriezentrum Nö
Süd Straße 2b M59
2355 Wiener Neudorf
Phone +43 2236 6708-0
Fax +43 2236 6708-199
office.at@weidmueller.com
- AU Australia**
Weidmüller Pty. Ltd.
P.O.Box 6944
Huntingwood Drive 43
Huntingwood,
NSW, 2148
Phone +61 2 9671-9999
Fax +61 2 9671-9911
info@weidmuller.com.au
www.weidmuller.com.au
- AZ Azerbaijan**
West Industries Ltd.
Caspian Plaza, 5-th Floor
44 J. Jabbarly Str., Baku
Phone +99412 499 15 15
Fax +99412 499 14 93
sales@west-i.com
- BA Bosnia and Herzegovina**
BH ES ELEKTROSISTEM d.o.o.
Bul. Vojvode S.
Stepanovica kod br. 272
78000 BiH - Banja Luka
Phone +387 51 420-340
Fax +387 51 420-341
elsist@inecco.net
www.elektrosistem.ba
- BE Belgium**
Weidmüller Benelux B.V.
Mechelsesteenweg 519 bus 6 en 7
1930 Nessegem
Phone +32 2 752 4070
Fax +32 2 751 3606
info@weidmueller.be
www.weidmueller.be
- BG Bulgaria**
Weid-Bul EOOD
1756 Sofia
13, bul. „Kliment Ohridski“
Phone +359 2 9632560
Fax +359 2 9631098
sofia@weidbul.com
www.weidbul.com
- BH Bahrain**
Khayber Trading Company
P.O. Box 1976 Manama,
Phone +973 720747
Fax +973 720331
khayber@batelco.com.bh
- BR Brazil**
Weidmüller Conexel do Brasil
Conexões Elétricas Ltda.
Rua Garcia Lorca, 176
09695-900, Sao Paulo SP
Phone +55 11 43669600
Fax +55 11 43621677
vendas@conexel.com.br
www.conexel.com.br
- BY Belarus**
Technikon Ltd.
Nezavisimosti pr.177-9
Minsk 220125
Phone +375 17 3931177
Fax +375 17 3930080
wm@technikon.by
- CA Canada**
W Interconnections Canada Ltd.
10 Spy Court, Markham,
Ontario L3 R5 H6
Phone +1 905 475-1507
Fax +1 905 475-2798
info1@weidmuller.ca
www.weidmuller.ca
- CH Switzerland**
Weidmüller Schweiz AG
Rundbuckstraße 2
8212 Neuhausen am Rheinfall
Phone +41 52 6740707
Fax +41 52 6740708
info@weidmueller.ch
www.weidmueller.ch
- CL Chile**
Felipe Bahamondes S.A./ATS AGRO
Maria Luisa Santander 0475
Casilla 3425
Santiago
Phone +56 2 341-1271
Fax +56 2 341-1275
felipe@atsintech.com
- CH**
Chile
CPI CHILE LTDA
Av. Presidente Frei Montalva 6001-47
Conchali - Region Metropolitana -
Santiago
cpi@cpichile.cl
- CN China**
Weidmüller Interface International
Trading (Shanghai) Co., Ltd.
25F, BM Intercontinental Business
Center,
100 Yutong Road, Shanghai 200070
P.R. China
Phone +86 21 22195008
Fax +86 21 22195009
www.cnweidmuller.com
- CO Colombia**
Automatización Avanzada S. A.
Carrera 97 No.24c, 23 B4
4 Bogotá D. C.
Phone +57 1 5478510
Fax +57 1 4223044
comercial@
automatizacionavanzada.com
www.automatizacionavanzada.com
- CR Costa Rica**
ELVATRON S.A.
la Uruca 400 Norte
Banco Costa Rica
San José Costa Rica
Phone +506 2 961060
Fax +506 5 200009
dirk.haase@elvatron.com
www.elvatron.com
- CZ Czech Republic**
Weidmüller s. r. o.
Lomnického 5/1705
14000 Praha 4
Phone +420 2 44001400
Fax +420 2 44001499
office@weidmueller.cz
www.weidmueller.cz
- DE Germany**
Weidmüller GmbH & Co. KG
P.O. Box 3054
32720 Detmold
Ohmstraße 9
32758 Detmold
Phone +49 5231 1428-0
Fax +49 5231 1428-116
weidmueller@weidmueller.de
www.weidmueller.de
- DK Denmark**
Wexoe A/S
Lejrvej 31
3500 Vaerloese
Phone +45 45465800
Fax +45 45465801
wexoe@wexoe.dk
www.wexoe.dk
- EC Ecuador**
Elsystec S. A. Electricidad
Sistemas y Tecnología
Vasco de Contreras N35-25
y Mañosa, Quito
Phone +593 2 2456510
Fax +593 2 2456755
Elsystec@uio.satnet.net
- EE Estonia**
Soots Interface OÜ
Pärnu mnt 142
11317 Tallinn
Phone +372 5296177
Fax +372 6096933
info@sootsinterface.ee
www.sootsinterface.ee
- EG Egypt**
Standard Electric (OMEGA)
87, Mohamed Farid Street
Heliopolis, Cairo
Phone +20 26422977
Fax +20 26422955
stdelec@rite.com
- ES Spain**
Weidmüller S. A.
Narcis Monturiol 11-13
Pol. Ind. Sudoeste
08960 Sant Just Desvern
Barcelona
Phone +34 93 4803386
Fax +34 93 3718055
weidmuller@weidmuller.es
www.weidmuller.es
- FI Finland**
Finland
JUHA-ELEKTRO OY
P. O. Box 57, 641 Helsinki
Kylvöpolku 6, 680 Helsinki
Phone +358 10 8326 100
Fax +358 10 8328 109
info@juha-elektro.fi
www.juha-elektro.fi
- FR France**
Weidmüller E. U. R. L.
12, Chaussée Jules César
B.P. 263 Osny
95523 Cergy Pontoise Cedex
Phone +33 1 34245500
Fax +33 1 34245501
mail@weidmuller.fr
- GB Great Britain**
Weidmüller Ltd
Klippon House
Centurion Court Office
Meridian East, Meridian Business Park
Leicester, LE19 1TP
Phone +44 1162 823470
Fax +44 1162 893582
marketing@weidmuller.co.uk
www.weidmuller.co.uk
- GR Greece**
Electrorama S.A.
1 An. Martali Str.
41335 Larissa
Phone +30 2410 552533188
Fax +30 2410 283463189
valvizes@electrorama.com.gr
- GR**
Greece
GA Contact Solutions
11, Ippokratous Str.
14452 Metamorfofi Attika
Phone +30 210 2823233
Fax +30 210 2823233
gasaless@gmail.com
- HK Hong Kong**
Weidmüller (Hong Kong) Limited
Unit 1617, The Metropolis Tower,
No.10, Metropolis Drive, Hungghom,
Kowloon
Phone +852 31548082
Fax +852 31548099
info-hk@weidmueller.de
Hong Kong
- HR Croatia**
Elektro Partner d.o.o.
Slavonska Avenija 24/6
10000 Zagreb
Phone +385 1 6184793
Fax +385 1 6184795
elektropartner@zg.t-com.hr
- HU Hungary**
Weidmüller Kft
Gubacsi út 6
1097 Budapest
Phone +36 1 3827700
Fax +36 1 3827701
info@weidmueller.hu
- ID Indonesia**
PT. Nego Electrindo
Ruko Mega Grosir Cempaka Mas, Blok
I No 20 – 22
Jl. Let.Jend. Suprato –
Jakarta 10640
Phone +62 21 42882255
Fax +62 21 42882266
sales@negoelectrindo.co.id
- IE Ireland**
Please contact Weidmüller Ltd. in
Great Britain
- IL Israel**
A.U.Shay Ltd.
P.O. Box 10049
Embar Street 23/25
49222 Petah-Tikva
Phone +972 3 9243273
Fax +972 3 9233601
- IS**
Israel
ATEKA Ltd.
23 Hayetzira
St. Kiryat Aryeh
49130 Petah-Tikva
Phone +972 3 9392344
Fax +972 3 9243273
marketing@ateka.co.il
www.ateka.co.il
- IN India**
Weidmüller Electronics India Pvt. Ltd
Plot # 32, 3rd Floor, North Court
Lane North Avenue, Opp Jogger's Park
Kalyani Nagar, Maharashtra
411006 Pune
Phone +91 9049800960
Nitish.Rajan@weidmueller.de
- IR Iran**
Tamin Ehtiajat Fani Tehran (TAF Co.)
72, Iranshahr Ave.(Unit # 5)
15816 Tehran
Phone +98 21 8831-7851
Fax +98 21 8882-0268
tafco@safineh.net
- IS Iceland**
Samey Automation Center
Lyngas 13, 210 Garoabaer,
Phone +354 510 5200
Fax +354 510 5201
samey@samey.is
- IT Italy**
Weidmüller S.R.L.
Via Albert Einstein 4
20092 Cinisello Balsamo
Milano
Phone +39 02 660681
Fax +39 02 6124945
weidmuller@weidmuller.it
www.weidmuller.it
- JO Jordan**
HORIZONS
P.O.Box: 330607
Amman Jordan 11133
Phone +962 6 4882114
Fax +962 6 4882115
horizons@go.com.jo
- JP Japan**
Nihon Weidmüller Co. Ltd.
Sphere Tower Tennoz,
2-2-8 Higashi-Shinagawa,
Shinagawa-Ku, Tokyo 140-0002
Phone +81 3 6711-5300
Fax +81 3 6711-5333
www.weidmuller.co.jp
- KR Korea**
Weidmüller Korea Co., Ltd.
6ffloor, Sukyoung building, 242-54
Nohunyun-dong, Kangnam-Gu
Seoul, Korea
Zip: 135-830
Phone +82 2 5160003
Fax +82 2 5160090
info@weidmuller.co.kr
- KW Kuwait**
KANACONROLS General
Trading & Cont. Co. W.L.L.
Al Rai Industrial Area,
Plot 28-30, St. 31
P.O.Box: 25593
Safat, 13016
Phone +966-474 1373/4
Fax +966-474 1537
info@kanacontrols.com

Group companies Agency abroad Without own Agency 

- LB Lebanon**
Progress Engineering & Trading Enterprises
Al Nahr Street
Beirut
Phone +961 1 444664
Fax +961 1 561880
progress@inco.com.lb
- LT Lithuania**
ELEKTROS IRANGA
Tinklu g.29a, 5319 Panevezys
Phone +370 45582828
Fax +370 45582727
info@eliranga.lt
- LU Luxembourg**
Please contact Weidmüller
Benelux B.V. in the Netherlands
- LV Latvia**
SIA „AB14“
Daugavgrivas str. 31b
1007 Riga
Phone +371 67470999
Fax +371 67465637
abi_4@tvnet.lv
- MD Moldova**
BERHORD A&D srl
44, srt. Sarmizegetusa 37/3
Off 414, b-dul Decebal, 3,
Chisinau, MD 2001
Phone +373 22 507137
Fax +373 22 507134
atituleanu@berhord.com
- ME Montenegro**
Please contact
ES-YU Elektrosistem in Serbia
- MK Macedonia**
ELEKTRO – SMK doool
UL. III Makedonska brigada b.b.
1000 Skopje
Phone +389 22 460 295
Fax +389 22 460 298
Elektro-smk@telekabel.net.mk
- MT Malta**
E. S. S., Electrical Supplies
& Services Ltd
104 J. Sciberras Str.
Hamrun HMR 08
Phone +356 21 255 777
Fax +356 21 255 999
robert@ess.com.mt
- MU Mauritius**
MUBELO Electrical Ltd
Office 26, Gateway building,
St-Jean Road, Quatre Bornes
Phone +230 467 0989
Fax +230 465 4051
richard.mubelo@orange.mu
- MX Mexico**
W Interconnections, S.A. DE C.V.
Blvd. Hermanos Serdán No. 698
Col. San Rafael Oriente
Puebla, C.P. 72029
Phone +52 222 22686227
clientes@weidmuller.com.mx
- MY Malaysia**
Connect Plus Technology Sdn Bhd
No. 43, Jalan PJS 11/22,
Bandar Sunway, 46150 Petaling Jaya
Selangor Darul Ehsan
Phone +60 3 5633 7363
Fax +60 3-5633 6562
paul@cptech.com.my
www.cptech.com.my
- NL Netherlands**
Weidmüller Benelux B.V.
Franciscusweg 221
1216 SE Hilversum
Postbus 1506
1200 BM Hilversum
Phone +31 35 6261261
Fax +31 35 6232044
info@weidmuller.nl
- NO Norway**
Siv. Ing. J. F. Knudtzen A/S
Billingstadsletta 97
P.O. Box 160
1378 Nesbru
Phone +47 66 983350
Fax +47 66 980955
firmapost@jfkudtzen.no
www.jfkudtzen.no
- NZ New Zealand**
Cuthbert S. Steward Limited
27 Te Puni Street
POB 38496
Petone, Wellington
Phone +64 4 5686156
Fax +64 4 5686056
info@weidmueller.de
- OM Oman**
DAN INTERNATIONAL LLC.
P.O. BOX 2901
111 Seeb
Phone +968 503 677
Fax +968 503 755
yedu@danintl.com
- PE Peru**
IMGEPRO DEL PERU S.A.C.
ca. ortiz de Zevallos 105, esquina
con vargas macucha, Miraflores,
Lima, Peru
Phone +51 1 447 5608
imgepro@gmail.com
www.imgepro.com.pe
- Peru**
J & W CIA. S.A.
Calle 6 Mz. D Lte. 23
Urb. Ind. Grimanesa
Callao 01
Phone +51 1 57 22539
Fax +51 1 57 20152
lespinoza@jwcia.com
www.jwcia.com
- PH Philippines**
Enclosure Systems Specialists Inc
Room 103 Narra Building
2276 Don Chino Rocas Avenue
Makati City 1231
Phone +63 2 813 8580
Fax +63 2 813 8596
sales_encsys@pltdtdsl.net
- PK Pakistan**
Kana Controls (Pak)
Apartment No. 33 C III
Chenab Block,
Allama Iqbal Town
Lahore, Pakistan
Phone +92 42 5419948
+92 42 7845160
Fax +92 42 5422895
nadeem@kanapak.com
www.kanapak.com
- PL Poland**
Weidmüller Sp. z o.o.
Ul. Golezdzinowska 10
03-302 Warszawa
Phone +48 22 5100940
Fax +48 22 5100941
biuro@weidmuller.com.pl
www.weidmuller.pl
- PT Portugal**
Weidmüller Sistemas de
Interface S. A.
Estrada Outeiro Polima, R. Augusto
Dias da Silva, Lote B, Esc. 2
2785-515 Abóboda -São Domingos
de Rana
Phone +351 21 4459191
Fax +351 21 4455871
www.weidmueller.pt
- QA Qatar**
Qatar
Doha Motors Trading Co.
(Technical Division)
Post Box No. 145
Airport Road
Doha - Qatar
Phone +974 465 1441
Fax +974 465 0925
dmtctech@qatar.net.qa
- RO Romania**
Rominterface Impex SRL
Str. Gh. Dem Teodorescu 30 A
30916 Bucuresti - sector 3
Phone +40 21 3220230
Fax +40 21 3228857
office@rominterface.ro
- RS Serbia**
ES-YU Elektrosistem
Pariske komune 41
11070 Novi Beograd, Serbia
Phone +381 11 3018660
Fax +381 11 2693608
esyu@eunet.rs
www.elektrosistem.co.rs
- RU Russia**
000 Weidmüller
Warshavskoye highway, 25A, bld. 6
117105 Moscow
Phone +7 4 95 771-6940
Fax +7 4 95 771-6941
info@weidmueller.ru
www.weidmueller.ru
- SA Saudi Arabia**
Al Abdulkarim Holding Co.
P.O. Box. 4
Dammam 31411
Phone +9668337110
Fax +9668338242
salehsk@akh.com.sa
www.akte.com.sa
- Saudi Electric Supply Co.**
P.O. Box 3298
Al Khobar 31952
Phone +966 3 882 9546227
Fax +966 3 882 9547
Safdar.malik@sesco-ge.com
- SE Sweden**
Weidmüller AB
Axel Daniéssons väg 271
P.O. box 31025
200 49 Malmö
Phone +46 (0) 7 71 43 00 44
Fax +46 (0) 40 37 48 60
info@weidmuller.se
www.weidmuller.se
- SG Singapore**
Weidmüller Pte. Ltd.
70 Bendemeer Road
#04-03 Luzerne
Singapore 339940
Phone +65 6841 5311
Fax +65 6841 5377
info@weidmuller.com.sg
www.weidmuller.com.sg
- SI Slovenia**
Elektrospoji d.o.o.
Stegne 25, 1000 Ljubljana
Phone +386 15113810
Fax +386 15111604
info@elektrospoji.si
www.elektrospoji.si
- SK Slovakia**
ELEKTRIS s.r.o.
Elektrárenská 1
83104 Bratislava
Phone +421 2 49200113
Fax +421 2 49200119
bratislava@elektris.sk
- TH Thailand**
Pisanu Engineering Co., Ltd
800/43-45 Soi Trakulsuk
Asoke-dindaeng Road,
Dindaeng, Bangkok 10400
Phone +66 2 245 9113
Fax +66 2 6429220
jayasankar@pisanu.co.th
www.pisanu.co.th
- TN Tunisia**
Please contact
Weidmüller E.U.R.L. in France
- TR Turkey**
Weidmüller Elektronik Ticaret Ltd.
Sirketi
Kavacik Mah. Orhan Veli Kanik
Caddesi 9/1
34810 Beykoz – Istanbul
Phone +90 216 5371070 (Pbx)
Fax +90 216 5371077
info@weidmuller.com.tr
www.weidmuller.com.tr
- TW Taiwan**
Fittatek Co., Ltd.
12F No. 185 Fu-Kuo Road,
Tso Ying Dist, Kaohsiung
Phone +866 7 556 0858
Fax +866 7 556 3279
stanley@fittatek.com.tw
www.fittatek.com.tw
- Taiwan**
Eucan Enterprise Ltd.
No. 145 He Ping 2nd Rd
Kaohsiung
Phone +886 7 715 6610
Fax +886 7 715 8748
mark@eucan.com.tw
www.eucan.com.tw
- UA Ukraine**
TEKO INTERFACE
Lomonosova str. 73g
03022 Kiev
Phone +38 044 3740640
Fax +38 044 3740642
weidmueller@tekointerface.com
www.tekointerface.com.ua
- US United States**
W-Interconnections Inc.
821 Southlake Boulevard,
Virginia - Richmond 23236
Phone +1 804 7942877
Fax +1 804 3792593
info@weidmuller.com
www.weidmuller.com
- UY Uruguay**
Revo Uruguay S.A
Av. Bolivia 2001 Esq Rocafuerte
Carrasco Montevideo 11300
Phone / Fax +598 260 48439
clorda@rewo Uruguay.com.uy
- UZ Uzbekistan**
OOO "Elektro Potential"
Gani Mavljanova str., 2B
100084 Tashkent
Phone +998 98-3003821
Fax +998 71-1249286
mz1958@yandex.ru
- VE Venezuela**
Somerinca C.A.
Quinta Sagrado Corazon de Jesus -
3ra Transversal - Los Dos Caminos,
Caracas 1070 - A
Phone +58 212 2352748
Fax +58 212 2399341
klcsmoeller@cantv.net
www.kmsomerinca.com.ve
- VN Vietnam**
AUMI Co., Ltd
E1, La Thanh Hotel,
218 Doi Can Street,
Lieu Giai Ward, Ba Dinh District,
Hanoi City
Phone +84 4762 8601
Fax +84 4266 1391
aumi@aumi.com.vn
- Linh Kim Hai Co., Ltd**
78 Hoa Cuc Street Ward 7,
Phu Bhuon District,
Ho Chi Minh City
Phone +84 8517 1717
Fax +84 8517 1818
lkh@linhkimhai.com.vn
- ZA South Africa**
Phambili Interface (Pty) Ltd
P.O. Box 193, 1609 Johannesburg
5 Bundo Road, Sebenza
1610 Johannesburg, Eindhovenale
Phone +27 11 452 1930
Fax +27 11 452 6455
sales@weidmuller.co.za
www.radinterface.co.za
- DE Other countries**
Weidmüller Interface GmbH & Co. KG
Postfach 3030
32720 Detmold
Klingenbergstraße 16
32758 Detmold
Phone +49 5231 14-0
Fax +49 5231 14-292083
info@weidmueller.de
www.weidmueller.com

We cannot guarantee that there are no mistakes in the publications or software provided by us to the customer for the purpose of making orders. We try our best to quickly correct errors in our printed media.

X

All orders are based on our general terms of delivery, which can be reviewed on the websites of our group companies where you place your order. On demand we can also send the general terms of delivery to you.

As experienced experts we support our customers and partners around the world with products, solutions and services in the industrial environment of power, signal and data. We are at home in their industries and markets and know the technological challenges of tomorrow. We are therefore continuously developing innovative, sustainable and useful solutions for their individual needs. Together we set standards in Industrial Connectivity.

Modular Terminal Blocks Catalogue 2012/2013

Modular Terminal Blocks

Connectivity

Catalogue 2012/2013

Weidmüller 

Weidmüller Interface GmbH & Co. KG
Klingenbergstraße 16
32758 Detmold, Germany
T +49 5231 14-0
F +49 5231 14-292083
info@weidmueller.com
www.weidmueller.com



4 050118 072501

Order number: 1282250000/03/2012/SMDM

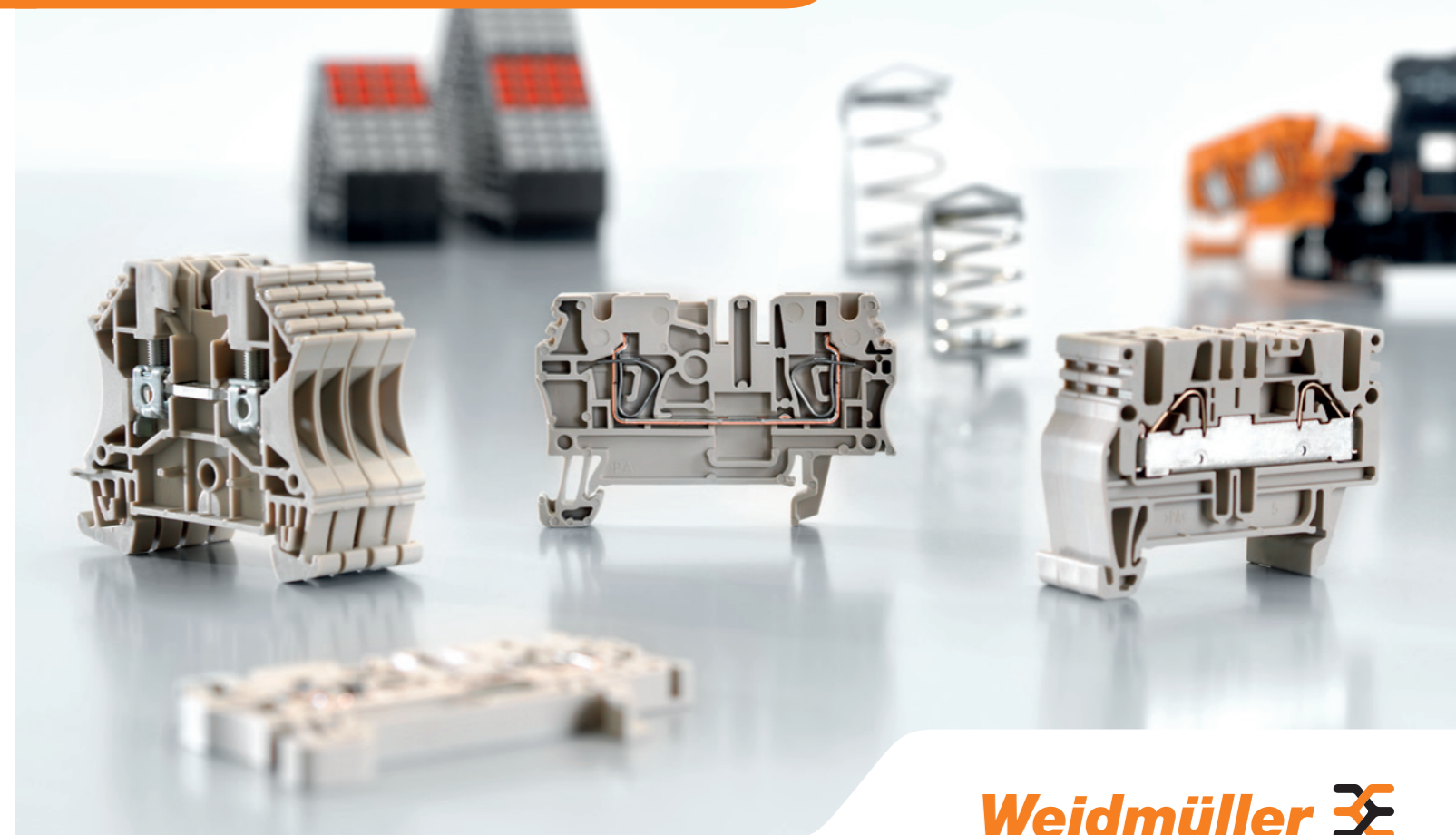

Weidmüller 

Looking for pricing, stock, or lifecycle information?

Click below to explore more details on WIN SOURCE:

 [View 1834070000 on WIN SOURCE](#)

 [Weidmuller Information](#)

Optimize Your Supply Chain with WIN SOURCE Solutions

-  Global Sourcing Solution
-  Obsolete Management
-  Cost Control Management
-  Shortage Management
-  Alternative Solution
-  Excess Inventory Management