

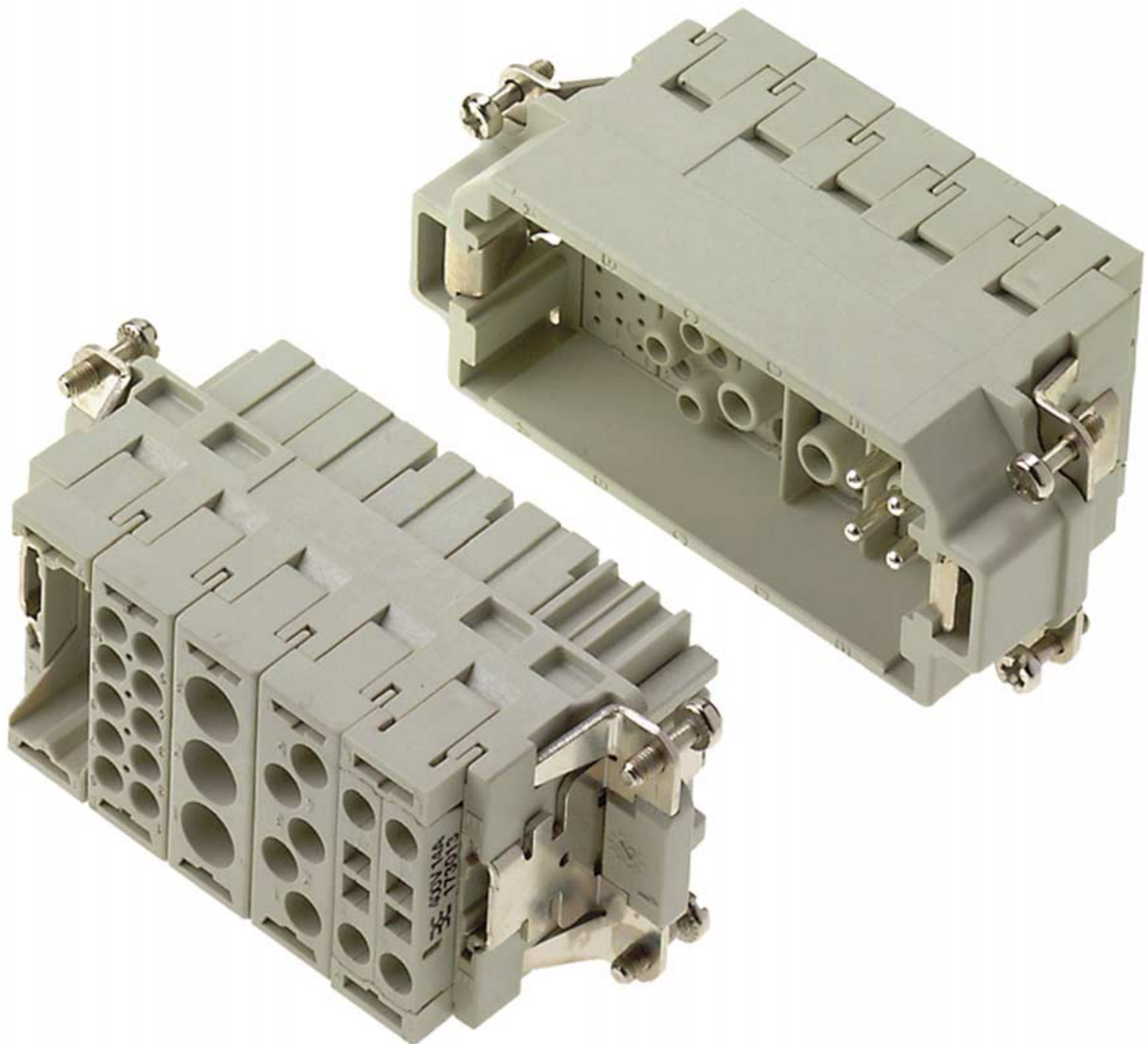

**THE DATASHEET OF  
1787000000**



## Series ConCept



## Series ConCept

### Series ConCept

- Screw connection (2-pole)
- Crimp contact (3- to 20-pole)
- Tension clamp (4-pole)
- Poles numbers: 2, 3, 4, 5, 10, 20
- Stamped or turned crimp contacts

### **Universal and flexible – the solution for a large number of applications**

The modular ConCept connector system is a low-cost alternative of the well-known and proven HE inserts with fixed poles. It provides the user with flexibility in standard applications and in applications that require customized connectors.

Weidmüller have expanded the system by a tension clamp and a crimp module that offers a free selection of the connecting technology: crimp or tension clamp.

The steadily increasing number of modules with varying numbers of poles and electrical specifications are the basis of a very high number of combination options. Six different male and female modules with different power data and connecting technology, in conjunction with the mounting frames for 2, 3, 5, or 7 modules provide variable connector combinations options.

Single or double-row frames, in combination with standard housings create a reliable connection in machines, switchgear cabinets, motors and installations.

### Benefits:

- signal and power transmission possible via the same connector
- extremely flexible due to a large number of practical combinations of modules, frames, hoods and housings
- free choice of the connecting technology in the modules
- crimp module for low-cost HE crimps
- tension clamp module for time-saving processing, maintenance-free and highly vibration-proof
- modules and frames made from a PC material without halogens or phosphorus



# ConConcept / Technical Data

	630 V/40 A	400* V/20 A	250 V/10 A	100 V/4 A	630 V/25 A	400 V/14 A	1000 V/82 A	1000 V/82 A
<b>System specifications</b>								
Pole number	3	5	10	20	4	4	1/1 PE	2
Description	CM-3	CM-5	CM-10	CM-20	CM-HE	CM-4BZF/4SZF	CM 1 + PE	CM-2
Contact diameter	3.6	2.5	1.6	1	2.5	2.5	6	6
Connection method	crimp	crimp	crimp	crimp	crimp	tension clamp	screw	screw
Contact	turned	turned	turned	stamped	turned	turned	turned	turned
<b>Conductor cross-section</b>								
mm <sup>2</sup>	1.5...10.0 <sup>2)</sup>	0.75...4.0 <sup>1)</sup>	0.14...2.5 <sup>1)</sup>	0.08...0.52 <sup>1)</sup>	0.5...4 <sup>1)</sup>	0.5...2.5 <sup>1)</sup>	4.0...16.0	4.0...16.0
AWG conductor	12...7	20...12	26...14	28...20	20...12	20...12	12...6	12...6
<b>Electrical specification plastic PC</b>								
Colour: <b>grey</b>								
Rated voltage max.	V	630	250	250	100	630	400	1000
Rated current max.	A	40	20	10	4	25	14	82
Impulse voltage	KV	8	6	4	1.5	8	6	6
Pollution severity		3	3	3	3	3	3	3
Insulation resistance	Ω >	10 <sup>12</sup>	10 <sup>12</sup>	10 <sup>11</sup>	10 <sup>12</sup>	10 <sup>12</sup>	10 <sup>12</sup>	10 <sup>12</sup>
Overvoltage category		III	III	III	III	III	III	III
Through resistance	mΩ	< 5	< 5	< 5	< 5	< 5	< 5	< 5
<b>Electrical specification plastic PA</b>								
Colour: <b>black</b>								
Rated voltage max.	V	630	400	250	100			
Rated current max.	A	40	20	10	4			
Impulse voltage	KV	8	6	4	1.5			
Pollution severity		3	3	3	3			
Insulation resistance	Ω >	10 <sup>11</sup>	10 <sup>11</sup>	10 <sup>10</sup>	10 <sup>11</sup>			
Overvoltage category		III	III	III	III			
Through resistance	mΩ	< 5	< 5	< 5	< 5			
		*400 Volt only if black modules						
<b>Materials data</b>								
• Modules								
Flammability class UL 94								V-0
Plastic material								PA/PC (grey, RAL 7032) PA (black, RAL 9005) <sup>3)</sup>
• Frames								
Flammability class UL 94								V-0
Plastic material								PC (grey, RAL 7032) PA (black, RAL 9005) <sup>3)</sup>
• Contacts								
Basic material								Cu-alloy
Plating		Ag	Ag	Ag/Au	Ag	Ag/Au	Ag	

### Application note:

Weidmüller connectors are tested according to the DIN VDE 0627 standard, and are valid for its field of applications. Provided that the connectors are used for the intended purpose, all requirements with respect to the occurring of electrical, mechanical, thermic and corrosive stress will be satisfied. Connectors are not allowed to be operated under loading.

- 1) Ferrules are required for the connection of conductors with a cross-section ≤ 0.75 mm<sup>2</sup>.
- 2) Ring tongues are required for the connection of conductors with a cross-section 6 mm<sup>2</sup> to 10 mm<sup>2</sup>.
- 3) 4-pole crimp module CM-HE and tension clamp module CM-4BZF/4SZF are only available in PC (grey).

## Module CM-3

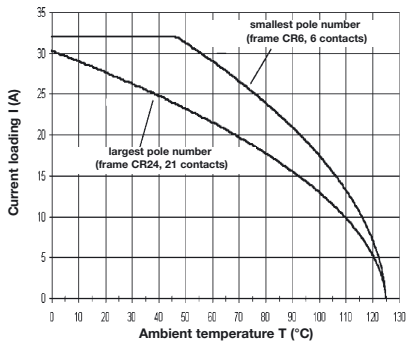

ConCept module CM-3  
Conductor H07V-K4.0 mm<sup>2</sup>

## Module CM-5

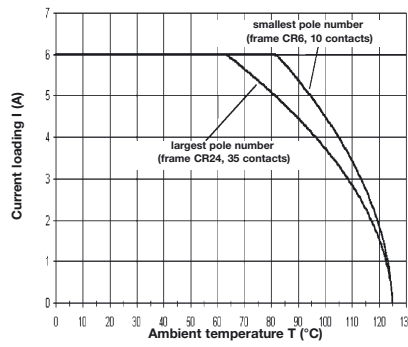

ConCept module CM-5  
Conductor H05V-K0.5 mm<sup>2</sup>

## Module CM-10

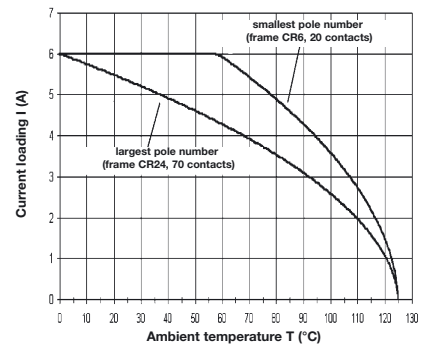

ConCept module CM-10  
Conductor H05V-K0.5 mm<sup>2</sup>

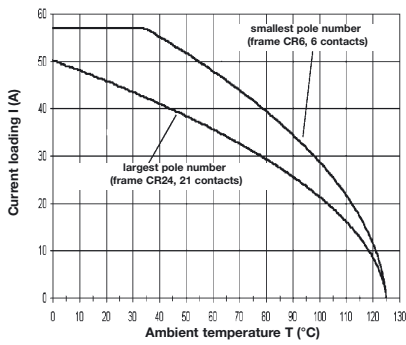

ConCept module CM-3  
Conductor H07V-K10.0 mm<sup>2</sup>

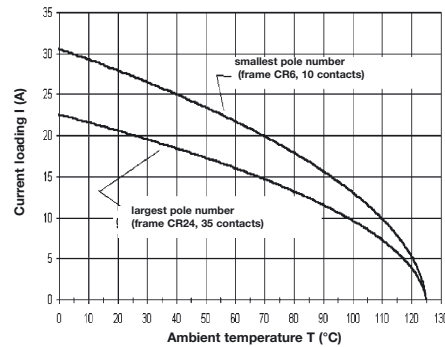

ConCept module CM-5  
Conductor H07V-K4.0 mm<sup>2</sup>

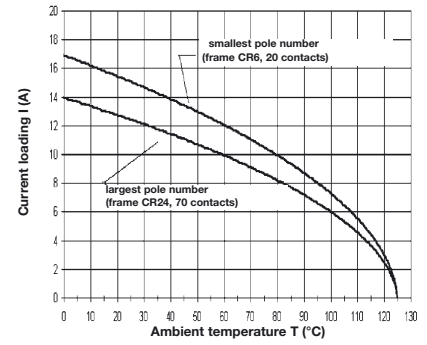

ConCept module CM-10  
Conductor H07V-K2.5 mm<sup>2</sup>

## Module CM-20

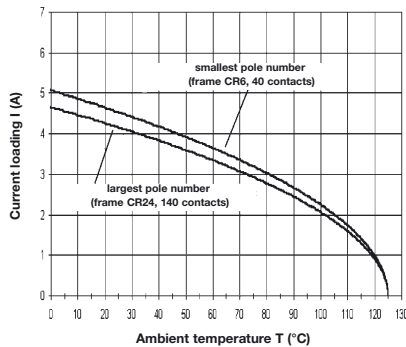

ConCept module CM-20  
AWG-Conductor 20/19

## Module CM-HE

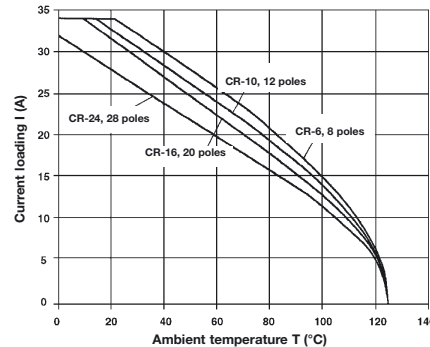

ConCept module CM-HE  
Conductor H07V-K4.0 mm<sup>2</sup>

## Module CM-4BZF/4SZF

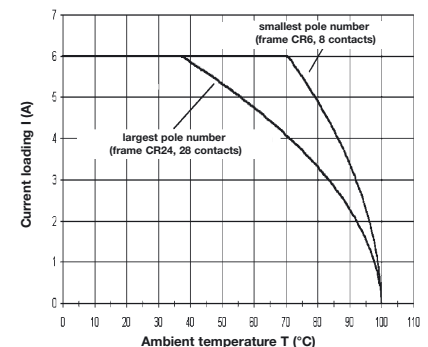

ConCept module CM-4BZF/4SZF  
Conductor H05V-K0.5 mm<sup>2</sup>

## Module CM-2

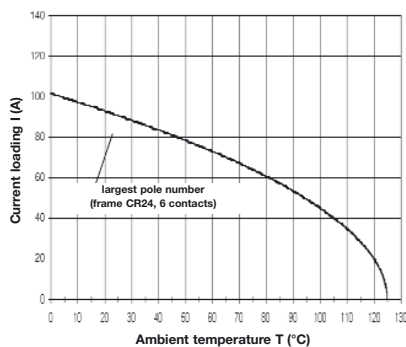

ConCept module CM-2  
Conductor 16 mm<sup>2</sup>

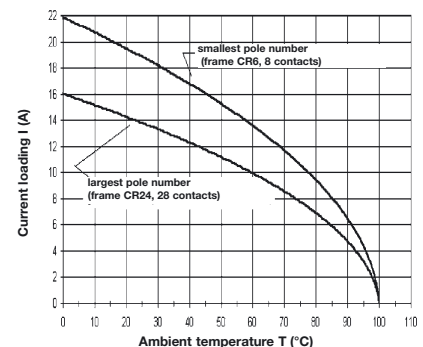

ConCept module CM-4BZF/4SZF  
Conductor H07V-K2.5 mm<sup>2</sup>

# ConCept Modules

## Crimp connection CM-3SCM

3-pole

630 V/40 A

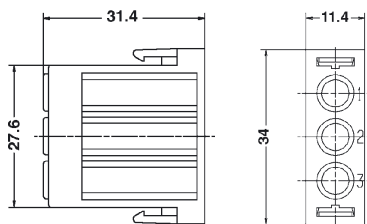

## Crimp connection CM-5SCM

5-pole

250° V/20 A

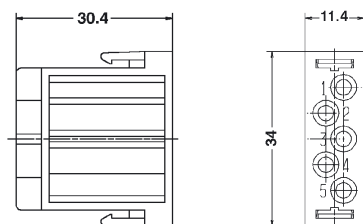

## Crimp connection CM-10SCM

10-pole

250 V/10 A

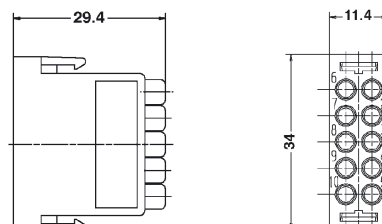

## Crimp connection CM-3BCM

3-pole

630 V/40 A

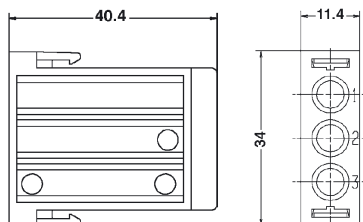

## Crimp connection CM-5BCM

5-pole

250° V/20 A

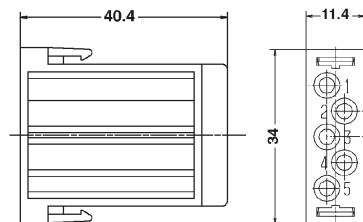

## Crimp connection CM-10BCM

10-pole

250 V/10 A

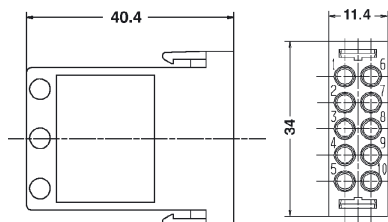

### For turned contacts

Colour		Black	Grey
Version	Type	Cat. No.	Cat. No.
Male	HDC-CM-3SCM	1682080000	1758360000
Female	HDC-CM-3BCM	1682090000	1758370000

### For turned contacts

Colour		Black	Grey
Version	Type	Cat. No.	Cat. No.
Male	HDC-CM-5SCM	1682100000	1758380000
Female	HDC-CM-5BCM	1682110000	1758390000

### For turned contacts

Colour		Black	Grey
Version	Type	Cat. No.	Cat. No.
Male	HDC-CM-10SCM	1682120000	1758400000
Female	HDC-CM-10BCM	1682130000	1758410000

\* 400 V for black modules

# ConCept Modules

## Crimp connection CM-20SCM

20-pole 100 V/4 A

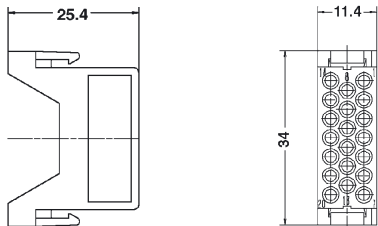

## Crimp connection CM-HE 4S GR

4-pole 630 V/25 A

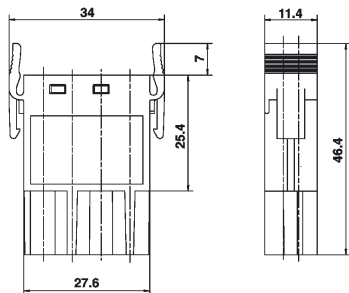

## Tension clamp CM-4SZF AG

4-pole 400 V/14 A

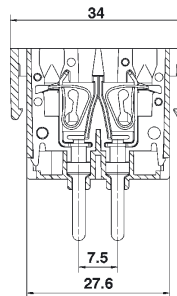

## Crimp connection CM-20BCM

20-pole 100 V/4 A

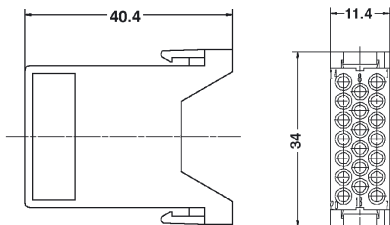

## Crimp connection CM-HE 4B GR

4-pole 630 V/25 A

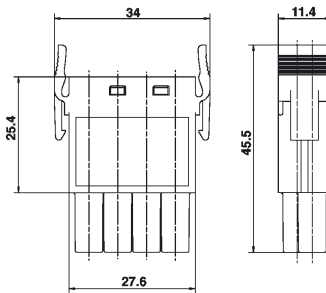

## Tension clamp CM-4BZF AG

4-pole 400 V/14 A

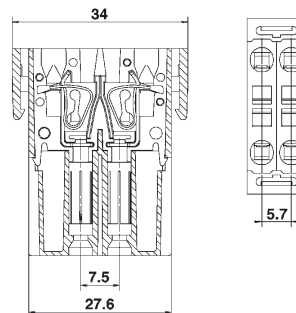

### For stamped contacts

Colour		Black	Grey	
Version	Type	Cat. No.	Cat. No.	Qty.
Male	HDC-CM-20SCM	1682160000	1758420000	10
Female	HDC-CM-20BCM	1682170000	1758430000	10

### For turned contacts

Colour		Black	Grey	
Version	Type	Cat. No.	Cat. No.	Qty.
Male	HDC-CM-HE-4S GR	1758340000		10
Female	HDC-CM-HE-4B GR	1758350000		10

Colour		Black	Grey	
Version	Type	Cat. No.	Cat. No.	Qty.
Male	HDC-CM-4SZF AG	1730120000		10
Female	HDC-CM-4BZF AG	1730130000		10

**NEW**

## ConCept Modules

### Screw connection CM-1 SS + PE

1-pole + PE

1000 V/82 A



### Screw connection CM-2 SS

2-pole

1000 V/82 A

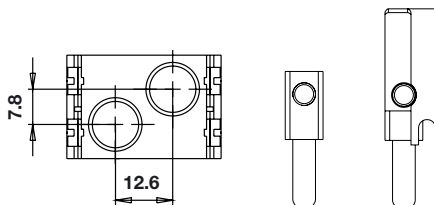
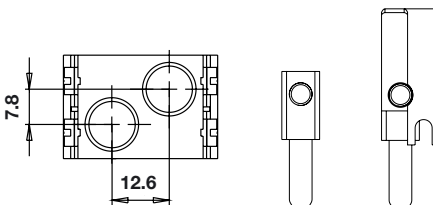
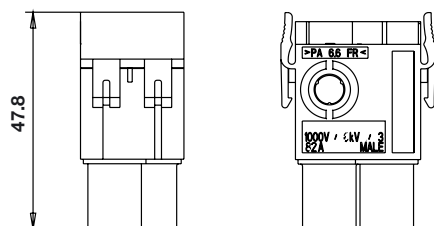
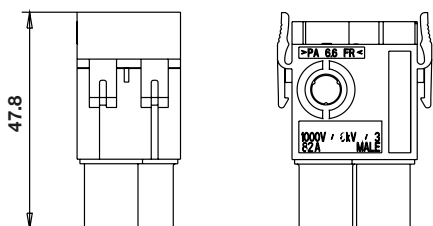

### Screw connection CM-1 BS + PE

1-pole + PE

1000 V/82 A



### Screw connection CM-2 BS

2-pole

1000 V/82 A

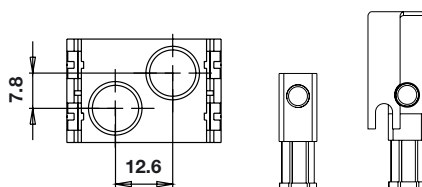
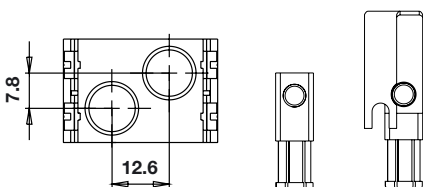
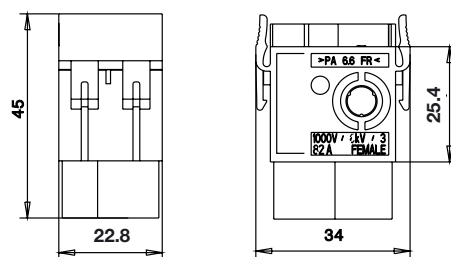
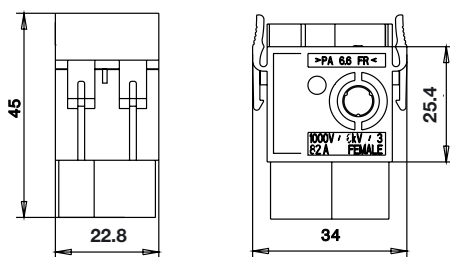

Colour		Grey	
Version	Type	Cat. No.	Qty.
Male	HDC-CM 1SS+PE	1807980000	5
Female	HDC-CM 1BS+PE	1808000000	5

Colour		Grey	
Version	Type	Cat. No.	Qty.
Male	HDC-CM 2SS	1807970000	5
Female	HDC-CM 2BS	1807990000	5

## ConCept / Crimp Contacts

**Crimp contacts** must be ordered separately. Basis of the turned and stamped contacts is a brass-alloy. Contact platings are available either in gold- or silver-plated versions. Stamped contacts are only available with gold coating. The male and female inserts are optionally available for stamped or turned contacts. Please select required crimp contacts.

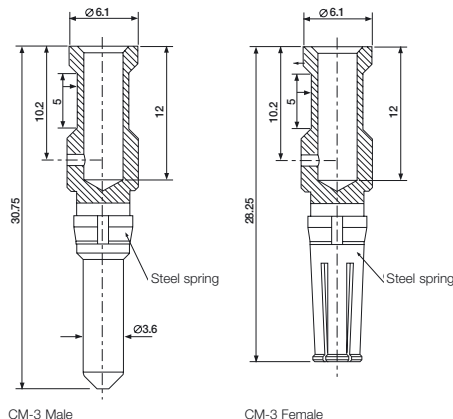

CM-3 Male

CM-3 Female

### Turned crimp contacts for module CM-3

Contact diameter of pin  $\varnothing$  3.6 mm

Cross-section mm <sup>2</sup>	AWG	Plating	Version	Type	Cat. No.	Qty.
1.5	16	Ag	Male	HDC-C-M3-SM1.5Ag	<b>1698120000</b>	100
1.5	16	Ag	Female	HDC-C-M3-BM1.5Ag	<b>1698130000</b>	100
2.5	14	Ag	Male	HDC-C-M3-SM2.5Ag	<b>1698140000</b>	100
2.5	14	Ag	Female	HDC-C-M3-BM2.5Ag	<b>1698150000</b>	100
4.0	12	Ag	Male	HDC-C-M3-SM4.0Ag	<b>1682260000</b>	100
4.0	12	Ag	Female	HDC-C-M3-BM4.0Ag	<b>1682270000</b>	100
6.0	10	Ag	Male	HDC-C-M3-SM6.0Ag	<b>1682280000</b>	100
6.0	10	Ag	Female	HDC-C-M3-BM6.0Ag	<b>1682290000</b>	100
10.0	7	Ag	Male	HDC-C-M3-SM10.0Ag	<b>1682300000</b>	100
10.0	7	Ag	Female	HDC-C-M3-BM10.0Ag	<b>1682310000</b>	100

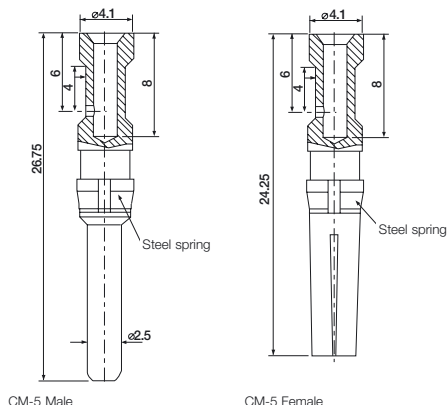

CM-5 Male

CM-5 Female

### Turned crimp contacts for module CM-5

Contact diameter of pin  $\varnothing$  2.5 mm

Cross-section mm <sup>2</sup>	AWG	Plating	Version	Type	Cat. No.	Qty.
0.75-1.0	18	Ag	Male	HDC-C-M5-SM0.75-1.0Ag	<b>1682340000</b>	100
0.75-1.0	18	Ag	Female	HDC-C-M5-BM0.75-1.0Ag	<b>1682350000</b>	100
1.5	16	Ag	Male	HDC-C-M5-SM1.5Ag	<b>1682360000</b>	100
1.5	16	Ag	Female	HDC-C-M5-BM1.5Ag	<b>1682370000</b>	100
2.5	14	Ag	Male	HDC-C-M5-SM2.5Ag	<b>1682380000</b>	100
2.5	14	Ag	Female	HDC-C-M5-BM2.5Ag	<b>1682390000</b>	100
4.0	12	Ag	Male	HDC-C-M5-SM4.0Ag	<b>1682400000</b>	100
4.0	12	Ag	Female	HDC-C-M5-BM4.0Ag	<b>1682410000</b>	100

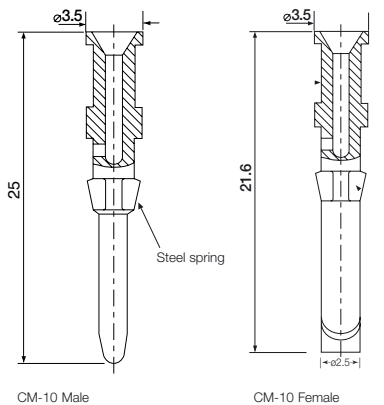

CM-10 Male

CM-10 Female

### Turned crimp contacts for module CM-10

Contact diameter of pin  $\varnothing$  1.6 mm

Cross-section mm <sup>2</sup>	AWG	Plating	Version	Type	Cat. No.	Qty.
0.14 - 0.37	26...22	Au	Male	HDC-C-HD-SM0.14-0.37Au	<b>1651620000</b>	100
		Au	Female	HDC-C-HD-BM0.14-0.37Au	<b>1651670000</b>	100
	26...22	Ag	Male	HDC-C-HD-SM0.14-0.37Ag	<b>1651520000</b>	100
		Ag	Female	HDC-C-HD-BM0.14-0.37Ag	<b>1651570000</b>	100
0.5	20	Au	Male	HDC-C-HD-SM0.5Au	<b>1651630000</b>	100
		Au	Female	HDC-C-HD-BM0.5Au	<b>1651680000</b>	100
	20	Ag	Male	HDC-C-HD-SM0.5Ag	<b>1651530000</b>	100
		Ag	Female	HDC-C-HD-BM0.5Ag	<b>1651580000</b>	100
0.75 - 1.00	18	Au	Male	HDC-C-HD-SM0.75-1.00Au	<b>1651640000</b>	100
		Au	Female	HDC-C-HD-BM0.75-1.00Au	<b>1651690000</b>	100
	18	Ag	Male	HDC-C-HD-SM0.75-1.00Ag	<b>1601750000</b>	100
		Ag	Female	HDC-C-HD-BM0.75-1.00Ag	<b>1601760000</b>	100
1.5	16	Au	Male	HDC-C-HD-SM1.5Au	<b>1651650000</b>	100
		Au	Female	HDC-C-HD-BM1.5Au	<b>1651700000</b>	100
	16	Ag	Male	HDC-C-HD-SM1.5Ag	<b>1651550000</b>	100
		Ag	Female	HDC-C-HD-BM1.5Ag	<b>1651600000</b>	100
2.5	14	Au	Male	HDC-C-HD-SM2.5Au	<b>1651660000</b>	100
		Au	Female	HDC-C-HD-BM2.5Au	<b>1651710000</b>	100
	14	Ag	Male	HDC-C-HD-SM2.5Ag	<b>1651560000</b>	100
		Ag	Female	HDC-C-HD-BM2.5Ag	<b>1651610000</b>	100

\* We recommend the mounting tool HDC-DW-M10, order no. 1688220000, for securing contacts into the insert. The contact is safely positioned in the insert when it audibly clicks into place.

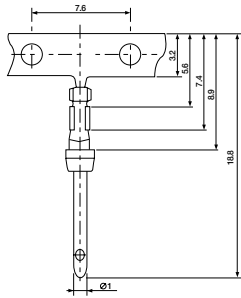

CM-20 Male

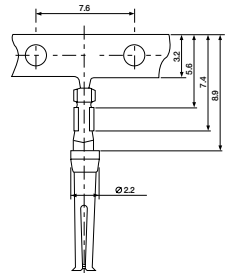

CM-20 Female

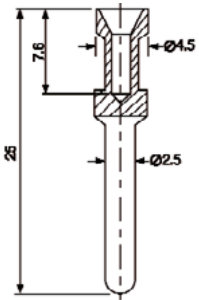

CM-HE Male

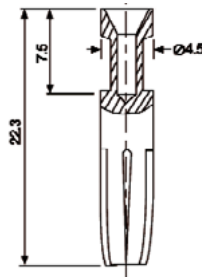

CM-HE Female

## Stamped crimp contacts for module CM-20

Contact diameter of pin Ø 1 mm

Cross-section mm <sup>2</sup>	AWG	Plating	Version	Type	Cat. No.	Qty. <sup>1)</sup>
0.08-0.2	28...24	Au	Male	HDC-C-M20-SCG0.08-0.2Au	<b>1682420000</b>	300
	28...24	Au	Female	HDC-C-M20-BCG0.08-0.2Au	<b>1682430000</b>	300
0.2-0.52	24...20	Au	Male	HDC-C-M20-SCG0.2-0.52Au	<b>1682440000</b>	300
	24...20	Au	Female	HDC-C-M20-BCG0.2-0.52Au	<b>1682450000</b>	300

1) Bandoier contacts wrapped on reel

## Turned crimp contacts for module CM-HE

Contact diameter of pin Ø 1 mm

Cross-section mm <sup>2</sup>	AWG	Plating	Version	Type	Cat. No.	Qty.
0.5	20	Au	Male	HDC-C-HE-SM0.5Au	<b>1651420000</b>	100
	20	Ag	Male	HDC-C-HE-SM0.5Ag	<b>1200500000</b>	100
0.5	20	Au	Female	HDC-C-HE-BM0.5Au	<b>1651470000</b>	100
	20	Ag	Female	HDC-C-HE-BM0.5Ag	<b>1201100000</b>	100
0.75 - 1.00	18	Au	Male	HDC-C-HE-SM0.75-1.00Au	<b>1651430000</b>	100
	18	Ag	Male	HDC-C-HE-SM0.75-1.00Ag	<b>1200600000</b>	100
0.75 - 1.00	18	Au	Female	HDC-C-HE-BM0.75-1.00Au	<b>1651480000</b>	100
	18	Ag	Female	HDC-C-HE-BM0.75-1.00Ag	<b>1201200000</b>	100
1.5	16	Au	Male	HDC-C-HE-SM1.5Au	<b>1651440000</b>	100
	16	Ag	Male	HDC-C-HE-SM1.5Ag	<b>1200700000</b>	100
1.5	16	Au	Female	HDC-C-HE-BM1.5Au	<b>1651490000</b>	100
	16	Ag	Female	HDC-C-HE-BM1.5Ag	<b>1201300000</b>	100
2.5	14	Au	Male	HDC-C-HE-SM2.5Au	<b>1651450000</b>	100
	14	Ag	Male	HDC-C-HE-SM2.5Ag	<b>1200800000</b>	100
2.5	14	Au	Female	HDC-C-HE-BM2.5Au	<b>1651500000</b>	100
	14	Ag	Female	HDC-C-HE-BM2.5Ag	<b>1201400000</b>	100
4.0	12	Au	Male	HDC-C-HE-SM4.0Au	<b>1651460000</b>	100
	12	Ag	Male	HDC-C-HE-SM4.0Ag	<b>1200900000</b>	100
4.0	12	Au	Female	HDC-C-HE-BM4.0Au	<b>1651510000</b>	100
	12	Ag	Female	HDC-C-HE-BM4.0Ag	<b>1201500000</b>	100



# Frames Group Size 3

## Frames CR 6 / 2 modules

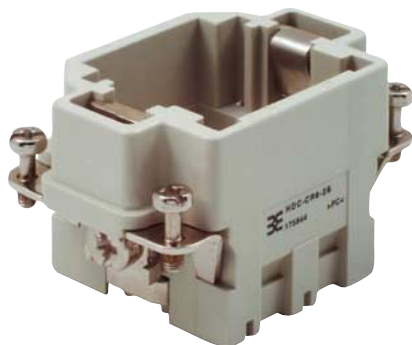

Male frame

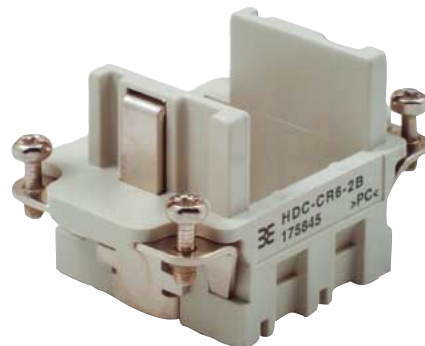

Female frame

### Dimensions

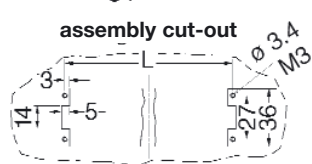
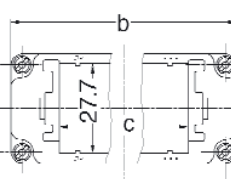
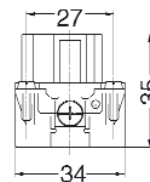
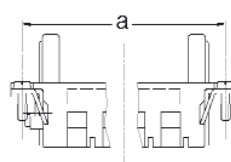
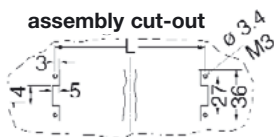
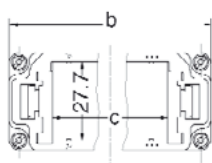
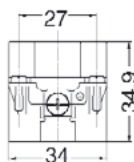

Colour		Black	Grey								
Version	Type	Cat. No.	Cat. No.	Qty.	a (mm)	b (mm)	c (mm)	L (mm)	Remarks	Group size	
Male	HDC-CR6-2S	1682180000	1758440000	5	44	51	23	44	for 2 modules	3	
Female	HDC-CR6-2B	1682190000	1758450000	5	44	51	23	44	for 2 modules	3	

For accessories see section "Accessories"

# Housings Group Size 3

## Plug hood HB-6

End locking lower side



TOVL

## Plug hood HBD-16

End locking lower side / high version



TOVL

## Base housing HB-6

End locking, with/without cover



SVL



SDVL

### Dimensions

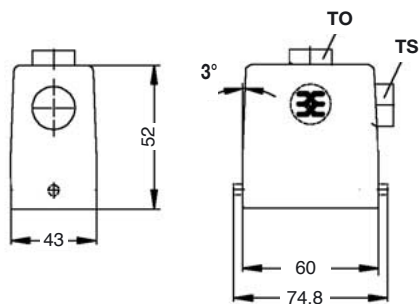

### Dimensions

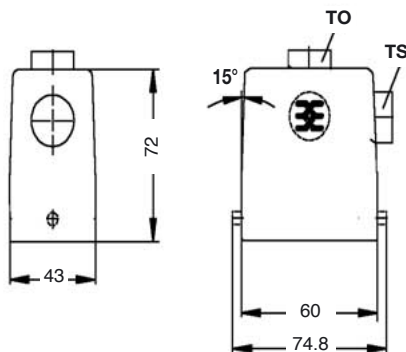

### Dimensions

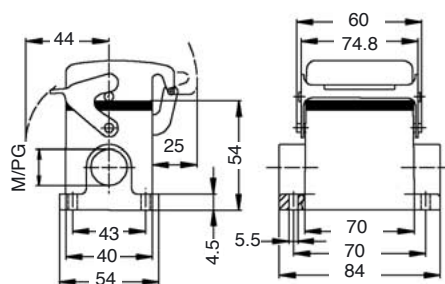

Version	Type	Cat. No.	Qty.
<b>Standard housings, metric thread</b>			
1 x M 20 thread	HDC HB6 TOVL 1xM20G	1788120000	5
1 x M 25 thread	HDC HB6 TOVL 1xM25G	1788110000	5
1 x M 20 thread	HDC HB6 TSVL 1xM20G	1805930000	5
1 x M 20 sleeve	HDC HB6 TSVL 1xM20	1788100000	5
1 x M 25 sleeve	HDC HB6 TSVL 1xM25	1788090000	5
<b>Standard housings, PG thread</b>			
1 x Pg13 complete	HDC-HB-6-TOVL1/13P	1201800000	5
1 x Pg13 sleeve	HDC-HB-6-TOVL1/13	1670500000	5
1 x Pg16 complete	HDC-HB-6-TOVL1/16P	1652630000	5
1 x Pg16 sleeve	HDC-HB-6-TOVL1/16	1652640000	5
1 x Pg13 complete	HDC-HB-6-TSVL1/13P	1201900000	5
1 x Pg13 sleeve	HDC-HB-6-TSVL1/13	1670530000	5
1 x Pg16 complete	HDC-HB-6-TSVL1/16P	1652510000	5
1 x Pg16 sleeve	HDC-HB-6-TSVL1/16	1652520000	5

Version	Type	Cat. No.	Qty.
<b>Standard housings, metric thread</b>			
1 x M 25 thread	HDC HBD16 TOVL 1xM25G	1787500000	5
1 x M 32 thread	HDC HBD16 TOVL 1xM32G	1787490000	5
1 x M 25 thread	HDC HBD16 TSVL 1xM25G	1787480000	5
1 x M 32 thread	HDC HBD16 TSVL 1xM32G	1787470000	5
<b>Standard housings, PG thread</b>			
1 x Pg21 complete	HDC-HBD-16-TOVL1/21P	1652670000	5
1 x Pg21 sleeve	HDC-HBD-16-TOVL1/21	1652680000	5
1 x Pg29 complete	HDC-HBD-16-TOVL1/29P	1652690000	5
1 x Pg29 sleeve	HDC-HBD-16-TOVL1/29	1652700000	5
1 x Pg21 complete	HDC-HBD-16-TSVL1/21P	1652550000	5
1 x Pg21 sleeve	HDC-HBD-16-TSVL1/21	1652560000	5
1 x Pg29 complete	HDC-HBD-16-TSVL1/29P	1652570000	5
1 x Pg29 sleeve	HDC-HBD-16-TSVL1/29	1652580000	5

Version	Type	Cat. No.	Qty.
<b>Standard housings, metric thread</b>			
2 x M 20 thread	HDC HB6 SVL 2xM20G	1788140000	5
2 x M 25 thread	HDC HB6 SVL 2xM25G	1788130000	5
<b>Standard housings with cover, metric thread</b>			
2 x M 20 thread	HDC HB6 SDVL 2xM20G	1788170000	2
2 x M 25 thread	HDC HB6 SDVL 2xM25G	1788160000	2
<b>Standard housings, PG thread</b>			
1 x Pg16 complete	HDC-HB-6-SVL1/16P	1202200000	5
1 x Pg16 sleeve	HDC-HB-6-SVL1/16	1652750000	5
2 x Pg16 complete	HDC-HB-6-SVL2/16P	1202300000	5
2 x Pg16 sleeve	HDC-HB-6-SVL2/16	1652760000	5
<b>Standard housings with cover, PG thread</b>			
1 x Pg16 complete	HDC-HB-6-SDVL1/16P	1202600000	2
1 x Pg16 sleeve	HDC-HB-6-SDVL1/16	1652980000	2
2 x Pg16 complete	HDC-HB-6-SDVL2/16P	1202700000	2
2 x Pg16 sleeve	HDC-HB-6-SDVL2/16	1652990000	2

TOVL = Plug hood; Top cable entry, end locking  
 TSVL = Plug hood; Side cable entry, end locking

TOVL = Plug hood; Top cable entry, end locking  
 TSVL = Plug hood; Side cable entry, end locking

SVL = Base housing, end locking  
 SDVL = Base housing with cover, end locking

For accessories see section "Accessories"

# Housings Group Size 3

## Base housing HBD-16

End locking, with/without cover, high version



SVL



SDVL

### Dimensions

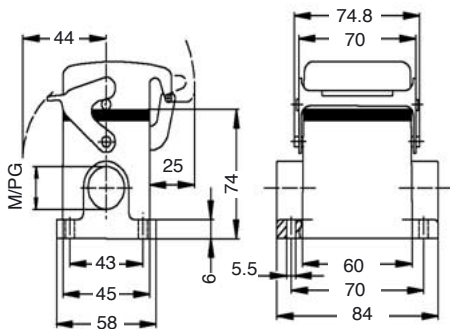

Version	Type	Cat. No.	Qty.
<b>Standard housings, metric thread</b>			
1 x M 20 sleeve	HDC HB10 TSVU 1xM20	1787560000	5
1 x M 25 sleeve	HDC HB10 TSVU 1xM25	1787550000	5
1 x M 20 thread	HDC HB10 TOVU 1xM20G	1787600000	5
1 x M 25 thread	HDC HB10 TOVU 1xM25G	1787590000	5
<b>Standard housings, PG thread</b>			
1 x Pg16 complete	HDC-HB-10-TSVU1/16P	1204800000	5
1 x Pg16 sleeve	HDC-HB-10-TSVU1/16	1654070000	5
1 x Pg21 complete	HDC-HB-10-TSVU1/21P	1654080000	5
1 x Pg21 sleeve	HDC-HB-10-TSVU1/21	1654090000	5
1 x Pg16 complete	HDC-HB-10-TOVU1/16P	1204700000	5
1 x Pg16 sleeve	HDC-HB-10-TOVU1/16	1654220000	5
1 x Pg21 complete	HDC-HB-10-TOVU1/21P	1654230000	5
1 x Pg21 sleeve	HDC-HB-10-TOVU1/21	1654240000	5

TSVU = Plug hood; Side cable entry, side locking lower side

TOVU = Plug hood; Top cable entry, side locking lower side

For accessories see section "Accessories"

## Coupling hood HB-6 / HBD-16

End locking



KVL



KVL

### Dimensions

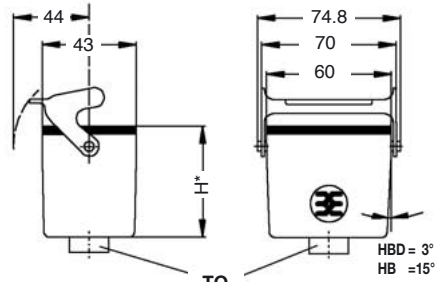

\*HB = 54.8  
HBD = 74.8

Version	Type	Cat. No.	Qty.
<b>Standard housings, PG thread</b>			
1 x Pg16 complete	HDC-HB-6-KVL1/16P	1202400000	5
1 x Pg16 sleeve	HDC-HB-6-KVL1/16	1653200000	5
1 x Pg21 complete	HDC-HBD-16-KVL1/21P	1653230000	5

KVL = Coupling hood, end locking

## Cover for plug hood

Cover with cord

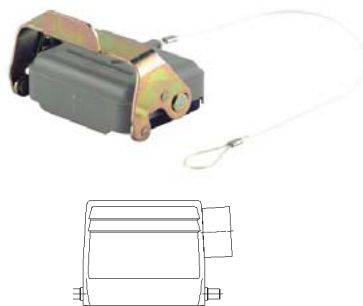

Type	Cat. No.	Qty.
<b>Plastic cover</b>		
HDC-HB-6-DT	1665210000	2

## Bulkhead housing HB-6

End locking, with/without cover



AVL



ADVL

### Dimensions

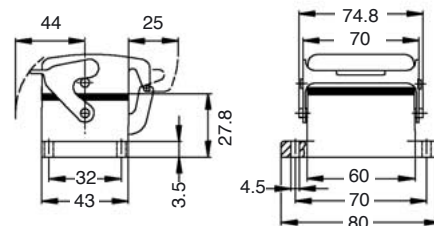

Version	Type	Cat. No.	Qty.
<b>Standard housings</b>			
	HDC-HB-6-AVL	1202100000	5
<b>Standard housings with cover</b>			
	HDC-HB-6-ADVL	1202500000	5

AVL = Bulkhead housing, end locking

ADVL = Bulkhead housing with cover, end locking

## Cover for lower side with end locking

Cover with cord

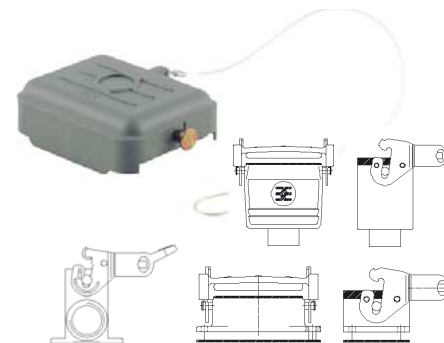

Type	Cat. No.	Qty.
<b>Plastic cover</b>		
HDC-HB-6-DB	1665200000	5

# Frames Group Size 4

## Frames CR 10 / 3 modules

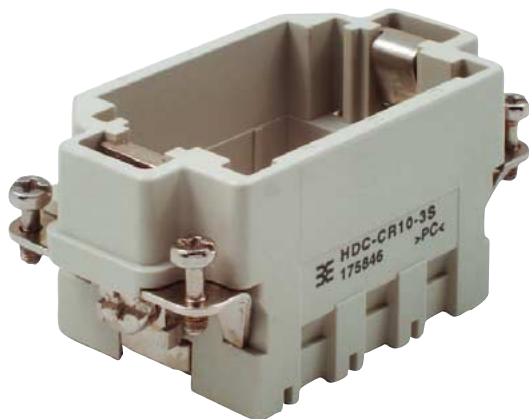

Male frame

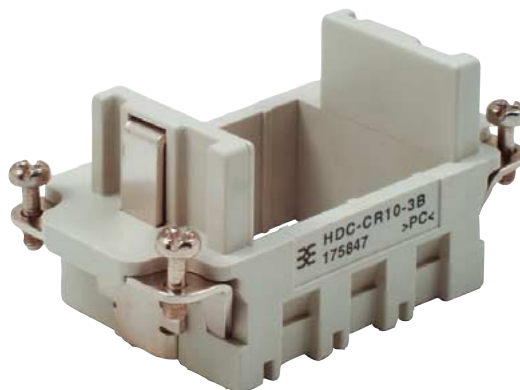

Female frame

### Dimensions

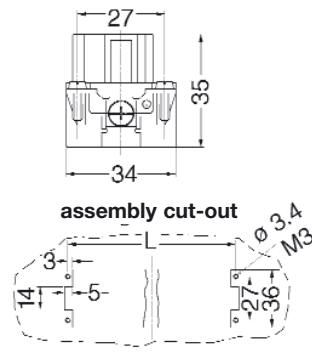
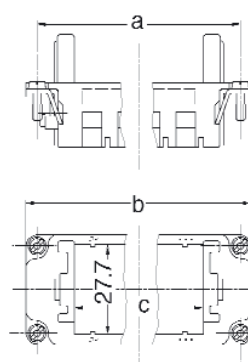
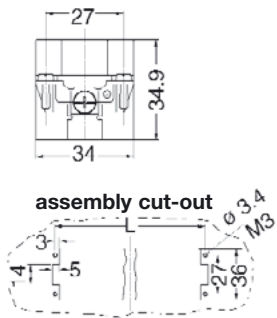
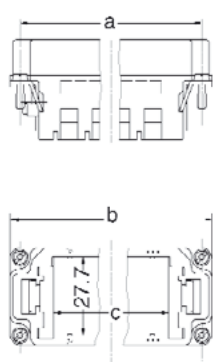

Colour		Black	Grey		a (mm)	b (mm)	c (mm)	L (mm)	Remarks	Group size
Version	Type	Cat. No.	Cat. No.	Qty.						
Male	HDC-CR10-3S	1682200000	1758460000	5	57	64	34.5	57	for 3 modules	4
Female	HDC-CR10-3B	1682210000	1758470000	5	57	64	34.5	57	for 3 modules	4

For accessories see section "Accessories"

# Housings Group Size 4

## Plug hood HB-10

Side locking lower side



TOVU



TSVU

Dimensions

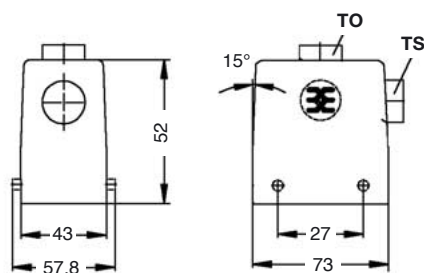

Version	Type	Cat. No.	Qty.
<b>Standard housings, metric thread</b>			
1 x M 20 thread	HDC HB10 TSVU 1xM20G	1787560000	5
1 x M 25 thread	HDC HB10 TSVU 1xM25G	1787550000	5
1 x M 20 thread	HDC HB10 TOVU 1xM20G	1787600000	5
1 x M 25 thread	HDC HB10 TOVU 1xM25G	1787590000	5
<b>Standard housings, PG thread</b>			
1 x Pg16 complete	HDC-HB-10-TSVU1/16P	1204800000	5
1 x Pg16 sleeve	HDC-HB-10-TSVU1/16	1654070000	5
1 x Pg21 complete	HDC-HB-10-TSVU1/21P	1654080000	5
1 x Pg21 sleeve	HDC-HB-10-TSVU1/21	1654090000	5
1 x Pg16 complete	HDC-HB-10-TOVU1/16P	1204700000	5
1 x Pg16 sleeve	HDC-HB-10-TOVU1/16	1654220000	5
1 x Pg21 complete	HDC-HB-10-TOVU1/21P	1654230000	5
1 x Pg21 sleeve	HDC-HB-10-TOVU1/21	1654240000	5

**TSVU** = Plug hood; Side cable entry, side locking lower side  
**TOVU** = Plug hood; Top cable entry, side locking lower side

## Plug hood HBD-24

Side locking lower side / high version



TOVU



TSVU

Dimensions

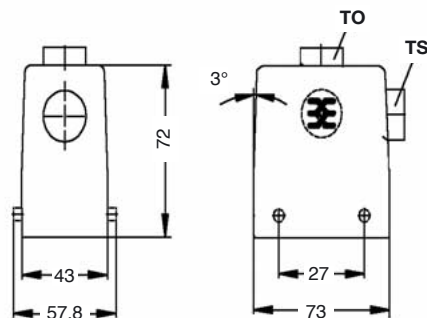

Version	Type	Cat. No.	Qty.
<b>Standard housings, metric thread</b>			
1 x M 25 thread	HDC HBD24 TSVU 1xM25G	1787240000	5
1 x M 32 thread	HDC HBD24 TSVU 1xM32G	1787230000	5
1 x M 25 thread	HDC HBD24 TOVU 1xM25G	1787300000	5
1 x M 32 thread	HDC HBD24 TOVU 1xM32G	1787290000	5
<b>Standard housings, PG thread</b>			
1 x Pg21 complete	HDC-HBD-24-TSVU1/21P	1654140000	5
1 x Pg21 sleeve	HDC-HBD-24-TSVU1/21	1654150000	5
1 x Pg29 complete	HDC-HBD-24-TSVU1/29P	1654160000	5
1 x Pg29 sleeve	HDC-HBD-24-TSVU1/29	1654170000	5
1 x Pg21 complete	HDC-HBD-24-TOVU1/21P	1654290000	5
1 x Pg29 complete	HDC-HBD-24-TOVU1/29P	1654310000	5

**TSVU** = Plug hood; Side cable entry, side locking lower side  
**TOVU** = Plug hood; Top cable entry, side locking lower side

## Base housing HB-10 / HBD-24

Side locking



SVU



SVU

Dimensions

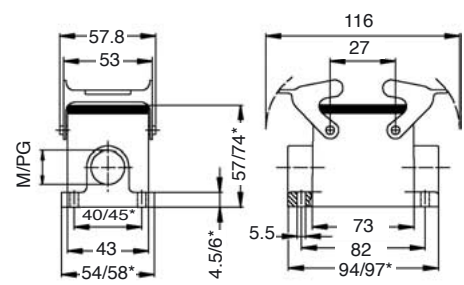

\*HB/HBD

Version	Type	Cat. No.	Qty.
<b>Standard housings, metric thread</b>			
1 x M 20 thread	HDC HB10 SVU 2xM20G	1787640000	2
1 x M 25 thread	HDC HB10 SVU 2xM25G	1787630000	2
2 x M 25 thread	HDC HBD24 SVU 2xM25G	1787350000	2
2 x M 32 thread	HDC HBD24 SVU 2xM32G	1787360000	2
<b>Standard housings, PG thread</b>			
1 x Pg16 complete	HDC-HB-10-SVU1/16P	1205100000	2
1 x Pg16 sleeve	HDC-HB-10-SVU1/16	1654370000	2
2 x Pg16 complete	HDC-HB-10-SVU2/16P	1205200000	2
2 x Pg16 sleeve	HDC-HB-10-SVU2/16	1654380000	2
1 x Pg21 complete	HDC-HBD-24-SVU1/21P	1654420000	2
1 x Pg21 sleeve	HDC-HBD-24-SVU1/21	1654430000	2
1 x Pg29 sleeve	HDC-HBD-24-SVU1/29	1654470000	2
2 x Pg21 complete	HDC-HBD-24-SVU2/21P	1654440000	2
2 x Pg21 sleeve	HDC-HBD-24-SVU2/21	1654450000	2
2 x Pg29 complete	HDC-HBD-24-SVU2/29P	1654480000	2

**SVU** = Base housing, side locking

For accessories see section "Accessories"

## Housings Group Size 4

### Coupling hood HB-10 / HBD 24

Side locking



**KVV**



**KVV**

Dimensions

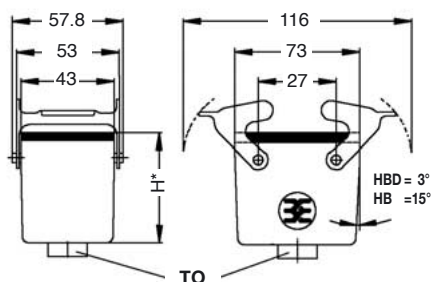

\*HB = 54.8  
HBD = 74.8

Version	Type	Cat. No.	Qty.
<b>Standard housings, metric thread</b>			
1 x M 20 thread	HDC HB10 KVV 1xM20G	1787720000	5
1 x M 25 thread	HDC HB10 KVV 1xM25G	1787710000	5
1 x M 25 thread	HDC HBD24 KVV 1xM25G	1787440000	2
1 x M 32 thread	HDC HBD24 KVV 1xM32G	1787430000	2
<b>Standard housings, PG thread</b>			
1 x Pg16 complete	HDC-HB-10-KVV1/16P	1205300000	5
1 x Pg16 sleeve	HDC-HB-10-KVV1/16	1654580000	5
1 x Pg21 complete	HDC-HB-10-KVV1/21P	1654590000	5
1 x Pg21 complete	HDC-HBD-24-KVV1/21P	1654650000	2
1 x Pg29 complete	HDC-HBD-24-KVV1/29P	1654670000	2

**KVV** = Coupling hood, side locking

### Cover for plug hood

Cover with cord



Type	Cat. No.	Qty.
<b>Plastic cover</b>		
HDC-HB-10-DT	1665240000	2

### Bulkhead housing HB-10

Side locking



**AVU**

Dimensions

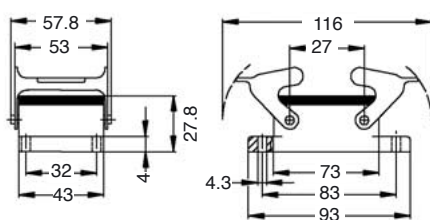

Version	Type	Cat. No.	Qty.
<b>Standard housings</b>			
	HDC-HB-10-AVU	1205000000	5

**AVU** = Bulkhead housing, side locking

### Cover for lower side with side locking

Cover with cord

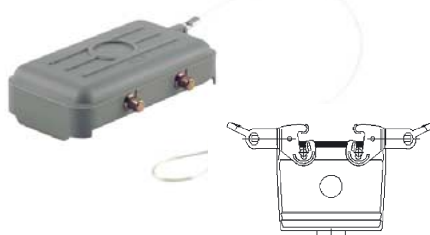

Type	Cat. No.	Qty.
<b>Plastic cover</b>		
HDC-HB-10-DB	1665230000	5

### Plug hood HB-10 / HBD-24

Side locking



**TSVO**

Dimensions

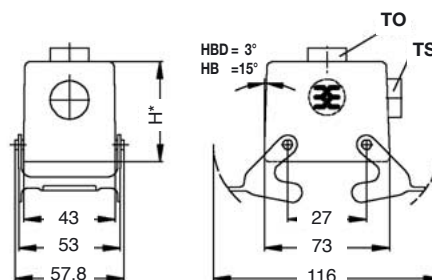

\*HB = 52  
HBD = 72

Version	Type	Cat. No.	Qty.
<b>Standard housings, metric thread</b>			
1 x M 25 sleeve	HDC HB10 TSVO 1xM25	1787570000	5
1 x M 25 thread	HDC HB10 TOVO 1xM25G	1787610000	5
1 x M 25 thread	HDC HBD24 TSVO 1xM25G	1787260000	2
1 x M 32 thread	HDC HBD24 TSVO 1xM32G	1787250000	2
1 x M 25 thread	HDC HBD24 TOVO 1xM25G	1787320000	2
1 x M 32 thread	HDC HBD24 TOVO 1xM32G	1787310000	2
<b>Standard housings, PG thread</b>			
1 x Pg16 complete	HDC-HB-10-TSVO1/16P	1205500000	5
1 x Pg16 sleeve	HDC-HB-10-TSVO1/16	1654750000	5
1 x Pg16 complete	HDC-HB-10-TOVO1/16P	1205400000	5
1 x Pg16 sleeve	HDC-HB-10-TOVO1/16	1654860000	5
1 x Pg21 sleeve	HDC-HBD-24-TSVO1/21	1654790000	2
1 x Pg29 complete	HDC-HBD-24-TSVO1/29P	1654800000	2
1 x Pg29 sleeve	HDC-HBD-24-TSVO1/29	1654810000	2
1 x Pg21 complete	HDC-HBD-24-TOVO1/21P	1654890000	2
1 x Pg29 complete	HDC-HBD-24-TOVO1/29P	1654910000	2
1 x Pg29 sleeve	HDC-HBD-24-TOVO1/29	1654920000	2

**TSVO** = Plug hood; Side cable entry, side locking  
**TOVO** = Plug hood; Top cable entry, side locking

For accessories see section "Accessories"

# Housings Group Size 4

## Base housing HB-10 / HBD-24

Side locking upper side



SDVO

Dimensions

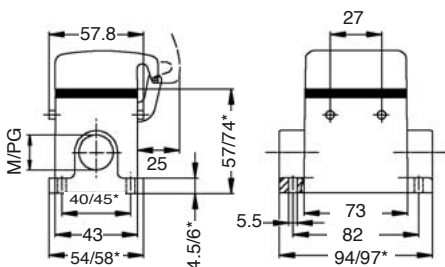

\*HB/HBD

Version	Type	Cat. No.	Qty.
<b>Standard housings with cover, metric thread</b>			
1 x M 20 thread	HDC HB10 SDVO 2xM20G	1787680000	2
1 x M 25 thread	HDC HB10 SDVO 2xM25G	1787670000	2
1 x M 25 thread	HDC HBD24 SDVO 2xM25G	1787400000	1
1 x M 32 thread	HDC HBD24 SDVO 2xM32G	1787390000	1
<b>Standard housings with cover, PG thread</b>			
1 x Pg16 complete	HDC-HB-10-SDVO1/16P	1205700000	2
1 x Pg16 sleeve	HDC-HB-10-SDVO1/16	1654990000	2
2 x Pg16 complete	HDC-HB-10-SDVO2/16P	1205800000	2
2 x Pg16 sleeve	HDC-HB-10-SDVO2/16	1655000000	2
1 x Pg21 complete	HDC-HBD-24-SDVO1/21P	1655050000	1
1 x Pg29 complete	HDC-HBD-24-SDVO1/29P	1655090000	1
2 x Pg29 complete	HDC-HBD-24-SDVO2/29P	1655110000	1

SDVO = Base housing with cover, side locking upper side

## Bulkhead housing HB-10

With cover / side locking upper side



ADVO

Dimensions

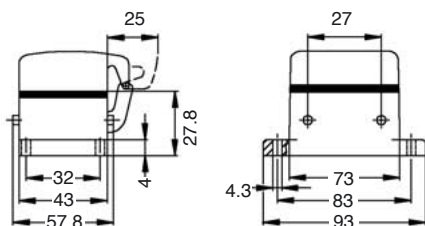

Version	Type	Cat. No.	Qty.
<b>Standard housings with cover</b>			
	HDC-HB-10-ADVO	1205600000	5
<b>ADVO = Bulkhead housing with cover, Side locking upper side</b>			

## Cover for plug hood with side locking

Cover with cord

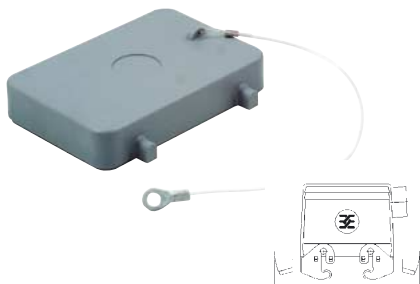

Type	Cat. No.	Qty.
<b>Plastic cover</b>		
HDC-HB-10-DBP	1665250000	5

TSVL = Plug hood; Side cable entry, end locking

TOVL = Plug hood; Top cable entry, end locking

## Plug hood HB-10 / HBD-24

End locking lower side



TOVL

TOVL

Dimensions

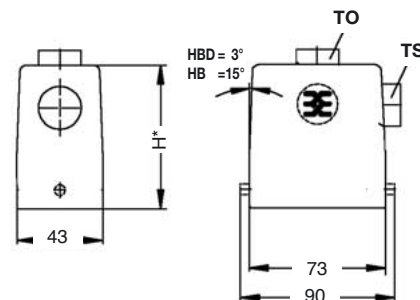

\*HB = 52  
HBD = 72

Version	Type	Cat. No.	Qty.
<b>Standard housings, metric thread</b>			
1 x M 25 sleeve	HDC HB10 TSVL 1xM25	1787580000	5
1 x M 25 thread	HDC HB10 TOVL 1xM25G	1787620000	5
1 x M 25 thread	HDC HBD24 TSVL 1xM25G	1787280000	2
1 x M 32 thread	HDC HBD24 TSVL 1xM32G	1787270000	2
1 x M 25 thread	HDC HBD24 TOVL 1xM25G	1787340000	2
1 x M 32 thread	HDC HBD24 TOVL 1xM32G	1787330000	2
<b>Standard housings, PG thread</b>			
1 x Pg16 complete	HDC-HB-10-TSVL1/16P	1206000000	5
1 x Pg16 sleeve	HDC-HB-10-TSVL1/16	1655210000	5
1 x Pg16 complete	HDC-HB-10-TOVL1/16P	1205900000	5
1 x Pg16 sleeve	HDC-HB-10-TOVL1/16	1655320000	5
1 x Pg21 complete	HDC-HBD-24-TSVL1/21P	1655240000	2
1 x Pg21 sleeve	HDC-HBD-24-TSVL1/21	1655250000	2
1 x Pg29 complete	HDC-HBD-24-TSVL1/29P	1655260000	2
1 x Pg29 sleeve	HDC-HBD-24-TSVL1/29	1655270000	2
1 x Pg21 complete	HDC-HBD-24-TOVL1/21P	1655350000	2
1 x Pg21 sleeve	HDC-HBD-24-TOVL1/21	1655360000	2
1 x Pg29 complete	HDC-HBD-24-TOVL1/29P	1655370000	2
1 x Pg29 sleeve	HDC-HBD-24-TOVL1/29	1655380000	2

TSVL = Plug hood; Side cable entry, end locking

TOVL = Plug hood; Top cable entry, end locking

For accessories see section "Accessories"

# Housings Group Size 4

## Base housing HB-10 / HBD-24

End locking, with/without cover



SVL



SDVL

## Coupling hood HB-10 / HBD-24

End locking



KVL



KVL

## Bulkhead housing HB-10

End locking, with/without cover



AVL



ADVL

### Dimensions

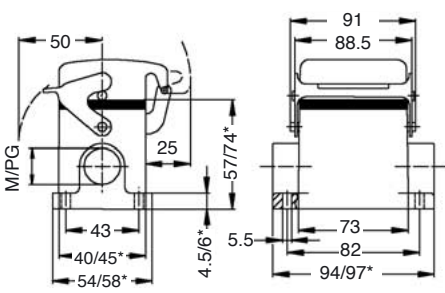

### Dimensions

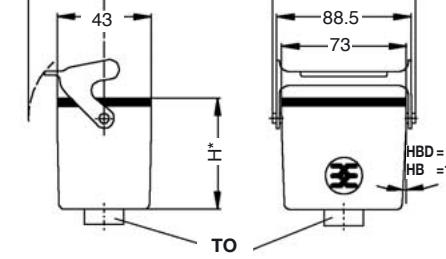

### Dimensions

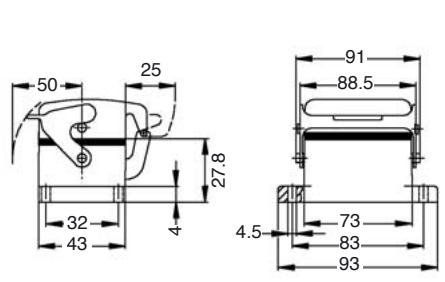

\*HB/HBG

\*HB = 54.8  
HBD = 74.8

Version	Type	Cat. No.	Qty.
<b>Standard housings, metric thread</b>			
2 x M 20 thread	HDC HB10 SVL 2xM20G	1787660000	2
2 x M 25 thread	HDC HB10 SVL 2xM25G	1787650000	2
2 x M 25 thread	HDC HBD24 SVL 2xM25G	1787380000	2
2 x M 32 thread	HDC HBD24 SVL 2xM32G	1787370000	2
<b>Standard housings with cover, metric thread</b>			
2 x M 20 thread	HDC HB10 SDVL 2xM20G	1787700000	2
2 x M 25 thread	HDC HB10 SDVL 2xM25G	1787690000	2
1 x M 25 thread	HDC HBD24 SDVL 1xM25G	1787420000	1
1 x M 32 thread	HDC HBD24 SDVL 1xM32G	1787410000	1
<b>Standard housings, PG thread</b>			
1 x Pg16 complete	HDC-HB-10-SVL1/16P	1206200000	2
1 x Pg16 sleeve	HDC-HB-10-SVL1/16	1655460000	2
2 x Pg16 complete	HDC-HB-10-SVL2/16P	1206300000	2
2 x Pg16 sleeve	HDC-HB-10-SVL2/16	1655470000	2
1 x Pg21 complete	HDC-HBD-24-SVL1/21P	1655510000	2
1 x Pg29 complete	HDC-HBD-24-SVL1/29P	1655550000	2
<b>Standard housings with cover, PG thread</b>			
1 x Pg16 complete	HDC-HB-10-SDVL1/16P	1206600000	2
1 x Pg16 sleeve	HDC-HB-10-SDVL1/16	1655670000	2
2 x Pg16 complete	HDC-HB-10-SDVL2/16P	1206700000	1
2 x Pg16 sleeve	HDC-HB-10-SDVL2/16	1655680000	1
1 x Pg21 complete	HDC-HBD-24-SDVL1/21P	1655720000	1

Version	Type	Cat. No.	Qty.
<b>Standard housings, metric thread</b>			
1 x M 20 thread	HDC HB10 KVL 1xM20G	1787740000	5
1 x M 25 thread	HDC HB10 KVL 1xM25G	1787730000	2
1 x M 25 thread	HDC HBD24 KVL 1xM25G	1787460000	2
1 x M 32 thread	HDC HBD24 KVL 1xM32G	1787450000	2
<b>Standard housings, PG thread</b>			
1 x Pg16 complete	HDC-HB-10-KVL1/16P	1655880000	5
1 x Pg16 sleeve	HDC-HB-10-KVL1/16	1655890000	5
1 x Pg21 complete	HDC-HB-10-KVL1/21P	1655900000	2

Version	Type	Cat. No.	Qty.
<b>Standard housings</b>			
	HDC-HB-10-AVL	1206100000	5
<b>Standard housings with cover</b>			
	HDC-HB-10-ADVL	1206500000	2

SVL = Base housing, end locking

SDVL = Base housing with cover, end locking

KVL = Coupling hood, end locking

AVL = Bulkhead housing, end locking

ADVL = Bulkhead housing with cover, end locking

For accessories see section "Accessories"

# Frames Group Size 6

## Frames CR 16 / 5 Modules

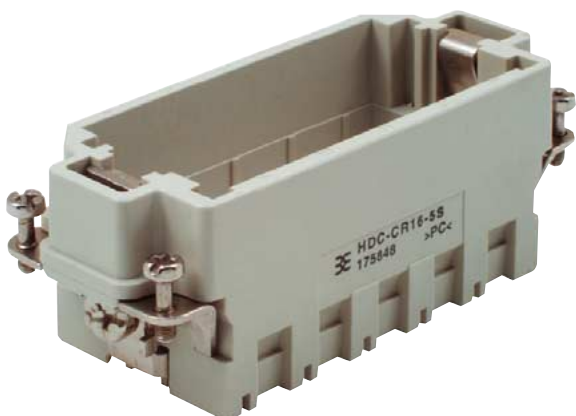

Male frame

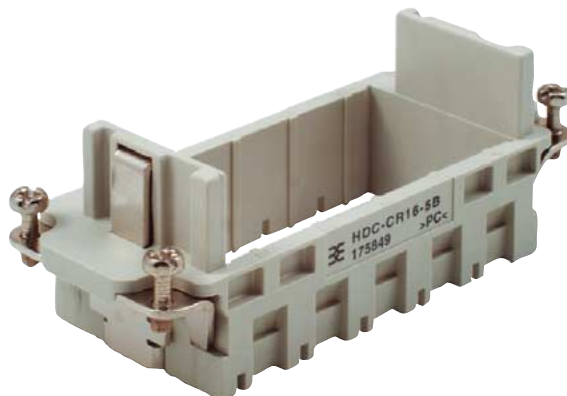

Female frame

### Dimensions

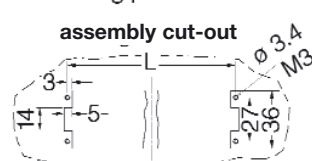
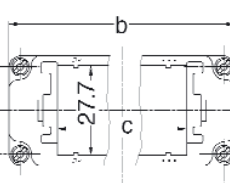
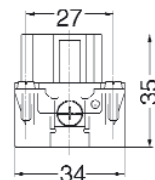
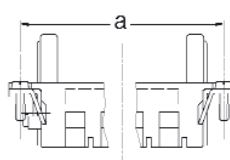
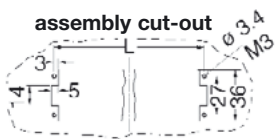
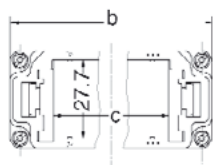
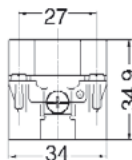
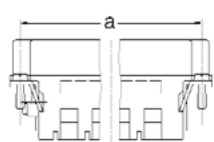

Colour		Black	Grey		a (mm)	b (mm)	c (mm)	L (mm)	Remarks	Group size
Male	HDC-CR16-5S	1682220000	1758480000	5	77.5	84.5	57.5	77.5	For 5 modules	<b>6 (10)</b>
Female	HDC-CR16-5B	1682230000	1758490000	5	77.5	84.5	57.5	77.5	For 5 modules	<b>6 (10)</b>
Male <sup>1)</sup>	HDC-CR16-5S-2		1758520000	5	77.5	84.5	57.5	77.5	For 5 modules	<b>10</b>
Female <sup>1)</sup>	HDC-CR16-5B-2		1758530000	5	77.5	84.5	57.5	77.5	For 5 modules	<b>10</b>

<sup>1)</sup> addition markings for the use of two frames in one housing.  
2 frames = groupe size 10.

For accessories see section "Accessories"

## Housings Group Size 6

### Plug hood HB-16 / HBD-40

Side locking lower side



TSVU



TOVU

Dimensions

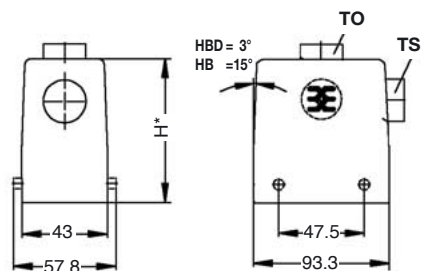

\*HB = 61  
HBD = 76

Version	Type	Cat. No.	Qty.
<b>Standard housings, metric thread</b>			
1 x M 25 sleeve	HDC HB16 TSVU 1xM25	1788180000	5
1 x M 25 thread	HDC HB16 TOVU 1xM25G	1788210000	5
1 x M 25 thread	HDC HBD40 TSVU 1xM25G	1787010000	5
1 x M 32 thread	HDC HBD40 TSVU 1xM32G	1787000000	5
1 x M 25 thread	HDC HBD40 TOVU 1xM25G	1787070000	5
1 x M 32 thread	HDC HBD40 TOVU 1xM32G	1787060000	5
<b>Standard housings, PG thread</b>			
1 x Pg21 complete	HDC-HB-16-TSVU1/21P	1208400000	5
1 x Pg21 sleeve	HDC-HB-16-TSVU1/21	1656480000	5
1 x Pg21 complete	HDC-HB-16-TOVU1/21P	1208300000	5
1 x Pg21 sleeve	HDC-HB-16-TOVU1/21	1656590000	5
1 x Pg21 complete	HDC-HBD-40-TSVU1/21P	1656510000	5
1 x Pg21 sleeve	HDC-HBD-40-TSVU1/21	1656520000	5
1 x Pg29 complete	HDC-HBD-40-TSVU1/29P	1656530000	5
1 x Pg29 sleeve	HDC-HBD-40-TSVU1/29	1656540000	5
1 x Pg21 complete	HDC-HBD-40-TOVU1/21P	1656620000	5
1 x Pg21 sleeve	HDC-HBD-40-TOVU1/21	1656630000	5
1 x Pg29 complete	HDC-HBD-40-TOVU1/29P	1656640000	5
1 x Pg29 sleeve	HDC-HBD-40-TOVU1/29	1656650000	5

TOVU = Plug hood; Top cable entry, side locking lower side

TSVU = Plug hood; Side cable entry, side locking lower side

For accessories see section "Accessories"

### Base housing HB-16 / HBD-40

Side locking



SVU

Dimensions

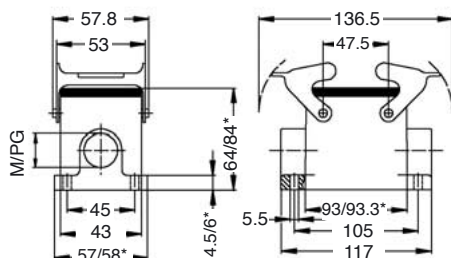

\*HB/HBD

Version	Type	Cat. No.	Qty.
<b>Standard housings, metric thread</b>			
1 x M 25 thread	HDC HB16 SVU 2xM25G	1788240000	2
2 x M 25 thread	HDC HBD40 SVU 2xM25G	1787120000	2
2 x M 32 thread	HDC HBD40 SVU 2xM32G	1787110000	2
<b>Standard housings, PG thread</b>			
1 x Pg21 complete	HDC-HB-16-SVU1/21P	1208700000	2
1 x Pg21 sleeve	HDC-HB-16-SVU1/21	1656720000	2
2 x Pg21 complete	HDC-HB-16-SVU2/21P	1208800000	2
2 x Pg21 sleeve	HDC-HB-16-SVU2/21	1656730000	2
1 x Pg21 sleeve	HDC-HBD-40-SVU1/21	1656790000	2
1 x Pg29 complete	HDC-HBD-40-SVU1/29P	1656820000	2
2 x Pg21 complete	HDC-HBD-40-SVU2/21P	1656800000	2
2 x Pg21 sleeve	HDC-HBD-40-SVU2/21	1656810000	2
2 x Pg29 complete	HDC-HBD-40-SVU2/29P	1656840000	2

SVU = Base housing, side locking lower side

### Coupling hood HB-16 / HBD-40

Side locking



KVVU

Dimensions

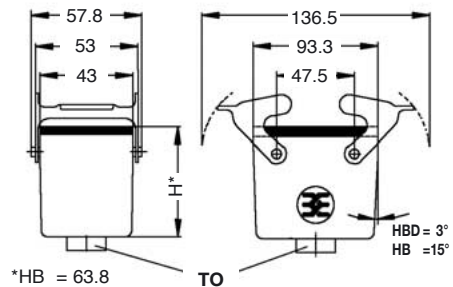

\*HB = 63.8  
HBD = 78.8

Version	Type	Cat. No.	Qty.
<b>Standard housings, metric thread</b>			
1 x M 25 thread	HDC HBD40 KVVU 1xM25G	1787200000	2
1 x M 32 thread	HDC HBD40 KVVU 1xM32G	1787190000	2
1 x M 25 thread	HDC HB16 KVVU 1xM25G	1788280000	2
<b>Standard housings, PG thread</b>			
1 x Pg21 complete	HDC-HB-16-KVVU1/21P	1208900000	2
1 x Pg21 sleeve	HDC-HB-16-KVVU1/21	1657270000	2
1 x Pg21 complete	HDC-HBD-40-KVVU1/21P	1657300000	2
1 x Pg21 sleeve	HDC-HBD-40-KVVU1/21	1657310000	2
1 x Pg29 complete	HDC-HBD-40-KVVU1/29P	1657320000	2

KVVU = Coupling hood, side locking

### Cover for plug hood

Cover with cord



Type	Cat. No.	Qty.
<b>Plastic cover</b>		
HDC-HB-16-DT	1665270000	2

# Housings Group Size 6

## Bulkhead housing HB-16

Side locking



AVU

Dimensions

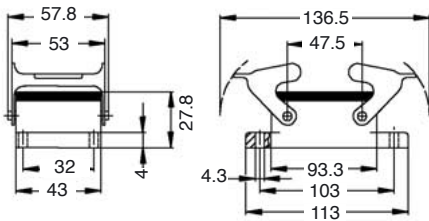

Version	Type	Cat. No.	Qty.
<b>Standard housings</b>			
	HDC-HB-16-AVU	1208600000	5

AVU = Bulkhead housing, side locking

## Cover for lower side with side locking

Cover with cord

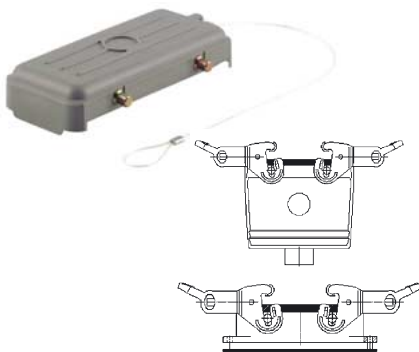

Type	Cat. No.	Qty.
<b>Plastic cover</b>		
HDC-HB-16-DB	1665260000	2

For accessories see section "Accessories"

## Plug hood HB-16 / HBD-40

Side locking



TSVO



TOVO

Dimensions

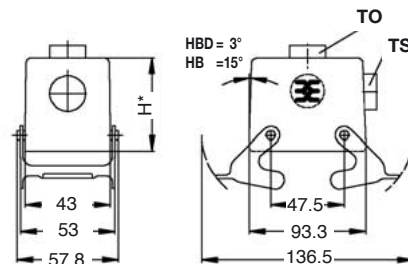

\*HB = 61  
HBD = 76

Version	Type	Cat. No.	Qty.
<b>Standard housings, metric thread</b>			

1 x M 25 sleeve	HDC HB16 TSVO 1xM25	1788190000	2
1 x M 25 thread	HDC HB16 TOVO 1xM25G	1788220000	2
1 x M 25 thread	HDC HBD40 TSVO 1xM25G	1787030000	2
1 x M 32 thread	HDC HBD40 TSVO 1xM32G	1787020000	2
1 x M 25 thread	HDC HBD40 TOVO 1xM25G	1787090000	2
1 x M 32 thread	HDC HBD40 TOVO 1xM32G	1787080000	2
<b>Standard housings, PG thread</b>			
1 x Pg21 complete	HDC-HB-16-TSVO1/21P	1209100000	2
1 x Pg21 sleeve	HDC-HB-16-TSVO1/21	1657380000	2
1 x Pg21 complete	HDC-HB-16-TOVO1/21P	1209000000	2
1 x Pg21 sleeve	HDC-HB-16-TOVO1/21	1657490000	2
1 x Pg21 complete	HDC-HBD-40-TSVO1/21P	1657410000	2
1 x Pg21 sleeve	HDC-HBD-40-TSVO1/21	1657420000	2
1 x Pg29 complete	HDC-HBD-40-TSVO1/29P	1657430000	2
1 x Pg21 complete	HDC-HBD-40-TOVO1/21P	1657520000	2
1 x Pg29 complete	HDC-HBD-40-TOVO1/29P	1657540000	2
1 x Pg29 sleeve	HDC-HBD-40-TOVO1/29	1657550000	2

TSVO = Plug hood; Side cable entry, side locking

TOVO = Plug hood; Top cable entry, side locking

## Base housing HB-16 / HBD-40

Side locking upper side



SDVO

Dimensions

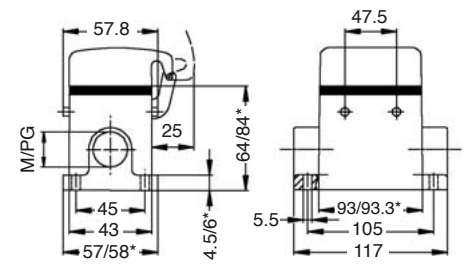

Version	Type	Cat. No.	Qty.
<b>Standard housings with cover, metric thread</b>			

2 x M 25 thread	HDC HB16 SDVO 2xM25G	1788260000	2
2 x M 25 thread	HDC HBD40 SDVO 2xM25G	1787160000	2
2 x M 32 thread	HDC HBD40 SDVO 2xM32G	1787150000	2
<b>Standard housings with cover, PG thread</b>			
1 x Pg21 complete	HDC-HB-16-SDVO1/21P	1209300000	2
2 x Pg21 complete	HDC-HB-16-SDVO2/21P	1209400000	2
2 x Pg21 sleeve	HDC-HB-16-SDVO2/21	1657640000	2
1 x Pg21 complete	HDC-HBD-40-SDVO1/21P	1657690000	2
1 x Pg21 sleeve	HDC-HBD-40-SDVO1/21	1657700000	2
2 x Pg21 complete	HDC-HBD-40-SDVO2/21P	1657710000	2

SDVO = Base housing with cover, side locking upper side

## Housings Group Size 6

### Bulkhead housing HB-16

Side locking upper side



ADVO

### Plug hood HB-16 / HBD-40

End locking lower side / high version



TOVL

### Base housing HB-16 / HBD-40

End locking with/without cover



SVL



TSVL



SDVL

#### Dimensions

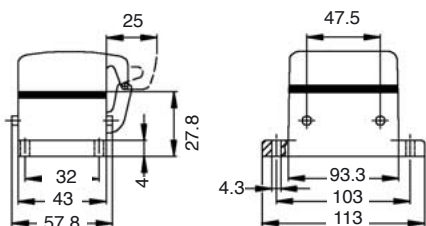

#### Dimensions

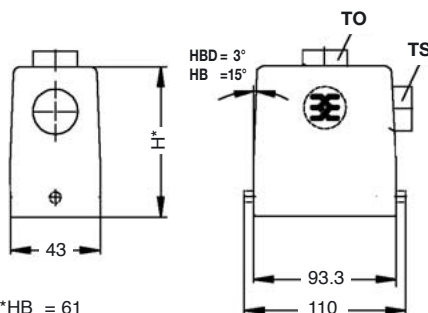

\*HB = 61  
HBD = 76

#### Dimensions

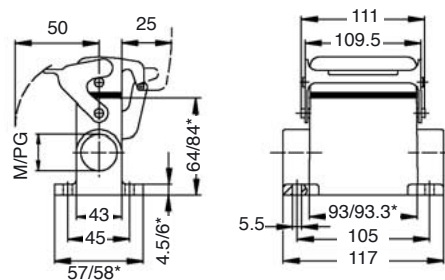

\*HB/HBD

Version	Type	Cat. No.	Qty.
<b>Standard housings</b>			
	HDC-HB-16-ADVO	1209200000	2

ADVL = Bulkhead housing with cover, side locking

Version	Type	Cat. No.	Qty.
<b>Standard housings, metric thread</b>			
1 x M 25 sleeve	HDC HB16 TSVL 1xM25	1788200000	5
1 x M 25 thread	HDC HB16 TOVL 1xM25G	1788230000	5
1 x M 32 thread	HDC HB16 TSVL 1xM32G	1804640000	5
1 x M 32 thread	HDC HB16 TOVL 1xM32G	1804630000	5
1 x M 25 thread	HDC HBD40 TSVL 1xM25G	1787050000	5
1 x M 32 thread	HDC HBD40 TSVL 1xM32G	1787040000	5
1 x M 32 thread	HDC HBD40 TOVL 1xM32G	1787100000	5

Version	Type	Cat. No.	Qty.
<b>Standard housings, PG thread</b>			
1 x Pg21 complete	HDC-HB-16-TSVL1/21P	1209600000	5
1 x Pg21 sleeve	HDC-HB-16-TSVL1/21	1657850000	5
1 x Pg21 complete	HDC-HB-16-TOVL1/21P	1209500000	5
1 x Pg21 sleeve	HDC-HB-16-TOVL1/21	1657960000	5
1 x Pg21 complete	HDC-HBD-40-TSVL1/21P	1657880000	5
1 x Pg21 sleeve	HDC-HBD-40-TSVL1/21	1657890000	5
1 x Pg29 complete	HDC-HBD-40-TSVL1/29P	1657900000	5
1 x Pg29 sleeve	HDC-HBD-40-TSVL1/29	1657910000	5
1 x Pg21 complete	HDC-HBD-40-TOVL1/21P	1657990000	5
1 x Pg21 sleeve	HDC-HBD-40-TOVL1/21	1658000000	5
1 x Pg29 complete	HDC-HBD-40-TOVL1/29P	1658010000	5
1 x Pg29 sleeve	HDC-HBD-40-TOVL1/29	1658020000	5

Version	Type	Cat. No.	Qty.
<b>Standard housings, metric thread</b>			
2 x M 25 thread	HDC HB16 SVL 2xM25G	1788250000	2
2 x M 25 thread	HDC HBD40 SVL 2xM25G	1787140000	2
2 x M 32 thread	HDC HBD40 SVL 1xM32G	1804660000	2
2 x M 32 thread	HDC HBD40 SVL 2xM32G	1787130000	2
2 x M 25 thread	HDC HB16 SDVL 2xM25G	1788270000	2
2 x M 25 thread	HDC HBD40 SDVL 2xM25G	1787180000	2
2 x M 32 thread	HDC HBD40 SDVL 2xM32G	1787170000	2

Version	Type	Cat. No.	Qty.
<b>Standard housings, PG- thread</b>			
1 x Pg21 complete	HDC-HB-16-SVL1/21P	1209800000	2
1 x Pg21 sleeve	HDC-HB-16-SVL1/21	1658110000	2
2 x Pg21 complete	HDC-HB-16-SVL2/21P	1209900000	2
2 x Pg21 sleeve	HDC-HB-16-SVL2/21	1658120000	2
1 x Pg21 complete	HDC-HB-16-SDVL1/21P	1210200000	2
1 x Pg21 sleeve	HDC-HB-16-SDVL1/21	1658320000	2
2 x Pg21 complete	HDC-HB-16-SDVL2/21P	1210300000	2
2 x Pg21 sleeve	HDC-HB-16-SDVL2/21	1658330000	2
1 x Pg21 complete	HDC-HBD-40-SDVL1/21P	1658370000	2
1 x Pg29 complete	HDC-HBD-40-SDVL1/29P	1658410000	2
2 x Pg29 complete	HDC-HBD-40-SDVL2/29P	1658430000	2

### Cover for plug hood with side locking

Cover with cord

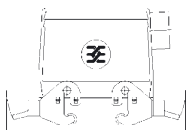

Type	Cat. No.	Qty.
<b>Plastic cover</b>		
HDC-HB-16-DBP	1665620000	5

TSVL = Plug hood; Side cable entry, end locking lower side

TOVL = Plug hood; Top cable entry, end locking lower side

SVL = Base housing, end locking

SDVL = Base housing with cover, end locking

For accessories see section "Accessories"

# Housings Group Size 6

## Coupling hood HB-16 / HBD-40

End locking



**KVL**

## Bulkhead housing HB-16

End locking



**AVL**



**ADVL**

Dimensions

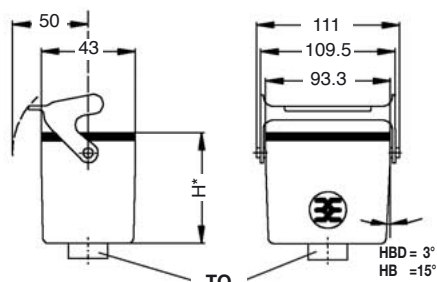

\*HB = 63.5  
HBD = 78.5

Dimensions

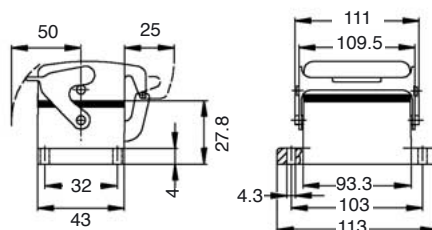

Version	Type	Cat. No.	Qty.
<b>Standard housings, metric thread</b>			
1 x M 25 thread	HDC HB16 KVL 1xM25G	<b>1788290000</b>	2
1 x M 25 thread	HDC HBD40 KVL 1xM25G	<b>1787220000</b>	2
1 x M 32 thread	HDC HBD40 KVL 1xM32G	<b>1787210000</b>	2
<b>Standard housings, PG thread</b>			
1 x Pg21 complete	HDC-HB-16-KVL1/21P	<b>1210000000</b>	2
1 x Pg29 complete	HDC-HBD-40-KVL1/29P	<b>1658580000</b>	2

Version	Type	Cat. No.	Qty.
<b>Standard housings</b>			
	HDC-HB-16-AVL	<b>1209700000</b>	5
<b>Standard housings with cover</b>			
	HDC-HB-16-ADVL	<b>1210100000</b>	2
<b>AVL = Bulkhead housing, end locking</b>			
<b>ADVL = Bulkhead housing with cover, end locking</b>			

KVL = Coupling hood, end locking

For accessories see section "Accessories"



# Frames Group Size 8

## Frames CR 24 / 7 modules

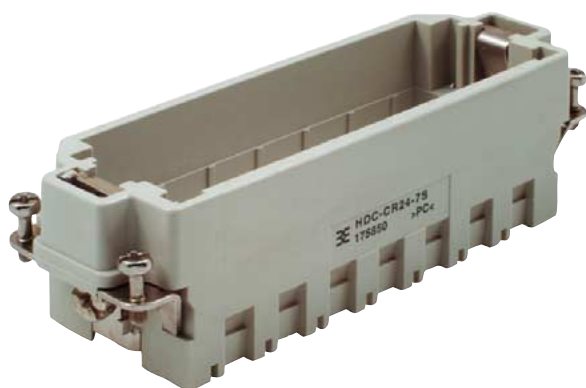

Male frame

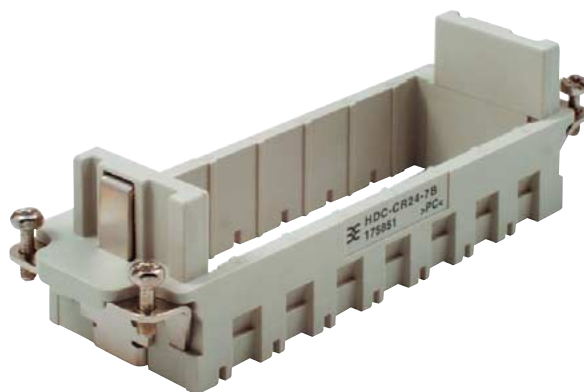

Female frame

### Dimensions

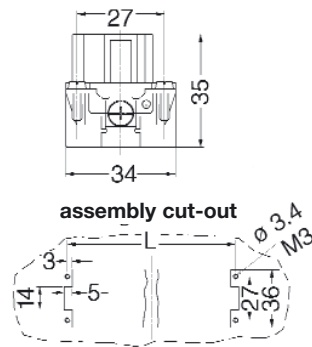
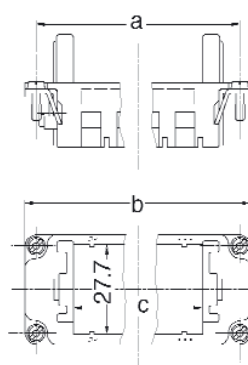
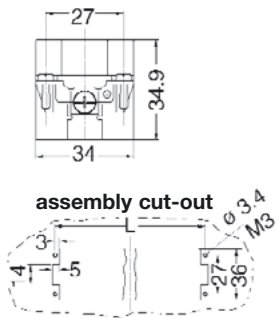
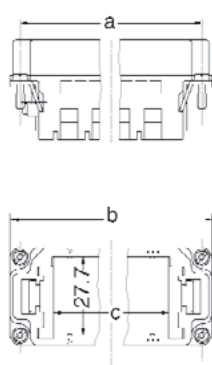

Colour		Black	Grey		a (mm)	b (mm)	c (mm)	L (mm)	Remarks	Group size
Male	HDC-CR24-7S	1682240000	1758500000	5	104	111	80.5	104	for 7 modules	<b>8 (12)</b>
Female	HDC-CR24-7B	1682250000	1758510000	5	104	111	80.5	104	for 7 modules	<b>8 (12)</b>
Male <sup>2)</sup>	HDC-CR24-7S-2		1758540000	5	104	111	80.5	104	for 7 modules	<b>12</b>
Female <sup>2)</sup>	HDC-CR24-7B-2		1758550000	5	104	111	80.5	104	for 7 modules	<b>12</b>

<sup>2)</sup> addition markings for the use of two frames in one housing.  
2 frames = group size 12.

For accessories see section "Accessories"

## Housings Group Size 8

### Plug hood HB-24

Side locking lower side



TOVU



TSVU

Dimensions

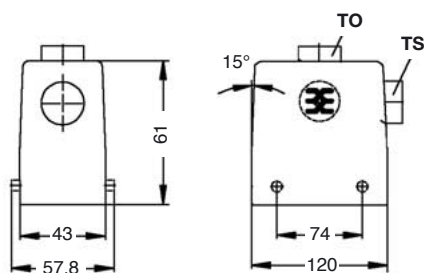

Version	Type	Cat. No.	Qty.
<b>Standard housings, metric thread</b>			
1 x M 25 thread	HDC HB24 TOVU 1xM25G	<b>1787820000</b>	2
1 x M 32 sleeve	HDC HB24 TSVU 1xM32	<b>1787750000</b>	2
1 x M 25 sleeve	HDC HB24 TSVU 1xM25	<b>1787760000</b>	2
1 x M 32 thread	HDC HB24 TOVU 1xM32G	<b>1787810000</b>	2
<b>Standard housings, PG thread</b>			
1 x Pg21 complete	HDC-HB-24-TSVU1/21P	<b>1212100000</b>	2
1 x Pg21 sleeve	HDC-HB-24-TSVU1/21	<b>1661230000</b>	2
1 x Pg29 complete	HDC-HB-24-TSVU1/29P	<b>1212200000</b>	2
1 x Pg29 sleeve	HDC-HB-24-TSVU1/29	<b>1661240000</b>	2
1 x Pg21 complete	HDC-HB-24-TOVU1/21P	<b>1211900000</b>	2
1 x Pg21 sleeve	HDC-HB-24-TOVU1/21	<b>1661370000</b>	2
1 x Pg29 complete	HDC-HB-24-TOVU1/29P	<b>1212000000</b>	2
1 x Pg29 sleeve	HDC-HB-24-TOVU1/29	<b>1661380000</b>	2

**TOVU** = Plug hood; Top cable entry, side locking lower side  
**TSVU** = Plug hood; Side cable entry, side locking lower side

### Plug hood HBD-64

Side locking lower side / high version



TOVU



TSVU

Dimensions

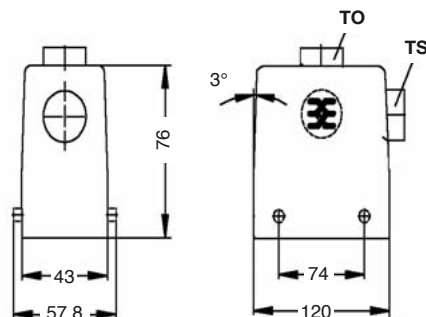

Version	Type	Cat. No.	Qty.
<b>Standard housings, metric thread</b>			
1 x M 25 thread	HDC HBD64 TSVU 1xM25G	<b>1786780000</b>	2
1 x M 32 thread	HDC HBD64 TSVU 1xM32G	<b>1786770000</b>	2
1 x M 25 thread	HDC HBD64 TOVU 1xM25G	<b>1786840000</b>	2
1 x M 32 thread	HDC HBD64 TOVU 1xM32G	<b>1786830000</b>	2
<b>Standard housings, PG thread</b>			
1 x Pg21 complete	HDC-HBD-64-TSVU1/21P	<b>1661290000</b>	2
1 x Pg21 sleeve	HDC-HBD-64-TSVU1/21	<b>1661300000</b>	2
1 x Pg29 complete	HDC-HBD-64-TSVU1/29P	<b>1661310000</b>	2
1 x Pg29 sleeve	HDC-HBD-64-TSVU1/29	<b>1661320000</b>	2
1 x Pg21 complete	HDC-HBD-64-TOVU1/21P	<b>1661430000</b>	2
1 x Pg21 sleeve	HDC-HBD-64-TOVU1/21	<b>1661440000</b>	2
1 x Pg29 complete	HDC-HBD-64-TOVU1/29P	<b>1661450000</b>	2
1 x Pg29 sleeve	HDC-HBD-64-TOVU1/29	<b>1661460000</b>	2

**TOVU** = Plug hood; Top cable entry, side locking lower side  
**TSVU** = Plug hood; Side cable entry, side locking lower side

### Base housing HB-24 / HBD-64

Side locking



SVU

Dimensions

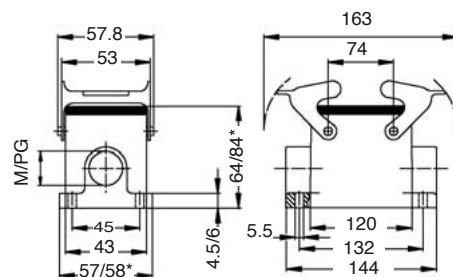

\*HB/HBD

Version	Type	Cat. No.	Qty.
<b>Standard housings, metric thread</b>			
2 x M 25 thread	HDC HB24 SVU 2xM25G	<b>1787870000</b>	2
2 x M 25 thread	HDC HBD64 SVU 2xM25G	<b>1786890000</b>	2
2 x M 32 thread	HDC HBD64 SVU 2xM32G	<b>1786880000</b>	2
<b>Standard housings, PG thread</b>			
1 x Pg21 complete	HDC-HB-24-SVU1/21P	<b>1212500000</b>	2
1 x Pg21 sleeve	HDC-HB-24-SVU1/21	<b>1661510000</b>	2
2 x Pg21 complete	HDC-HB-24-SVU2/21P	<b>1212600000</b>	2
2 x Pg21 sleeve	HDC-HB-24-SVU2/21	<b>1661520000</b>	2
1 x Pg21 complete	HDC-HBD-64-SVU1/21P	<b>1661560000</b>	2
1 x Pg21 sleeve	HDC-HBD-64-SVU1/21	<b>1661570000</b>	2
1 x Pg29 complete	HDC-HBD-64-SVU1/29P	<b>1661600000</b>	2
1 x Pg29 sleeve	HDC-HBD-64-SVU1/29	<b>1661610000</b>	2
2 x Pg21 complete	HDC-HBD-64-SVU2/21P	<b>1661580000</b>	2
2 x Pg21 sleeve	HDC-HBD-64-SVU2/21	<b>1661590000</b>	2
2 x Pg29 complete	HDC-HBD-64-SVU2/29P	<b>1661620000</b>	2
2 x Pg29 sleeve	HDC-HBD-64-SVU2/29	<b>1661630000</b>	2

**SVU** = Base housing, side locking

For accessories see section "Accessories"





# Housings Group Size 8

## Plug hood HB-24

End locking lower side



TOVL



TSVL

Dimensions

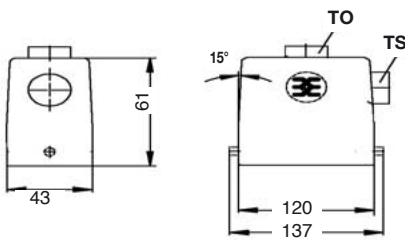

Version	Type	Cat. No.	Qty.
<b>Standard housings, metric thread</b>			
1 x M 25 sleeve	HDC HB24 TSVL 1xM25	1787800000	2
1 x M 32 sleeve	HDC HB24 TSVL 1xM32	1787790000	2
1 x M 25 thread	HDC HB24 TOVL 1xM25G	1787860000	2
1 x M 32 thread	HDC HB24 TOVL 1xM32G	1787850000	2
<b>Standard housings, PG thread</b>			
1 x Pg21 complete	HDC-HB-24-TSVL1/21P	1213800000	2
1 x Pg21 sleeve	HDC-HB-24-TSVL1/21	1662390000	2
1 x Pg29 complete	HDC-HB-24-TSVL1/29P	1662400000	2
1 x Pg29 sleeve	HDC-HB-24-TSVL1/29	1662410000	2
1 x Pg21 complete	HDC-HB-24-TOVL1/21P	1213600000	2
1 x Pg21 sleeve	HDC-HB-24-TOVL1/21	1662540000	2
1 x Pg29 complete	HDC-HB-24-TOVL1/29P	1213700000	2
1 x Pg29 sleeve	HDC-HB-24-TOVL1/29	1662550000	2

**TOVL** Plug hood; Top cable entry, end locking lower side  
**TSVL** = Plug hood; Side cable entry, end locking lower side

## Plug hood HBD-64

End locking lower side / high version



TOVL



TSVL

Dimensions

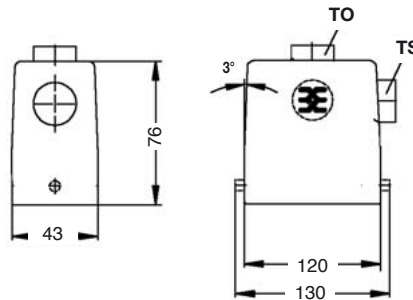

Version	Type	Cat. No.	Qty.
<b>Standard housings, metric thread</b>			
1 x M 25 thread	HDC HBD64 TSVL 1xM25G	1786820000	2
1 x M 32 thread	HDC HBD64 TSVL 1xM32G	1786810000	2
1 x M 25 thread	HDC HBD64 TOVL 1xM25G	1786870000	2
1 x M 32 thread	HDC HBD64 TOVL 1xM32G	1786860000	2
<b>Standard housings, PG thread</b>			
1 x Pg21 complete	HDC-HBD-64-TSVL1/21P	1662460000	2
1 x Pg21 sleeve	HDC-HBD-64-TSVL1/21	1662470000	2
1 x Pg29 complete	HDC-HBD-64-TSVL1/29P	1662480000	2
1 x Pg29 sleeve	HDC-HBD-64-TSVL1/29	1662490000	2
1 x Pg29 complete	HDC-HBD-64-TOVL1/29P	1662620000	2
1 x Pg29 sleeve	HDC-HBD-64-TOVL1/29	1662630000	2

**TOVL** Plug hood; Top cable entry, end locking lower side  
**TSVL** = Plug hood; Side cable entry, end locking lower side

## Base housing HB-24 / HBD-64

End locking / with/without cover



SVL



SDVL

Dimensions

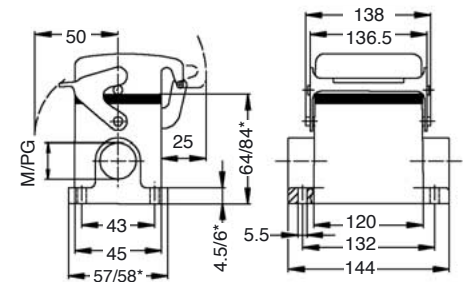

\*HB/HBD

Version	Type	Cat. No.	Qty.
<b>Standard housings, metric thread</b>			
2 x M 25 thread	HDC HB24 SVL 2xM25G	1787880000	2
2 x M 25 thread	HDC HBD64 SVL 2xM25G	1786910000	2
2 x M 32 thread	HDC HBD64 SVL 2xM32G	1786900000	2
2 x M 25 thread	HDC HBD64 SDVL 2xM25G	1786950000	2
2 x M 32 thread	HDC HBD64 SDVL 2xM32G	1786940000	2
<b>Standard housings with cover, metric thread</b>			
2 x M 25 thread	HDC HB24 SDVL 2xM25G	1787900000	2
<b>Standard housings, PG thread</b>			
1 x Pg21 complete	HDC-HB-24-SVL1/21P	1214000000	2
1 x Pg21 sleeve	HDC-HB-24-SVL1/21	1662710000	2
2 x Pg21 complete	HDC-HB-24-SVL2/21P	1214100000	2
2 x Pg21 sleeve	HDC-HB-24-SVL2/21	1662720000	2
2 x Pg21 complete	HDC-HBD-64-SVL2/21P	1662780000	2
<b>Standard housings with cover, PG thread</b>			
1 x Pg21 complete	HDC-HB-24-SDVL1/21P	1214400000	2
1 x Pg21 sleeve	HDC-HB-24-SDVL1/21	1662920000	2
2 x Pg21 complete	HDC-HB-24-SDVL2/21P	1214500000	2
2 x Pg29 sleeve	HDC-HBD-64-SDVL2/29	1663040000	2
1 x Pg21 complete	HDC-HBD-64-SDVL1/21P	1662970000	2
1 x Pg29 complete	HDC-HBD-64-SDVL1/29P	1663010000	2

**SVL** = Base housing, end locking  
**SDVL** = Base housing with cover, end locking

For accessories see section "Accessories"

## Housings Group Size 8

### Coupling hood HB-24 / HBD-64

End locking



**KVL**

### Bulkhead housing HB-24

End locking, with/without cover



**AVL**



**ADVL**

#### Dimensions

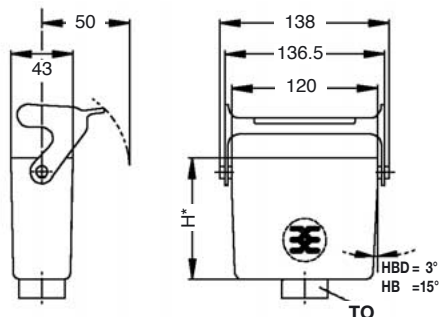

\*HB = 63.8  
HBD = 78.8

Version	Type	Cat. No.	Qty.
<b>Standard housings, metric thread</b>			
1 x M 25 thread	HDC HB24 KVL 1xM25G	<b>1787940000</b>	2
1 x M 32 thread	HDC HB24 KVL 1xM32G	<b>1787930000</b>	2
1 x M 25 thread	HDC HBD64 KVL 1xM25G	<b>1786990000</b>	2
1 x M 32 thread	HDC HBD64 KVL 1xM32G	<b>1786980000</b>	2
<b>Standard housings, PG thread</b>			
1 x Pg21 complete	HDC-HB-24-KVL1/21P	<b>1663130000</b>	2
1 x Pg29 complete	HDC-HB-24-KVL1/29P	<b>1214200000</b>	2
1 x Pg29 complete	HDC-HBD-64-KVL1/29P	<b>1663220000</b>	2

**KVL** = Coupling hood, end locking

#### Dimensions

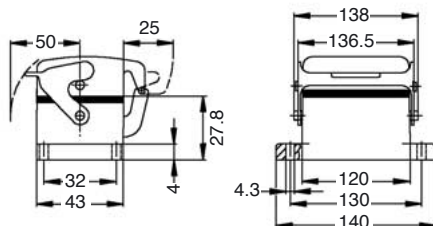

Version	Type	Cat. No.	Qty.
<b>Standard housings</b>			
	HDC-HB-24-AVL	<b>1213900000</b>	2
<b>Standard housings with cover</b>			
	HDC-HB-24-ADVL	<b>1214300000</b>	2

**AVL** = Bulkhead housing, end locking

**ADVL** = Bulkhead housing with cover, end locking

For accessories see section "Accessories"

# Housings Group Size 8

## Plug hood HBD-64

Centre locking



TSVZ

## Base housing HB-24

Centre locking upper side



SVZ

## Bulkhead housing HB-24

Centre locking



AVZ

### Dimensions

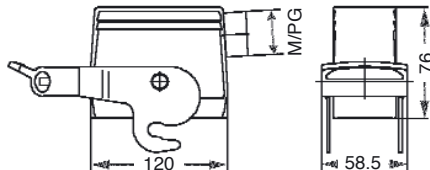

### Dimensions

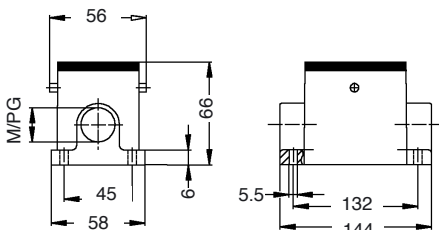

### Dimensions

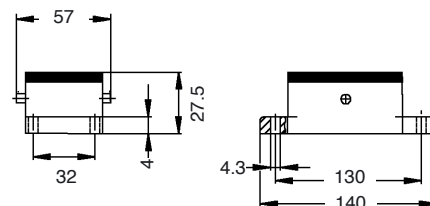

Version	Type	Cat. No.	Qty.
<b>Standard housings, metric thread</b>			
1 x Pg21	complete HDC-HBD-64-TSVZ1/21P	1663360000	2
1 x Pg29	complete HDC-HBD-64-TSVZ1/29P	1603510000	2
1 x Pg29	sleeve HDC-HBD-64-TSVZ1/29	1663390000	2

Version	Type	Cat. No.	Qty.
<b>Standard housings, PG thread</b>			
1 x Pg21	complete HDC-HB-24-SVZ1/21P	1600620000	2

Version	Type	Cat. No.	Qty.
<b>Standard housings</b>			
	HDC-HB-24-AVZ	1611350000	2

TSVZ = Plug hood; Side cable entry, centre locking

SVZ = Base housing, centre locking

AVZ = Bulkhead housing, centre locking

For accessories see section "Accessories"





## Looking for pricing, stock, or lifecycle information?

Click below to explore more details on WIN SOURCE:

 [View 1787000000 on WIN SOURCE](#)

 [Weidmuller Information](#)

## Optimize Your Supply Chain with WIN SOURCE Solutions

-  Global Sourcing Solution
-  Obsolete Management
-  Cost Control Management
-  Shortage Management
-  Alternative Solution
-  Excess Inventory Management