

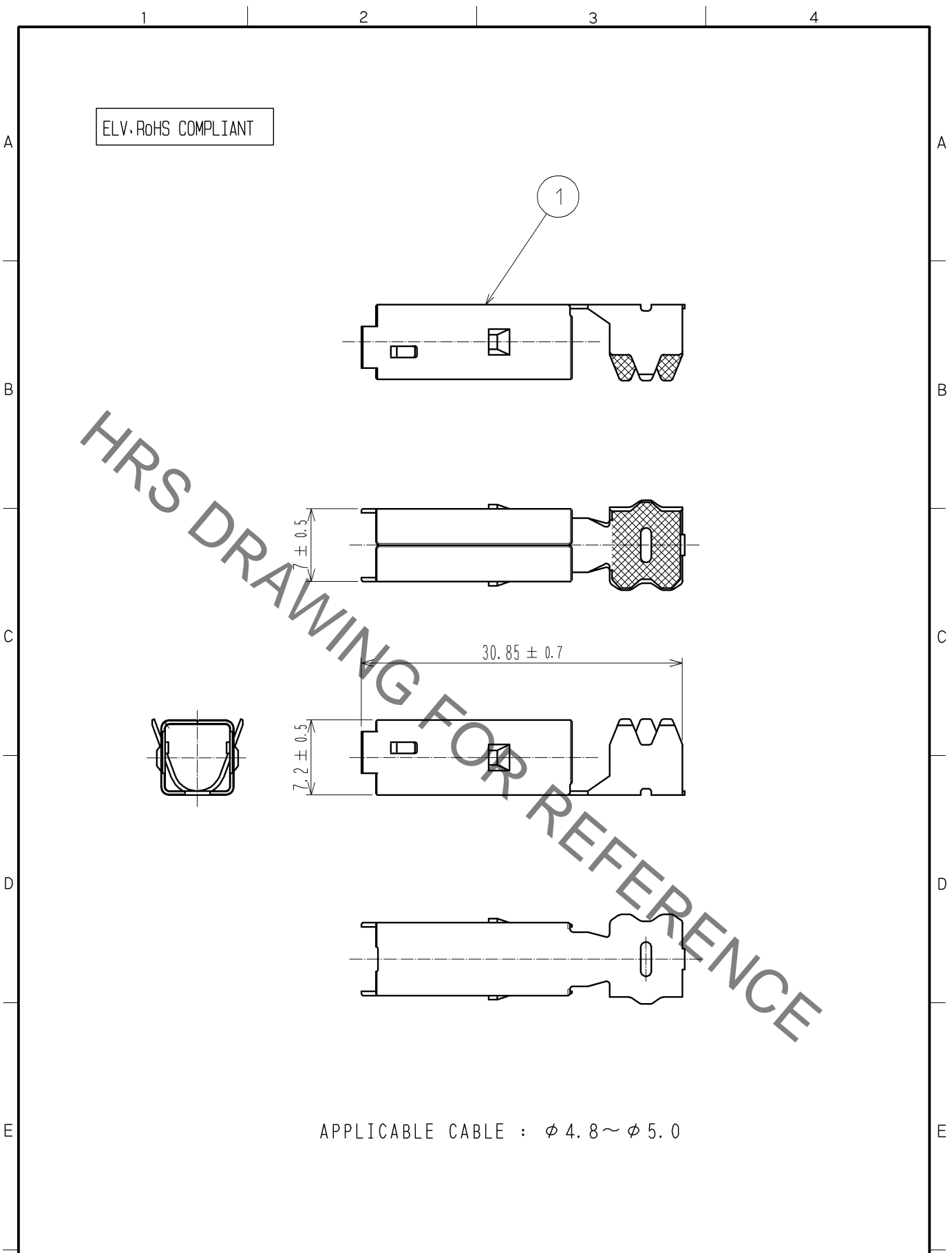

**THE DATASHEET OF
GT17HNFS-4DS-5CF**



Oct.1.2019 Copyright 2019 HIROSE ELECTRIC CO., LTD. All Rights Reserved.
 In case of consideration for using Automotive equipment / device which demand high reliability, kindly contact our sales window correspondents.



APPLICABLE CABLE : ϕ 4.8 ~ ϕ 5.0

1	COPPER ALLOY	TIN PLATED						
NO.	MATERIAL	FINISH .	REMARKS	NO.	MATERIAL	FINISH .	REMARKS	
UNITS mm		SCALE 2 : 1	COUNT 	DESCRIPTION OF REVISIONS		DESIGNED	CHECKED	DATE
HIROSE ELECTRIC CO., LTD.	APPROVED	: NH. NAKATA	14. 12. 24	DRAWING NO.	EDC4-168690-00			
	CHECKED	: NH. NAKATA	14. 12. 24	PART NO.	GT17HNFS-4DS-5CF			
	DESIGNED	: MH. SHOUJI	11. 08. 25	CODE NO.	CL767-0258-5-00		1/1	
	DRAWN	: MH. SHOUJI	11. 08. 25					

Mouser Electronics

Authorized Distributor



Click to View Pricing, Inventory, Delivery & Lifecycle Information:

[Hirose Electric:](#)







[GT17HNFS-4DS-5CF](#)

Looking for pricing, stock, or lifecycle information?

Click below to explore more details on WIN SOURCE:

-  [View GT17HNFS-4DS-5CF on WIN SOURCE](#)
-  [Hirose Electric Co Ltd Information](#)

Optimize Your Supply Chain with WIN SOURCE Solutions

-  Global Sourcing Solution
-  Obsolete Management
-  Cost Control Management
-  Shortage Management
-  Alternative Solution
-  Excess Inventory Management