



**THE DATASHEET OF
DS90LV048ATMTCX**



DS90LV048A 3-V LVDS Quad CMOS Differential Line Receiver

1 Features

- > 400-Mbps (200-MHz) Switching Rates
- Flow-Through Pinout Simplifies PCB Layout
- 150-ps Channel-to-Channel Skew (Typical)
- 100-ps Differential Skew (Typical)
- 2.7-ns Maximum Propagation Delay
- 3.3-V Power Supply Design
- High Impedance LVDS Inputs on Power Down
- Low Power Design (40 mW at 3.3-V Static)
- Interoperable With Existing 5-V LVDS Drivers
- Accepts Small Swing (350 mV Typical) Differential Signal Levels
- Supports Input Failsafe
 - Open, Short, and Terminated
- 0 V to –100 mV Threshold Region
- Conforms to ANSI/TIA/EIA-644 Standard
- Operating Temperature Range: –40°C to +85°C
- Available in SOIC and TSSOP Package

2 Applications

- Multifunction Printers
- LVDS - LVCMOS Translation

3 Description

The DS90LV048A device is a quad CMOS flow-through differential line receiver designed for applications requiring ultra-low power dissipation and high data rates. The device is designed to support data rates in excess of 400 Mbps (200 MHz) using Low Voltage Differential Signaling (LVDS) technology.

The DS90LV048A accepts low voltage (350 mV typical) differential input signals and translates them to 3-V CMOS output levels. The receiver supports a TRI-STATE function that may be used to multiplex outputs. The receiver also supports open, shorted, and terminated (100-Ω) input fail-safe. The receiver output is HIGH for all fail-safe conditions. The DS90LV048A has a flow-through pinout for easy PCB layout.

The EN and EN* inputs are ANDed together and control the TRI-STATE outputs. The enables are common to all four receivers. The DS90LV048A and companion LVDS line driver (for example, DS90LV047A) provide a new alternative to high-power PECL/ECL devices for high-speed point-to-point interface applications.

Device Information⁽¹⁾

PART NUMBER	PACKAGE	BODY SIZE (NOM)
DS90LV048A	SOIC (16)	9.90 mm x 3.91 mm
	TSSOP (16)	5.00 mm x 4.40 mm

(1) For all available packages, see the orderable addendum at the end of the data sheet.

Functional Diagram

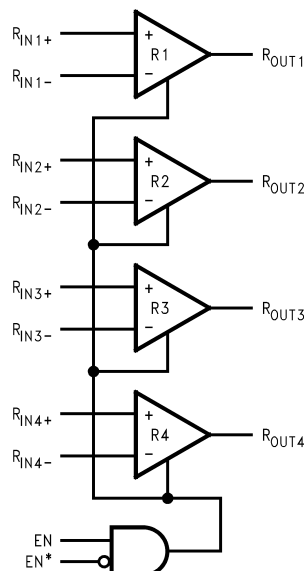

Copyright © 2016, Texas Instruments Incorporated



Table of Contents

1	Features	1	8.3	Feature Description.....	11
2	Applications	1	8.4	Device Functional Modes.....	11
3	Description	1	9	Application and Implementation	12
4	Revision History	2	9.1	Application Information.....	12
5	Pin Configuration and Functions	3	9.2	Typical Application	12
6	Specifications	3	10	Power Supply Recommendations	13
6.1	Absolute Maximum Ratings	3	11	Layout	13
6.2	ESD Ratings.....	4	11.1	Layout Guidelines	13
6.3	Recommended Operating Conditions.....	4	11.2	Layout Example	14
6.4	Thermal Information	4	12	Device and Documentation Support	15
6.5	Electrical Characteristics.....	4	12.1	Documentation Support	15
6.6	Switching Characteristics	5	12.2	Receiving Notification of Documentation Updates	15
6.7	Typical Characteristics	6	12.3	Community Resources.....	15
7	Parameter Measurement Information	9	12.4	Trademarks	15
8	Detailed Description	10	12.5	Electrostatic Discharge Caution.....	15
8.1	Overview	10	12.6	Glossary	15
8.2	Functional Block Diagram	10	13	Mechanical, Packaging, and Orderable Information	15

4 Revision History

NOTE: Page numbers for previous revisions may differ from page numbers in the current version.

Changes from Revision B (April 2013) to Revision C	Page
<ul style="list-style-type: none"> Added <i>ESD Ratings</i> table, <i>Thermal Information</i> table, <i>Feature Description</i> section, <i>Device Functional Modes</i>, <i>Application and Implementation</i> section, <i>Power Supply Recommendations</i> section, <i>Layout</i> section, <i>Device and Documentation Support</i> section, and <i>Mechanical, Packaging, and Orderable Information</i> section..... 	1

Changes from Revision A (April 2013) to Revision B	Page
<ul style="list-style-type: none"> Changed layout of National Semiconductor Data Sheet to TI format 	8

5 Pin Configuration and Functions

D or PW Package
16-Pin SOIC or TSSOP
Top View

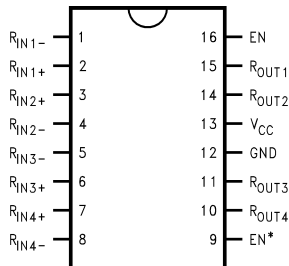

Pin Functions

PIN		I/O	DESCRIPTION
NAME	NO.		
EN	16	I	Receiver enable pin: When EN is low, the receiver is disabled. When EN is high and EN* is low or open, the receiver is enabled. If both EN and EN* are open circuit, then the receiver is disabled.
EN*	9	I	Receiver enable pin: When EN* is high, the receiver is disabled. When EN* is low or open and EN is high, the receiver is enabled. If both EN and EN* are open circuit, then the receiver is disabled.
GND	12	—	Ground pin
R _{IN+}	2, 3, 6, 7	I	Noninverting receiver input pin
R _{IN-}	1, 4, 5, 8	I	Inverting receiver input pin
R _{OUT}	10, 11, 14, 15	O	Receiver output pin
V _{CC}	13	—	Power supply pin, +3.3V ± 0.3V

6 Specifications

6.1 Absolute Maximum Ratings

See ⁽¹⁾⁽²⁾

		MIN	MAX	UNIT
Supply voltage (V _{CC})		-0.3	4	V
Input voltage (R _{IN+} , R _{IN-})		-0.3	3.6	V
Enable input voltage (EN, EN*)		-0.3	V _{CC} + 0.3	V
Output voltage (R _{OUT})		-0.3	V _{CC} + 0.3	V
Maximum package power dissipation at +25°C	D0016A package		1025	mW
	PW0016A package		866	
	Derate D0016A package	above +25°C	8.2	mW/°C
	Derate PW0016A package	above +25°C	6.9	
Lead temperature soldering	(4 s)		260	°C
Maximum junction temperature			150	°C
Storage temperature, T _{stg}		-65	150	°C

- (1) Stresses beyond those listed under *Absolute Maximum Ratings* may cause permanent damage to the device. These are stress ratings only, which do not imply functional operation of the device at these or any other conditions beyond those indicated under *Recommended Operating Conditions*. Exposure to absolute-maximum-rated conditions for extended periods may affect device reliability.
- (2) If Military/Aerospace specified devices are required, please contact the Texas Instruments Sales Office/Distributors for availability and specifications.

6.2 ESD Ratings

		VALUE	UNIT
$V_{(ESD)}$	Electrostatic discharge ⁽¹⁾	Human-body model (HBM)	±10000
		Machine model	±1200

- (1) ESD Rating:
 HBM (1.5 k Ω , 100 pF)
 EIAJ (0 Ω , 200 pF)

6.3 Recommended Operating Conditions

	MIN	NOM	MAX	UNIT
Supply voltage, V_{CC}	3	3.3	3.6	V
Receiver input voltage	GND		3	V
Operating free air temperature, T_A	-40	25	85	°C

6.4 Thermal Information

THERMAL METRIC ⁽¹⁾		DS90LV048A	UNIT
		PW (TSSOP)	
		16 PINS	
$R_{\theta JA}$	Junction-to-ambient thermal resistance	110.2	°C/W
$R_{\theta JC(top)}$	Junction-to-case (top) thermal resistance	47	°C/W
$R_{\theta JB}$	Junction-to-board thermal resistance	54.7	°C/W
Ψ_{JT}	Junction-to-top characterization parameter	6.1	°C/W
Ψ_{JB}	Junction-to-board characterization parameter	54.2	°C/W

- (1) For more information about traditional and new thermal metrics, see the [Semiconductor and IC Package Thermal Metrics](#) application report.

6.5 Electrical Characteristics

Over Supply Voltage and Operating Temperature ranges, unless otherwise specified.⁽¹⁾⁽²⁾

PARAMETER	TEST CONDITIONS	PIN	MIN	TYP	MAX	UNIT	
V_{TH}	Differential input high threshold	R_{IN+} R_{IN-}		-35	0	mV	
V_{TL}	Differential input low threshold			-100	-35	mV	
V_{CMR}	Common-mode voltage range			0.1		2.3	V
I_{IN}	Input current	$V_{CC} = 3.6$ V or 0 V	$V_{IN} = +2.8$ V	-10	±5	10	μ A
			$V_{IN} = 0$ V	-10	±1	10	
			$V_{IN} = +3.6$ V	-20	±1	20	
V_{OH}	Output high voltage	R_{OUT}	$I_{OH} = -0.4$ mA, $V_{ID} = +200$ mV	2.7	3.3	V	
			$I_{OH} = -0.4$ mA, input terminated	2.7	3.3		
			$I_{OH} = -0.4$ mA, input shorted	2.7	3.3		
V_{OL}	Output low voltage			0.05	0.25	V	
I_{OS}	Output short-circuit current		-15	-47	-100	mA	
I_{OZ}	Output TRI-STATE current		-10	±1	10	μ A	

- (1) Current into device pins is defined as positive. Current out of device pins is defined as negative. All voltages are referenced to ground unless otherwise specified.
- (2) All typicals are given for: $V_{CC} = 3.3$ V, $T_A = 25^\circ$ C.
- (3) V_{CC} is always higher than R_{IN+} and R_{IN-} voltage. R_{IN-} and R_{IN+} are allowed to have a voltage range -0.2 V to $V_{CC} - VID/2$. However, to be compliant with AC specifications, the common voltage range is 0.1 V to 2.3 V.
- (4) The V_{CMR} range is reduced for larger VID . Example: if $VID = 400$ mV, the V_{CMR} is 0.2 V to 2.2 V. The fail-safe condition with inputs shorted is not supported over the common-mode range of 0 V to 2.4 V, but is supported only with inputs shorted and no external common-mode voltage applied. A VID up to $V_{CC} - 0$ V may be applied to the R_{IN+}/R_{IN-} inputs with the Common-Mode voltage set to $V_{CC}/2$. Propagation delay and Differential Pulse skew decrease when VID is increased from 200 mV to 400 mV. Skew specifications apply for 200 mV $\leq VID \leq 800$ mV over the common-mode range.
- (5) Output short-circuit current (I_{OS}) is specified as magnitude only; minus sign indicates direction only. Only one output should be shorted at a time; do not exceed maximum junction temperature specification.

Electrical Characteristics (continued)

Over Supply Voltage and Operating Temperature ranges, unless otherwise specified.⁽¹⁾⁽²⁾

PARAMETER		TEST CONDITIONS	PIN	MIN	TYP	MAX	UNIT
V _{IH}	Input high voltage		EN, EN*	2		V _{CC}	V
V _{IL}	Input low voltage			GND		0.8	V
I _I	Input current	V _{IN} = 0 V or V _{CC} , other Input = V _{CC} or GND		-10	±5	10	μA
V _{CL}	Input clamp voltage	I _{CL} = -18 mA		-1.5	-0.8		V
I _{CC}	No load supply current receivers enabled	EN = V _{CC} , inputs open	V _{CC}		9	15	mA
I _{CCZ}	No load supply current receivers disabled	EN = GND, inputs open			1	5	mA

6.6 Switching Characteristics

Over Supply Voltage and Operating Temperature ranges, unless otherwise specified.⁽¹⁾⁽²⁾⁽³⁾⁽⁴⁾

PARAMETER		TEST CONDITIONS	MIN	TYP	MAX	UNIT	
t _{PHLD}	Differential propagation delay high to low	C _L = 15 pF V _{ID} = 200 mV (Figure 15 and Figure 16)	1.2	2	2.7	ns	
t _{PLHD}	Differential propagation delay low to high		1.2	1.9	2.7	ns	
t _{SKD1}	Differential pulse skew t _{PHLD} - t _{PLHD} ⁽⁵⁾		0	0.1	0.4	ns	
t _{SKD2}	Differential channel-to-channel skew; same device ⁽³⁾		0	0.15	0.5	ns	
t _{SKD3}	Differential part-to-part skew ⁽⁴⁾				1	ns	
t _{SKD4}	Differential part-to-part skew ⁽⁶⁾				1.5	ns	
t _{TLH}	Rise time			0.5	1	ns	
t _{THL}	Fall time			0.35	1	ns	
t _{PHZ}	Disable time high to Z		R _L = 2 kΩ C _L = 15 pF (Figure 17 and Figure 18)		8	14	ns
t _{PLZ}	Disable time low to Z				8	14	ns
t _{PZH}	Enable time Z to high				9	14	ns
t _{PZL}	Enable time Z to low				9	14	ns
f _{MAX}	Maximum operating frequency ⁽⁷⁾		All channels switching	200	250		MHz

(1) All typicals are given for: V_{CC} = 3.3 V, T_A = 25°C.

(2) Generator waveform for all tests unless otherwise specified: f = 1 MHz, Z_O = 50 Ω, t_r and t_f (0% to 100%) ≤ 3 ns for R_{IN}.

(3) t_{SKD2}, channel-to-channel skew is defined as the difference between the propagation delay of one channel and that of the others on the same chip with any event on the inputs.

(4) t_{SKD3}, part-to-part skew, is the differential channel-to-channel skew of any event between devices. This specification applies to devices at the same V_{CC}, and within 5°C of each other within the operating temperature range.

(5) t_{SKD1} is the magnitude difference in differential propagation delay time between the positive going edge and the negative going edge of the same channel

(6) t_{SKD4}, part-to-part skew, is the differential channel-to-channel skew of any event between devices. This specification applies to devices over recommended operating temperature and voltage ranges, and across process distribution. t_{SKD4} is defined as |Max-Min| differential propagation delay.

(7) f_{MAX} generator input conditions: t_r = t_f < 1 ns (0% to 100%), 50% duty cycle, differential (1.05-V to 1.35-V peak to peak). Output criteria: 60 / 40% duty cycle, V_{OL} (maximum 0.4 V), V_{OH} (minimum 2.7 V), Load = 15 pF (stray plus probes).

6.7 Typical Characteristics

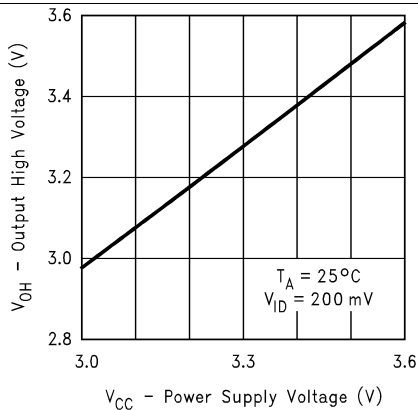

Figure 1. Output High Voltage vs Power Supply Voltage

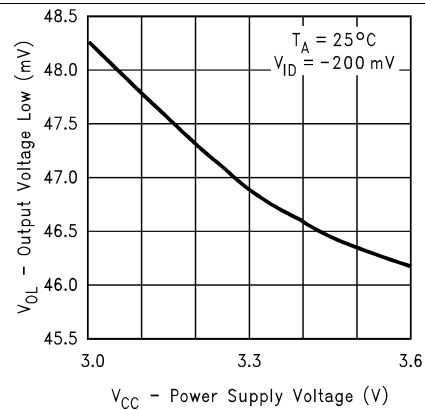

Figure 2. Output Low Voltage vs Power Supply Voltage

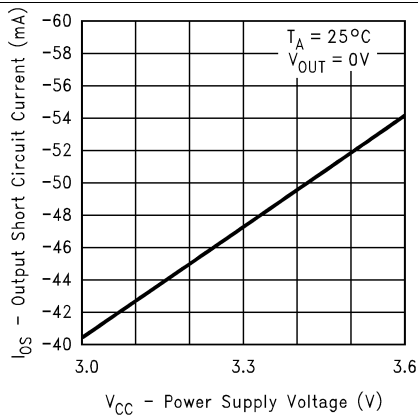

Figure 3. Output Short-Circuit Current vs Power Supply Voltage

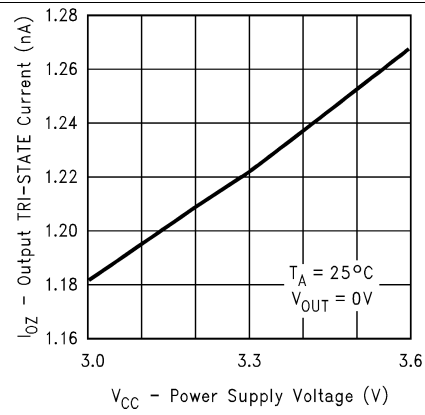

Figure 4. Output TRI-STATE Current vs Power Supply Voltage

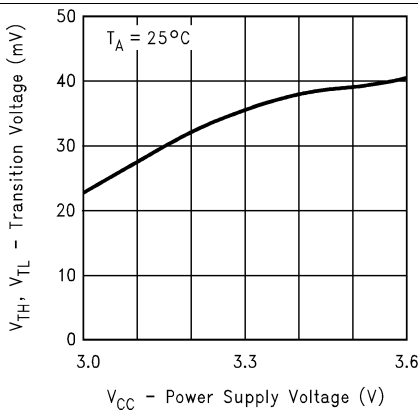

Figure 5. Differential Transition Voltage vs Power Supply Voltage

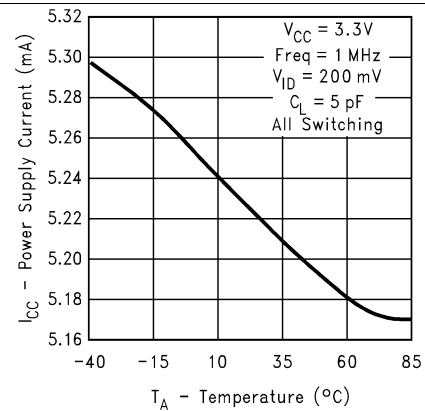

Figure 6. Power Supply Current vs Ambient Temperature

Typical Characteristics (continued)

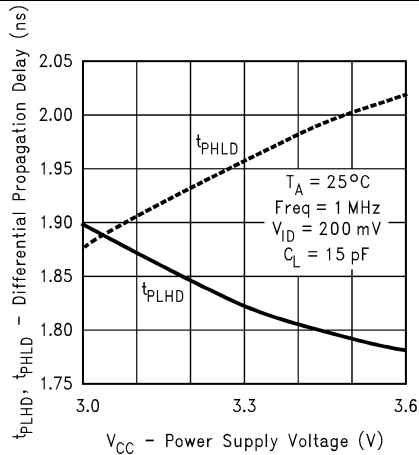

Figure 7. Differential Propagation Delay vs Power Supply Voltage

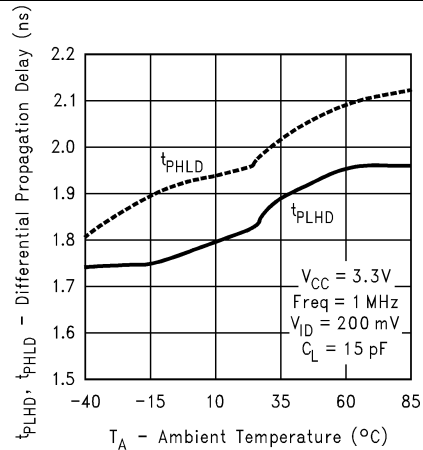

Figure 8. Differential Propagation Delay vs Ambient Temperature

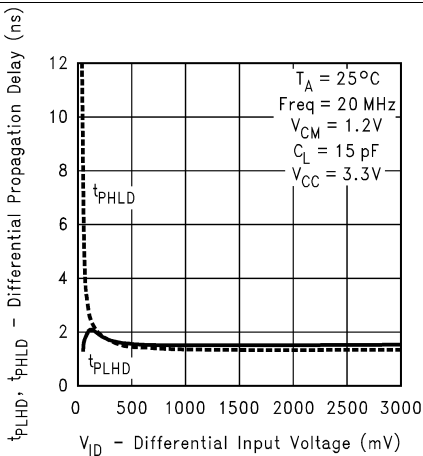

Figure 9. Differential Propagation Delay vs Differential Input Voltage

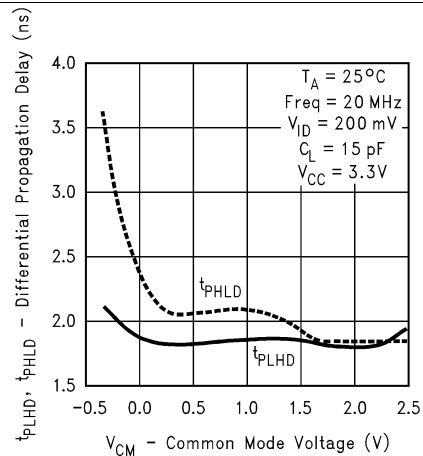

Figure 10. Differential Propagation Delay vs Common-Mode Voltage

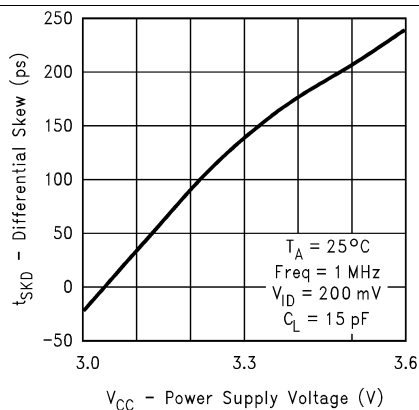

Figure 11. Differential Skew vs Power Supply Voltage

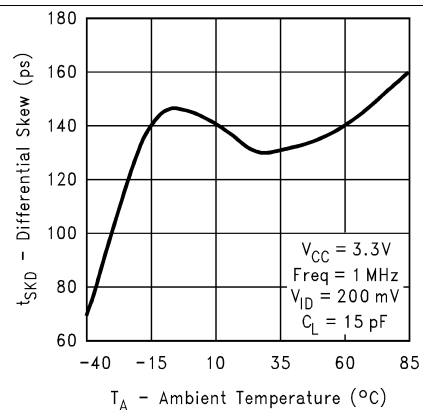
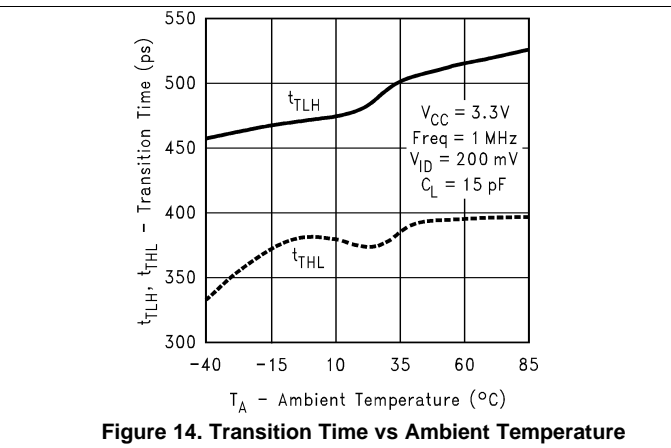
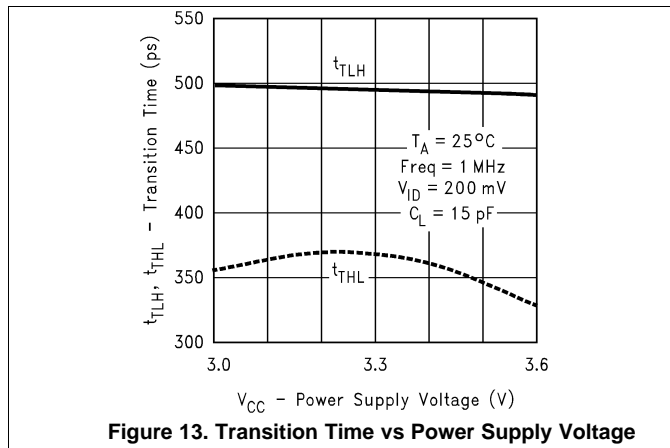

Figure 12. Differential Skew vs Ambient Temperature

Typical Characteristics (continued)

7 Parameter Measurement Information

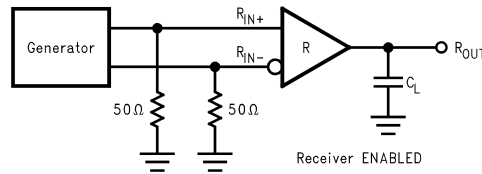

Figure 15. Receiver Propagation Delay and Transition Time Test Circuit

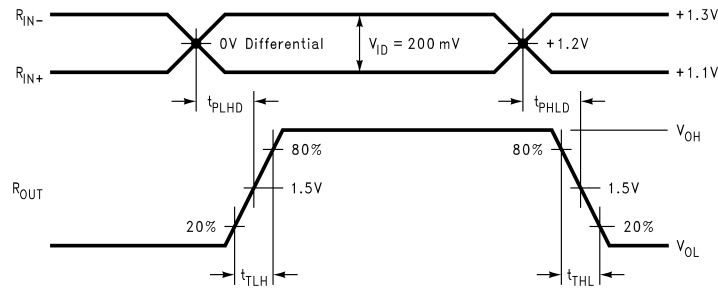
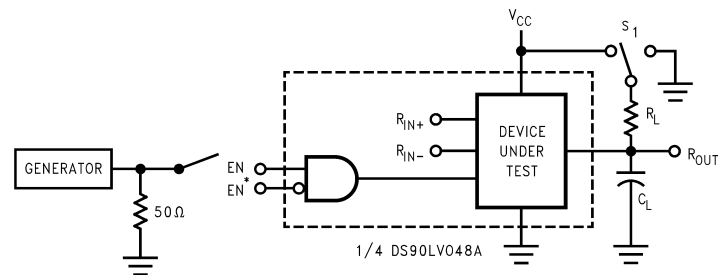

Figure 16. Receiver Propagation Delay and Transition Time Waveforms



C_L includes load and test jig capacitance.
 $S_1 = V_{CC}$ for t_{PZL} and t_{PLZ} measurements.
 $S_1 = GND$ for t_{PZH} and t_{PHZ} measurements.

Figure 17. Receiver TRI-STATE Delay Test Circuit

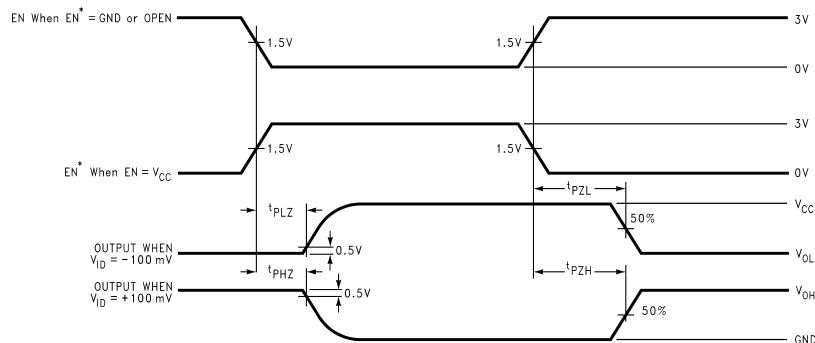

Figure 18. Receiver TRI-STATE Delay Waveforms

8 Detailed Description

8.1 Overview

LVDS drivers and receivers are intended to be primarily used in an uncomplicated point-to-point configuration as shown in Figure 19. This configuration provides a clean signaling environment for the fast edge rates of the drivers. The receiver is connected to the driver through a balanced media which may be a standard twisted pair cable, a parallel pair cable, or simply PCB traces. Typically, the characteristic impedance of the media is in the range of 100 Ω . A termination resistor of 100 Ω (selected to match the media) is located as close to the receiver input pins as possible. The termination resistor converts the driver output (current mode) into a voltage that is detected by the receiver. Other configurations are possible such as a multi-receiver configuration, but the effects of a mid-stream connector(s), cable stub(s), and other impedance discontinuities as well as ground shifting, noise margin limits, and total termination loading must be considered.

The DS90LV048A differential line receiver is capable of detecting signals as low as 100 mV, over a ± 1 -V common-mode range centered around +1.2 V. This is related to the driver offset voltage which is typically +1.2 V. The driven signal is centered around this voltage and may shift ± 1 V around this center point. The ± 1 -V shifting may be the result of a ground potential difference between the ground reference of the driver and the ground reference of the receiver, the common-mode effects of coupled noise, or a combination of the two. The AC parameters of both receiver input pins are optimized for a recommended operating input voltage range of 0 V to +2.4 V (measured from each pin to ground). The device operates for receiver input voltages up to V_{CC} , but exceeding V_{CC} turns on the ESD protection circuitry, which clamps the bus voltages.

The DS90LV048A has a flow-through pinout that allows for easy PCB layout. The LVDS signals on one side of the device easily allows for matching electrical lengths of the differential pair trace lines between the driver and the receiver as well as allowing the trace lines to be close together to couple noise as common-mode. Noise isolation is achieved with the LVDS signals on one side of the device and the TTL signals on the other side.

8.2 Functional Block Diagram

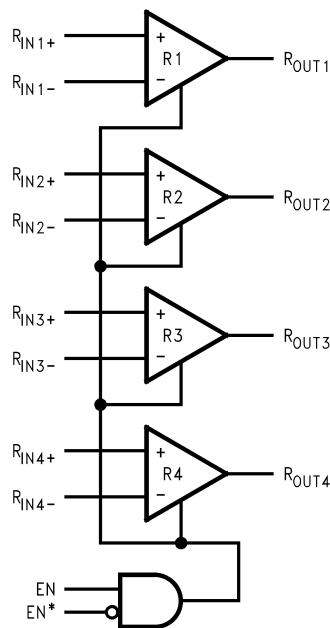

Copyright © 2016, Texas Instruments Incorporated

8.3 Feature Description

8.3.1 Fail-Safe Feature

The LVDS receiver is a high-gain, high-speed device that amplifies a small differential signal (20 mV) to CMOS logic levels. Due to the high gain and tight threshold of the receiver, take care to prevent noise from appearing as a valid signal.

The internal fail-safe circuitry of the receiver is designed to source or sink a small amount of current, providing fail-safe protection (a stable known state of HIGH output voltage) for floating, terminated or shorted receiver inputs.

1. **Open Input Pins.** The DS90LV048A is a quad receiver device, and if an application requires only 1, 2, or 3 receivers, the unused channel(s) inputs must be left OPEN. Do not tie unused receiver inputs to ground or any other voltages. The input is biased by internal high value pullup and pulldown resistors to set the output to a HIGH state. This internal circuitry ensures a HIGH, stable output state for open inputs.
2. **Terminated Input.** If the driver is disconnected (cable unplugged), or if the driver is in a TRI-STATE or power-off condition, the receiver output is again in a HIGH state, even with the end of cable 100-Ω termination resistor across the input pins. The unplugged cable can become a floating antenna which can pick up noise. If the cable picks up more than 10 mV of differential noise, the receiver may see the noise as a valid signal and switch. To ensure that any noise is seen as common-mode and not differential, a balanced interconnect should be used. Twisted pair cable offers better balance than flat ribbon cable.
3. **Shorted Inputs.** If a fault condition occurs that shorts the receiver inputs together, thus resulting in a 0-V differential input voltage, the receiver output remains in a HIGH state. Shorted input fail-safe is not supported across the common-mode range of the device (GND to 2.4 V). It is only supported with inputs shorted and no external common-mode voltage applied.

External lower value pullup and pulldown resistors (for a stronger bias) may be used to boost fail-safe in the presence of higher noise levels. The pullup and pulldown resistors must be in the 5-kΩ to 15-kΩ range to minimize loading and waveform distortion to the driver. The common-mode bias point must be set to approximately 1.2 V (less than 1.75 V) to be compatible with the internal circuitry.

Additional information on fail-safe biasing of LVDS devices may be found in [AN-1194 Failsafe Biasing of LVDS Interfaces](#) (SNLA051).

8.4 Device Functional Modes

[Table 1](#) lists the functional modes of the DS90LV048A.

Table 1. Truth Table

ENABLES		INPUT	OUTPUT
EN	EN*	R _{IN+} – R _{IN-}	R _{OUT}
H	L or Open	V _{ID} ≥ 0 V	H
		V _{ID} ≤ -0.1 V	L
		Full Fail-safe OPEN/SHORT or Terminated	H
All other combinations of ENABLE inputs		X	Z

9 Application and Implementation

NOTE

Information in the following applications sections is not part of the TI component specification, and TI does not warrant its accuracy or completeness. TI's customers are responsible for determining suitability of components for their purposes. Customers should validate and test their design implementation to confirm system functionality.

9.1 Application Information

The DS90LV048A has a flow-through pinout that allows for easy PCB layout. The LVDS signals on one side of the device easily allows for matching electrical lengths of the differential pair trace lines between the driver and the receiver as well as allowing the trace lines to be close together to couple noise as common-mode. Noise isolation is achieved with the LVDS signals on one side of the device and the TTL signals on the other side.

9.2 Typical Application

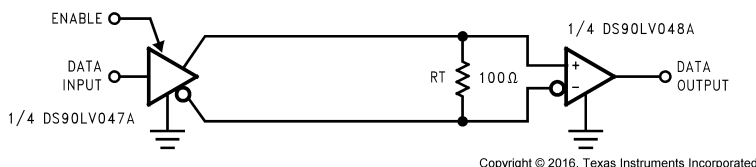

Figure 19. Balanced System Point-to-Point Application

9.2.1 Design Requirements

When using LVDS devices, it is important to remember to specify controlled impedance PCB traces, cable assemblies, and connectors. All components of the transmission media must have a matched differential impedance of about 100 Ω . They must not introduce major impedance discontinuities.

Balanced cables (for example, twisted pair) are usually better than unbalanced cables (ribbon cable) for noise reduction and signal quality. Balanced cables tend to generate less EMI due to field canceling effects and also tend to pick up electromagnetic radiation as common-mode (not differential mode) noise which is rejected by the LVDS receiver.

For cable distances < 0.5 M, most cables can be made to work effectively. For distances $0.5 \text{ M} \leq d \leq 10 \text{ M}$, CAT5 (Category 5) twisted pair cable works well, is readily available, and relatively inexpensive.

9.2.2 Detailed Design Procedure

9.2.2.1 Probing LVDS Transmission Lines

Always use high impedance ($> 100\text{k}\Omega$), low capacitance ($< 2 \text{ pF}$) scope probes with a wide bandwidth (1 GHz) scope. Improper probing gives deceiving results.

9.2.2.2 Threshold

The LVDS Standard (ANSI/TIA/EIA-644) specifies a maximum threshold of $\pm 100 \text{ mV}$ for the LVDS receiver. The DS90LV048A supports an enhanced threshold region of -100 mV to 0 V . This is useful for fail-safe biasing. The threshold region is shown in the Voltage Transfer Curve (VTC) in [Figure 20](#). The typical DS90LV048A LVDS receiver switches at about -35 mV .

NOTE

With $V_{ID} = 0 \text{ V}$, the output is in a HIGH state. With an external fail-safe bias of $+25 \text{ mV}$ applied, the typical differential noise margin is now the difference from the switch point to the bias point.

In the following example, this would be 60 mV of Differential Noise Margin ($+25 \text{ mV} - (-35 \text{ mV})$). With the enhanced threshold region of -100 mV to 0 V , this small external fail-safe biasing of $+25 \text{ mV}$ (with respect to

Typical Application (continued)

0 V) gives a DNM of a comfortable 60 mV. With the standard threshold region of ± 100 mV, the external fail-safe biasing would need to be +25 mV with respect to +100 mV or +125 mV, giving a DNM of 160 mV which is stronger fail-safe biasing than is necessary for the DS90LV048A. If more DNM is required, then a stronger fail-safe bias point can be set by changing resistor values.

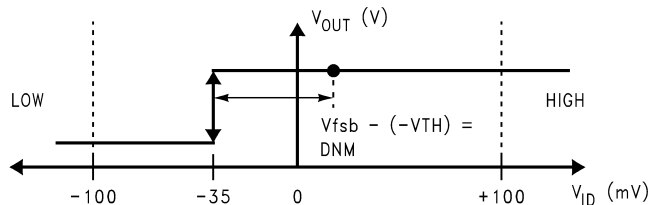

Figure 20. VTC of the DS90LV048A LVDS Receiver

9.2.3 Application Curve

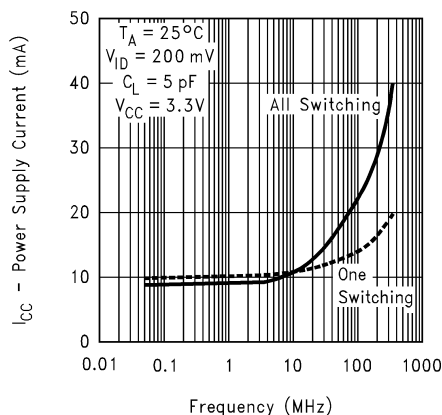

Figure 21. Power Supply Current vs Frequency

10 Power Supply Recommendations

Although the DS90LV047A draws very little power while at rest, its overall power consumption increases due to a dynamic current component. The DS90LV048A power supply connection must take this additional current consumption into consideration for maximum power requirements.

11 Layout

11.1 Layout Guidelines

- Use at least 4 PCB layers (top to bottom): LVDS signals, ground, power, and TTL signals.
- Isolate TTL signals from LVDS signals, otherwise the TTL may couple onto the LVDS lines. Best practice is to put TTL and LVDS signals on different layers which are isolated by a power/ground plane(s).
- Keep drivers and receivers as close to the (LVDS port side) connectors as possible.

11.1.1 Power Decoupling Recommendations

Bypass capacitors must be used on power pins. Use high-frequency ceramic (surface mount is recommended) 0.1- μ F and 0.001- μ F capacitors in parallel at the power supply pin with the smallest value capacitor closest to the device supply pin. Additional scattered capacitors over the printed-circuit board improves decoupling. Multiple vias must be used to connect the decoupling capacitors to the power planes. A 10- μ F (35-V) or greater solid tantalum capacitor must be connected at the power entry point on the printed-circuit board between the supply and ground.

Layout Guidelines (continued)

11.1.2 Differential Traces

Use controlled impedance traces that match the differential impedance of your transmission medium (that is, cable) and termination resistor. Run the differential pair trace lines as close together as possible as soon as they leave the IC (stubs must be < 10 mm long). This helps eliminate reflections and ensure noise is coupled as common-mode. In fact, we have seen that differential signals which are 1 mm apart radiate far less noise than traces 3 mm apart because magnetic field cancellation is much better with the closer traces. In addition, noise induced on the differential lines is much more likely to appear as common-mode which is rejected by the receiver.

Match electrical lengths between traces to reduce skew. Skew between the signals of a pair means a phase difference between signals, which destroys the magnetic field cancellation benefits of differential signals and EMI, results. Remember the velocity of propagation, $v = c/Er$ where c (the speed of light) = 0.2997 mm/ps or 0.0118 in/ps.

Do not rely solely on the autoroute function for differential traces. Carefully review dimensions to match differential impedance and provide isolation for the differential lines. Minimize the number of vias and other discontinuities on the line.

Avoid 90° turns (these cause impedance discontinuities). Use arcs or 45° bevels.

Within a pair of traces, the distance between the two traces should be minimized to maintain common-mode rejection of the receivers. On the printed-circuit board, this distance must remain constant to avoid discontinuities in differential impedance. Minor violations at connection points are allowable.

11.1.3 Termination

Use a termination resistor that best matches the differential impedance of your transmission line. The resistor must be between 90 Ω and 130 Ω. Remember that the current mode outputs need the termination resistor to generate the differential voltage. LVDS does not work without resistor termination. Typically, connecting a single resistor across the pair at the receiver end will suffice.

Surface mount 1% to 2% resistors are best. PCB stubs, component lead, and the distance from the termination to the receiver inputs must be minimized. The distance between the termination resistor and the receiver must be < 10 mm (12 mm maximum).

11.2 Layout Example

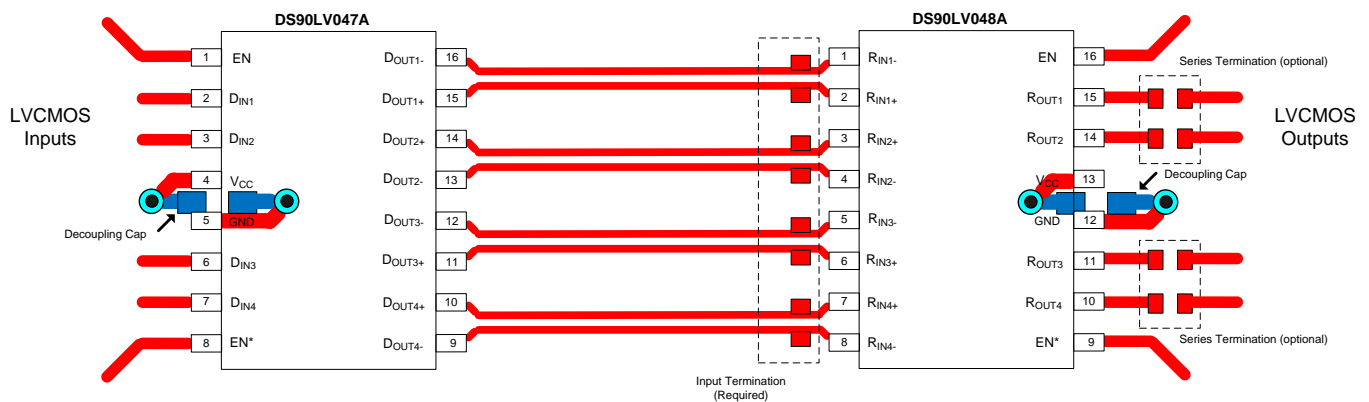

Figure 22. Layout Recommendation

12 Device and Documentation Support

12.1 Documentation Support

12.1.1 Related Documentation

For related documentation, see the following:

- [LVDS Owner's Manual](#) (SNLA187)
- [AN-808 Long Transmission Lines and Data Signal Quality](#) (SNLA028)
- [AN-977 LVDS Signal Quality: Jitter Measurements Using Eye Patterns Test Report #1](#)(SNLA166)
- [AN-971 An Overview of LVDS Technology](#) (SNLA165)
- [AN-916 A Practical Guide to Cable Selection](#) (SNLA219)
- [AN-805 Calculating Power Dissipation for Differential Line Drivers](#) (SNOA233)
- [AN-903 A Comparison of Differential Termination Techniques](#) (SNLA034)
- [AN-1194 Failsafe Biasing of LVDS Interfaces](#) (SNLA051)

12.2 Receiving Notification of Documentation Updates

To receive notification of documentation updates, navigate to the device product folder on ti.com. In the upper right corner, click on *Alert me* to register and receive a weekly digest of any product information that has changed. For change details, review the revision history included in any revised document.

12.3 Community Resources

The following links connect to TI community resources. Linked contents are provided "AS IS" by the respective contributors. They do not constitute TI specifications and do not necessarily reflect TI's views; see TI's [Terms of Use](#).

TI E2E™ Online Community *TI's Engineer-to-Engineer (E2E) Community*. Created to foster collaboration among engineers. At e2e.ti.com, you can ask questions, share knowledge, explore ideas and help solve problems with fellow engineers.

Design Support *TI's Design Support* Quickly find helpful E2E forums along with design support tools and contact information for technical support.

12.4 Trademarks

E2E is a trademark of Texas Instruments.
All other trademarks are the property of their respective owners.

12.5 Electrostatic Discharge Caution



These devices have limited built-in ESD protection. The leads should be shorted together or the device placed in conductive foam during storage or handling to prevent electrostatic damage to the MOS gates.

12.6 Glossary

[SLYZ022](#) — *TI Glossary*.

This glossary lists and explains terms, acronyms, and definitions.

13 Mechanical, Packaging, and Orderable Information

The following pages include mechanical, packaging, and orderable information. This information is the most current data available for the designated devices. This data is subject to change without notice and revision of this document. For browser-based versions of this data sheet, refer to the left-hand navigation.

PACKAGING INFORMATION

Orderable Device	Status (1)	Package Type	Package Drawing	Pins	Package Qty	Eco Plan (2)	Lead/Ball Finish (6)	MSL Peak Temp (3)	Op Temp (°C)	Device Marking (4/5)	Samples
DS90LV048ATM	NRND	SOIC	D	16	48	TBD	Call TI	Call TI	-40 to 85	DS90LV048A TM	
DS90LV048ATM/NOPB	ACTIVE	SOIC	D	16	48	Green (RoHS & no Sb/Br)	CU SN	Level-1-260C-UNLIM	-40 to 85	DS90LV048A TM	Samples
DS90LV048ATMTC	NRND	TSSOP	PW	16	92	TBD	Call TI	Call TI	-40 to 85	DS90LV 048AT	
DS90LV048ATMTC/NOPB	ACTIVE	TSSOP	PW	16	92	Green (RoHS & no Sb/Br)	CU SN	Level-1-260C-UNLIM	-40 to 85	DS90LV 048AT	Samples
DS90LV048ATMTCX	NRND	TSSOP	PW	16	2500	TBD	Call TI	Call TI	-40 to 85	DS90LV 048AT	
DS90LV048ATMTCX/NOPB	ACTIVE	TSSOP	PW	16	2500	Green (RoHS & no Sb/Br)	CU SN	Level-1-260C-UNLIM	-40 to 85	DS90LV 048AT	Samples
DS90LV048ATMX/NOPB	ACTIVE	SOIC	D	16	2500	Green (RoHS & no Sb/Br)	CU SN	Level-1-260C-UNLIM	-40 to 85	DS90LV048A TM	Samples

(1) The marketing status values are defined as follows:

ACTIVE: Product device recommended for new designs.

LIFEBUY: TI has announced that the device will be discontinued, and a lifetime-buy period is in effect.

NRND: Not recommended for new designs. Device is in production to support existing customers, but TI does not recommend using this part in a new design.

PREVIEW: Device has been announced but is not in production. Samples may or may not be available.

OBSELETE: TI has discontinued the production of the device.

(2) Eco Plan - The planned eco-friendly classification: Pb-Free (RoHS), Pb-Free (RoHS Exempt), or Green (RoHS & no Sb/Br) - please check <http://www.ti.com/productcontent> for the latest availability information and additional product content details.

TBD: The Pb-Free/Green conversion plan has not been defined.

Pb-Free (RoHS): TI's terms "Lead-Free" or "Pb-Free" mean semiconductor products that are compatible with the current RoHS requirements for all 6 substances, including the requirement that lead not exceed 0.1% by weight in homogeneous materials. Where designed to be soldered at high temperatures, TI Pb-Free products are suitable for use in specified lead-free processes.

Pb-Free (RoHS Exempt): This component has a RoHS exemption for either 1) lead-based flip-chip solder bumps used between the die and package, or 2) lead-based die adhesive used between the die and leadframe. The component is otherwise considered Pb-Free (RoHS compatible) as defined above.

Green (RoHS & no Sb/Br): TI defines "Green" to mean Pb-Free (RoHS compatible), and free of Bromine (Br) and Antimony (Sb) based flame retardants (Br or Sb do not exceed 0.1% by weight in homogeneous material)

(3) MSL, Peak Temp. - The Moisture Sensitivity Level rating according to the JEDEC industry standard classifications, and peak solder temperature.

(4) There may be additional marking, which relates to the logo, the lot trace code information, or the environmental category on the device.

⁽⁵⁾ Multiple Device Markings will be inside parentheses. Only one Device Marking contained in parentheses and separated by a "-" will appear on a device. If a line is indented then it is a continuation of the previous line and the two combined represent the entire Device Marking for that device.

⁽⁶⁾ Lead/Ball Finish - Orderable Devices may have multiple material finish options. Finish options are separated by a vertical ruled line. Lead/Ball Finish values may wrap to two lines if the finish value exceeds the maximum column width.

Important Information and Disclaimer:The information provided on this page represents TI's knowledge and belief as of the date that it is provided. TI bases its knowledge and belief on information provided by third parties, and makes no representation or warranty as to the accuracy of such information. Efforts are underway to better integrate information from third parties. TI has taken and continues to take reasonable steps to provide representative and accurate information but may not have conducted destructive testing or chemical analysis on incoming materials and chemicals. TI and TI suppliers consider certain information to be proprietary, and thus CAS numbers and other limited information may not be available for release.

In no event shall TI's liability arising out of such information exceed the total purchase price of the TI part(s) at issue in this document sold by TI to Customer on an annual basis.

TAPE AND REEL INFORMATION

QUADRANT ASSIGNMENTS FOR PIN 1 ORIENTATION IN TAPE

*All dimensions are nominal

Device	Package Type	Package Drawing	Pins	SPQ	Reel Diameter (mm)	Reel Width W1 (mm)	A0 (mm)	B0 (mm)	K0 (mm)	P1 (mm)	W (mm)	Pin1 Quadrant
DS90LV048ATMTCX	TSSOP	PW	16	2500	330.0	12.4	6.95	5.6	1.6	8.0	12.0	Q1
DS90LV048ATMTCX/NO PB	TSSOP	PW	16	2500	330.0	12.4	6.95	5.6	1.6	8.0	12.0	Q1
DS90LV048ATMX/NOPB	SOIC	D	16	2500	330.0	16.4	6.5	10.3	2.3	8.0	16.0	Q1

TAPE AND REEL BOX DIMENSIONS

*All dimensions are nominal

Device	Package Type	Package Drawing	Pins	SPQ	Length (mm)	Width (mm)	Height (mm)
DS90LV048ATMTCX	TSSOP	PW	16	2500	367.0	367.0	35.0
DS90LV048ATMTCX/NOPB	TSSOP	PW	16	2500	367.0	367.0	35.0
DS90LV048ATMX/NOPB	SOIC	D	16	2500	367.0	367.0	35.0

D (R-PDSO-G16)

PLASTIC SMALL OUTLINE



- NOTES:
- A. All linear dimensions are in inches (millimeters).
 - B. This drawing is subject to change without notice.
 - C. Body length does not include mold flash, protrusions, or gate burrs. Mold flash, protrusions, or gate burrs shall not exceed 0.006 (0,15) each side.
 - D. Body width does not include interlead flash. Interlead flash shall not exceed 0.017 (0,43) each side.
 - E. Reference JEDEC MS-012 variation AC.



4220204/A 02/2017

NOTES:

1. All linear dimensions are in millimeters. Any dimensions in parenthesis are for reference only. Dimensioning and tolerancing per ASME Y14.5M.
2. This drawing is subject to change without notice.
3. This dimension does not include mold flash, protrusions, or gate burrs. Mold flash, protrusions, or gate burrs shall not exceed 0.15 mm per side.
4. This dimension does not include interlead flash. Interlead flash shall not exceed 0.25 mm per side.
5. Reference JEDEC registration MO-153.

EXAMPLE BOARD LAYOUT

PW0016A

TSSOP - 1.2 mm max height

SMALL OUTLINE PACKAGE



LAND PATTERN EXAMPLE
EXPOSED METAL SHOWN
SCALE: 10X



4220204/A 02/2017

NOTES: (continued)

- 6. Publication IPC-7351 may have alternate designs.
- 7. Solder mask tolerances between and around signal pads can vary based on board fabrication site.

EXAMPLE STENCIL DESIGN

PW0016A

TSSOP - 1.2 mm max height

SMALL OUTLINE PACKAGE



SOLDER PASTE EXAMPLE
BASED ON 0.125 mm THICK STENCIL
SCALE: 10X

4220204/A 02/2017

NOTES: (continued)

8. Laser cutting apertures with trapezoidal walls and rounded corners may offer better paste release. IPC-7525 may have alternate design recommendations.
9. Board assembly site may have different recommendations for stencil design.

IMPORTANT NOTICE AND DISCLAIMER

TI PROVIDES TECHNICAL AND RELIABILITY DATA (INCLUDING DATASHEETS), DESIGN RESOURCES (INCLUDING REFERENCE DESIGNS), APPLICATION OR OTHER DESIGN ADVICE, WEB TOOLS, SAFETY INFORMATION, AND OTHER RESOURCES "AS IS" AND WITH ALL FAULTS, AND DISCLAIMS ALL WARRANTIES, EXPRESS AND IMPLIED, INCLUDING WITHOUT LIMITATION ANY IMPLIED WARRANTIES OF MERCHANTABILITY, FITNESS FOR A PARTICULAR PURPOSE OR NON-INFRINGEMENT OF THIRD PARTY INTELLECTUAL PROPERTY RIGHTS.

These resources are intended for skilled developers designing with TI products. You are solely responsible for (1) selecting the appropriate TI products for your application, (2) designing, validating and testing your application, and (3) ensuring your application meets applicable standards, and any other safety, security, or other requirements. These resources are subject to change without notice. TI grants you permission to use these resources only for development of an application that uses the TI products described in the resource. Other reproduction and display of these resources is prohibited. No license is granted to any other TI intellectual property right or to any third party intellectual property right. TI disclaims responsibility for, and you will fully indemnify TI and its representatives against, any claims, damages, costs, losses, and liabilities arising out of your use of these resources.

TI's products are provided subject to TI's Terms of Sale (www.ti.com/legal/termsofsale.html) or other applicable terms available either on ti.com or provided in conjunction with such TI products. TI's provision of these resources does not expand or otherwise alter TI's applicable warranties or warranty disclaimers for TI products.

Mailing Address: Texas Instruments, Post Office Box 655303, Dallas, Texas 75265
Copyright © 2018, Texas Instruments Incorporated

Looking for pricing, stock, or lifecycle information?

Click below to explore more details on WIN SOURCE:

 [View DS90LV048ATMTCX](#) on WIN SOURCE

 [Texas Instruments](#) Information

Optimize Your Supply Chain with WIN SOURCE Solutions

-  Global Sourcing Solution
-  Obsolete Management
-  Cost Control Management
-  Shortage Management
-  Alternative Solution
-  Excess Inventory Management