



**THE DATASHEET OF  
GT17HN-4DS-2C(B)**



Jun.1.2019 Copyright 2019 HIROSE ELECTRIC CO., LTD. All Rights Reserved.  
 In case of consideration for using Automotive equipment / device which demand high reliability, kindly contact our sales window correspondents.

ELV. RoHS COMPLIANT

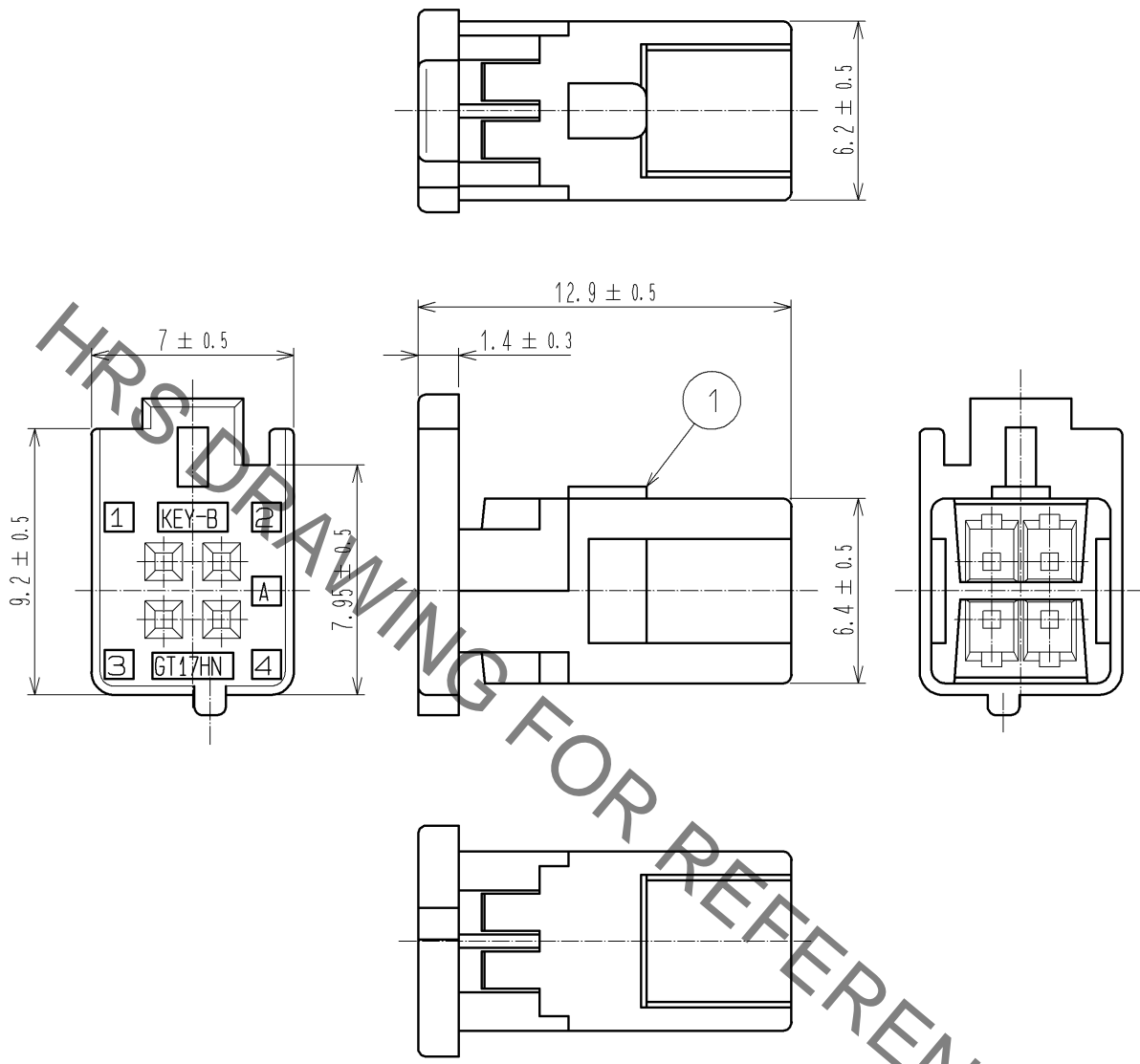

APPLICABLE CONTACT: GT8-2428SCF(70)

1	PBT	GREEN						
NO.	MATERIAL	FINISH	REMARKS	NO.	MATERIAL	FINISH	REMARKS	
UNITS mm		SCALE 4 : 1	COUNT 	DESCRIPTION OF REVISIONS		DESIGNED	CHECKED	DATE
HIROSE ELECTRIC CO., LTD.		APPROVED : AR. SHIRAI	09.05.20	DRAWING NO.		EDC4-166836-00		
		CHECKED : NH. NAKATA	09.05.19	PART NO.		GT17HN-4DS-2C(B)		
		DESIGNED : TS. KUBOTA	09.05.19	CODE NO.		CL767-0147-4-00		
		DRAWN : TS. KUBOTA	09.05.19			1/1		

# Mouser Electronics

Authorized Distributor



Click to View Pricing, Inventory, Delivery & Lifecycle Information:

[Hirose Electric:](#)







[GT17HN-4DS-2C\(B\)](#)

## Looking for pricing, stock, or lifecycle information?

Click below to explore more details on WIN SOURCE:

-  [View GT17HN-4DS-2C\(B\) on WIN SOURCE](#)
-  [Hirose Electric Co Ltd Information](#)

## Optimize Your Supply Chain with WIN SOURCE Solutions

-  Global Sourcing Solution
-  Obsolete Management
-  Cost Control Management
-  Shortage Management
-  Alternative Solution
-  Excess Inventory Management