



**THE DATASHEET OF
SPH8878LR5H-1**



ANALOG BOTTOM PORT SiSONIC™ MICROPHONE



The SPH8878LR5H-1 is a high-performance, bottom port analog silicon microphone, supporting both single-ended and differential modes. Using Knowles' proven high performance SiSonic™ MEMS technology, the SPH8878LR5H-1 consists of an acoustic sensor, a low noise input buffer, and an output amplifier. The microphone has a flat frequency response with low LFRO and phase distortion enabling superior noise cancelling algorithm performance. Its high, 67dB(A) SNR and 134 dB SPL AOP provides a large, distortion-free dynamic range for high-quality voice pickup.

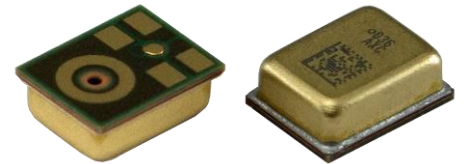
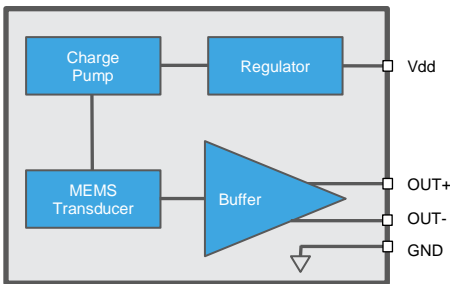

PRODUCT FEATURES

- Flat Frequency Response for ANC
- Low phase distortion
- High SNR and High AOP
- Bottom Port
- Ultra-Stable Performance
- Matched Sensitivity
- LGA Package
- Omnidirectional
- Standard SMD Reflow
- Wide Temperature Operating Range

TYPICAL APPLICATIONS

- Smart Speakers
- ANC Headsets
- Beam Forming Applications
- Proximity Detection

ABSOLUTE MAXIMUM RATINGS

Table 1: Absolute Maximum Ratings

Parameter	Absolute Maximum Rating	Units
Vdd to Ground	-0.5, +5.0	V
OUT+, OUT- to Ground	-0.3, Vdd+0.3	V
Input Current	±5	mA
Storage Temperature	-40 to +125	°C
Operating Temperature	-40 to +85	°C

Stresses exceeding these "Absolute Maximum Ratings" may cause permanent damage to the device. These are stress ratings only. Functional operation at these or any other conditions beyond those indicated under "Acoustic & Electrical Specifications" is not implied. Exposure beyond those indicated under "Acoustic & Electrical Specifications" for extended periods may affect device reliability.



ACOUSTIC & ELECTRICAL SPECIFICATIONS¹

Table 2: Normal Mode Microphone Specifications

Test Conditions: 23 ±2°C, 55±20% R.H., Vdd=2.75V, no load, unless otherwise indicated

Parameter	Symbol	Conditions	Min	Typ	Max	Units
Supply Voltage	Vdd		2.3	2.75	3.6	V
Supply Current	Idd	Vdd = 3.6 V	-	265	-	µA
		Vdd = 2.75 V	-	250	-	
Sensitivity	S	94 dB SPL @ 1kHz, Single-Ended	-45	-44	-43	dBV/Pa
		94 dB SPL @ 1kHz, Differential	-39	-38	-37	
Signal to Noise Ratio	SNR	94 dB SPL @ 1kHz, A-weighted, Single-Ended Mode	-	67	-	dBV/Pa
		94 dB SPL @ 1kHz, A-weighted, Differential Mode	-	67	-	
Near-Ultrasonic SNR		94 dB SPL, @ 19 kHz, BW = 18.5 - 20.0 kHz, SE	-	79	-	dB
		94 dB SPL, @ 19 kHz, BW = 18.5 - 20.0 kHz, D	-	79	-	
Total Harmonic Distortion	THD	94 dB SPL @ 1 kHz	-	0.05	-	%
		115 dB SPL @ 1 kHz	-	0.4	-	%
		1% THD @ 1 kHz, S = typ	-	124	-	dB SPL
Acoustic Overload Point	AOP	10% THD @ 1 kHz, S = typ	-	134	-	dB SPL
Low Frequency Rolloff	LFRO	-3dB relative to 1 kHz	-	7	-	Hz
High Frequency Flatness		+3dB relative to 1 kHz	-	19	-	kHz
Resonant Frequency Peak	Fres		-	36	-	kHz
Power Supply Rejection Ratio	PSRR	200 mVpp sinewave @ 1 kHz, Single-Ended Mode	-	86	-	dB
		200 mVpp sinewave @ 1 kHz, Differential Mode	-	85	-	
Power Supply Rejection	PSR+N	200 mVpp 7/8 duty cycle rectangular waveform @ 217 Hz, A-weighted, BW = 20 kHz, SE	-	-103	-	dBV(A)
		200 mVpp 7/8 duty cycle rectangular waveform @ 217 Hz, A-weighted, BW = 20 kHz, Differential	-	-103	-	
DC Output		Vdd = 2.75V	-	0.69	-	V
DC Offset		OUT+ to OUT-	-	-	±20	mV
Output Impedance	Zout	@ 1 kHz	-	380	-	Ω
Output Load	Cload		-	-	-	pF
	Rload	AC-coupled	10	-	-	kΩ
Sensitivity Drop		Vdd(min) ≤ Vdd ≤ Vdd(max)	-	-	±0.25	dB
Directivity			Omnidirectional			
Polarity		Increasing sound pressure	Increasing Output Voltage			
Startup Time		S within 1 dB of final value, outputs AC coupled	-	-	15	ms



Table 3: Low-Power Mode Microphone Specifications

Test Conditions: 23 ±2°C, 55±20% R.H., Vdd=1.8V, no load, unless otherwise indicated

Parameter	Symbol	Conditions	Min	Typ	Max	Units
Supply Voltage	Vdd		1.6	1.8	1.9	V
Supply Current	Idd	Vdd = 1.8 V	-	100	-	µA
		Vdd = 1.6 V	-	95	-	
Sensitivity	S	94 dB SPL @ 1kHz, Single-Ended	-45	-44	-43	dBV/Pa
		94 dB SPL @ 1kHz, Differential	-39	-38	-37	
Signal to Noise Ratio	SNR	94 dB SPL @ 1kHz, A-weighted, Single-Ended Mode	-	66	-	dBV/Pa
		94 dB SPL @ 1kHz, A-weighted, Differential Mode	-	64.5	-	
Near-Ultrasonic SNR		94 dB SPL, @ 19 kHz, BW = 18.5 - 20.0 kHz, SE	-	78	-	dB
		94 dB SPL, @ 19 kHz, BW = 18.5 - 20.0 kHz, D	-	76.5	-	
Total Harmonic Distortion	THD	94 dB SPL @ 1 kHz	-	0.05	-	%
		115 dB SPL @ 1 kHz	-	0.4	-	%
		1% THD @ 1 kHz, S = typ	-	125	-	dB SPL
Acoustic Overload Point	AOP	10% THD @ 1 kHz, S = typ	-	131.5	-	dB SPL
Low Frequency Rolloff	LFRO	-3dB relative to 1 kHz	-	7	-	Hz
High Frequency Flatness		+3dB relative to 1 kHz	-	19	-	kHz
Resonant Frequency Peak	Fres		-	36	-	kHz
Power Supply Rejection Ratio	PSRR	200 mVpp sinewave @ 1 kHz, Single-Ended Mode	-	73	-	dB
		200 mVpp sinewave @ 1 kHz, Differential Mode	-	73	-	
Power Supply Rejection	PSR+N	200 mVpp 7/8 duty cycle rectangular waveform @ 217 Hz, A-weighted, BW = 20 kHz, SE	-	-97	-	dBV(A)
		200 mVpp 7/8 duty cycle rectangular waveform @ 217 Hz, A-weighted, BW = 20 kHz, Differential	-	-96	-	
DC Output		Vdd = 1.8V	-	0.69	-	V
DC Offset		OUT+ to OUT-	-	-	±20	mV
Output Impedance	Zout	@ 1 kHz	-	-	380	Ω
Output Load	Cload		-	-	-	pF
	Rload	AC-coupled	10	-	-	kΩ
Sensitivity Drop		Vdd(min) ≤ Vdd ≤ Vdd(max)	-	-	±0.25	dB
Directivity			Omnidirectional			
Polarity		Increasing sound pressure	Increasing Output Voltage			
Startup Time		S within 1 dB of final value, outputs AC coupled	-	-	15	ms

¹ Sensitivity and Supply Current are 100% tested.



Figure 1: Typical Single-Ended Application Circuit

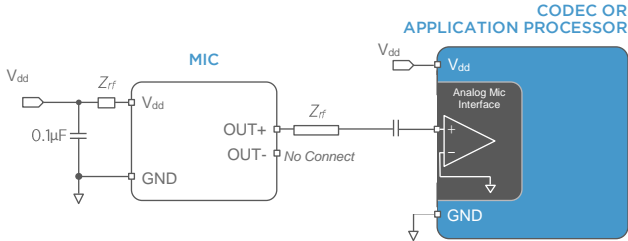

NOTES:

All Ground pins must be connected to ground.
 If necessary to improve RF performance, optional series components (resistors, ferrites, etc.) should be placed closest to the microphone pads.
 Capacitors near the microphone should not contain Class 2 dielectrics due to their piezoelectric effect.
 Bypass capacitors should be placed next to each Vdd pin for best performance. Follow the codec manufacturer's recommendations for circuitry and layout.

PERFORMANCE CURVES

Test Conditions: 23 ±2°C, 55±20% R.H., Vdd=2.75V (NM) / 1.8V (LPM), no load, unless otherwise indicated

Figure 3: Typical Free Field Magnitude Response and Masks

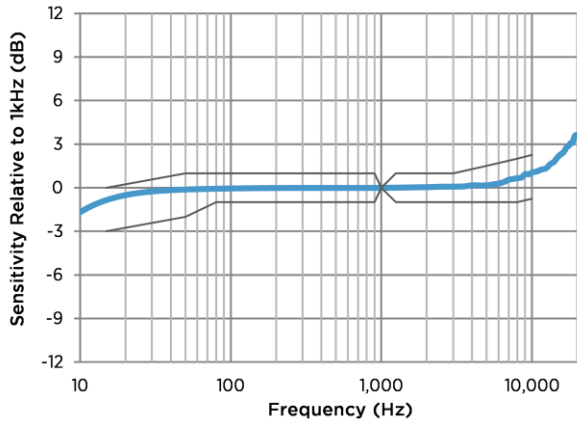

	15	50	80	900	1000	1250	3000	5000	8000	10000
USL	0	1	1	1	0	1	1	1.5	2	2.25
LSL	-3	-2	-1	-1	0	-1	-1	-1	-1	-0.75

Figure 4: Typical THD vs Input SPL

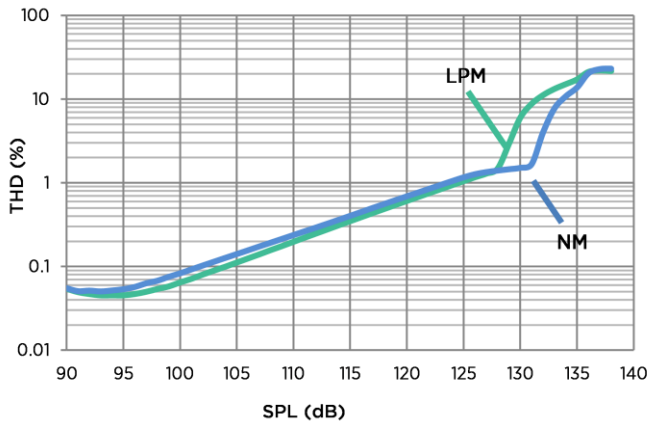

Figure 2: Typical Differential Mode Application Circuit

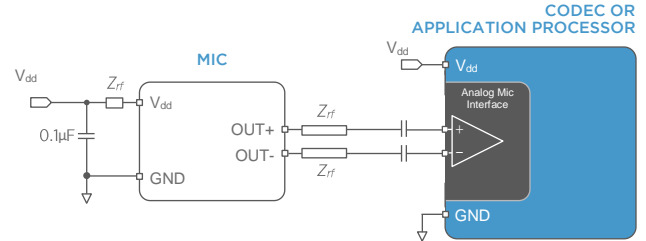

Figure 5: Typical Phase Response and Group Delay

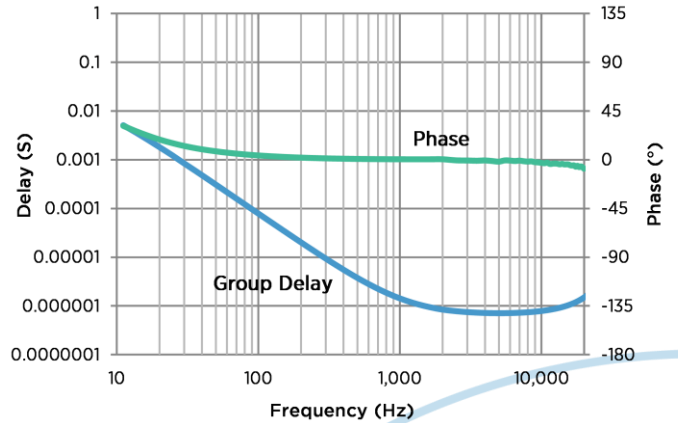

Figure 6: Typical THD vs Input Frequency

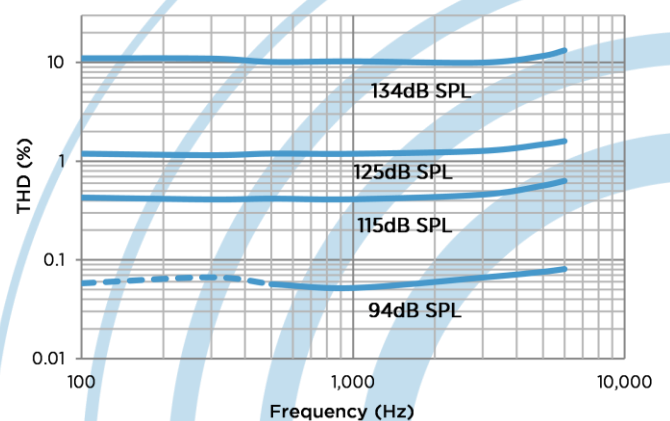

Figure 7: Typical Free Field Ultrasonic Response

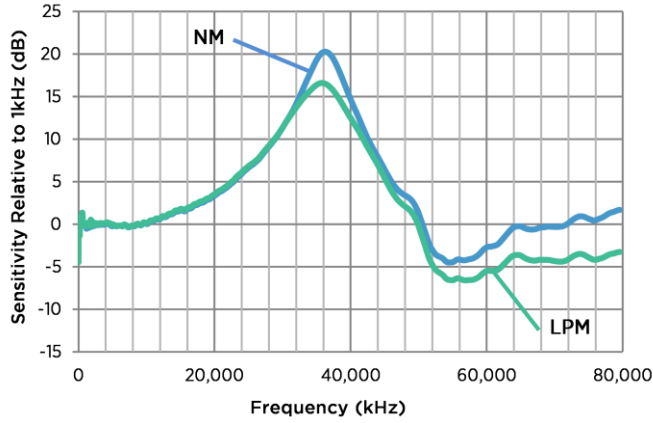

Figure 10: Typical I_{dd} vs V_{dd}

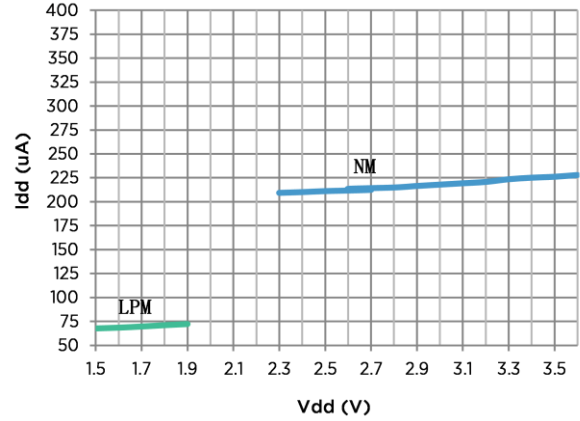

Figure 8: Noise Floor Power Spectral Density (LPM)

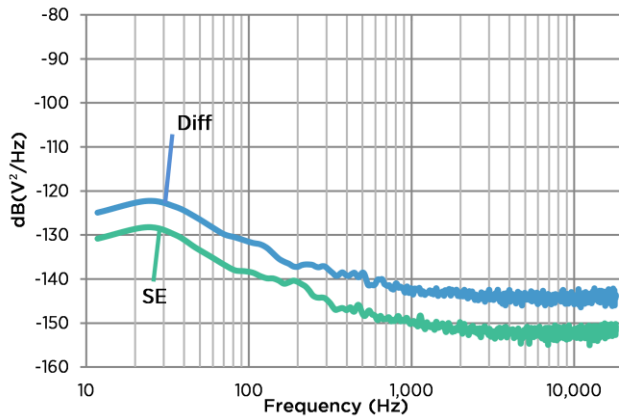

Figure 11: Noise Floor Power Spectral Density (NM)

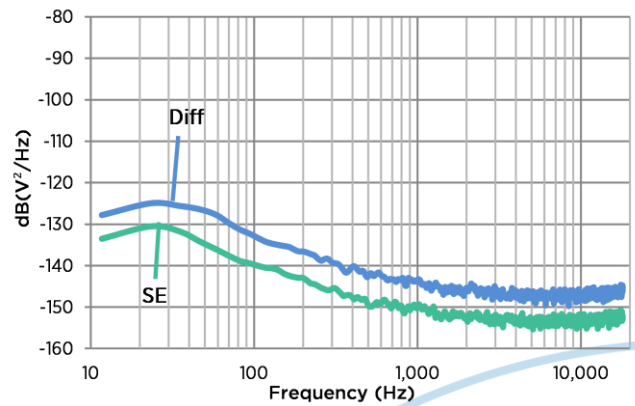

Figure 9: Typical PSRR (LPM)

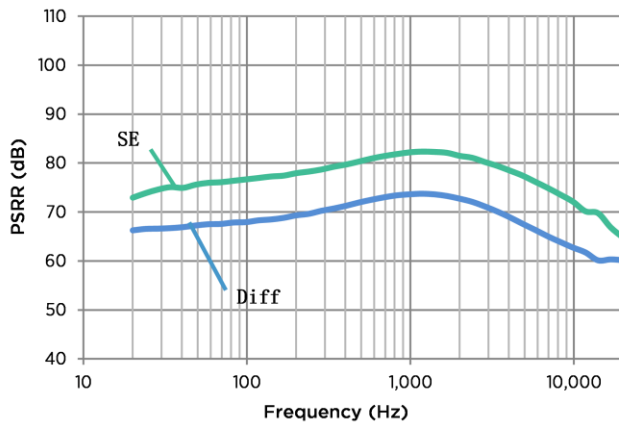
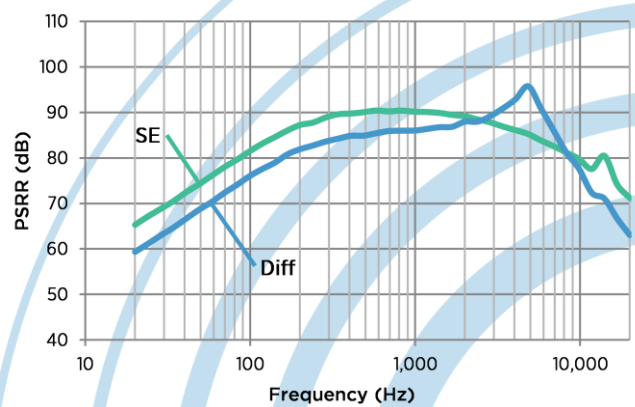
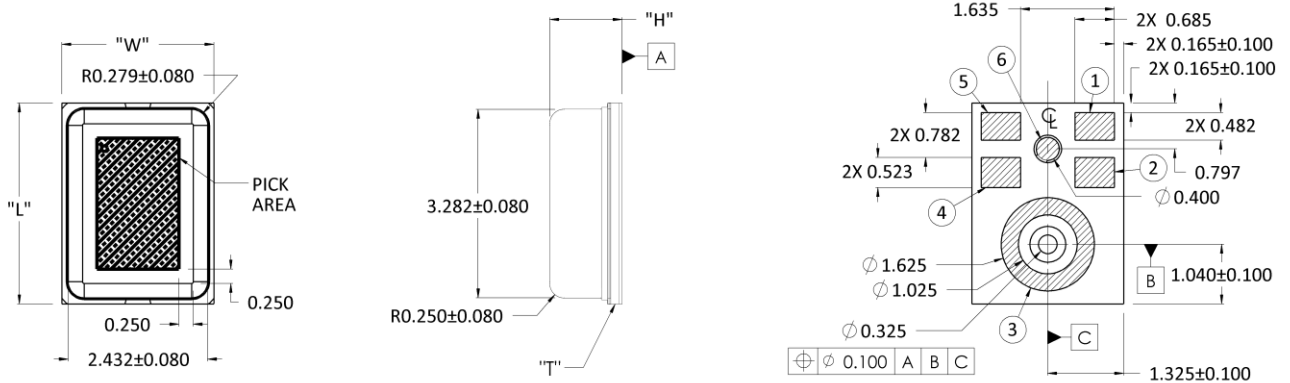

Figure 12: Typical PSRR (NM)



MECHANICAL SPECIFICATIONS



Item	Dimension	Tolerance
Length (L)	3.50	±0.10
Width (W)	2.65	±0.10
Height (H)	1.26	±0.10
Acoustic Port (AP)	Ø0.325	±0.05
PCB Thickness (T)	0.25	±0.05

Pin #	Pin Name	Type	Description
1	OUT (+)	Signal	Output
2	GROUND	Power	Ground
3	GROUND	Power	Ground
4	GROUND	Power	Ground
5	Vdd	Power	Power Supply
6	OUT (-)	Signal	Output

Example Land Pattern

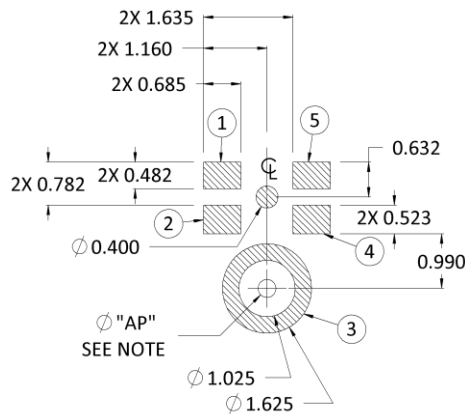

Example Solder Stencil Pattern

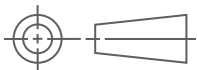
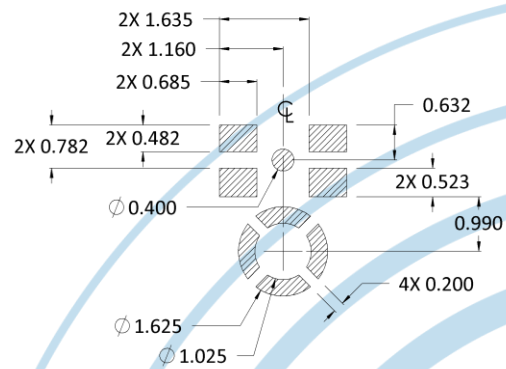

Pick Area only extends to 0.25 mm of any edge or hole unless otherwise specified.
Dimensions are in millimeters unless otherwise specified.
Tolerance is ±0.15mm unless otherwise specified.

In the acoustic path, the recommended PCB Hole Diameter is $0.6 \leq D \leq 1.0$ mm, the recommended Gasket Cavity Diameter is $D \geq 1.0$ mm and the recommended Case Hole Diameter is $1.0 \leq D \leq 1.5$ mm. Further optimizations based on application should be performed.



RECOMMENDED REFLOW PROFILE

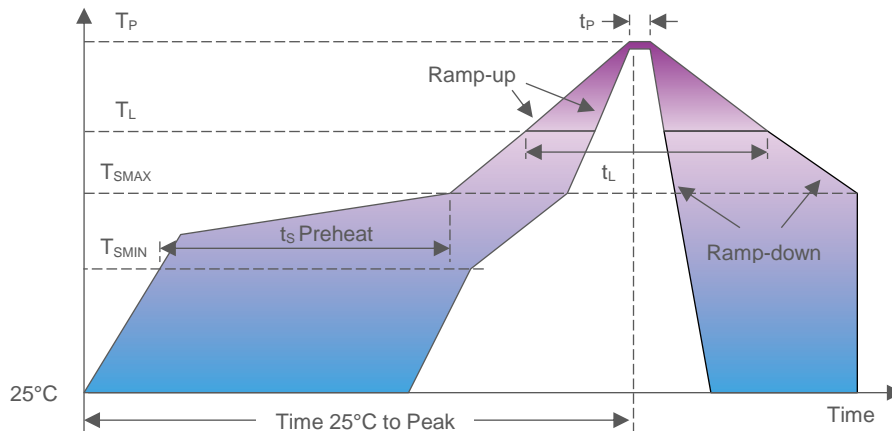

Profile Feature	Pb-Free
Average Ramp-up rate ($T_{S_{MAX}}$ to T_P)	3°C/second max.
Preheat <ul style="list-style-type: none"> • Temperature Min ($T_{S_{MIN}}$) • Temperature Max ($T_{S_{MAX}}$) • Time ($T_{S_{MIN}}$ to $T_{S_{MAX}}$) (t_s) 	150°C 200°C 60-180 seconds
Time maintained above: <ul style="list-style-type: none"> • Temperature (T_L) • Time (t_L) 	217°C 60-150 seconds
Peak Temperature (T_P)	260°C
Time within 5°C of actual Peak Temperature (t_p)	20-40 seconds
Ramp-down rate (T_P to $T_{S_{MAX}}$)	6°C/second max
Time 25°C to Peak Temperature	8 minutes max

NOTES:

Based on IPC/JEDEC J-STD-020 Revision C.

All temperatures refer to topside of the package, measured on the package body surface.

The actual reflow profile used should be optimized based on the reflow requirements of all components, board design, solder paste formulation and reflow equipment used. Details of recommended handling and manufacturing processes can be found in AN25 SMT Manufacturing Guidelines for SiSonic™ Microphones.

ADDITIONAL NOTES

- MSL (moisture sensitivity level) Class 1.
- Maximum of 3 reflow cycles is recommended.
- In order to minimize device damage:
 - Do not board wash or clean after the reflow process.
 - Do not brush board with or without solvents after the reflow process.
 - Do not directly expose to ultrasonic processing, welding, or cleaning.
 - Do not insert any object in port hole of device at any time.
 - Do not apply over 30 psi of air pressure into the port hole.
 - Do not pull a vacuum over port hole of the microphone.
 - Do not apply a vacuum when repacking into sealed bags at a rate faster than 0.5 atm/sec.
 - Do not directly expose to vapor phase soldering.



MATERIALS STATEMENT

Meets the requirements of the European RoHS directive 2011/65/EC as amended.

Meets the requirements of the industry standard IEC 61249-2-21:2003 for halogenated substances and Knowles Green Materials Standards Policy section on Halogen-Free.

Product is Beryllium Free according to limits specified on the Knowles Hazardous Material List (HSL for Products).

Ozone depleting substances are not used in the product or the processes used to make the product, including compounds listed in Annex A, B, and C of the "Montreal Protocol on Substances That Deplete the Ozone Layer."

RELIABILITY SPECIFICATIONS

Test	Description
Thermal Shock	100 cycles of air-air thermal shock from -40°C to +125°C with 15 minute soaks (IEC 68-2-14)
High Temperature Storage	+105°C, 1,000 hours per JESD22-A103 (See Notes)
Low Temperature Storage	-40°C, 1,000 hours per JESD22-A119 (See Notes)
High Temperature Bias	+140°C, 168 hours (equivalent to +105°C, 1,000 hours per JESD22-A108)
Low Temperature Bias	-55°C, 168 hours (equivalent to -40°C, 1,000 hours per JESD22-A108)
Temperature/Humidity Bias	+85°C/85% R.H., 1,000 hours (JESD22-A101A-B)
Vibration	16 minutes in each X, Y, Z axis from 20 to 2,000 Hz with peak acceleration of 20g (MIL STD-883e, Method 2007.2, Condition A)
ESD-HBM	3 discharges at ±2kV direct contact to I/O pins (ANSI/ESDA/JEDEC JS-001-2014)
ESD-HMM	10 discharges at ±8kV direct contact to lid when unit is grounded (ANSI/ESD SP5.6-2009)
ESD-CDM	3 discharges at ±500V (ANSI/ESDA/JEDEC JS-002-2014)
Reflow	5 reflow cycles with peak temperature of +260°C (JEDEC 22-A113F)
Mechanical Shock	3 pulses of 12,000g in each of the X, Y, and Z directions (IEC 68-2-27 Test Ea)

NOTES:

Microphones meet all acoustic and electrical specifications before and after reliability testing, except sensitivity which can deviate up to 3dB.

After 3 reflow cycles, the sensitivity of the microphones shall not deviate more than 1 dB from its initial value.

Temperature Storage testing is covered by Temperature Bias testing as $T_a = T_j$ for Knowles Microphones.

Mouser Electronics

Authorized Distributor

Click to View Pricing, Inventory, Delivery & Lifecycle Information:

[Knowles:](#)

[SPH8878LR5H-1](#)

Looking for pricing, stock, or lifecycle information?

Click below to explore more details on WIN SOURCE:

 [View SPH8878LR5H-1 on WIN SOURCE](#)

 [Knowles](#) Information

Optimize Your Supply Chain with WIN SOURCE Solutions

-  Global Sourcing Solution
-  Obsolete Management
-  Cost Control Management
-  Shortage Management
-  Alternative Solution
-  Excess Inventory Management