



**THE DATASHEET OF
8Z-12.000MAHQ-T**



Features

Frequency range : 12MHz to 66MHz
 Ceramic SMD package
 Seam sealing
 External dimensions (mm)
 L : 2.5 x W : 2.0 x H : 0.55
 RoHS compliant & Pb free

Applications

Bluetooth, Wireless LAN
 Microprocessor
 Mobile phone, Computer, Modem
 Audio, Video
 Consumer products

Electrical Characteristics

Item		8Z	Conditions
Frequency Range	F_0	12MHz ~ 66MHz	
Frequency Tolerance	F_{tol}	±30ppm, ±20ppm, ±10ppm	at 25°C
Frequency Stability over Operating Temperature Range (refer to 25°C)	F_{stab}	±30 ppm	-20°C ~ +70°C
		±20 ppm	
		±10 ppm	-30°C ~ +85°C
		±10 ppm	
		±30 ppm	-40°C ~ +85°C
		±20 ppm	
±60 ppm	-40°C ~ +125°C		
Operating Temperature Range	T_{OTR}	-20°C ~ +70°C	
		-40°C ~ +85°C	
		-40°C ~ +125°C	
Shunt Capacitance	C_0	3pF Max.	
Drive Level	D_L	1 ~ 200μW (100μW Typ.)	
Load Capacitance	C_L	6pF, 8pF, 10pF 12pF, 16pF, 18pF, 20pF	
Aging (at 25°C ± 3°C, first year)	F_{aging}	±3ppm Max.	Note [1]
Storage Temperature Range	T_{STR}	-55°C ~ +125°C	

Notes:

[1] Please contact us for low aging +/-1ppm grade crystals.

Motional Resistance (ESR)

Fundamental	
12 ~ 13 MHz	150Ω Max.
14 ~ 30 MHz	100Ω Max.
30 ~ 66 MHz	60Ω Max.

Dimensions

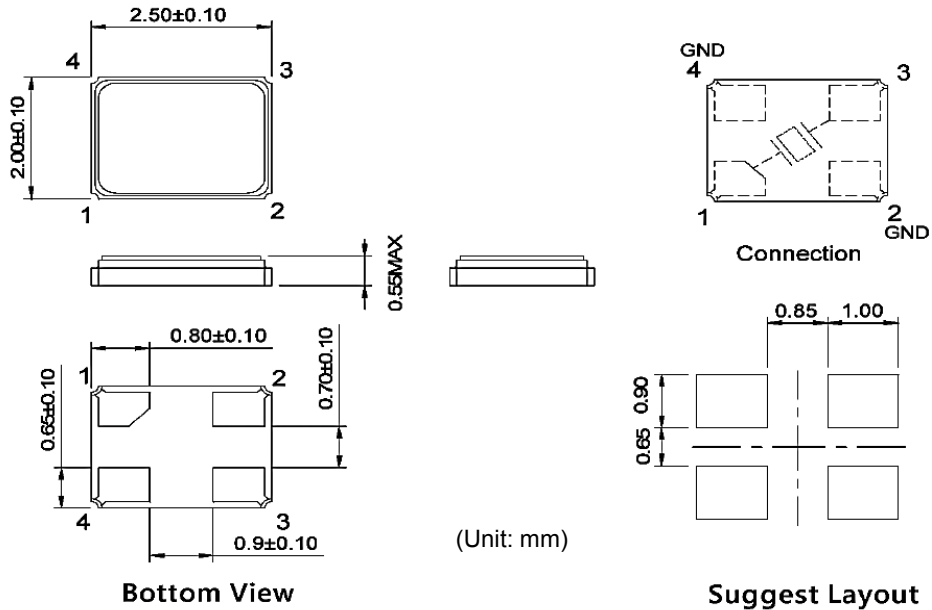

Ordering Information

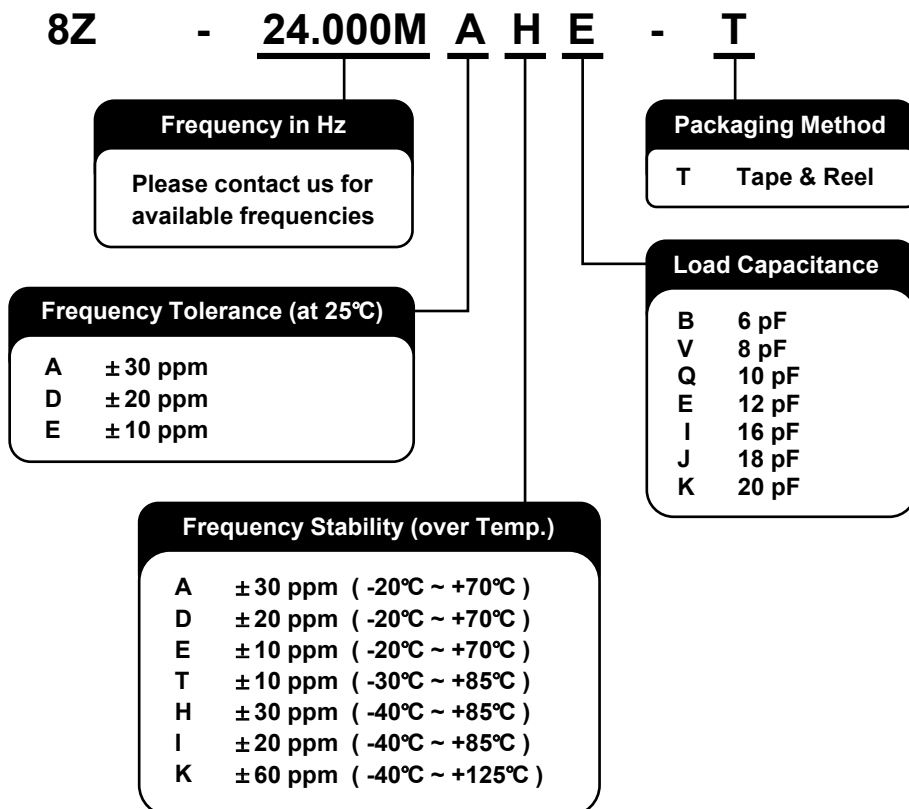

Packing

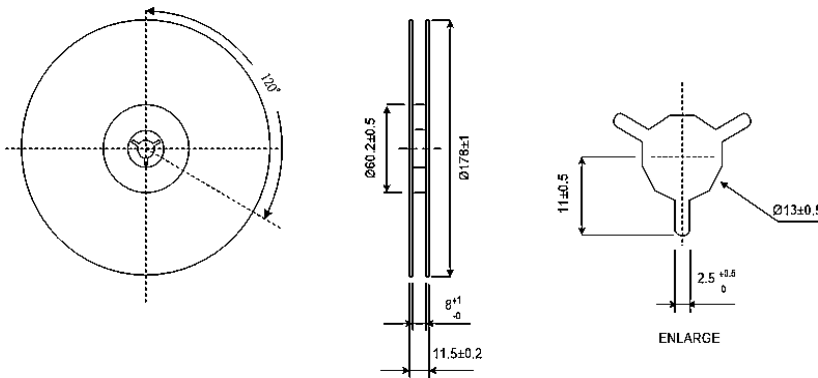
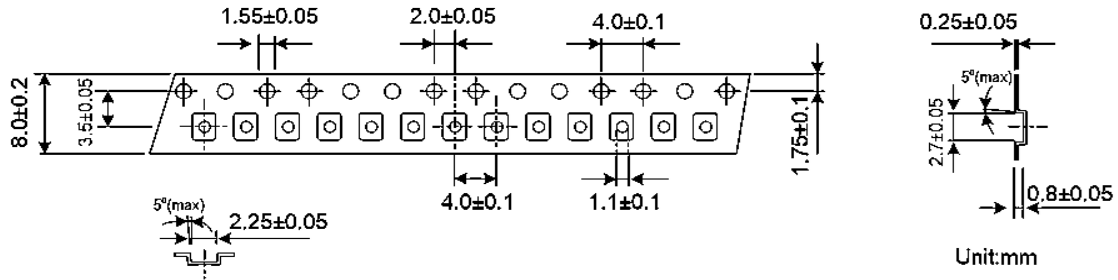

(Unit: mm)

Reflow Profile

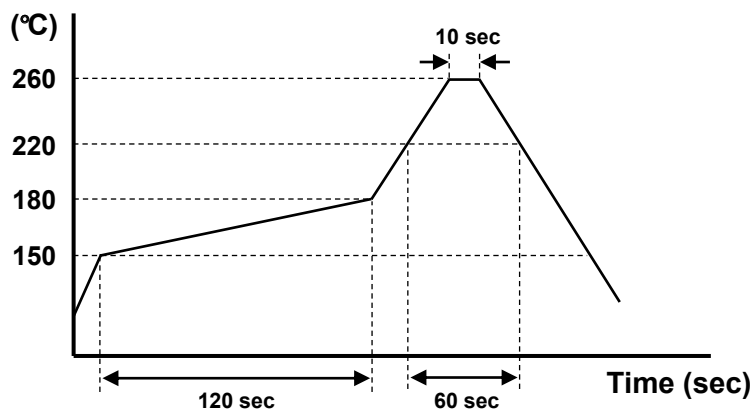

Solder melting point : 220°C ± 10°C, 60 sec. Min.

Peak temperature : 260°C ± 10°C, 10 sec. Min.



Looking for pricing, stock, or lifecycle information?

Click below to explore more details on WIN SOURCE:

-  [View 8Z-12.000MAHQ-T on WIN SOURCE](#)
-  [TXC CORPORATION](#) Information

Optimize Your Supply Chain with WIN SOURCE Solutions

-  Global Sourcing Solution
-  Obsolete Management
-  Cost Control Management
-  Shortage Management
-  Alternative Solution
-  Excess Inventory Management