



**THE DATASHEET OF
1413000000**



OMNIMATE Signal - series RSV RSV1,6 B4 GR

Weidmüller Interface GmbH & Co. KG
Klingenbergstraße 16
D-32758 Detmold
Germany
Fon: +49 5231 14-0
Fax: +49 5231 14-292083
www.weidmueller.com



Rectangular plug-in connector for use with crimp contacts. Can be used as universal coupling, but also with the PCB variations. The crimp contacts guarantee a high connection density. CS 1.6 or CB 1.6 contacts can be used here. The plug-in connectors can be coded and locked to the mating connector. Supplied in cardboard box.

General ordering data

Type	RSV1,6 B4 GR
Order No.	1413000000
Version	PCB plug-in connector, female plug, 5.00 mm, No. of poles: 4, 180°, Crimp connection, Clamping range, max. : 3.31 mm ² , Box
GTIN (EAN)	4008190076320
Qty.	25 pc(s).
Product data	IEC: 630 V / 17 A UL: 600 V / 10 A / AWG 26 - AWG 12
Packaging	Box

**OMNIMATE Signal - series RSV
RSV1,6 B4 GR**

Weidmüller Interface GmbH & Co. KG
 Klingenbergstraße 16
 D-32758 Detmold
 Germany
 Fon: +49 5231 14-0
 Fax: +49 5231 14-292083
 www.weidmueller.com

Technical data**Dimensions and weights**

Net weight	5.24 g
------------	--------

System parameters

Product family	OMNIMATE Signal - series RSV	Type of connection	Field connection
Wire connection method	Crimp connection	Pitch in mm (P)	5 mm
Pitch in inches (P)	0.197 inch	Conductor outlet direction	180°
No. of poles	4	L1 in mm	5 mm
L1 in inches	0.197 inch	Number of rows	1
Pin series quantity	2	Touch-safe protection acc. to DIN VDE 57 106	Safe from finger touch
Touch-safe protection acc. to DIN VDE 0470	IP 20	Can be coded	Yes
Stripping length	4 mm	push-in force/pole	9 N
Withdrawal force per pole	18 N	Packaging	Box

Material data

Insulating material	Wemid (PA)	Colour	Pebble grey
Colour chart (similar)	RAL 7032	Insulating material group	I
CTI	≥ 600	UL 94 flammability rating	V-0
Contact material	Copper alloy	Storage temperature, min.	-25 °C
Storage temperature, max.	55 °C	Max. relative humidity during storage	80 %
Operating temperature, max.	100 °C	Temperature range, installation, max.	100 °C

Conductors suitable for connection

Clamping range, min.	0.13 mm ²	Clamping range, max.	3.31 mm ²
Flexible, min. H05(07) V-K	0.2 mm ²	Flexible, max. H05(07) V-K	2.5 mm ²

Rated data acc. to IEC

tested acc. to standard	IEC 60664-1, IEC 61984	Rated current, min. no. of poles (Tu=20°C)	17 A
Rated current, max. no. of poles (Tu=20°C)	13 A	Rated current, min. no. of poles (Tu=40°C)	15 A
Rated current, max. no. of poles (Tu=40°C)	11.5 A	Rated voltage for surge voltage class / pollution degree II/2	630 V
Rated voltage for surge voltage class / pollution degree III/2	400 V	Rated voltage for surge voltage class / pollution degree III/3	250 V
Rated impulse voltage for surge voltage class/ pollution degree II/2	4 kV	Rated impulse voltage for surge voltage class/ pollution degree III/2	4 kV
Rated impulse voltage for surge voltage class/ contamination degree III/3	4 kV	Short-time withstand current resistance	3 x 1s with 120 A

Data sheet

**OMNIMATE Signal - series RSV
RSV1,6 B4 GR**

Weidmüller Interface GmbH & Co. KG
Klingenbergstraße 16
D-32758 Detmold
Germany
Fon: +49 5231 14-0
Fax: +49 5231 14-292083
www.weidmueller.com

Technical data

Rated data acc. to CSA

Institute (CSA)		Certificate No. (CSA)	53975-13
Rated voltage (Use group C)	600 V	Rated current (use group C)	13 A
Wire cross-section, AWG, min.	AWG 26	Wire cross-section, AWG, max.	AWG 12
Reference to approval values	Specifications are maximum values, details - see approval certificate.		

Rated data acc. to UL 1059

Institute (UR)		Certificate No. (UR)	E92202
Reference to approval values	Specifications are maximum values, details - see approval certificate.		

Classifications

ETIM 3.0	EC001284	ETIM 4.0	EC002636
ETIM 5.0	EC002636	ETIM 6.0	EC002637
UNSPSC	30-21-18-10	eClass 5.1	27-26-07-01
eClass 6.2	27-26-07-03	eClass 7.1	27-44-01-01
eClass 8.1	27-44-01-01	eClass 9.0	27-44-01-01
eClass 9.1	27-44-04-02		

Notes

- Notes
- Additional colours on request
 - Rated current related to rated cross-section & min. No. of poles.
 - Spacing between rows: see hole layout
 - Rated cross-section depends on crimp contact used.
 - Rated data refer only to the component itself. Clearance and creepage distances to other components are to be designed in accordance with the relevant application standards.
 - Max. outer diameter of the cable (with insulation): 3.5 mm

IPC conformity The products are developed, manufactured and delivered according to the internationally recognised IPC-A-610 standard, category "permissible". More extensive demands on the products can be evaluated on request.

Approvals



ROHS Conform

Data sheet**OMNIMATE Signal - series RSV
RSV1,6 B4 GR**

Weidmüller Interface GmbH & Co. KG
Klingenbergstraße 16
D-32758 Detmold
Germany
Fon: +49 5231 14-0
Fax: +49 5231 14-292083
www.weidmueller.com

Technical data**Downloads**

Approval/Certificate/Document of Conformity	Declaration of the Manufacturer
Brochure/Catalogue	MB DEVICE MANUF. EN CAT 2 PORTEFOLIOGUIDE EN FL 72H SAMPLE SER EN PO OMNIMATE EN
Engineering Data	RSV1.6.zip

**OMNIMATE Signal - series RSV
RSV1,6 B4 GR**

Weidmüller Interface GmbH & Co. KG
Klingenbergstraße 16
D-32758 Detmold
Germany
Fon: +49 5231 14-0
Fax: +49 5231 14-292083
www.weidmueller.com

Drawings

Dimensional drawing

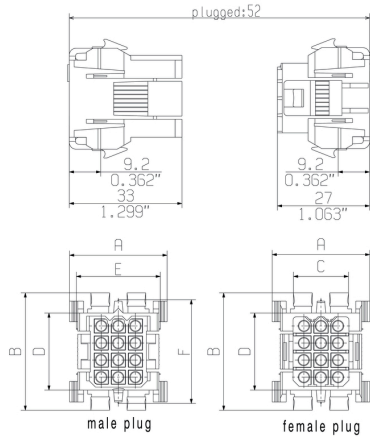

Dimensional drawing

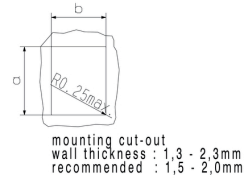

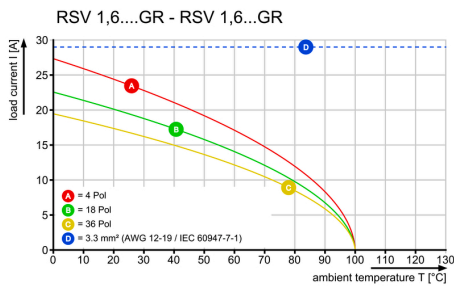

poles	dimension male plug / female plug					mounting cut-out	
	A	B	C	D	E	a ±0,2	b ±0,2
4	23,0	25,0	10,8	12,8	17,8	20,3	18,1
6	23,0	30,0	10,8	17,6	17,8	25,1	18,1
9	29,0	30,0	16,6	17,6	23,8	25,1	24,0
12	29,0	35,0	16,6	22,6	23,8	30,0	24,0
18	29,0	46,0	16,6	23,0	23,8	40,5	24,0
24	31,0	46,0	20,6	23,0	27,8	40,5	26,3
36	33,0	61,0	20,6	48,0	27,8	55,5	26,3

Graph



Looking for pricing, stock, or lifecycle information?

Click below to explore more details on WIN SOURCE:

-  [View 1413000000 on WIN SOURCE](#)
-  [Weidmuller Information](#)

Optimize Your Supply Chain with WIN SOURCE Solutions

-  Global Sourcing Solution
-  Obsolete Management
-  Cost Control Management
-  Shortage Management
-  Alternative Solution
-  Excess Inventory Management