



**THE DATASHEET OF  
1278230000**



### Preliminary product data

#### S2C-SMT 3.50/././90

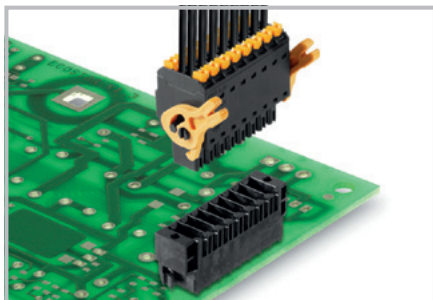

High-temperature-resistant male header for side-by-side mounting.

- Touch-safe
- Pluggable to the female plug B2CF 3.50 PUSH IN
- Plugging direction parallel to PCB (recumbent)
- Housing variants: closed (G) and with solder flange (LF).
- Packed in a carton (BX)
- 3.2-mm pin length suitable for reflow and wave soldering.

#### Product data

IEC: 200 V / 10 A  
UL: 150 V / 10 A

For additional articles and information, refer to [catalog.weidmueller.com](http://catalog.weidmueller.com)

#### Note:

- Gold-plated contact surface on request
- Tape packaged on request
- See hole pattern for distance between rows
- Rated voltage referenced to rated cross-section and minimum poles
- P on drg. = pitch
- Rated data relate to the respective component. Clearance and creepage distances to other components must be set in accordance with the relevant application standard.

#### S2C-SMT 3.50/././90G Box

##### Closed side



#### Dimensioned drawing

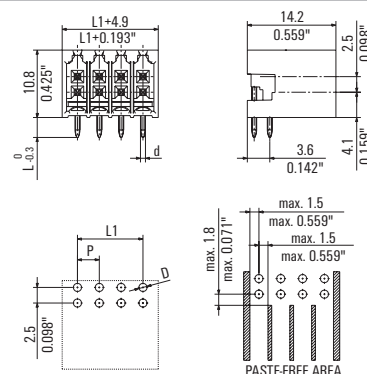



#### Technical data

In compliance with IEC 60664-1 / IEC 61984			
Clamping range, max.	mm <sup>2</sup>		
<b>Solid core H05(07) V-U</b>	<b>mm<sup>2</sup></b>		
Stranded H07 V-R			
Flexible H05(07) V-K	mm <sup>2</sup>		
Flexible with ferrule	mm <sup>2</sup>		
Ferrule with plastic collar	mm <sup>2</sup>		
Stripping length	mm		
Screwdriver blade	mm		
According to norm			
Tightening torque range	Nm		
<b>Rated current, max.</b>	<b>A</b>	<b>10</b>	<b>9</b>
At ambient temperature		20°C	40°C
For conductor cross-section	mm <sup>2</sup>	1,5	
Overtoltage category		III	II
Pollution severity		3	2
<b>Rated voltage</b>	<b>V</b>	<b>80</b>	<b>160</b>
Rated impulse voltage	kV	2,5	2,5
<b>UL / CUL (Use Group)</b>		<b>B</b>	<b>C</b>
<b>Rated voltage</b>	<b>V</b>	<b>150</b>	<b>50</b>
<b>Rated current</b>	<b>A</b>	<b>10</b>	<b>10</b>
<b>AWG conductor</b>	<b>AWG</b>		-
<b>CSA (Use Group)</b>		<b>B</b>	<b>C</b>
Rated voltage	V	150	
Rated current	A	10	
AWG conductor	AWG		-
<b>General data</b>			
Type of insulation material		LCP GF	
Flammability class UL 94		V-0	
Contact base material		Copper alloy	
Material of contact surface		tinned	
Pin dimensions = d	mm	1,0, Octagonal	
Solder eyelet Ø = D	mm	1,3	
Solder eyelet Ø tolerance	mm	+ 0,1	

#### Accessories

Note: Refer to the Accessories chapter for additional accessories.

Coding		Order No.
	B2L/S2L 3.5 KO OR	<b>1849730000</b>
	B2L/S2L 3.5 KO SW	<b>1849740000</b>
	S2L-SMT 3.5 FLA 20/10	<b>1814590000</b>

#### Ordering data

Solder pin length		1,5 mm	3,2 mm		
Colour		black	black		
<b>Pitch 3,50 mm</b>					
Pol.	L1 (inch)	Qty.	Order No.		
4	3,50	0,138	50	<b>1289630000</b>	<b>1289880000</b>
6	7,00	0,276	50	<b>1289640000</b>	<b>1289270000</b>
8	10,50	0,413	50	<b>1289650000</b>	<b>1289280000</b>
10	14,00	0,551	50	<b>1289670000</b>	<b>1289290000</b>
12	17,50	0,689	50	<b>1289680000</b>	<b>1289300000</b>
14	21,00	0,827	50	<b>1289700000</b>	<b>1289310000</b>
16	24,50	0,965	50	<b>1289710000</b>	<b>1289320000</b>
18	28,00	1,102	20	<b>1289720000</b>	<b>1289330000</b>
20	31,50	1,240	20	<b>1289730000</b>	<b>1289340000</b>
22	35,00	1,378	20	<b>1289740000</b>	<b>1289350000</b>
24	38,50	1,516	20	<b>1289750000</b>	<b>1289370000</b>
26	42,00	1,654	20	<b>1289770000</b>	<b>1289380000</b>
28	45,50	1,791	20	<b>1289780000</b>	<b>1289390000</b>
30	49,00	1,929	20	<b>1289790000</b>	<b>1289410000</b>
32	52,50	2,067	20	<b>1289800000</b>	<b>1289420000</b>
34	56,00	2,205	20	<b>1289810000</b>	<b>1289430000</b>
36	59,50	2,343	20	<b>1289820000</b>	<b>1289440000</b>

**S2C-SMT 3.50/./90LF Box**

With solder flange



Dimensioned drawing

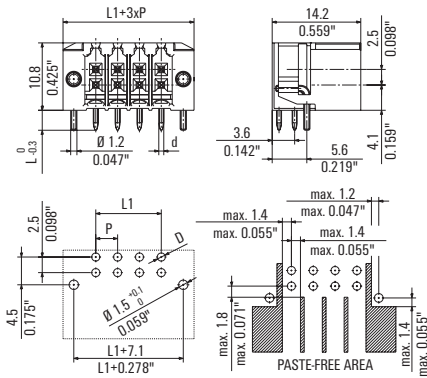

**Ordering data**

Solder pin length		1,5 mm	3,2 mm		
Colour		black	black		
<b>Pitch 3,50 mm</b>					
Pol.	L1	(inch)	Qty.	Order No.	Order No.
4	3,50	0,138	50	1289830000	1289450000
6	7,00	0,276	50	1289840000	1289460000
8	10,50	0,413	50	1289850000	1289470000
10	14,00	0,551	50	1289870000	1289480000
12	17,50	0,689	50	1289880000	1289490000
14	21,00	0,827	50	1289890000	1289500000
16	24,50	0,965	50	1289910000	1289510000
18	28,00	1,102	20	1289930000	1289520000
20	31,50	1,240	20	1289940000	1289530000
22	35,00	1,378	20	1289950000	1289540000
24	38,50	1,516	20	1289960000	1289550000
26	42,00	1,654	20	1289970000	1289570000
28	45,50	1,791	20	1289980000	1289580000
30	49,00	1,929	20	1289990000	1289590000
32	52,50	2,067	20	1290000000	1289600000
34	56,00	2,205	20	1290010000	1289610000
36	59,50	2,343	20	1290020000	1289620000

**S2C-SMT 3.50/./180G Box**

Closed side



Dimensioned drawing

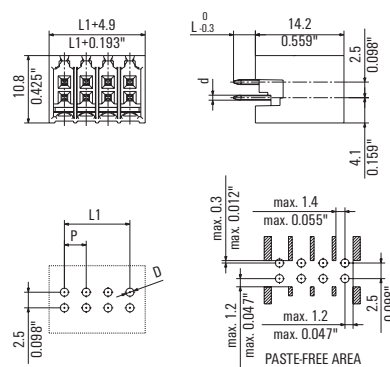

**Ordering data**

Solder pin length		1,5 mm	3,5 mm		
Colour		black	black		
<b>Pitch 3,50 mm</b>					
Pol.	L1	(inch)	Qty.	Order No.	Order No.
4	3,50	0,138	50	1290410000	1290030000
6	7,00	0,276	50	1290420000	1290040000
8	10,50	0,413	50	1290430000	1290050000
10	14,00	0,551	50	1290440000	1290060000
12	17,50	0,689	50	1290450000	1290070000
14	21,00	0,827	50	1290460000	1290080000
16	24,50	0,965	50	1290470000	1290090000
18	28,00	1,102	20	1290480000	1290110000
20	31,50	1,240	20	1290490000	1290120000
22	35,00	1,378	20	1290510000	1290130000
24	38,50	1,516	20	1290520000	1290140000
26	42,00	1,654	20	1290530000	1290150000
28	45,50	1,791	20	1290540000	1290160000
30	49,00	1,929	20	1290550000	1290170000
32	52,50	2,067	20	1290560000	1290180000
34	56,00	2,205	20	1290570000	1290190000
36	59,50	2,343	20	1290580000	1290210000

**S2C-SMT 3.50/./180LF Box**

With solder flange



Dimensioned drawing

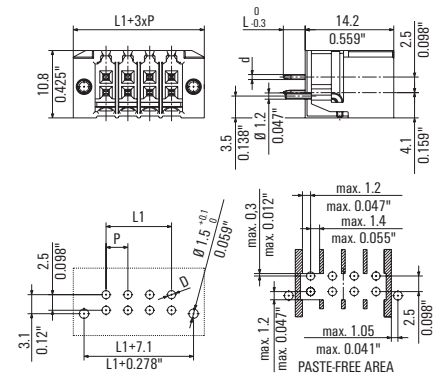

**Ordering data**

Solder pin length		1,5 mm	3,5 mm		
Colour		black	black		
<b>Pitch 3,50 mm</b>					
Pol.	L1	(inch)	Qty.	Order No.	Order No.
4	3,50	0,138	50	1290590000	1290220000
6	7,00	0,276	50	1290610000	1290230000
8	10,50	0,413	50	1290620000	1290240000
10	14,00	0,551	50	1290640000	1290250000
12	17,50	0,689	50	1290650000	1290260000
14	21,00	0,827	50	1290660000	1290270000
16	24,50	0,965	50	1290670000	1290280000
18	28,00	1,102	20	1290680000	1290290000
20	31,50	1,240	20	1290690000	1290310000
22	35,00	1,378	20	1290710000	1290320000
24	38,50	1,516	20	1290720000	1290330000
26	42,00	1,654	20	1290730000	1290340000
28	45,50	1,791	20	1290740000	1290350000
30	49,00	1,929	20	1290750000	1290360000
32	52,50	2,067	20	1290760000	1290370000
34	56,00	2,205	20	1290770000	1290380000
36	59,50	2,343	20	1290780000	1290390000

**Preliminary product data**

**B2C 3.50/././180**

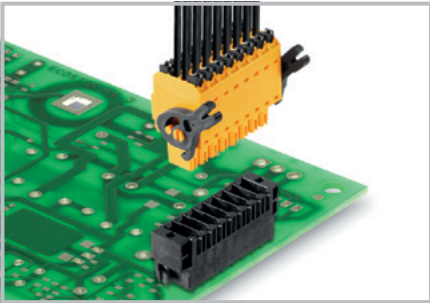

Double female plug with PUSH IN wire connection.

- Simply insert the prepared wire and it's ready.
- Intuitive handling – since the wire-entry area and handling area are clearly separated.
- Integrated push-button for opening the terminal point
- High component density because of low heights
- Optional: the lock and release requires no tools when using Weidmüller's patented (LR) release latch.
- Approval according to IEC 60335 and GL pending

**Product data**

IEC: 320 V / 10 A / 0,14 - 1,5 mm<sup>2</sup>  
 UL: 300 V / 10 A / AWG 26 - AWG 16

For additional articles and information, refer to [catalog.weidmueller.com](http://catalog.weidmueller.com)

**Note:**

- Gold-plated contact surface on request
- Crimping shape „A“ for wire end ferrules with PZ 1,5 crimping tools Order No. 9005990000 or PZ 6/5 Order No. 9011460000 recommended for the largest conductor cross-section
- Rated voltage referenced to rated cross-section and minimum poles
- Wire end ferrule without plastic collar to DIN 46228/1
- Wire end ferrule with plastic collar to DIN 46228/4
- P on drg. = pitch
- Rated data refer only to the component itself. Clearance and creepage distances to other components are to be designed in accordance with the relevant application standards.
- Compatible with Series S2L 3.50, S2L-SMT 3.50 and S2L 3.50

**B2CF 3.50/././180**



**Dimensioned drawing**

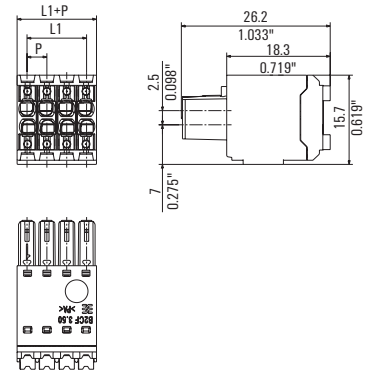

**Technical data**

In compliance with IEC 60664-1 / IEC 61984			
Clamping range, max.	mm <sup>2</sup>	0,14...1,5	
<b>Solid core H05(07) V-U</b>	<b>mm<sup>2</sup></b>	0,14...1,5	
Stranded H07 V-R			
Flexible H05(07) V-K	mm <sup>2</sup>	0,14...1,5	
Flexible with ferrule	mm <sup>2</sup>	0,14...1,5	
Ferrule with plastic collar	mm <sup>2</sup>	0,14...1	
Stripping length	mm	12	
Screwdriver blade	mm		
According to norm			
Tightening torque range	Nm		
<b>Rated current, max.</b>	<b>A</b>	<b>10,3</b>	<b>8,9</b>
At ambient temperature		20°C	40°C
For conductor cross-section	mm <sup>2</sup>	1	
Overvoltage category		III	III II
Pollution severity		3	2 2
<b>Rated voltage</b>	<b>V</b>	<b>160</b>	<b>160 320</b>
Rated impulse voltage	kV	2,5	2,5 2,5
<b>UL / CUL (Use Group)</b>	<b>B C D</b>		
<b>Rated voltage</b>	<b>V</b>		
<b>Rated current</b>	<b>A</b>		
<b>AWG conductor</b>	<b>AWG</b>		
<b>CSA (Use Group)</b>	<b>B C D</b>		
Rated voltage	V	300	
Rated current	A	5	
AWG conductor	AWG	26-16	
<b>General data</b>			
Type of insulation material		PA 66 GF 30	
Flammability class UL 94		V-0	
Contact base material		Copper alloy	
Material of contact surface		tinned	
Pin dimensions = d	mm		
Solder eyelet Ø = D	mm		
Solder eyelet Ø tolerance	mm		

**Accessories**

**Note:** Refer to the Accessories chapter for additional accessories.

Coding	Order No.
B2L/S2L 3.5 KO OR	<b>1849730000</b>
B2L/S2L 3.5 KO SW	<b>1849740000</b>
<b>Strain relief</b>	
BL 3.5 ZE 3 OR	<b>1629680000</b>
BL 3.5 ZE 3 SW	<b>1627820000</b>
BL 3.5 ZE 8 OR	<b>1629690000</b>
BL 3.5 ZE 8 SW	<b>1627830000</b>
<b>Screwdriver</b>	
SD 0,4x2,5x75	<b>9009030000</b>
<b>Crimping tool</b>	
PZ 1,5	<b>9005990000</b>
PZ 6/5	<b>9011460000</b>

**Ordering data**

Solder pin length					
Colour		orange	black		
Pitch 3,50 mm					
Pol.	L1	(inch)	Qty.	Order No.	Order No.
4	3,50	0,138	50	<b>1277270000</b>	<b>1277460000</b>
6	7,00	0,276	50	<b>1277280000</b>	<b>1277470000</b>
8	10,50	0,413	50	<b>1277290000</b>	<b>1277480000</b>
10	14,00	0,551	50	<b>1277310000</b>	<b>1277490000</b>
12	17,50	0,689	50	<b>1277320000</b>	<b>1277510000</b>
14	21,00	0,827	50	<b>1277330000</b>	<b>1277520000</b>
16	24,50	0,965	50	<b>1277340000</b>	<b>1277530000</b>
18	28,00	1,102	20	<b>1277350000</b>	<b>1277540000</b>
20	31,50	1,240	20	<b>1277360000</b>	<b>1277550000</b>
22	35,00	1,378	20	<b>1277370000</b>	<b>1277560000</b>
24	38,50	1,516	20	<b>1277380000</b>	<b>1277570000</b>
26	42,00	1,654	20	<b>1277390000</b>	<b>1277580000</b>
28	45,50	1,791	20	<b>1277410000</b>	<b>1277590000</b>
30	49,00	1,929	20	<b>1277420000</b>	<b>1277610000</b>
32	52,50	2,067	20	<b>1277430000</b>	<b>1277620000</b>
34	56,00	2,205	20	<b>1277440000</b>	<b>1277630000</b>
36	59,50	2,343	20	<b>1277450000</b>	<b>1277640000</b>

**Representative derating curve**

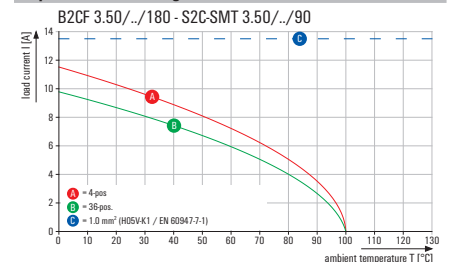

### B2CF 3.50/././180F

With flange



### B2CF 3.50/././180LR

With release lever



Dimensioned drawing

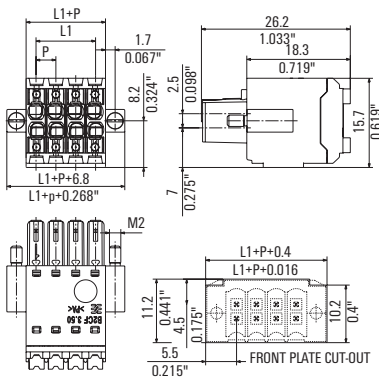

Dimensioned drawing

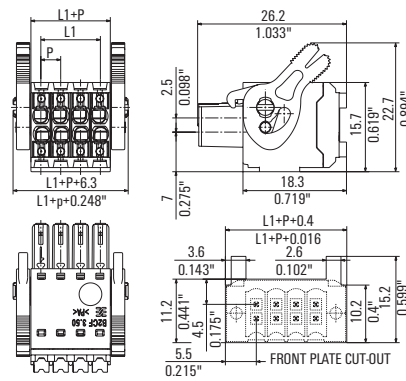

#### Ordering data



Solder pin length					
Colour		orange	black		
Pitch 3,50 mm					
Pol.	L1	(inch)	Qty.	Order No.	Order No.
4	3,50	0,138	50	1277650000	1277860000
6	7,00	0,276	50	1277670000	1277870000
8	10,50	0,413	50	1277680000	1277880000
10	14,00	0,551	50	1277690000	1277890000
12	17,50	0,689	50	1277720000	1277900000
14	21,00	0,827	50	1277730000	1277910000
16	24,50	0,965	50	1277740000	1277920000
18	28,00	1,102	20	1277750000	1277930000
20	31,50	1,240	20	1277760000	1277940000
22	35,00	1,378	20	1277770000	1277950000
24	38,50	1,516	20	1277780000	1277970000
26	42,00	1,654	20	1277790000	1277980000
28	45,50	1,791	20	1277810000	1277990000
30	49,00	1,929	20	1277820000	1278000000
32	52,50	2,067	20	1277830000	1278010000
34	56,00	2,205	20	1277840000	1278020000
36	59,50	2,343	20	1277850000	1278030000

#### Ordering data

Solder pin length					
Colour		orange	black		
Pitch 3,50 mm					
Pol.	L1	(inch)	Qty.	Order No.	Order No.
4	3,50	0,138	50	1278040000	1278230000
6	7,00	0,276	50	1278050000	1278240000
8	10,50	0,413	50	1278060000	1278250000
10	14,00	0,551	50	1278070000	1278260000
12	17,50	0,689	50	1278080000	1278270000
14	21,00	0,827	50	1278090000	1278280000
16	24,50	0,965	50	1278100000	1278290000
18	28,00	1,102	20	1278110000	1278300000
20	31,50	1,240	20	1278120000	1278310000
22	35,00	1,378	20	1278130000	1278320000
24	38,50	1,516	20	1278140000	1278340000
26	42,00	1,654	20	1278150000	1278350000
28	45,50	1,791	20	1278170000	1278370000
30	49,00	1,929	20	1278180000	1278380000
32	52,50	2,067	20	1278190000	1278390000
34	56,00	2,205	20	1278200000	1278400000
36	59,50	2,343	20	1278210000	1278410000

## Looking for pricing, stock, or lifecycle information?

Click below to explore more details on WIN SOURCE:

-  [View 1278230000 on WIN SOURCE](#)
-  [Weidmuller Information](#)

## Optimize Your Supply Chain with WIN SOURCE Solutions

-  Global Sourcing Solution
-  Obsolete Management
-  Cost Control Management
-  Shortage Management
-  Alternative Solution
-  Excess Inventory Management