



**THE DATASHEET OF
CR8420-1000-G**



High Ratio Wire Lead Transformers

CR Magnetics **CR8400** Series of Wire Lead Current Transformers are available in a wide range of sizes and materials to meet any AC current sensing needs. Our **General Purpose** designs are made from the highest quality silicon steel cores available, and meet most of the common AC current measurement needs. Our **Revenue Grade (-N)** are made from a nickel alloy core which provides the most linear response over temperature and current level. A line of **Ground Fault (-G)** are for measuring low AC currents including electrical shields.

Nanocrystalline (-A) is the most versatile providing accuracy, high saturation point and a linear response in high frequency applications. The **High Frequency (-F)** products are designed for high frequency applications such as high frequency power supplies and motor drives.

CR8400 SERIES



Applications

Motor Load Measurement
Power Meters
High Frequency Current Sensing
Ground Fault Sensing

Features

High Ratio
Custom Lead Lengths Available

Specifications

Maximum Continuous Primary Current 4 X Ir
Insulation Voltage 3500 Vac/1 min
Storage Temp. -45°C thru +85 °C
Operating Temp. General Purpose & Nickel -40°C thru +85 °C
Operating Temp. High Frequency -40°C thru +65 °C

Regulatory Agencies

CE, cULus, RoHS, IATF 16949:2016 recognized

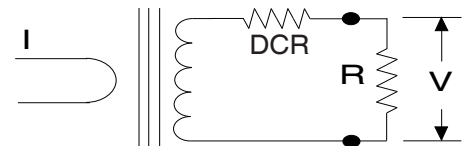

$$V_L = V_{max} - \left[\frac{I \times DCR}{T_e} \right] \quad V = \frac{I \times R}{T_e}$$

For best linearity, choose R such that $V < 0.8 V_L$

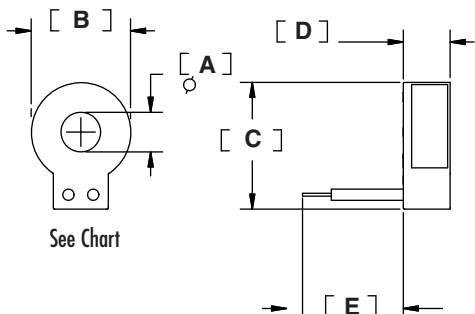
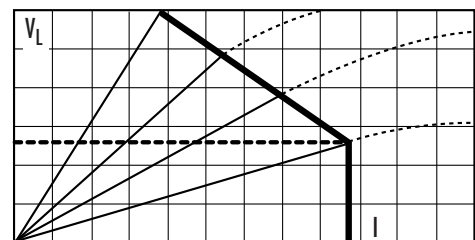

GENERAL PURPOSE CURRENT TRANSFORMERS					
Part Number	I _p	V _{max} RMS	T _e (typ.)	DCR Ω	Frequency
CR8401-1000	10	2.2	1009	49	20 Hz- 1 KHz
CR8410-1000	20	3.1	1012	41	20 Hz- 1 KHz
CR8420-1000	50	5.2	1018	22	20 Hz- 1 KHz
CR8420-2000	75	9.0	1983	90	20 Hz- 1 KHz
CR8448-1000	30	6.3	990	26	20 Hz- 1 KHz
CR8448-2000	50	13.7	2046	106	20 Hz- 1 KHz
CR8449-1000	50	11.6	1016	35	20 Hz- 1 KHz
CR8449-2000	75	23	2046	150	20 Hz- 1 KHz
CR8450-1000	100	16.5	1021	21	20 Hz- 1 KHz
CR8450-2000	200	32	2037	73	20 Hz- 1 KHz
REVENUE GRADE CURRENT TRANSFORMERS					
Part Number	I _p	V _{max} RMS	T _e (typ.)	DCR Ω	Frequency
CR8448-2500-N	40	6.6	2510	134	20 Hz- 1 KHz
CR8449-2500-N	50	10.0	2490	187	20 Hz- 1 KHz
CR8450-2500-N	75	12.0	2512	143	20 Hz- 1 KHz
CR8459-2000-N	200	11.5	2011	74	20 Hz- 1 KHz
GROUND FAULT CURRENT TRANSFORMERS					
Part Number	I _p	V _{max} RMS	T _e (typ.)	DCR Ω	Frequency
CR8401-1000-G	4	0.6	1005	49	20 Hz- 1 KHz
CR8410-1000-G	7	0.8	1007	38	20 Hz- 1 KHz
CR8420-1000-G	20	1.4	1011	44	20 Hz- 1 KHz
NANOCRYSTALLINE CURRENT TRANSFORMERS					
Part Number	I _p	V _{max} RMS	T _e (typ.)	DCR Ω	Frequency
CR8401-1000-A	4	2.2	1034	43	50 Hz- 50 KHz
CR8410-1000-A	7	2.5	1015	39	50 Hz- 50 KHz
CR8420-1000-A	20	1.3	1023	43	50 Hz- 50 KHz
CR8420-2000-A	75	7.0	2010	89	50 Hz- 50 KHz
CR8448-1000-A	20	6.0	1000	25	50 Hz- 50 KHz
CR8448-2000-A	50	13.0	2000	103	50 Hz- 50 KHz
CR8448-2500-A	50	16.0	2524	131	50 Hz- 50 KHz
CR8449-1000-A	75	11.0	1002	35	50 Hz- 50 KHz
CR8449-2000-A	75	16.0	2013	144	50 Hz- 50 KHz
CR8449-2500-A	75	27.0	2501	182	50 Hz- 50 KHz
CR8450-1000-A	100	15.0	1003	21	50 Hz- 50 KHz
CR8450-2000-A	100	26.0	2000	72	50 Hz- 50 KHz
CR8450-2500-A	100	28.0	2501	134	50 Hz- 50 KHz
CR8459-2000-A	100	27.0	2001	73	50 Hz- 50 KHz
HIGH FREQUENCY CURRENT TRANSFORMERS					
Part Number	I _p	V _{max} RMS	T _e (typ.)	DCR Ω	Frequency
CR8448-2000-F	50	3.9	2015	90	20 Hz- 200 KHz
CR8449-2000-F	75	7.4	2017	109	20 Hz- 200 KHz
CR8450-2000-F	100	8.5	2020	63	20 Hz- 200 KHz

I_p = Maximum AC Input Current to be linearly sensed V_{max} = Maximum VAC (Saturation) CT will develop

T_e = Effective turns ratio including losses (+/- 10%) (All Specifications tested at 60 Hz)

PACKAGE DIMENSIONS AND OUTLINE (mm/in)

Part Number Prefix	A	B	C	D	E
	min	max	max	max	Typ
CR8401	6.99	17.53	22.35	8.26	75.08
	.275	.690	.880	.325	2.275
CR8410	9.0	22	27.8	8.20	73
	.35	.87	1.09	.323	2.87
CR8420	15.0	30.0	36.0	9.2	100
	.59	1.18	1.41	.36	3.94
CR8448	7.11	23.42	29.46	11.05	100
	.280	.922	1.16	.435	3.94
CR8449	9.14	26.0	31.8	17.0	100
	.354	1.02	1.25	.67	3.94
CR8450	13.08	36.83	43.18	13.97	88.9
	.515	1.45	1.70	.55	3.50
CR8459	19	48	60	17.5	200
	.75	1.89	2.36	.67	7.88



3500 Scarlet Oak Blvd. St. Louis MO USA 63122 V: 636-343-8518 F: 636-343-5119

Web: <http://www.crmagnetics.com>

95 --

E-mail: sales@crmagnetics.com

Current Transformers

F

Looking for pricing, stock, or lifecycle information?

Click below to explore more details on WIN SOURCE:

 [View CR8420-1000-G on WIN SOURCE](#)

 [CR Magnetics Inc. Information](#)

Optimize Your Supply Chain with WIN SOURCE Solutions

-  Global Sourcing Solution
-  Obsolete Management
-  Cost Control Management
-  Shortage Management
-  Alternative Solution
-  Excess Inventory Management