



**THE DATASHEET OF
CR6622-100**



Frequency Transducer

DIN RAIL / PANEL MOUNT

The **CR6600** Series, Frequency Transducers and Transmitters are designed to give a DC output that is proportional to an input frequency value. These devices are especially suited to variable frequency systems.



CR6610
CR6611
CR6612

CR6620
CR6621
CR6622

40 - 5000 Hz Input Range

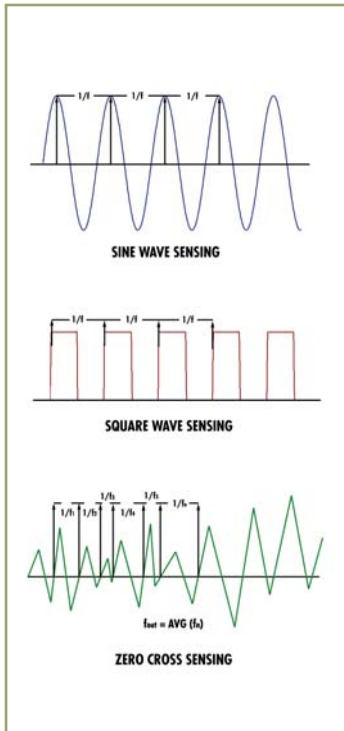

Applications

Outputs isolated from inputs
Ranges available for any application Sine, square and zero crossover waveforms
35 DIN rail or panel mount
Connection diagram printed on case

Features

35mm DIN Rail or Panel Mount
Available with 0 - 5 VDC, 0 - 10, or 4 - 20 mA DC output
24 VDC powered
Red LED Active Indication
Highest precision available
Connection diagram printed on case

Regulatory Agencies

Constructed to meet UL 61010B-1
Constructed to meet CAN/CSA-C22.2, No. 61010-1-2004
Meets requirement of IEC 61010-1 and BS EN 61010-1



E199795

Custom calibrations of unique full scale and zero scale values including parametric measurements are available. Contact factory for details.

Add suffix for input range

PART NUMBERS			
CR6610	-		Sine wave sensing with 0 - 5 VDC Output
CR6611	-		Square wave sensing with 0 - 5 VDC Output
CR6612	-		Zero crossover sensing with 0 - 5 VDC Output
CR6620	-		Sine wave sensing with 4 - 20 mADC Output
CR6621	-		Square wave sensing with 4 - 20 mADC Output
CR6622	-		Zero crossover sensing with 4 - 20 mADC Output

100 - 0-100 Hz
500 - 0-500 Hz
5000 - 0-5000 Hz
other ranges available

Frequency Transducer

DIN RAIL / PANEL MOUNT

SPECIFICATIONS

Basic Accuracy:.....	0.5%	Output Load:.....	4-20 mADC -0 to 500 Ω 0-5 VDC - 2K Ω or Greater
Linearity:.....	10% to 100% FS	Cleaning:.....	Water-dampened cloth
Thermal Drift:.....	500 PPM/ $^{\circ}$ C	Relative Humidity:.....	5% to 95%, Non-Condensing
Operating Temperature:.....	0 $^{\circ}$ C to +60 $^{\circ}$ C	Input Voltage:.....	20 to 250 V Peak, (other voltage ranges available)
Installation Category:.....	CAT II	Supply Current:	
Vibration Tested To:.....	IEC 60068-2-6,1995	CR6610:.....	Typical 30mA Max 40mA
Pollution Degree:.....	2	CR6620:.....	Typical 50mA Max 95mA
Response Time:	250 ms max. 0-90% FS	Torque Specs.:.....	3.0 inch lbs. (0.4Nm)
Supply Voltage:.....	24 VDC	Weight:.....	0.5 lbs.
MTBF:.....	Greater than 100 K hours		
Frequency Range:.....	0 Hz - 2kHz, sine wave		
Insulation Voltage:.....	2500 VDC		
Altitude:.....	2000 meter max.		

Transducers

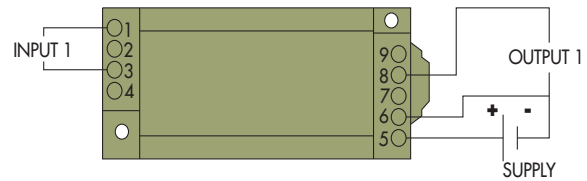
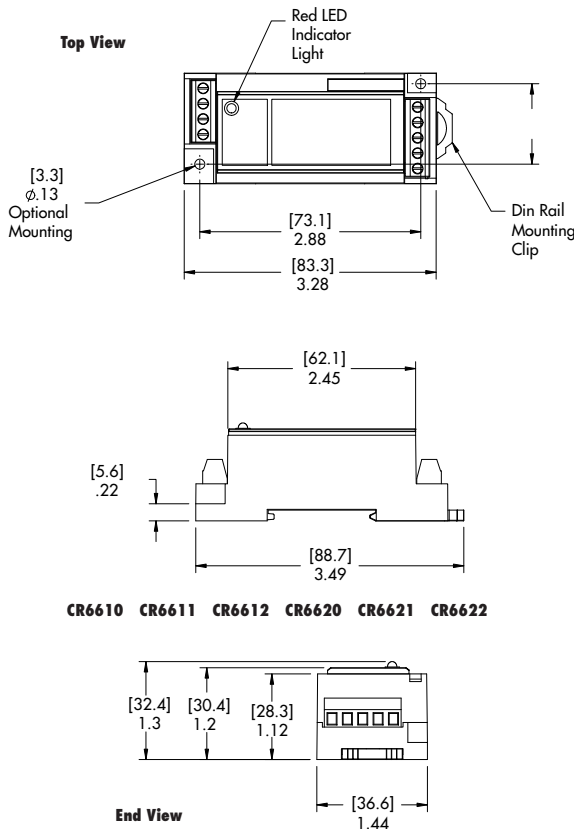

CR6610 0 - 5 VDC Output
CR6611 0 - 5 VDC Output
CR6612 0 - 5 VDC Output

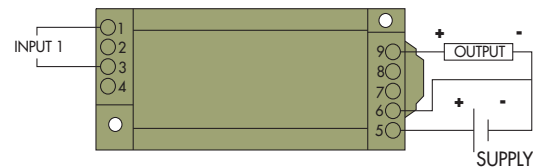

CR6620 4 - 20 mADC Output
CR6621 4 - 20 mADC Output
CR6622 4 - 20 mADC Output

OUTLINE DRAWING

CONNECTION DIAGRAM

NOTE: The building installation must have a switch or circuit-breaker that is in close proximity and within easy reach of the operator. The switch or circuit breaker shall be marked as the disconnecting device for the equipment.

Looking for pricing, stock, or lifecycle information?

Click below to explore more details on WIN SOURCE:

 [View CR6622-100 on WIN SOURCE](#)

 [CR Magnetics Inc. Information](#)

Optimize Your Supply Chain with WIN SOURCE Solutions

-  Global Sourcing Solution
-  Obsolete Management
-  Cost Control Management
-  Shortage Management
-  Alternative Solution
-  Excess Inventory Management