



**THE DATASHEET OF
CR5311-150**



DC Voltage Transducer

DIN RAIL / PANEL MOUNT



Single Element
0.1 - 600 VDC Input Range

If you need a relay output, use a **CR3595**.
See Section for Details.

The **CR5300** Series, DC Voltage Transducers and Transmitters, are designed to provide an output DC signal that is proportional to the input DC voltage. These devices are especially suited for applications with a current shunt to monitor DC current.

Applications

Power Supply over/under sensing
Battery chargers and systems
Mobile applications
Power sensing

Features

Output isolated from input
Available with 0-5 VDC, 0-10 VDC or 4 - 20 mADC outputs
35mm DIN rail or panel mount
Connection diagram printed on case

Regulatory Agencies

Recognized to meet UL 61010B-1
Constructed to meet CAN/CSA-C22.2, No. 61010-1-2004
Meets requirement of IEC 61010-1 and BS EN 61010-1

Transducers

CR5310 with Resistor Application is shown below (optional).

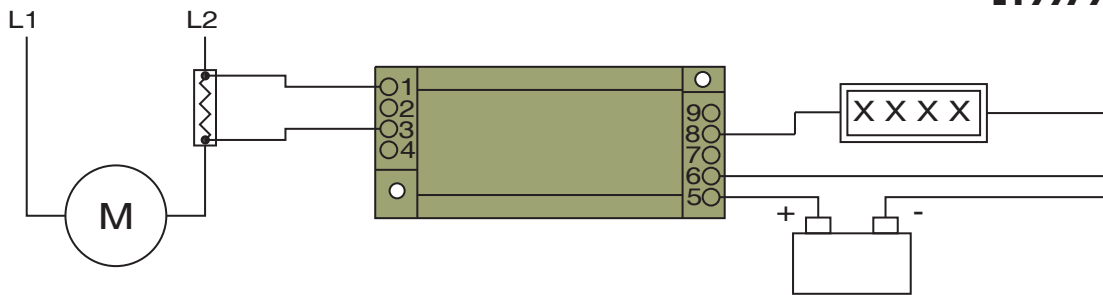

PART NUMBERS

CR5310	▪		Single Element with ± 5 VDC output
CR5311	▪		Single Element with ± 10 VDC output
CR5320	▪		Single Element with 4 - 20 mADC output

NOTE: CR5300 Series is available with 12V Power Supply. Use same application as 24V Power Supply.
Example Part Number: CR5310-300-12V

Add suffix for input range

- 1** - 0-1 VDC
- 5** - 0-5 VDC
- 10** - 0-10 VDC
- 50** - 0-50 VDC
- 150** - 0-150 VDC
- 200** - 0-200 VDC

Ranges available up to and including 1,000 VDC

*** UL Recognized up to 300 VDC**

DC Voltage Transducer

DIN RAIL / PANEL MOUNT

SPECIFICATIONS

Basic Accuracy:.....	1.0 %	Supply Voltage:.....	24 VDC \pm 10%
Linearity:.....	10% to 100% FS	Frequency Range:.....	DC only
Thermal Drift:.....	500 PPM/ $^{\circ}$ C	Output Load:.....	4-20 mADC - 0 to 500 Ω 0-5 VDC - 2K Ω or Greater
Operating Temperature:.....	0 $^{\circ}$ C to +50 $^{\circ}$ C	Relative Humidity:.....	5% to 95%, Non-Condensing
Installation Category:.....	CAT II	Supply Current:	
Isolation Voltage:.....	2500KVRMS/1mA/1Sec	CR5310:.....	Typical 35mA Max 40mA
Vibration Tested To:.....	IEC 60068-2-6,1995	CR5320:.....	Typical 35mA Max 40mA
Pollution Degree:.....	2	Torque Specs.:.....	3.0 inch lbs. (0.4Nm)
Altitude:.....	2000 meter max.	Weight:.....	0.5 lbs.
Response Time:	250 ms. max.		
Insulation Voltage:.....	2500 VDC		
Cleaning:.....	Water-dampened cloth		

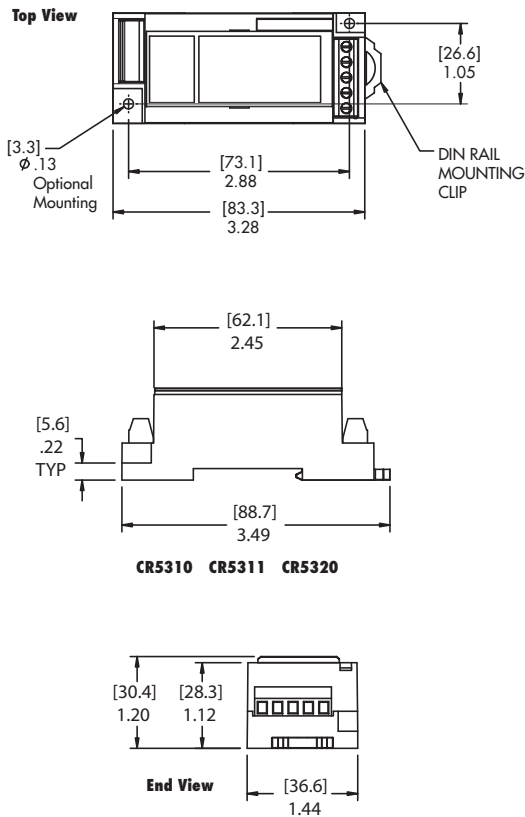

OUTLINE DRAWING

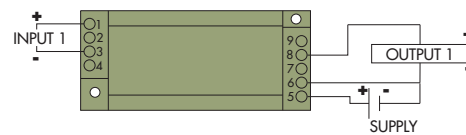

CR5310 5 VDC Output
CR5311 10 VDC Output

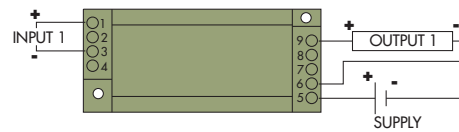

CR5320 4 - 20 mADC Output

CONNECTION DIAGRAM

NOTE: The building installation must have a switch or circuit-breaker that is in close proximity and within easy reach of the operator. The switch or circuit breaker shall be marked as the disconnecting device for the equipment.

Looking for pricing, stock, or lifecycle information?

Click below to explore more details on WIN SOURCE:

 [View CR5311-150 on WIN SOURCE](#)

 [CR Magnetics Inc. Information](#)

Optimize Your Supply Chain with WIN SOURCE Solutions

-  Global Sourcing Solution
-  Obsolete Management
-  Cost Control Management
-  Shortage Management
-  Alternative Solution
-  Excess Inventory Management