



**THE DATASHEET OF  
DS90CF581MTDX**



## DS90CF581/DS90CF582 LVDS 24-Bit Color Flat Panel Display (FPD) Link

### General Description

The DS90CF581 transmitter converts 28 bits of CMOS/TTL data into four LVDS (Low Voltage Differential Signaling) data streams. A phase-locked transmit clock is transmitted in parallel with the data streams over a fifth LVDS link. Every cycle of the transmit clock 28 bits of input data are sampled and transmitted. The DS90CF582 receiver converts the LVDS data streams back into 28 bits of CMOS/TTL data. At a transmit clock frequency of 40 MHz, 24 bits of RGB data and 4 bits of LCD timing and control data (FPLINE, FPFRAME, DRDY, CNTL) are transmitted at a rate of 280 Mbps per LVDS data channel. Using a 40 MHz clock, the data throughput is 140 Megabytes per second. The chipset is an ideal means to solve EMI and cable size problems associated with wide, high speed TTL interfaces.

### Features

- Up to 140 Megabyte/sec Bandwidth
- Narrow bus reduces cable size
- 345 mV swing LVDS devices for low EMI
- Low power CMOS design
- Power-down mode
- PLL requires no external components
- Low profile 56-lead TSSOP package
- Falling edge data strobe
- Compatible with TIA/EIA-644 LVDS standard

### Block Diagrams

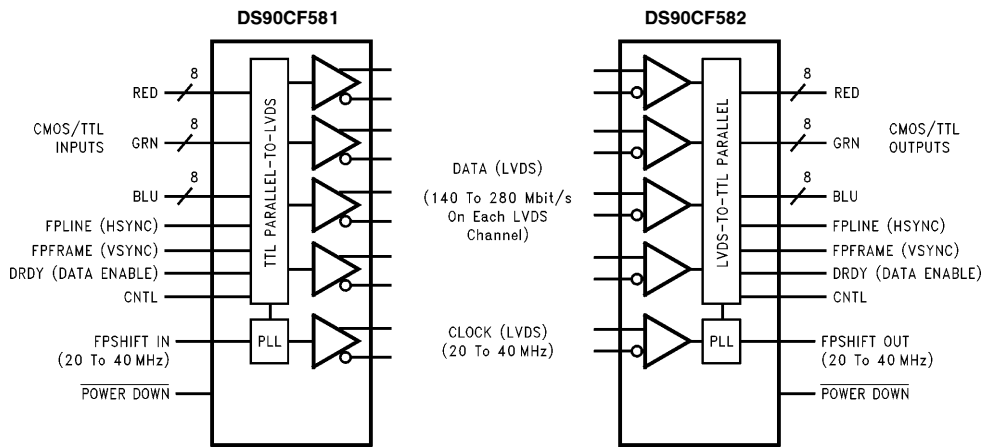

TL/F/12486-1

**Order Number DS90CF581MTD**  
See NS Package Number MTD56

**Order Number DS90CF582MTD**  
See NS Package Number MTD56

### Application

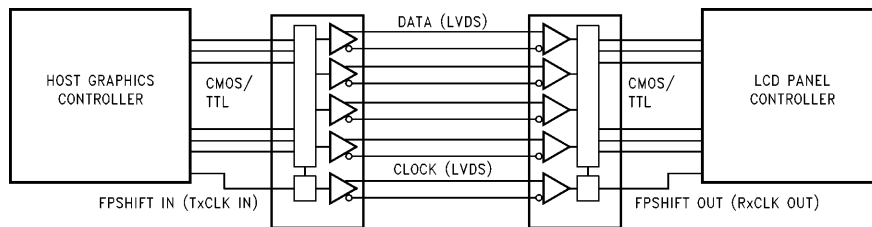

TL/F/12486-2

TRI-STATE® is a registered trademark of National Semiconductor Corporation.

# Connection Diagrams

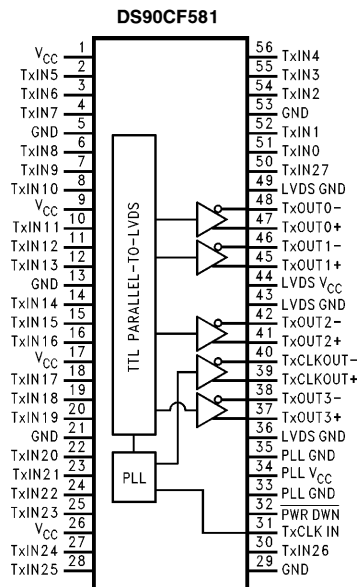

TL/F/12486-3

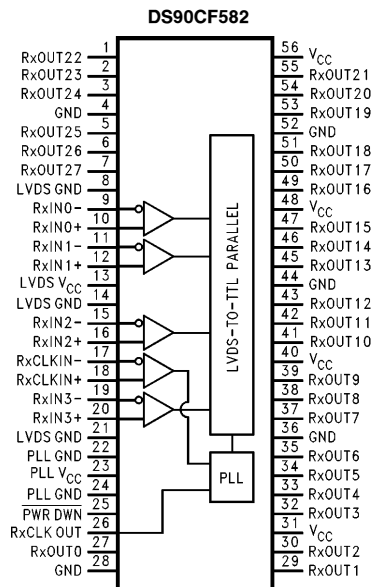

TL/F/12486-4

## Absolute Maximum Ratings (Note 1)

If Military/Aerospace specified devices are required, please contact the National Semiconductor Sales Office/Distributors for availability and specifications.

Supply Voltage ( $V_{CC}$ )	-0.3 to +6V
CMOS/TTL Input Voltage	-0.3 to ( $V_{CC} + 0.3V$ )
CMOS/TTL Output Voltage	-0.3 to ( $V_{CC} + 0.3V$ )
LVDS Receiver Input Voltage	-0.3 to ( $V_{CC} + 0.3V$ )
LVDS Driver Output Voltage	-0.3 to ( $V_{CC} + 0.3V$ )
LVDS Output Short Circuit Duration	continuous
Junction Temperature	+150°C
Storage Temperature Range	-65°C to +150°C
Lead Temperature (Soldering, 4 sec.)	+260°C

Maximum Package Power Dissipation @ +25°C	
MTD56 (TSSOP) Package: DS90CF581	1.63W
DS90CF582	1.61W
Derate Package: DS90CF581	12.5 mW/°C above +25°C
DS90CF582	12.4 mW/°C above +25°C
This device does not meet 2000V ESD rating. (Note 4)	

## Recommended Operating Conditions

	Min	Nom	Max	Units
Supply Voltage ( $V_{CC}$ )	4.5	5.0	5.5	V
Operating Free				
Air Temperature ( $T_A$ )	-10	+25	+70	°C
Receiver Input Range	0		2.4	V

## Electrical Characteristics

Over recommended operating supply and temperature ranges unless otherwise specified

Symbol	Parameter	Conditions	Min	Typ	Max	Units	
<b>CMOS/TTL DC SPECIFICATIONS</b>							
$V_{IH}$	High Level Input Voltage		2.0		$V_{CC}$	V	
$V_{IL}$	Low Level Input Voltage		GND		0.8	V	
$V_{OH}$	High Level Output Voltage	$I_{OH} = -0.4$ mA	3.8	4.9		V	
$V_{OL}$	Low Level Output Voltage	$I_{OL} = 2$ mA		0.1	0.3	V	
$V_{CL}$	Input Clamp Voltage	$I_{CL} = -18$ mA		-0.79	-1.5	V	
$I_{IN}$	Input Current	$V_{IN} = V_{CC}, GND, 2.5V$ or 0.4V		±5.1	±10	μA	
$I_{OS}$	Output Short Circuit Current	$V_{OUT} = 0V$			-120	mA	
<b>LVDS DRIVER DC SPECIFICATIONS</b>							
$V_{OD}$	Differential Output Voltage	$R_L = 100\Omega$	250	290	450	mV	
$\Delta V_{OD}$	Change in $V_{OD}$ between Complimentary Output States				35	mV	
$V_{CM}$	Common Mode Voltage		1.1	1.25	1.375	V	
$\Delta V_{CM}$	Change in $V_{CM}$ between Complimentary Output States				35	mV	
$V_{OH}$	High Level Output Voltage			1.3	1.6	V	
$V_{OL}$	Low Level Output Voltage		0.9	1.07		V	
$I_{OS}$	Output Short Circuit Current	$V_{OUT} = 0V, R_L = 100\Omega$		-2.9	-5	mA	
$I_{OZ}$	Output TRI-STATE® Current	Power Down = 0V, $V_{OUT} = 0V$ or $V_{CC}$		±1	±10	μA	
<b>LVDS RECEIVER DC SPECIFICATIONS</b>							
$V_{TH}$	Differential Input High Threshold	$V_{CM} = +1.2V$			+100	mV	
$V_{TL}$	Differential Input Low Threshold		-100			mV	
$I_{IN}$	Input Current	$V_{IN} = +2.4V$	$V_{CC} = 5.5V$			±10	μA
		$V_{IN} = 0V$				±10	μA

**Note 1:** "Absolute Maximum Ratings" are those values beyond which the safety of the device cannot be guaranteed. They are not meant to imply that the device should be operated at these limits. The tables of "Electrical Characteristics" specify conditions for device operation.

**Note 2:** Typical values are given for  $V_{CC} = 5.0V$  and  $T_A = +25^\circ C$ .

**Note 3:** Current into device pins is defined as positive. Current out of device pins is defined as negative. Voltages are referenced to ground unless otherwise specified (except  $V_{OD}$  and  $\Delta V_{OD}$ ).

**Note 4:** ESD Rating: HBM (1.5 kΩ, 100 pF)  
 PLL  $V_{CC} \geq 1000V$   
 All other pins  $\geq 2000V$   
 EIAJ (0Ω, 200 pF)  $\geq 150V$

## Electrical Characteristics (Continued)

Over recommended operating supply and temperature ranges unless otherwise specified

Symbol	Parameter	Conditions	Min	Typ	Max	Units	
<b>TRANSMITTER SUPPLY CURRENT</b>							
I <sub>CCTW</sub>	Transmitter Supply Current, Worst Case	R <sub>L</sub> = 100Ω, C <sub>L</sub> = 5 pF, Worst Case Pattern (Figures 1, 3)	f = 32.5 MHz		34	46	mA
			f = 37.5 MHz		36	48	mA
I <sub>CCTG</sub>	Transmitter Supply Current, 16 Grayscale	R <sub>L</sub> = 100Ω, C <sub>L</sub> = 5 pF, Grayscale Pattern (Figures 2, 3)	f = 32.5 MHz		27	42	mA
			f = 37.5 MHz		28	43	mA
I <sub>CCTZ</sub>	Transmitter Supply Current, Power Down	Power Down = Low		1	10	μA	
<b>RECEIVER SUPPLY CURRENT</b>							
I <sub>CCRW</sub>	Receiver Supply Current, Worst Case	C <sub>L</sub> = 8 pF, Worst Case Pattern (Figures 1, 4)	f = 32.5 MHz		55	75	mA
			f = 37.5 MHz		60	80	mA
I <sub>CCRG</sub>	Receiver Supply Current, 16 Grayscale	C <sub>L</sub> = 8 pF, 16 Grayscale Pattern (Figures 2, 4)	f = 32.5 MHz		35	55	mA
			f = 37.5 MHz		37	58	mA
I <sub>CCRZ</sub>	Receiver Supply Current, Power Down	Power Down = Low		1	10	μA	

## Switching Characteristics

Over recommended operating supply and temperature ranges unless otherwise specified

Symbol	Parameter	Min	Typ	Max	Units	
LLHT	LVDS Low-to-High Transition Time (Figure 3)		0.75	1.5	ns	
LHLT	LVDS High-to-Low Transition Time (Figure 3)		0.75	1.5	ns	
CLHT	CMOS/TTL Low-to-High Transition Time (Figure 4)		3.5	6.5	ns	
CHLT	CMOS/TTL High-to-Low Transition Time (Figure 4)		2.7	6.5	ns	
TCIT	TxCLK IN Transition Time (Figure 5)			8	ns	
TCCS	TxOUT Channel-to-Channel Skew (Note A) (Figure 6)			350	ps	
TSSPW	Tx Sub-Symbol Pulse Width (Figure 6)	f = 20 MHz	5.5	7	8	ns
RCCS	RxIN Channel-to-Channel Skew (Note B)			700	ps	
TCIP	TxCLK IN Period (Figure 7)	25	T	50	ns	
TCIH	TxCLK IN High Time (Figure 7)	0.35T	0.5T	0.65T	ns	
TCIL	TxCLK IN Low Time (Figure 7)	0.35T	0.5T	0.65T	ns	
TSTC	TxIN Setup to TxCLK IN (Figure 7)	8			ns	
THTC	TxIN Hold to TxCLK IN (Figure 7)	2.5	2		ns	
RCOP	RxCLK OUT Period (Figure 8)	25	T	50	ns	

**Note A:** This limit based on bench characterization.

**Note B:** This limit assumes a maximum cable skew of 350 ps.

## Switching Characteristics

Over recommended operating supply and temperature ranges unless otherwise specified (Continued)

Symbol	Parameter		Min	Typ	Max	Units
RCOH	RxCLK OUT High Time (Figure 8)	f = 20 MHz	21.5			ns
		f = 40 MHz	10.5			ns
RCOL	RxCLK OUT Low Time (Figure 8)	f = 20 MHz	19			ns
		f = 40 MHz	6			ns
RSRC	RxOUT Setup to RxCLK OUT (Figure 8)	f = 20 MHz	14			ns
		f = 40 MHz	4.5			ns
RHRC	RxOUT Hold to RxCLK OUT (Figure 8)	f = 20 MHz	16			ns
		f = 40 MHz	6.5			ns
TCCD	TxCLK IN to TxCLK OUT Delay @ 25°C, V <sub>CC</sub> = 5.0V (Figure 9)		5		9.7	ns
RCCD	RxCLK IN to RxCLK OUT Delay @ 25°C, V <sub>CC</sub> = 5.0V (Figure 10)		7.6		11.9	ns
TPLLS	Transmitter Phase Lock Loop Set (Figure 11)				10	ms
RPLLS	Receiver Phase Lock Loop Set (Figure 12)				10	ms

## AC Timing Diagrams

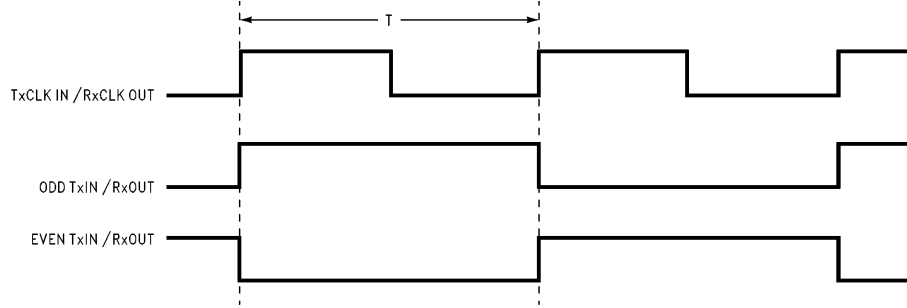

FIGURE 1. "WORST CASE" Test Pattern

TL/F/12486-15

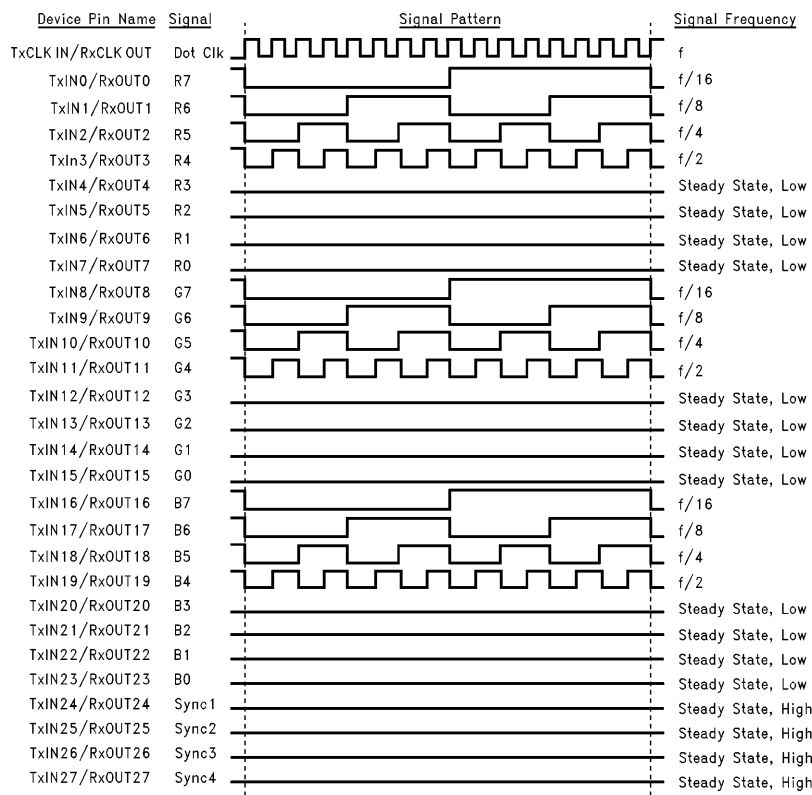

FIGURE 2. "16 GRAYSCALE" Test Pattern

TL/F/12486-16

**Note 1:** The worst case test pattern produces a maximum toggling of digital circuits, LVDS I/O and CMOS/TTL I/O.

**Note 2:** The 16 grayscale test pattern tests device power consumption for a "typical" LCD display pattern. The test pattern approximates signal switching needed to produce groups of 16 vertical stripes across the display.

**Note 3:** Figure 1 and Figure 2 show a falling edge data strobe (TxCLK IN/RxCLK OUT).

## AC Timing Diagrams (Continued)

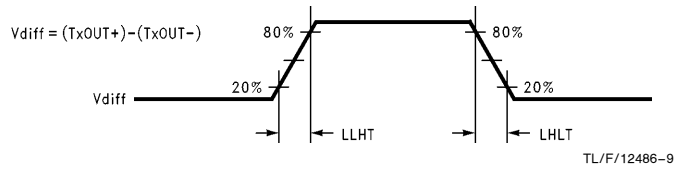
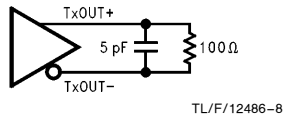

FIGURE 3. DS90CF581 (Transmitter) LVDS Output Load and Transition Timing

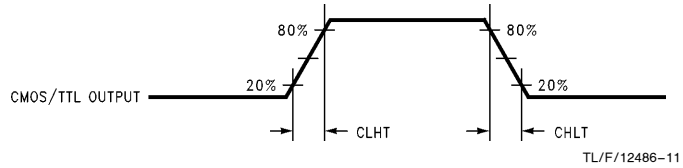
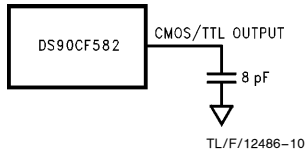

FIGURE 4. DS90CF582 (Receiver) CMOS/TTL Output Load and Transition Timing

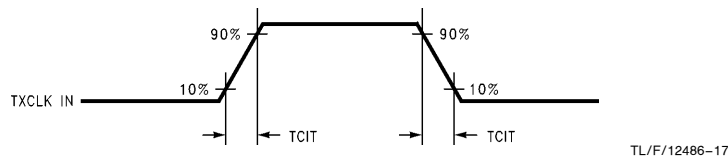

FIGURE 5. DS90CF581 (Transmitter) Input Clock Transition Time

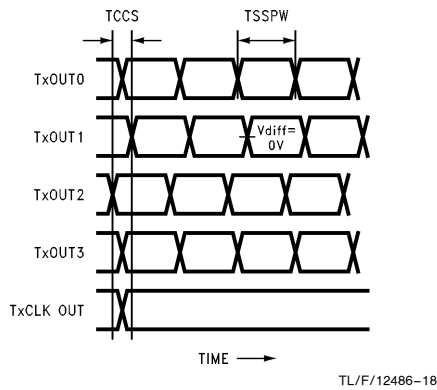
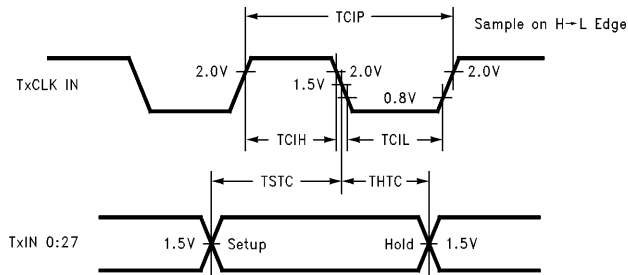

FIGURE 6. DS90CF581 (Transmitter) Channel-to-Channel Skew and Pulse Width

- Note 1:** Measurements at  $V_{diff} = 0V$
- Note 2:** TCCS measured between earliest and latest initial LVDS edges.
- Note 3:** TxCLK OUT Differential High → Low Edge for DS90CF561  
TxCLK OUT Differential Low → High Edge for DS90CR561

## AC Timing Diagrams (Continued)



TL/F/12486-12

**FIGURE 7. DS90CF581 (Transmitter) Setup/Hold and High/Low Times**

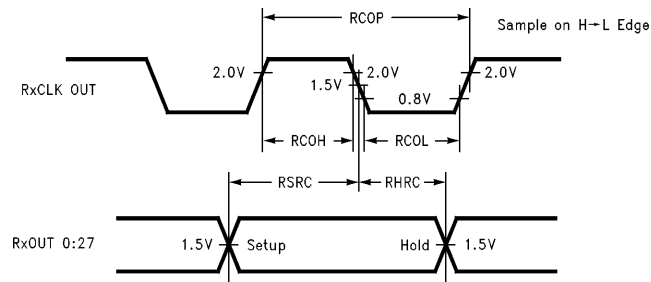

TL/F/12486-13

**FIGURE 8. DS90CF582 (Receiver) Setup/Hold and High/Low Times**

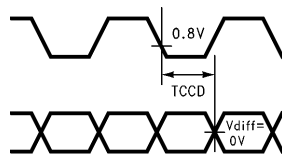

TL/F/12486-19

**FIGURE 9. DS90CF581 (Transmitter) Clock In to Clock Out Delay**

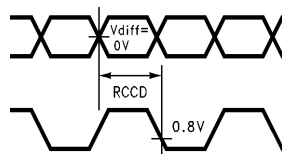

TL/F/12486-20

**FIGURE 10. DS90CF582 (Receiver) Clock In to Clock Out Delay**

## AC Timing Diagrams (Continued)

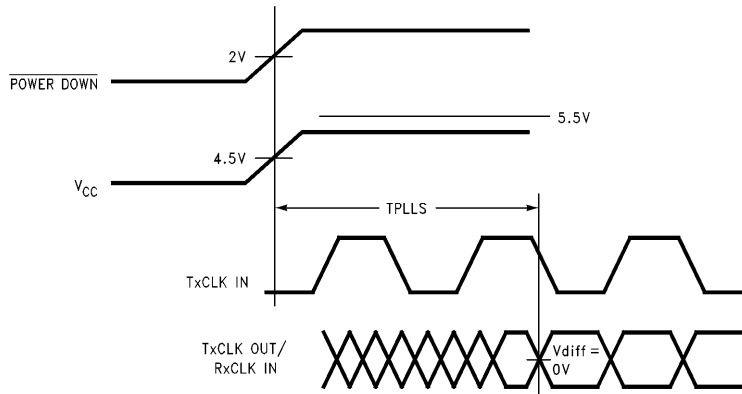

TL/F/12486-14

**FIGURE 11. DS90CF581 (Transmitter) Phase Lock Loop Set Time**

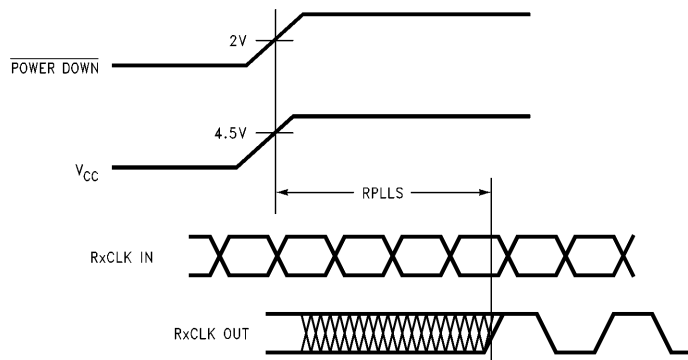

TL/F/12486-21

**FIGURE 12. DS90CF582 (Receiver) Phase Lock Loop Set Time**

## AC Timing Diagrams (Continued)

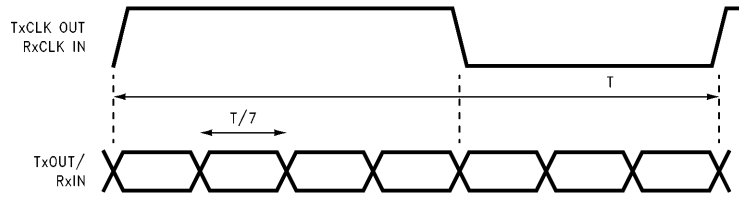

TL/F/12486-22

**FIGURE 13. Seven Bits of LVDS in One Block Cycle**

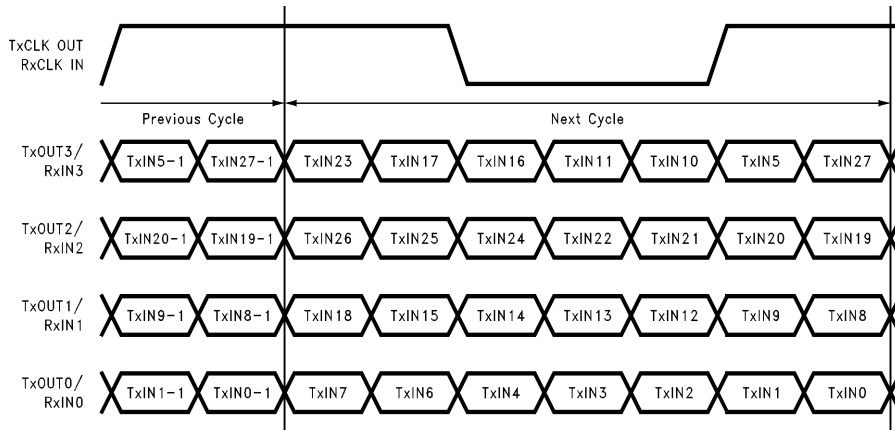

TL/F/12486-23

**FIGURE 14. 28 Parallel TTL Data Inputs Mapped to LVDS Outputs (DS90CF581)**

### DS90CF581 Pin Description—FPD Link Transmitter

Pin Name	I/O	No.	Description
TxIN	I	28	TTL level input. This includes: 8 Red, 8 Green, 8 Blue, and 4 control lines (FPLINE, FPFRAME, DRDY, CNTL). (Also referred to as HSYNC, VSYNC and DATA ENABLE)
TxOUT+	O	4	Positive LVDS differential data output
TxOUT-	O	4	Negative LVDS differential data output
FPSHIFT IN	I	1	TTL level clock input. The falling edge acts as data strobe.
TxCLK OUT+	O	1	Positive LVDS differential clock output
TxCLK OUT-	O	1	Negative LVDS differential clock output
PWR DOWN	I	1	TTL level input. Assertion (low input) TRI-STATE the outputs, ensuring low current at power down.
V <sub>CC</sub>	I	4	Power supply pins for TTL inputs
GND	I	5	Ground pins for TTL inputs
PLL V <sub>CC</sub>	I	1	Power supply pin for PLL
PLL GND	I	2	Ground pins for PLL
LVDS V <sub>CC</sub>	I	1	Power supply pin for LVDS outputs
LVDS GND	I	3	Ground pins for LVDS outputs

### DS90CF582 Pin Description—FPD Link Receiver

Pin Name	I/O	No.	Description
RxIN+	I	4	Positive LVDS differential data inputs.
RxIN-	I	4	Negative LVDS differential data inputs.
RxOUT	O	28	TTL level data outputs. This includes: 8 Red, 8 Green, 8 Blue, and 4 control lines (FPLINE, FPFRAME, DRDY, CNTL). (Also referred to as HSYNC, VSYNC and DATA ENABLE)
RxCLK IN+	I	1	Positive LVDS differential clock input
RxCLK IN-	I	1	Negative LVDS differential clock input
FPSHIFT OUT	O	1	TTL level clock output. The falling edge acts as data strobe.
PWR DOWN	I	1	TTL level input. Assertion (low input) maintains the receiver outputs in the previous state
V <sub>CC</sub>	I	4	Power supply pins for TTL outputs
GND	I	5	Ground pins for TTL outputs
PLL V <sub>CC</sub>	I	1	Power supply pin for PLL
PLL GND	I	2	Ground pin for PLL
LVDS V <sub>CC</sub>	I	1	Power supply pin for LVDS inputs
LVDS GND	I	3	Ground pins for LVDS inputs

**Physical Dimensions** inches (millimeters) unless otherwise noted

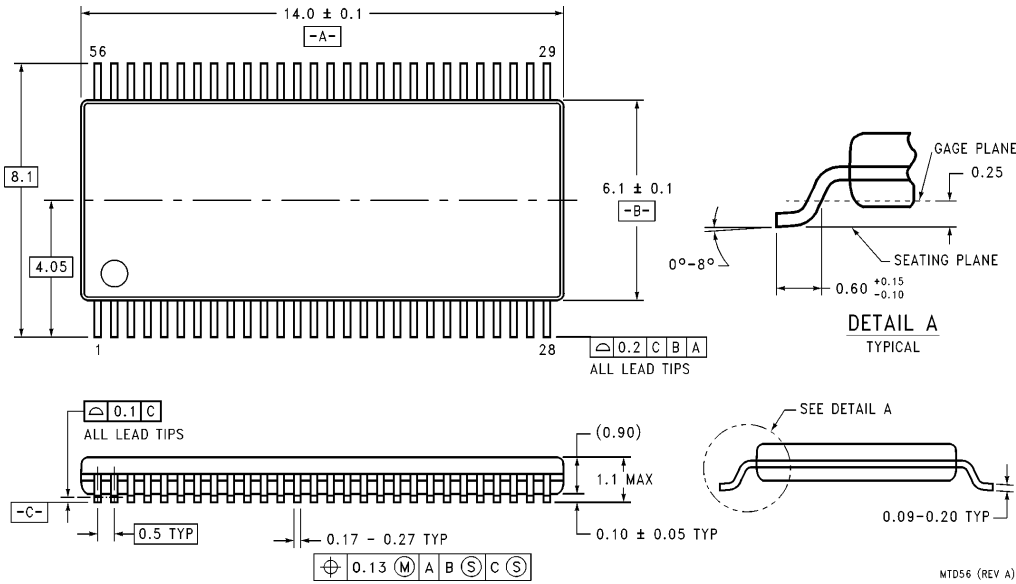

**56-Lead Molded Thin Shrink Small Outline Package, JEDEC**  
**Order Number DS90CF581MTD or DS90CF582MTD**  
**NS Package Number MTD56**

MTD56 (REV A)

**LIFE SUPPORT POLICY**

NATIONAL'S PRODUCTS ARE NOT AUTHORIZED FOR USE AS CRITICAL COMPONENTS IN LIFE SUPPORT DEVICES OR SYSTEMS WITHOUT THE EXPRESS WRITTEN APPROVAL OF THE PRESIDENT OF NATIONAL SEMICONDUCTOR CORPORATION. As used herein:

1. Life support devices or systems are devices or systems which, (a) are intended for surgical implant into the body, or (b) support or sustain life, and whose failure to perform, when properly used in accordance with instructions for use provided in the labeling, can be reasonably expected to result in a significant injury to the user.
2. A critical component is any component of a life support device or system whose failure to perform can be reasonably expected to cause the failure of the life support device or system, or to affect its safety or effectiveness.

 <p><b>National Semiconductor Corporation</b>          1111 West Bardin Road          Arlington, TX 76017          Tel: 1(800) 272-9959          Fax: 1(800) 737-7018  <a href="http://www.national.com">http://www.national.com</a></p>	<p><b>National Semiconductor Europe</b></p> <p>Fax: +49 (0) 180-530 85 86          Email: <a href="mailto:europe.support@nsc.com">europe.support@nsc.com</a>          Deutsch Tel: +49 (0) 180-530 85 85          English Tel: +49 (0) 180-532 78 32          Français Tel: +49 (0) 180-532 93 58          Italiano Tel: +49 (0) 180-534 16 80</p>	<p><b>National Semiconductor Hong Kong Ltd.</b>          19th Floor, Straight Block,          Ocean Centre, 5 Canton Rd.          Tsimshatsui, Kowloon          Hong Kong          Tel: (852) 2737-1600          Fax: (852) 2736-9960</p>	<p><b>National Semiconductor Japan Ltd.</b>          Tel: 81-043-299-2308          Fax: 81-043-299-2408</p>
---	--	---	---

National does not assume any responsibility for use of any circuitry described, no circuit patent licenses are implied and National reserves the right at any time without notice to change said circuitry and specifications.

## Looking for pricing, stock, or lifecycle information?

Click below to explore more details on WIN SOURCE:

 [View DS90CF581MTDX](#) on WIN SOURCE

 [Texas Instruments](#) Information

## Optimize Your Supply Chain with WIN SOURCE Solutions

-  Global Sourcing Solution
-  Obsolete Management
-  Cost Control Management
-  Shortage Management
-  Alternative Solution
-  Excess Inventory Management