



THE DATASHEET OF CR4640-50



Loop-Powered AC Voltage Transmitter

DIN RAIL / PANEL MOUNT, AVERAGE RMS

The **CR4600** Series, Loop-Powered AC Voltage Transmitters are designed to provide a 4 - 20 mADC output that is proportional to the average RMS AC voltage input. These devices are best suited for general applications, such as fixed frequency voltage supplies.



CR4620
Single Element Transmitter 1.0 to 600 VAC Input Range



CR4640
Two Element Transmitter 1.0 to 600 VAC Input Range

CR Magnetics has a wide selection of Potential Transformers to extend the range of any part.
Contact factory for more information.

Applications

- Monitor for over/under voltage
- Sense phase loss
- Power monitoring
- Multi-point instrumentation needs

Features

- 35mm DIN Rail or Panel Mount
- Outputs isolated from inputs
- One or two element
- Connection diagram printed on case

Regulatory Agencies

- Recognized to meet UL 61010B-1
- Constructed to meet CAN/CSA-C22.2, No. 61010-1-2004
- Meets requirement of IEC 61010-1 and BS EN 61010-1

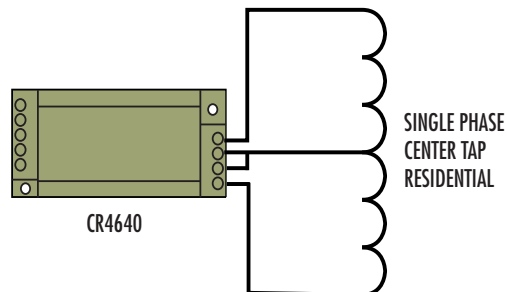

TYPICAL APPLICATION RESIDENTIAL POWER

PART NUMBERS			
CR4620	-		Single element with 4 - 20 mADC output
CR4640	-		Two element with 4 - 20 mADC output

□ Add suffix for input range

- 50** - 0-50 VAC
- 150** - 0-150 VAC
- 250** - 0-250 VAC
- 500** - 0-500 VAC *

Ranges available up to and including 600 VAC

* UL Recognized up to 300 Vac

Transducers

Loop-Powered AC Voltage Transmitter

DIN RAIL / PANEL MOUNT, AVERAGE RMS

SPECIFICATIONS

Basic Accuracy:.....	0.5%	Cleaning:.....	Water-dampened cloth
Calibration:.....	Average Sensing, RMS Calibrated	MTBF:.....	Greater than 100 K hours
Thermal Drift:.....	500 PPM/°C	Frequency Range:....	20 Hz - 400 Hz
Operating Temperature:.....	0°C to + 60°C	Typical Load:.....	0 - 500 Ω @ 24 VDC
Installation Category:.....	CAT II	Relative Humidity:.....	5% to 95%, Non-Condensing
Vibration Tested To:.....	IEC 60068-2-6,1995	Torque Specs.:.....	3.0 inch lbs. (0.4Nm)
Pollution Degree:.....	2	Weight:.....	0.5 lbs.
Response Time:	250 ms		
Altitude:.....	2000 meter max.		
Insulation Voltage:.....	2500 VDC		
Supply Voltage:.....	Loop Powered 24 Vdc ±10%		

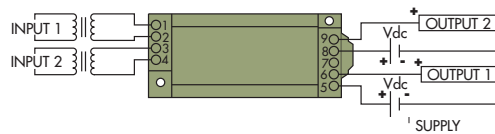
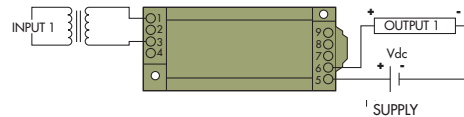
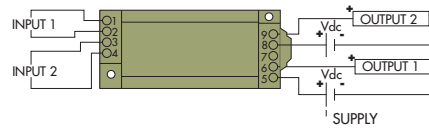
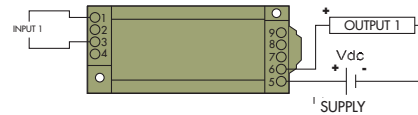
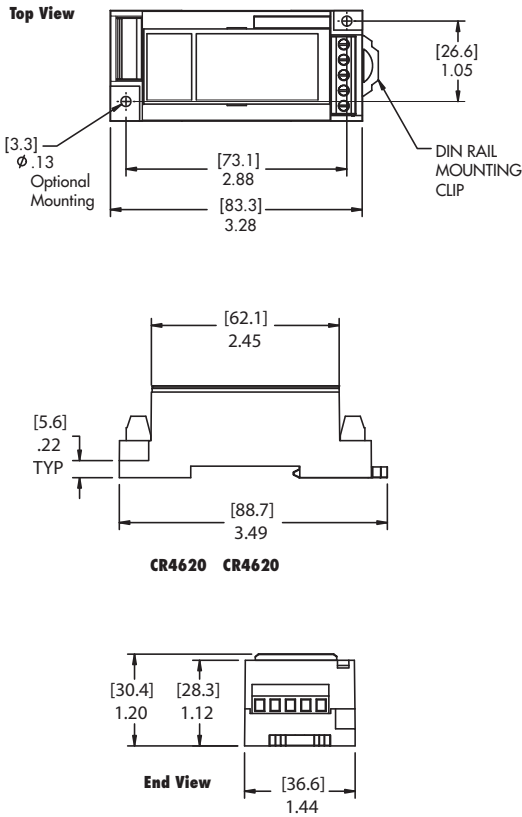

OUTLINE DRAWING



CONNECTION DIAGRAM

** USE CR MAGNETICS LOW AND MEDIUM VOLTAGE POTENTIAL TRANSFORMERS (SECTION G)

NOTE: The building installation must have a switch or circuit-breaker that is in close proximity and within easy reach of the operator. The switch or circuit breaker shall be marked as the disconnecting device for the equipment.

Looking for pricing, stock, or lifecycle information?

Click below to explore more details on WIN SOURCE:

-  [View CR4640-50 on WIN SOURCE](#)
-  [CR Magnetics Inc. Information](#)

Optimize Your Supply Chain with WIN SOURCE Solutions

-  Global Sourcing Solution
-  Obsolete Management
-  Cost Control Management
-  Shortage Management
-  Alternative Solution
-  Excess Inventory Management