



**THE DATASHEET OF
DS90C032BTMX/NOPB**



DS90C032B LVDS Quad CMOS Differential Line Receiver

Check for Samples: [DS90C032B](#)

FEATURES

- >155.5 Mbps (77.7 MHz) Switching Rates
- Accepts Small Swing (350 mV) Differential Signal Levels
- High Impedance LVDS Inputs with Power Down
- Ultra Low Power Dissipation
- 600 ps Maximum Differential Skew (5V, 25°C)
- 6.0 ns Maximum Propagation Delay
- Industrial Operating Temperature Range
- Available in Surface Mount Packaging (SOIC)
- Pin Compatible with DS26C32A, MB570 (PECL) and 41LF (PECL)
- Supports OPEN and Terminated Input Failsafe
- Conforms to ANSI/TIA/EIA-644 LVDS Standard

DESCRIPTION

The DS90C032B is a quad CMOS differential line receiver designed for applications requiring ultra low power dissipation and high data rates. The device supports data rates in excess of 155.5 Mbps (77.7 MHz) and uses Low Voltage Differential Signaling (LVDS) technology.

The DS90C032B accepts low voltage (350 mV) differential input signals and translates them to CMOS (TTL compatible) output levels. The receiver supports a TRI-STATE function that may be used to multiplex outputs. The receiver also supports OPEN Failsafe and terminated (100Ω) input Failsafe with the addition of external failsafe biasing. Receiver output will be HIGH for both Failsafe conditions.

The DS90C032B provides power-off high impedance LVDS inputs. This feature assures minimal loading effect on the LVDS bus lines when V_{CC} is not present.

The DS90C032B and companion line driver (DS90C031B) provide a new alternative to high power pseudo-ECL devices for high-speed point-to-point interface applications.

Connection Diagram

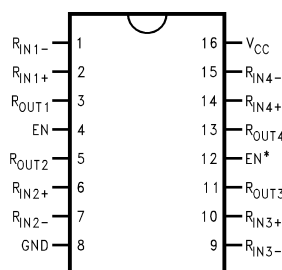
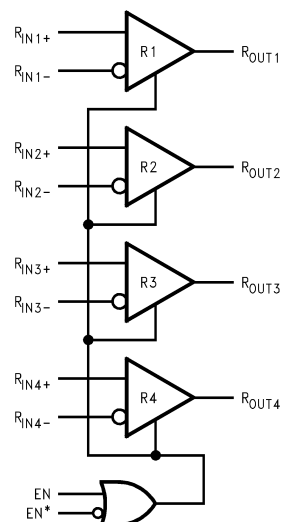

Figure 1. Dual-In-Line Top View
See Package Number D (R-PDSO-G16)

Functional Diagram



Please be aware that an important notice concerning availability, standard warranty, and use in critical applications of Texas Instruments semiconductor products and disclaimers thereto appears at the end of this data sheet.

All trademarks are the property of their respective owners.

Table 1. Receiver Truth Table

ENABLES		INPUTS	OUTPUT
EN	EN*	R _{IN+} – R _{IN-}	R _{OUT}
L	H	X	Z
All other combinations of ENABLE inputs		V _{ID} ≥ 0.1V	H
		V _{ID} ≤ -0.1V	L
		Failsafe OPEN or Terminated	H



These devices have limited built-in ESD protection. The leads should be shorted together or the device placed in conductive foam during storage or handling to prevent electrostatic damage to the MOS gates.

Absolute Maximum Ratings⁽¹⁾

Supply Voltage (V _{CC})		-0.3V to +6V
Input Voltage (R _{IN+} , R _{IN-})		-0.3V to +5.8V
Enable Input Voltage (EN, EN*)		-0.3V to (V _{CC} + 0.3V)
Output Voltage (R _{OUT})		-0.3V to (V _{CC} + 0.3V)
Maximum Package Power Dissipation at +25°C		1025 mW
Derate Power Dissipation		8.2 mW/°C above +25°C
Storage Temperature Range		-65°C to +150°C
Maximum Lead Temperature, Soldering (4 seconds)		+260°C
Maximum Junction Temperature		+150°C
ESD Ratings	HBM, 1.5 kΩ, 100 pF	≥ 2kV
	EIAJ, 0 Ω, 200 pF	≥ 250V

(1) "Absolute Maximum Ratings" are those values beyond which the safety of the device cannot be ensured. They are not meant to imply that the devices should be operated at these limits. "Electrical Characteristics" specifies conditions of device operation.

Recommended Operating Conditions

	Min	Typ	Max	Units
Supply Voltage (V _{CC})	+4.5	+5.0	+5.5	V
Receiver Input Voltage	GND		2.4	V
Operating Free Air Temperature (T _A)	-40	+25	+85	°C

Electrical Characteristics

Over Supply Voltage and Operating Temperature ranges, unless otherwise specified⁽¹⁾⁽²⁾

Symbol	Parameter	Conditions	Pin	Min	Typ	Max	Units
V _{TH}	Differential Input High Threshold	V _{CM} = +1.2V	R _{IN+} , R _{IN-}			+100	mV
V _{TL}	Differential Input Low Threshold			-100			mV
I _{IN}	Input Current	V _{IN} = +2.4V	V _{CC} = 5.5V or 0V	-10	±1	+10	µA
		V _{IN} = 0V		-10	±1	+10	µA
V _{OH}	Output High Voltage	I _{OH} = -0.4 mA, V _{ID} = +200 mV	R _{OUT}	3.8	4.9		V
		I _{OH} = -0.4 mA, Input terminated		3.8	4.9		V
V _{OL}	Output Low Voltage	I _{OL} = 2 mA, V _{ID} = -200 mV	R _{OUT}		0.07	0.3	V
I _{OS}	Output Short Circuit Current	Enabled, V _{OUT} = 0V ⁽³⁾		-15	-60	-100	mA
I _{OZ}	Output TRI-STATE Current	Disabled, V _{OUT} = 0V or V _{CC}		-10	±1	+10	µA
V _{IH}	Input High Voltage		EN, EN*	2.0			V
V _{IL}	Input Low Voltage					0.8	V
I _I	Input Current			-10	±1	+10	µA
V _{CL}	Input Clamp Voltage	I _{CL} = -18 mA		-1.5	-0.8		V
I _{CC}	No Load Supply Current, Receivers Enabled	EN, EN* = V _{CC} or GND, Inputs Open	V _{CC}		3.5	10	mA
		EN, EN* = 2.4 or 0.5, Inputs Open			3.7	11	mA
I _{CCZ}	No Load Supply Current, Receivers Disabled	EN = GND, EN* = V _{CC} , Inputs Open			3.5	10	mA

- (1) Current into device pins is defined as positive. Current out of device pins is defined as negative. All voltages are referenced to ground unless otherwise specified.
- (2) All typicals are given for: V_{CC} = +5.0V, T_A = +25°C.
- (3) Output short circuit current (I_{OS}) is specified as magnitude only, minus sign indicates direction only. Only one output should be shorted at a time, do not exceed maximum junction temperature specification.

Switching Characteristics

V_{CC} = +5.0V, T_A = +25°C⁽¹⁾⁽²⁾⁽³⁾

Symbol	Parameter	Conditions	Min	Typ	Max	Units
t _{PHLD}	Differential Propagation Delay High to Low	C _L = 5 pF, V _{ID} = 200 mV, See Figure 2 and Figure 3	1.5	3.40	5.0	ns
t _{PLHD}	Differential Propagation Delay Low to High		1.5	3.48	5.0	ns
t _{SKD}	Differential Skew t _{PHLD} - t _{PLHD}		0	80	600	ps
t _{SK1}	Channel-to-Channel Skew ⁽⁴⁾		0	0.6	1.0	ns
t _{TLH}	Rise Time			0.5	2.0	ns
t _{THL}	Fall Time			0.5	2.0	ns
t _{PHZ}	Disable Time High to Z	R _L = 2 kΩ, C _L = 10 pF, See Figure 4 and Figure 5		10	15	ns
t _{PLZ}	Disable Time Low to Z			10	15	ns
t _{PZH}	Enable Time Z to High			4	10	ns
t _{PZL}	Enable Time Z to Low			4	10	ns

- (1) All typicals are given for: V_{CC} = +5.0V, T_A = +25°C.
- (2) Generator waveform for all tests unless otherwise specified: f = 1 MHz, Z_O = 50Ω, t_r and t_f (0%–100%) ≤ 1 ns for R_{IN} and t_r and t_f ≤ 6 ns for EN or EN*.
- (3) C_L includes probe and jig capacitance.
- (4) Channel-to-Channel Skew is defined as the difference between the propagation delay of one channel and that of the others on the same chip with an event on the inputs.

Switching Characteristics

$V_{CC} = +5.0V \pm 10\%$, $T_A = -40^\circ C$ to $+85^\circ C^{(1)(2)(3)}$

Symbol	Parameter	Conditions	Min	Typ	Max	Units
t_{PHLD}	Differential Propagation Delay High to Low	$C_L = 5\text{ pF}$, $V_{ID} = 200\text{ mV}$, See Figure 2 and Figure 3	1.0	3.40	6.0	ns
t_{PLHD}	Differential Propagation Delay Low to High		1.0	3.48	6.0	ns
t_{SKD}	Differential Skew $ t_{PHLD} - t_{PLHD} $		0	0.08	1.2	ns
t_{SK1}	Channel-to-Channel Skew ⁽⁴⁾		0	0.6	1.5	ns
t_{SK2}	Chip to Chip Skew ⁽⁵⁾				5.0	ns
t_{TLH}	Rise Time	$R_L = 2\text{ k}\Omega$, $C_L = 10\text{ pF}$, See Figure 4 and Figure 5		0.5	2.5	ns
t_{THL}	Fall Time			0.5	2.5	ns
t_{PHZ}	Disable Time High to Z			10	20	ns
t_{PLZ}	Disable Time Low to Z			10	20	ns
t_{PZH}	Enable Time Z to High			4	15	ns
t_{PZL}	Enable Time Z to Low		4	15	ns	

- (1) All typicals are given for: $V_{CC} = +5.0V$, $T_A = +25^\circ C$.
- (2) Generator waveform for all tests unless otherwise specified: $f = 1\text{ MHz}$, $Z_O = 50\Omega$, t_r and t_f (0%–100%) $\leq 1\text{ ns}$ for R_{IN} and t_r and $t_f \leq 6\text{ ns}$ for EN or EN*.
- (3) C_L includes probe and jig capacitance.
- (4) Channel-to-Channel Skew is defined as the difference between the propagation delay of one channel and that of the others on the same chip with an event on the inputs.
- (5) Chip to Chip Skew is defined as the difference between the minimum and maximum specified differential propagation delays.

Parameter Measurement Information

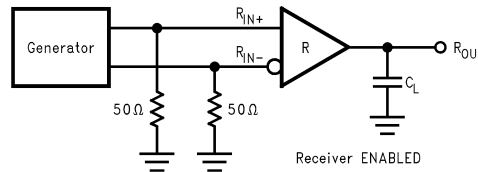

Figure 2. Receiver Propagation Delay and Transition Time Test Circuit

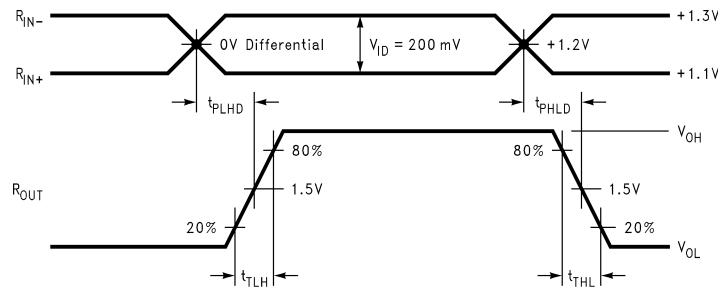
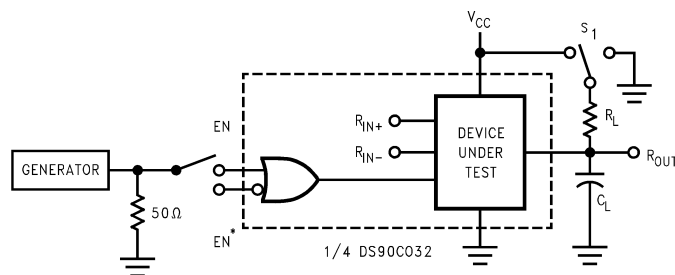

Figure 3. Receiver Propagation Delay and Transition Time Waveforms

Parameter Measurement Information (continued)



C_L includes load and test jig capacitance.
 $S_1 = V_{CC}$ for t_{PZL} and t_{PLZ} measurements.
 $S_1 = GND$ for t_{PZH} and t_{PHZ} measurements.

Figure 4. Receiver TRI-STATE Delay Test Circuit

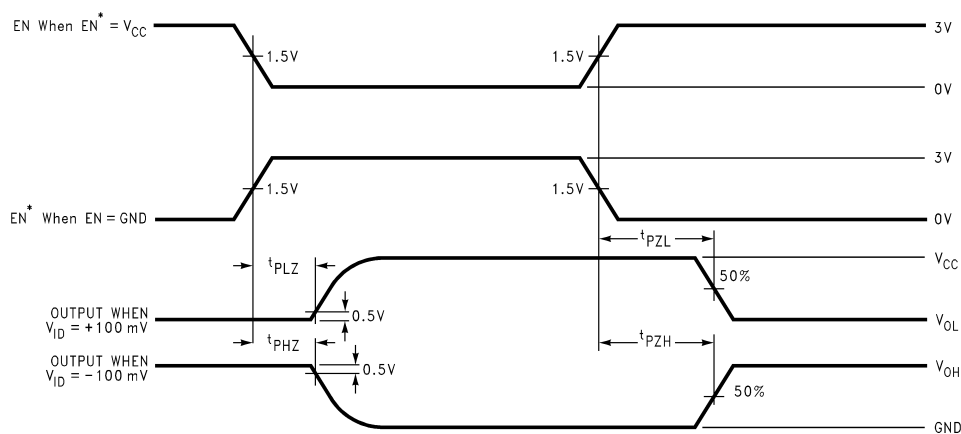

Figure 5. Receiver TRI-STATE Delay Waveforms

Typical Application

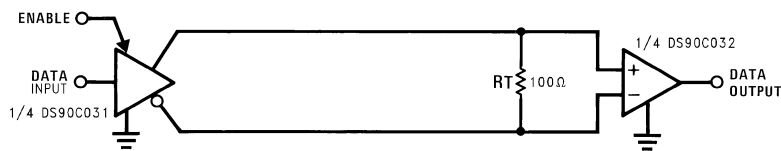

Figure 6. Point-to-Point Application

APPLICATIONS INFORMATION

LVDS drivers and receivers are intended to be primarily used in an uncomplicated point-to-point configuration as is shown in [Figure 6](#). This configuration provides a clean signaling environment for the quick edge rates of the drivers. The receiver is connected to the driver through a balanced media which may be a standard twisted pair cable, a parallel pair cable, or simply PCB traces. Typically the characteristic impedance of the media is in the range of 100Ω. A termination resistor of 100Ω should be selected to match the media, and is located as close to the receiver input pins as possible. The termination resistor converts the current sourced by the driver into a voltage that is detected by the receiver. Other configurations are possible such as a multi-receiver configuration, but the effects of a mid-stream connector(s), cable stub(s), and other impedance discontinuities as well as ground shifting, noise margin limits, and total termination loading must be taken into account.

The DS90C032B differential line receiver is capable of detecting signals as low as 100 mV, over a ±1V common-mode range centered around +1.2V. This is related to the driver offset voltage which is typically +1.2V. The driven signal is centered around this voltage and may shift ±1V around this center point. The ±1V shifting may be the result of a ground potential difference between the driver's ground reference and the receiver's ground reference, the common-mode effects of coupled noise, or a combination of the two. Both receiver input pins should honor their specified operating input voltage range of 0V to +2.4V (measured from each pin to ground), exceeding these limits may turn on the ESD protection circuitry which will clamp the bus voltages.

RECEIVER FAILSAFE

The LVDS receiver is a high gain, high speed device that amplifies a small differential signal (20mV) to CMOS logic levels. Due to the high gain and tight threshold of the receiver, care should be taken to prevent noise from appearing as a valid signal.

The receiver's internal failsafe circuitry is designed to source/sink a small amount of current, providing failsafe protection (a stable known state of HIGH output voltage) for floating and terminated (100Ω) receiver inputs in low noise environment (differential noise < 10mV).

1. Open Input Pins.

The DS90C032B is a quad receiver device, and if an application requires only 1, 2, or 3 receivers, the unused channel(s) inputs should be left OPEN. Do not tie unused receiver inputs to ground or any other voltages. The input is biased by internal high value pull up and pull down resistors to set the output to a HIGH state. This internal circuitry will ensure a HIGH, stable output state for open inputs.

2. Terminated Input. The DS90C032B requires external failsafe biasing for terminated input failsafe.

Terminated input failsafe is the case of a receiver that has a 100Ω termination across its inputs and the driver is in the following situations. Unplugged from the bus, or the driver output is in TRI-STATE or in power-off condition. The use of external biasing resistors provide a small bias to set the differential input voltage while the line is un-driven, and therefore the receiver output will be in HIGH state. If the driver is removed from the bus but the cable is still present and floating, the unplugged cable can become a floating antenna that can pick up noise. The LVDS receiver is designed to detect very small amplitude and width signals and recover them to standard logic levels. Thus, if the cable picks up more than 10mV of differential noise, the receiver may respond. To insure that any noise is seen as common-mode and not differential, a balanced interconnect and twisted pair cables is recommended, as they help to ensure that noise is coupled common to both lines and rejected by the receivers.

3. Operation in environment with greater than 10mV differential noise.

TI recommends external failsafe biasing on its LVDS receivers for a number of system level and signal quality reasons. First, only an application that requires failsafe biasing needs to employ it. Second, the amount of failsafe biasing is now an application design parameter and can be custom tailored for the specific application. In applications in low noise environments, they may choose to use a very small bias if any. For applications with less balanced interconnects and/or in high noise environments they may choose to boost failsafe further. TI's "LVDS Owner's Manual provides detailed calculations for selecting the proper failsafe biasing resistors. Third, the common-mode voltage is biased by the resistors during the un-driven state. This is selected to be close to the nominal driver offset voltage (V_{OS}). Thus when switching between driven and un-driven states, the common-mode modulation on the bus is held to a minimum.

For additional Failsafe Biasing information, please refer to Application Note [AN-1194](#) for more detail.

The footprint of the DS90C032B is the same as the industry standard 26LS32 Quad Differential (RS-422) Receiver.

For additional LVDS application information, please refer to TI's LVDS Owner's Manual available through TI's website <http://www.ti.com/lvds>

Pin Descriptions

Pin No.	Name	Description
2, 6, 10, 14	R _{IN+}	Non-inverting receiver input pin
1, 7, 9, 15	R _{IN-}	Inverting receiver input pin
3, 5, 11, 13	R _{OUT}	Receiver output pin
4	EN	Active high enable pin, OR-ed with EN*
12	EN*	Active low enable pin, OR-ed with EN
16	V _{CC}	Power supply pin, +5V ± 10%
8	GND	Ground pin

Typical Performance Characteristics

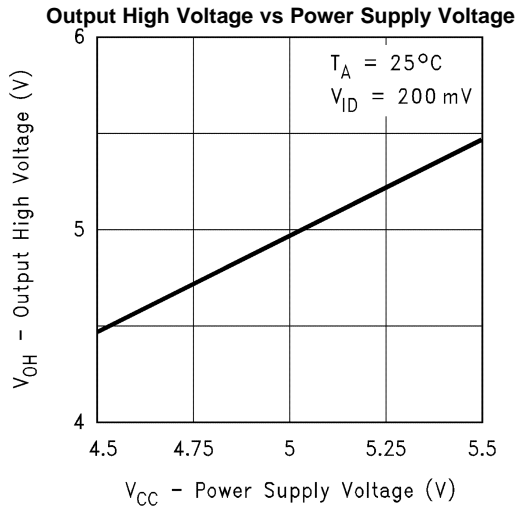

Figure 7.

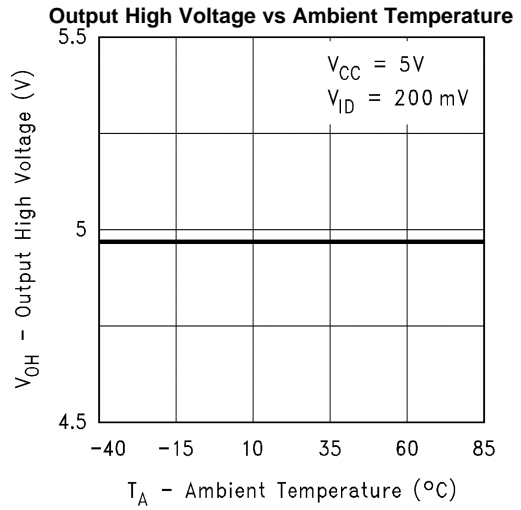

Figure 8.

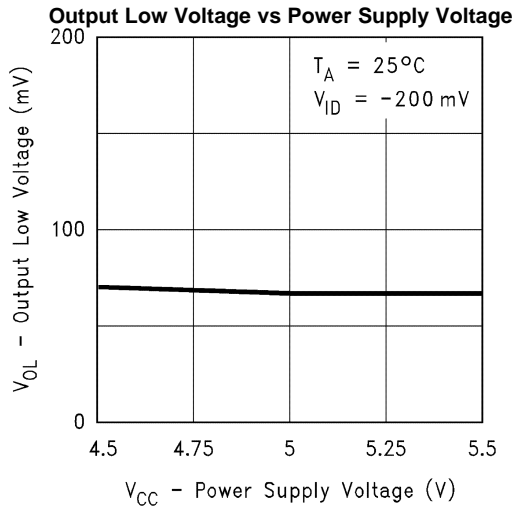

Figure 9.

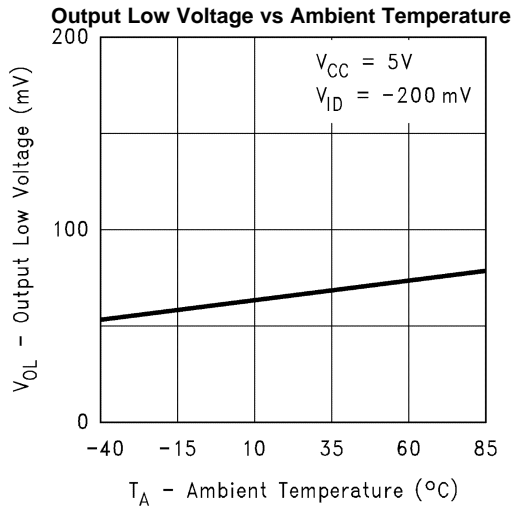

Figure 10.

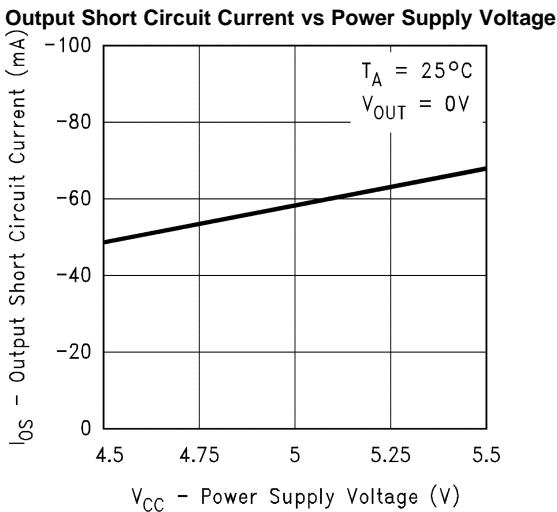

Figure 11.

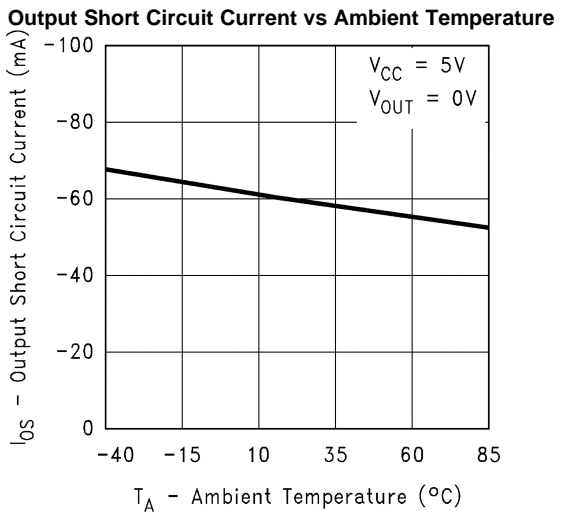

Figure 12.

Typical Performance Characteristics (continued)

Differential Propagation Delay vs Power Supply Voltage

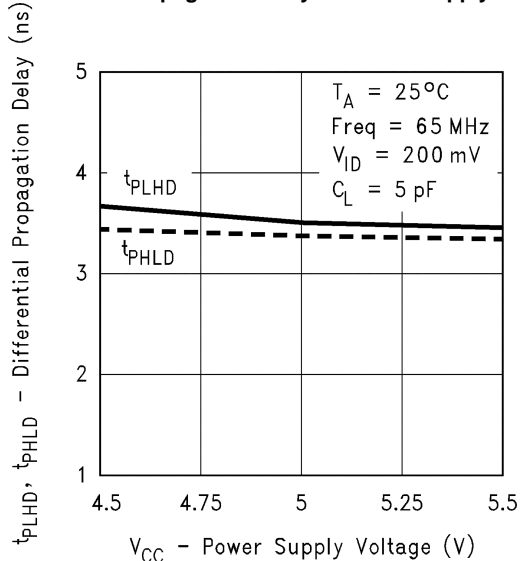

Figure 13.

Differential Propagation Delay vs Ambient Temperature

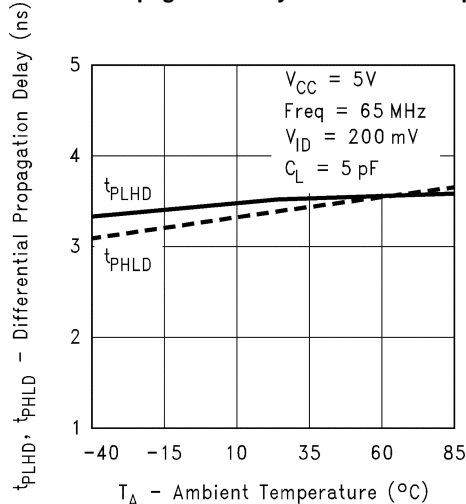

Figure 14.

Differential Skew vs Power Supply Voltage

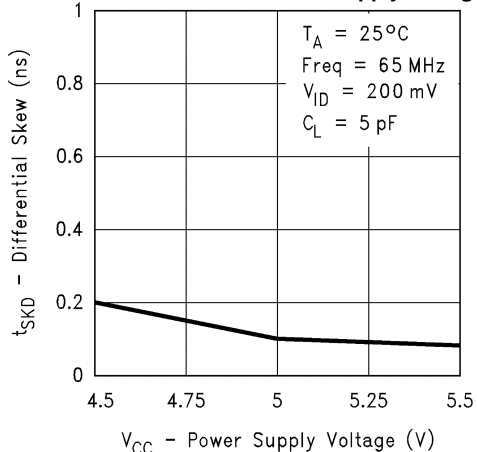

Figure 15.

Differential Skew vs Ambient Temperature

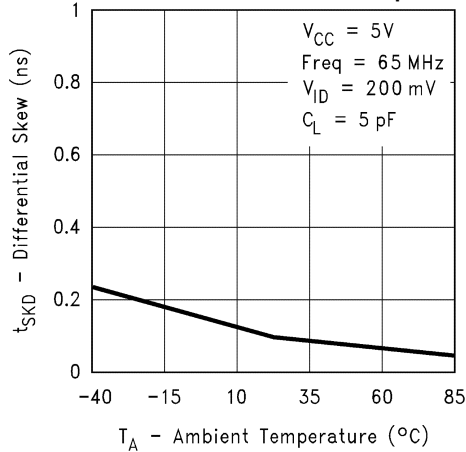

Figure 16.

Transition Time vs Power Supply Voltage

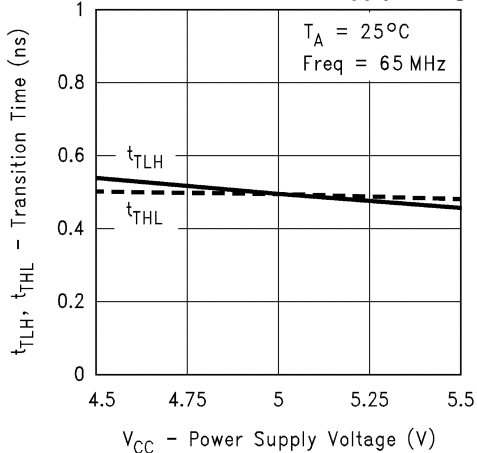

Figure 17.

Transition Time vs Ambient Temperature

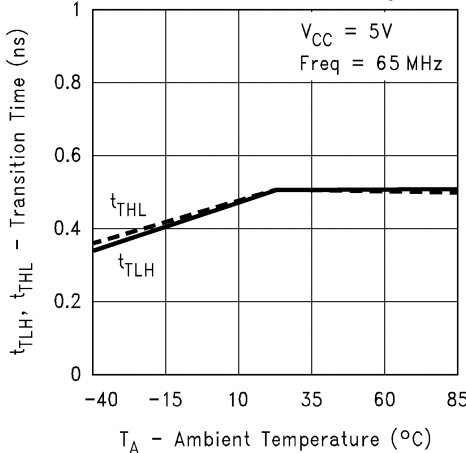



Figure 18.

REVISION HISTORY

Changes from Revision B (April 2013) to Revision C	Page
• Changed layout of National Data Sheet to TI format	9

PACKAGING INFORMATION

Orderable Device	Status (1)	Package Type	Package Drawing	Pins	Package Qty	Eco Plan (2)	Lead/Ball Finish (6)	MSL Peak Temp (3)	Op Temp (°C)	Device Marking (4/5)	Samples
DS90C032BTM	NRND	SOIC	D	16	48	TBD	Call TI	Call TI	-40 to 85	DS90C032BTM	
DS90C032BTM/NOPB	ACTIVE	SOIC	D	16	48	Green (RoHS & no Sb/Br)	CU SN Call TI	Level-1-260C-UNLIM	-40 to 85	DS90C032BTM	
DS90C032BTMX	NRND	SOIC	D	16	2500	TBD	Call TI	Call TI	-40 to 85	DS90C032BTM	
DS90C032BTMX/NOPB	ACTIVE	SOIC	D	16	2500	Green (RoHS & no Sb/Br)	CU SN Call TI	Level-1-260C-UNLIM	-40 to 85	DS90C032BTM	

(1) The marketing status values are defined as follows:

ACTIVE: Product device recommended for new designs.

LIFEBUY: TI has announced that the device will be discontinued, and a lifetime-buy period is in effect.

NRND: Not recommended for new designs. Device is in production to support existing customers, but TI does not recommend using this part in a new design.

PREVIEW: Device has been announced but is not in production. Samples may or may not be available.

OBSELETE: TI has discontinued the production of the device.

(2) Eco Plan - The planned eco-friendly classification: Pb-Free (RoHS), Pb-Free (RoHS Exempt), or Green (RoHS & no Sb/Br) - please check <http://www.ti.com/productcontent> for the latest availability information and additional product content details.

TBD: The Pb-Free/Green conversion plan has not been defined.

Pb-Free (RoHS): TI's terms "Lead-Free" or "Pb-Free" mean semiconductor products that are compatible with the current RoHS requirements for all 6 substances, including the requirement that lead not exceed 0.1% by weight in homogeneous materials. Where designed to be soldered at high temperatures, TI Pb-Free products are suitable for use in specified lead-free processes.

Pb-Free (RoHS Exempt): This component has a RoHS exemption for either 1) lead-based flip-chip solder bumps used between the die and package, or 2) lead-based die adhesive used between the die and leadframe. The component is otherwise considered Pb-Free (RoHS compatible) as defined above.

Green (RoHS & no Sb/Br): TI defines "Green" to mean Pb-Free (RoHS compatible), and free of Bromine (Br) and Antimony (Sb) based flame retardants (Br or Sb do not exceed 0.1% by weight in homogeneous material)

(3) MSL, Peak Temp. - The Moisture Sensitivity Level rating according to the JEDEC industry standard classifications, and peak solder temperature.

(4) There may be additional marking, which relates to the logo, the lot trace code information, or the environmental category on the device.

(5) Multiple Device Markings will be inside parentheses. Only one Device Marking contained in parentheses and separated by a "~" will appear on a device. If a line is indented then it is a continuation of the previous line and the two combined represent the entire Device Marking for that device.

(6) Lead/Ball Finish - Orderable Devices may have multiple material finish options. Finish options are separated by a vertical ruled line. Lead/Ball Finish values may wrap to two lines if the finish value exceeds the maximum column width.

Important Information and Disclaimer:The information provided on this page represents TI's knowledge and belief as of the date that it is provided. TI bases its knowledge and belief on information provided by third parties, and makes no representation or warranty as to the accuracy of such information. Efforts are underway to better integrate information from third parties. TI has taken and

continues to take reasonable steps to provide representative and accurate information but may not have conducted destructive testing or chemical analysis on incoming materials and chemicals. TI and TI suppliers consider certain information to be proprietary, and thus CAS numbers and other limited information may not be available for release.

In no event shall TI's liability arising out of such information exceed the total purchase price of the TI part(s) at issue in this document sold by TI to Customer on an annual basis.

TAPE AND REEL INFORMATION



QUADRANT ASSIGNMENTS FOR PIN 1 ORIENTATION IN TAPE



*All dimensions are nominal

Device	Package Type	Package Drawing	Pins	SPQ	Reel Diameter (mm)	Reel Width W1 (mm)	A0 (mm)	B0 (mm)	K0 (mm)	P1 (mm)	W (mm)	Pin1 Quadrant
DS90C032BTMX	SOIC	D	16	2500	330.0	16.4	6.5	10.3	2.3	8.0	16.0	Q1
DS90C032BTMX/NOPB	SOIC	D	16	2500	330.0	16.4	6.5	10.3	2.3	8.0	16.0	Q1

TAPE AND REEL BOX DIMENSIONS

*All dimensions are nominal

Device	Package Type	Package Drawing	Pins	SPQ	Length (mm)	Width (mm)	Height (mm)
DS90C032BTMX	SOIC	D	16	2500	367.0	367.0	35.0
DS90C032BTMX/NOPB	SOIC	D	16	2500	367.0	367.0	35.0

D (R-PDSO-G16)

PLASTIC SMALL OUTLINE



- NOTES:
- A. All linear dimensions are in inches (millimeters).
 - B. This drawing is subject to change without notice.
 - C. Body length does not include mold flash, protrusions, or gate burrs. Mold flash, protrusions, or gate burrs shall not exceed 0.006 (0,15) each side.
 - D. Body width does not include interlead flash. Interlead flash shall not exceed 0.017 (0,43) each side.
 - E. Reference JEDEC MS-012 variation AC.

IMPORTANT NOTICE

Texas Instruments Incorporated and its subsidiaries (TI) reserve the right to make corrections, enhancements, improvements and other changes to its semiconductor products and services per JESD46, latest issue, and to discontinue any product or service per JESD48, latest issue. Buyers should obtain the latest relevant information before placing orders and should verify that such information is current and complete. All semiconductor products (also referred to herein as "components") are sold subject to TI's terms and conditions of sale supplied at the time of order acknowledgment.

TI warrants performance of its components to the specifications applicable at the time of sale, in accordance with the warranty in TI's terms and conditions of sale of semiconductor products. Testing and other quality control techniques are used to the extent TI deems necessary to support this warranty. Except where mandated by applicable law, testing of all parameters of each component is not necessarily performed.

TI assumes no liability for applications assistance or the design of Buyers' products. Buyers are responsible for their products and applications using TI components. To minimize the risks associated with Buyers' products and applications, Buyers should provide adequate design and operating safeguards.

TI does not warrant or represent that any license, either express or implied, is granted under any patent right, copyright, mask work right, or other intellectual property right relating to any combination, machine, or process in which TI components or services are used. Information published by TI regarding third-party products or services does not constitute a license to use such products or services or a warranty or endorsement thereof. Use of such information may require a license from a third party under the patents or other intellectual property of the third party, or a license from TI under the patents or other intellectual property of TI.

Reproduction of significant portions of TI information in TI data books or data sheets is permissible only if reproduction is without alteration and is accompanied by all associated warranties, conditions, limitations, and notices. TI is not responsible or liable for such altered documentation. Information of third parties may be subject to additional restrictions.

Resale of TI components or services with statements different from or beyond the parameters stated by TI for that component or service voids all express and any implied warranties for the associated TI component or service and is an unfair and deceptive business practice. TI is not responsible or liable for any such statements.

Buyer acknowledges and agrees that it is solely responsible for compliance with all legal, regulatory and safety-related requirements concerning its products, and any use of TI components in its applications, notwithstanding any applications-related information or support that may be provided by TI. Buyer represents and agrees that it has all the necessary expertise to create and implement safeguards which anticipate dangerous consequences of failures, monitor failures and their consequences, lessen the likelihood of failures that might cause harm and take appropriate remedial actions. Buyer will fully indemnify TI and its representatives against any damages arising out of the use of any TI components in safety-critical applications.

In some cases, TI components may be promoted specifically to facilitate safety-related applications. With such components, TI's goal is to help enable customers to design and create their own end-product solutions that meet applicable functional safety standards and requirements. Nonetheless, such components are subject to these terms.

No TI components are authorized for use in FDA Class III (or similar life-critical medical equipment) unless authorized officers of the parties have executed a special agreement specifically governing such use.

Only those TI components which TI has specifically designated as military grade or "enhanced plastic" are designed and intended for use in military/aerospace applications or environments. Buyer acknowledges and agrees that any military or aerospace use of TI components which have **not** been so designated is solely at the Buyer's risk, and that Buyer is solely responsible for compliance with all legal and regulatory requirements in connection with such use.

TI has specifically designated certain components as meeting ISO/TS16949 requirements, mainly for automotive use. In any case of use of non-designated products, TI will not be responsible for any failure to meet ISO/TS16949.

Products

Audio	www.ti.com/audio
Amplifiers	amplifier.ti.com
Data Converters	dataconverter.ti.com
DLP® Products	www.dlp.com
DSP	dsp.ti.com
Clocks and Timers	www.ti.com/clocks
Interface	interface.ti.com
Logic	logic.ti.com
Power Mgmt	power.ti.com
Microcontrollers	microcontroller.ti.com
RFID	www.ti-rfid.com
OMAP Applications Processors	www.ti.com/omap
Wireless Connectivity	www.ti.com/wirelessconnectivity

Applications

Automotive and Transportation	www.ti.com/automotive
Communications and Telecom	www.ti.com/communications
Computers and Peripherals	www.ti.com/computers
Consumer Electronics	www.ti.com/consumer-apps
Energy and Lighting	www.ti.com/energy
Industrial	www.ti.com/industrial
Medical	www.ti.com/medical
Security	www.ti.com/security
Space, Avionics and Defense	www.ti.com/space-avionics-defense
Video and Imaging	www.ti.com/video

TI E2E Community

e2e.ti.com

Looking for pricing, stock, or lifecycle information?

Click below to explore more details on WIN SOURCE:

 [View DS90C032BTMX/NOPB on WIN SOURCE](#)

 [Texas Instruments](#) Information

Optimize Your Supply Chain with WIN SOURCE Solutions

-  Global Sourcing Solution
-  Obsolete Management
-  Cost Control Management
-  Shortage Management
-  Alternative Solution
-  Excess Inventory Management