



**THE DATASHEET OF
TP11SH8AVBE**



TP Series

Tiny Pushbutton Switches

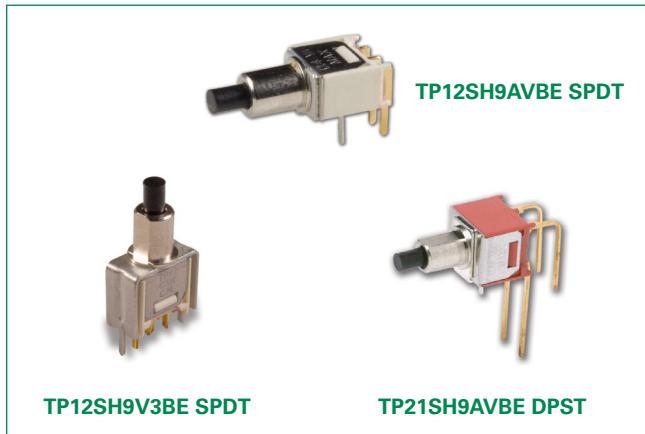

Agency Approvals

Agency	Agency File Number
	E42363

Specifications

Contact Rating	B contact material: 0.4 VA max. @ 20 V AC or DC max. Q contact material: 1 amp @ 120 V AC or 28 V DC. See page 8 for additional ratings.
Electrical Life	TP11, TP21 models: 60,000 make-and-break cycles at full load. TP12 models: 30,000 cycles.
Contact Resistance	Below 20 mΩ 15 typ. initial @ 2-4 V DC, 100 mA, for both silver and gold plated contacts.
Insulation Resistance	10 ⁹ Ω 15 min.
Dielectric Strength	1000 Vrms min. @ sea level.
Operating Temperature	-30°C to 85°C
Solderability	Per MIL-STD-202F method 208D, or EIA RS-186E method 9 (1 hour steam aging).

Notes:

Any models supplied with Q, B, P, S, R or G contact material are RoHS compliant. Specifications and materials listed above are for switches with standard options. For information on specific and custom switches, consult Customer Service Center.

Description

TP series of tiny pushbutton switches are used most often in telecommunications, networking and instrumentation applications. The TP switches are well-known for their subminiature size and ability to switch at 1 AMP. Snap-in front panel mounting is available, as are vertical and right angle terminations – and their epoxy terminal seal is compatible with bottom wash cleaning.

Features & Benefits

- Sealed against solder & cleaning processes
- Through-hole and surface mount models
- Snap-fitting actuator accepts standard caps
- Tape & reel packaging available
- RoHS compliant models available

Applications

- Telecommunications and networking equipment
- Computers and peripherals
- Instrumentation and controls

Materials

Case	Glass filled nylon 4/6 or 6/6, flame retardant, heat stabilized or diallyl phthalate (DAP), (UL 94V-0).
Plunger	Thermoplastic polyester (UL 94V-0).
Cap & Frame	Nylon, black standard
Bushing	Brass, nickel plated.
Housing	Stainless steel
Switch Support	Brass, matte-tin plated.
End Contacts	B contact material: Copper alloy, with gold plate over nickel plate. Q contact material: Coin silver, silver plated. See page 8 for additional contact materials.
Center Contacts & All Terminals	B contact material: Copper alloy, with gold plate over nickel plate. Q contact material: Copper alloy, silver plated. See page 8 for additional contact materials.
Terminal Seal	Epoxy. Refer to soldering and cleaning in Technical Data Chapter
Hardware	Nut & Locking Ring: Brass nickel plated. Lockwasher: Steel, nickel plated.

TP Series

Tiny Pushbutton Switches



Ordering Number

To order, simply select desired option from each category and place in the appropriate box. Available options are shown and described on pages 2-10. For additional options not shown in catalog, consult Customer Service Center. All models have epoxy terminal seal and are compatible with all "bottom-wash" PCB cleaning methods.

X - X - X - X - X - X - X

<p>Switch Function</p> <p>TP11: SPST Off-Mom. TP12: SPDT On-Mom. TP21: DPST Off-Mom.</p> <p>Actuator or Bushing</p> <p>SH: .155" high plunger, threaded, .220" high bushing, flat SH8: .155" high plunger, unthreaded, .220" high bushing, round SH9: .155" high plunger, unthreaded, .220" high bushing, flat J81: Snap-in with frame LT: .215" high plunger, threaded, .310" high bushing, flat LT9: .215" high plunger, unthreaded, .310" high bushing, flat MS9: .130" high plunger, .020" high bushing, round</p>	<p>Terminations</p> <p>A: Right angle, PC Thru-hole C: PC Thru-hole Z: Solder lug AV: Vertical right angle, PC Thru-hole V3: Vertical mount, v-bracket W: Wire wrap</p>	<p>Frame Color</p> <p>2: Black None: Models with no frame</p> <p>Cap Color</p> <p>2: Black None: Models with no cap 1: White</p> <p>Seal</p> <p>E: Epoxy</p> <p>Contact Material</p> <p>B: Gold P: Gold, matte-tin Q: Silver G: Gold over silver R: Gold over silver, matte tin</p>
--	--	---

Switch Function

SPDT

No. Poles	Model Number	Switch Function		Connected Terminals		Schematic
		POS. 1	POS. 2	POS. 1	POS. 2	
		C&K marking on opposite side				
SP	TP11	OFF	MOM.	OPEN	1-3	
SP	TP12	ON	MOM.	2-1	2-3	

Dimensions inches (mm)

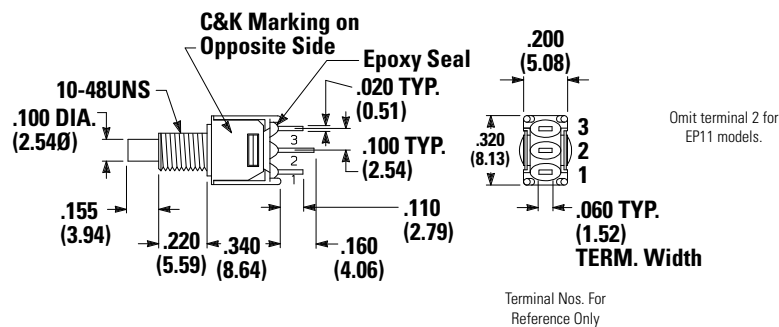

Part Number Shown: TP12SHZQE

TP Series

Tiny Pushbutton Switches



DPST

No. Poles	Mo. Poles	Switch Function		Connected Terminals		Schematic
		POS. 1	POS. 2	POS. 1	POS. 2	
		C&K marking on opposite side				
DP	TP21	OFF	MOM.	OPEN	1-3, 4-6	

Dimensions inches (mm)

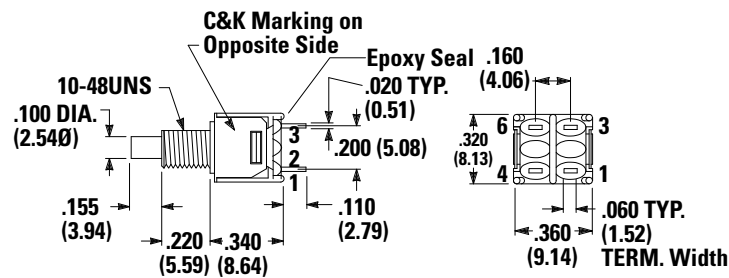

Note: Part Number Shown: TP21SHZQE

MOM. = Momentary All models C&K us with all options when ordered with G, Q or R contact material.

Terminal Nos. For Reference Only

Actuator Snap-in Front Mount

J81 Snap-in with Frame

Dimensions inches (mm)

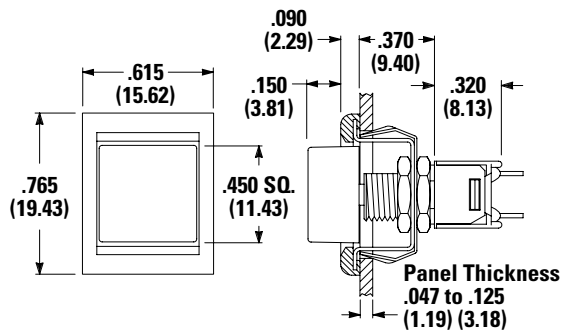

Option Code	Cap Color
2	Black
1	White

Option Code	Frame Color
2	Black
None	No Frame Color (J80 option)

Panel Mounting

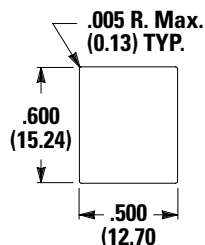

Notes:

Caps & Frames available separately, see page 8. Cap and Frame Finish: matte. Other colors available, consult Customer Service Center. Available with Z, C, or W terminations.

TP Series

Tiny Pushbutton Switches



Bushing

SH 0.155" High Plunger
0.220" High Bushing,
Threaded, Flat

Dimensions inches (mm)

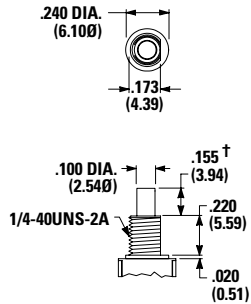

Notes:
 Standard with Z, C, W terminations.

SH8 0.155" High Plunger
0.220" High Bushing,
Unthreaded

Dimensions inches (mm)

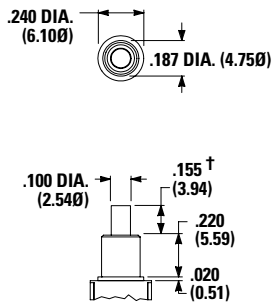

Notes:
 Standard with A, AV, V3 terminations.
 † Subtract .016 (0.41) for models with A, AV or V3 terminations.
 Caps available for plunger options, see page 8.

SH9 0.155" High Plunger
0.220" High Bushing,
Unthreaded, Flat

Dimensions inches (mm)

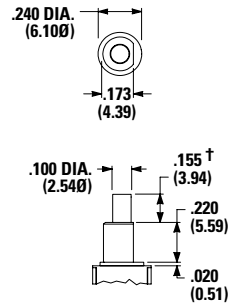

LT 0.21517" High Plunger, 0.310" High Bushing, Threaded
LT9 0.21517" High Plunger, 0.310" High Bushing, Unthreaded
Dimensions inches (mm)

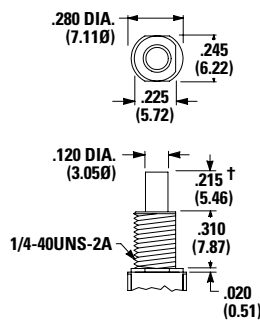

MS9 0.130" High Plunger
Dimensions inches (mm)

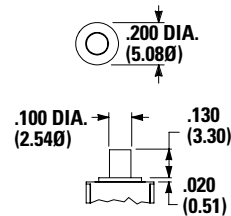

Note: Not available with Z terminations.

Panel Mounting

10-48 Bushing
Dimensions inches (mm)

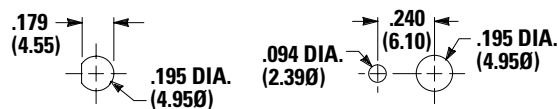

Without locking ring

With standard locking ring

1/4 In. Bushing
Dimensions inches (mm)

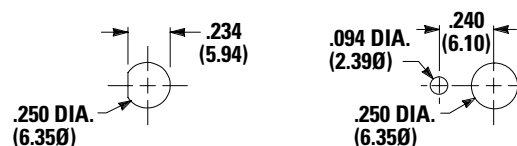

Without locking ring

With standard locking ring

Notes:
 One mounting nut, locking ring and lockwasher supplied standard with 10-48 threaded bushings (two nuts with 1/4-40 bushings). Optional mounting nut and locking ring styles and finishes available separately, see section "Technical Data and Additional Hardware".

TP Series

Tiny Pushbutton Switches



Terminations

C PCThru-hole
Dimensions inches (mm)

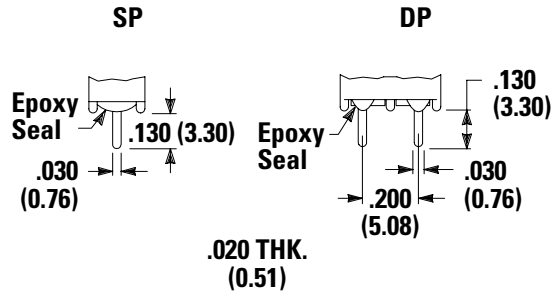

Z Solder Lug
Dimensions inches (mm)

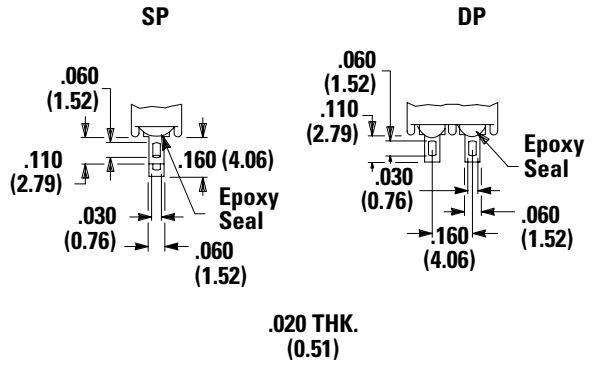

Note: Not available with MS9 bushing or P or R contact material.

PC Mounting

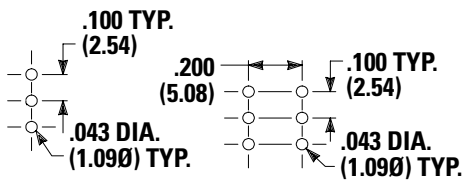

Omit center holes
for TP11 models

W Wire Wrap
Dimensions inches (mm)

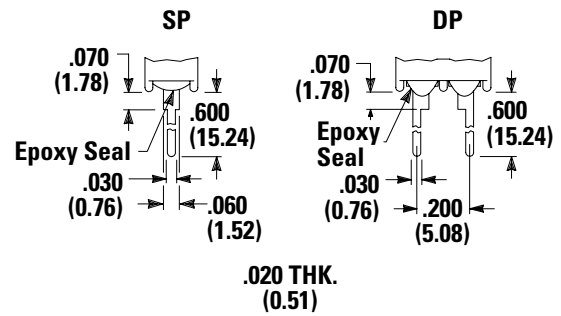

A Right Angle, PCThru-hole
TP12SH9ABE SPDT

Dimensions inches (mm)

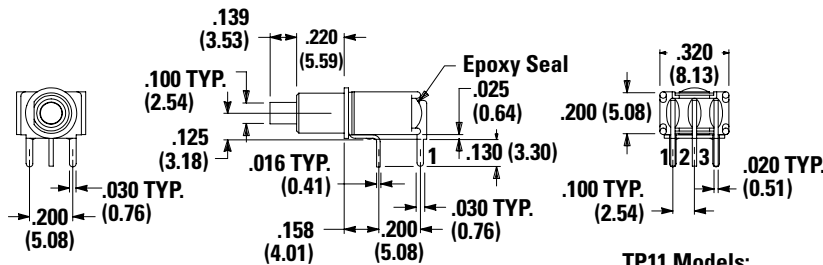

TP11 Models:
omit terminal 2.

PC Mounting

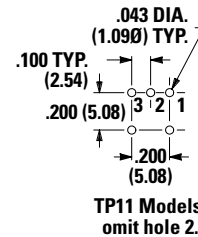

TP11 Models:
omit hole 2.

TP Series

Tiny Pushbutton Switches



A Right Angle, PC Thru-hole TP21SH9ABE DPST

Dimensions inches (mm)

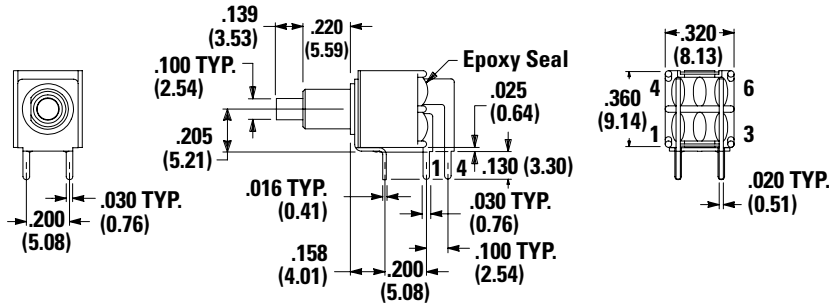

PC Mounting

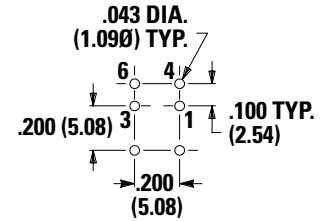

AV Vertical Right Angle, PC Thru-hole TP12SH9AVBE SPDT

Dimensions inches (mm)

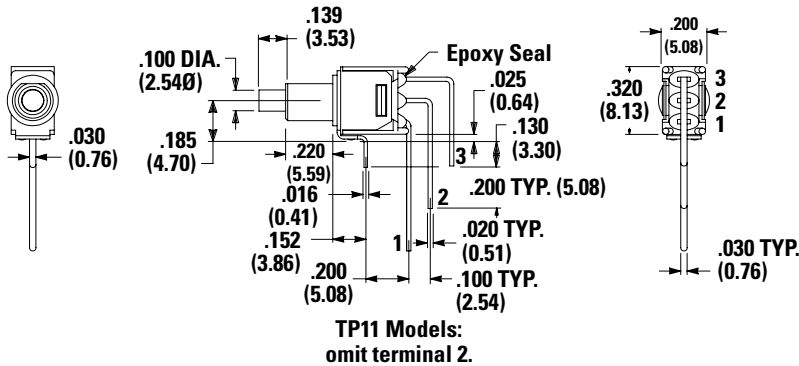

PC Mounting

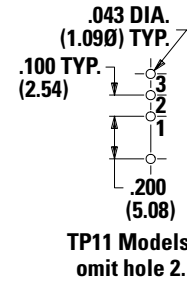

Notes:
Terminal bend radii and lead-in manufacturing option.

AV Vertical Right Angle, PC Thru-hole TP21SH9AVBE DPST

Dimensions inches (mm)

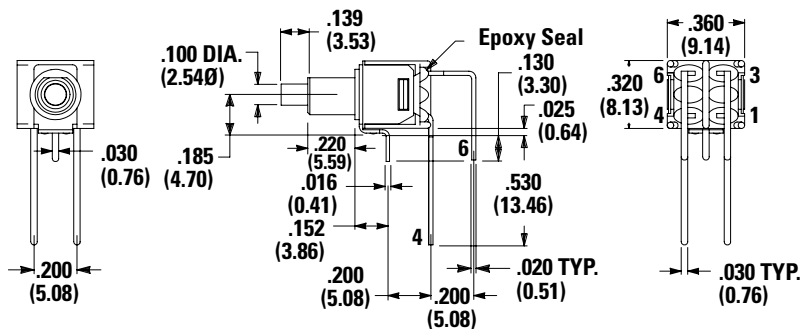

PC Mounting

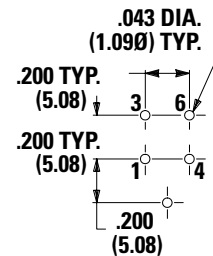

Note: Terminal bend radii and lead-in manufacturing option.

TP Series

Tiny Pushbutton Switches



V3 Vertical Mount, V-Bracket TP12SH9V3BE SPDT

Dimensions inches (mm)

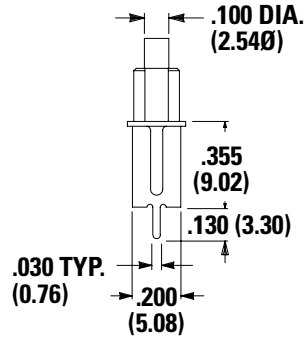
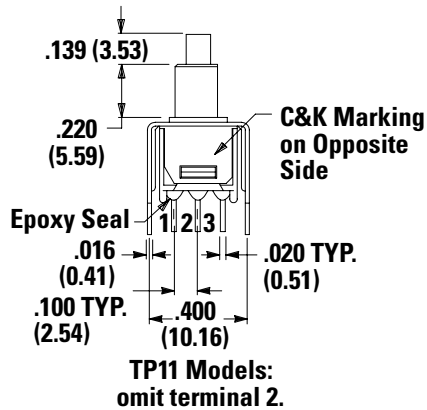

PC Mounting

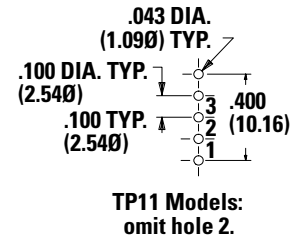

V3 Vertical Mount, V-Bracket TP21SH9V3BE DPST

Dimensions inches (mm)

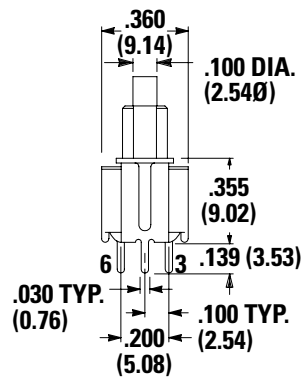
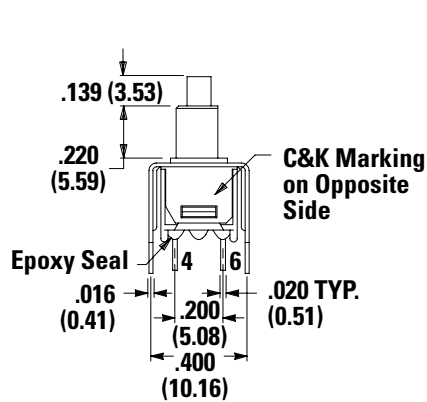

PC Mounting

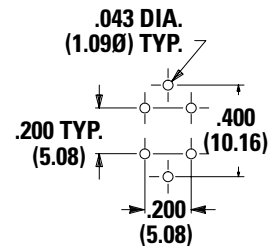

TP Series

Tiny Pushbutton Switches



Contact Material

Option Code	Contact Material	Terminal Plating	Ratings	
B	Gold ¹	Gold ¹	Low Level/Dry Circuit	0.4 VA Max. @ 20 V AC or DC Max.
P		Matte-Tin ⁶		
Q	Silver ^{4,5}	Silver ⁵	Power	1 AMP @ 120 V AC or 28 V DC
G	Gold over Silver ^{2,3}	Gold ³	Low Level/Dry Circuit or Power	0.4 VA Max @ 20 V AC or DC Max. or 28 V DC
R		Matte-Tin ⁶		

Notes:

See Technical Data section of this catalog for RoHS compliant and compatible definitions and specifications.

1. Contacts & Terminals: Copper alloy, with gold plate over nickel plate.

2. End Contacts: Coin silver, with gold plate over nickel plate.

3. Center Contacts & All Terminals: Copper alloy, with gold plate over nickel plate.

4. End Contacts: Coin silver, silver plated.

5. Center Contact & All Terminals: Copper alloy, silver plated.

6. Terminals: Copper alloy, with matte tin over nickel plate.

Any models supplied with P, R, Q, B or G contact material are RoHS compliant. All models  with all options when ordered with R, G, or Q contact material. B contact material standard with A, AV, V3 & W terminations. Q contact material standard with C & Z terminations. P, R contact materials not available with Z terminations.

Seal

E Epoxy Seal

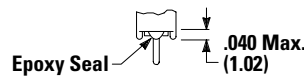

Available Hardware

Cap, 0.100" DIA. Plungers

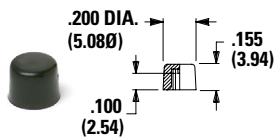

PART NO.
508101000 WHITE
508102000 BLACK
Material: Nylon
Finish: Gloss

Cap, 0.100" DIA. Plungers (Recommended for S9 plunger)

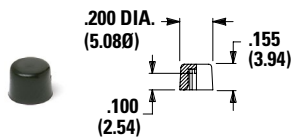

PART NO.
538701000 WHITE
538702000 BLACK
Material: Nylon
Finish: Gloss

Cap, 0.100" DIA. Plungers

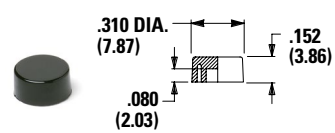

PART NO.
465801000 WHITE
465802000 BLACK
Material: Nylon
Finish: Gloss

TP Series

Tiny Pushbutton Switches



Cap, 0.120" DIA.
Plungers

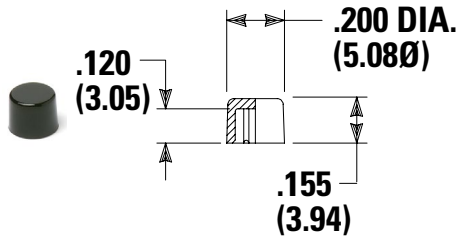

PART NO.
708901000 WHITE
708902000 BLACK
Material: Nylon
Finish: Gloss

Cap, 0.120" DIA.
Plungers

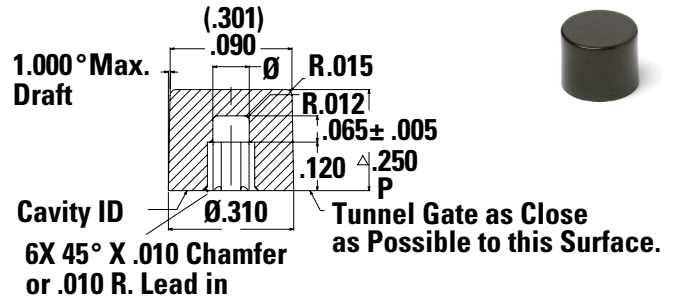

PART NO.
891D01000 WHITE
891D02000 BLACK
Material: Nylon
Finish: Gloss

Cap, J81 option only

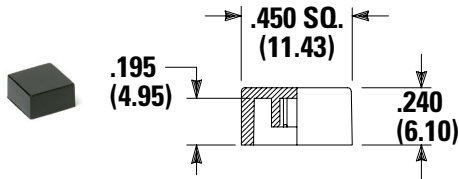

PART NO.
484601000 WHITE
484602000 BLACK
Material: Nylon
Finish: Gloss

PART NO.
798201000 WHITE
798202263 BLACK
Material: Nylon
Finish: Matte

Note: Additional nuts, locking rings and lockwashers available separately, see section "Technical Data and Additional Hardware". Other cap colors available, consult Customer Service Center.

TP Series

Tiny Pushbutton Switches



Available Hardware

Frames snap into panel opening and are independent from switch mounting. Accurate positioning of the PC mounted switch relative to the panel opening is necessary to provide proper clearance between actuator and frame. Available in two basic styles and four panel thicknesses .047-.125 in. Material: Nylon. Finish: Matte.

Typical Application

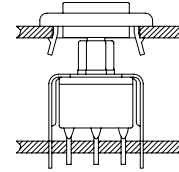

Dimensions



Panel Mounting

For Part Numbers
432502263. 432602263

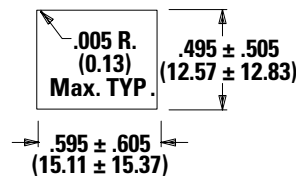

0.090" (2.29) PANEL THK.
PART NO. 432702263

For Part Numbers
432702263. 432802263

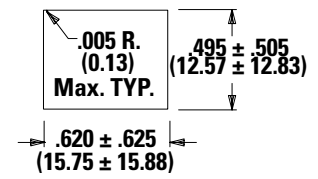

0.125" (3.18) PANEL THK.
PART NO. 432802263
BLACK

Above frames (part nos. 432XXXXXX) are also available with insert which accepts LED for indicator light assembly. Order insert separately from frame. Blank insert panel (without hole for LED) also available. LED not included.

Panel Inserts

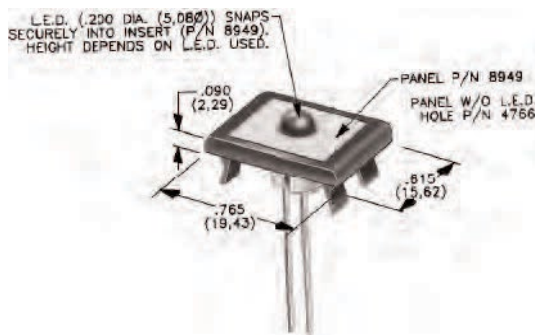



Panel Insert with Hole for LED **Part No.** 894902000

Blank Panel Insert without Hole for LED **Part No.** 476602000 Black

Disclaimer Notice - Information furnished is believed to be accurate and reliable. However, users should independently evaluate the suitability of and test each product selected for their own applications. Littelfuse products are not designed for, and may not be used in, all applications. Read complete Disclaimer Notice at <http://www.littelfuse.com/disclaimer-electronics>.

Looking for pricing, stock, or lifecycle information?

Click below to explore more details on WIN SOURCE:

-  [View TP11SH8AVBE](#) on WIN SOURCE
-  [C&K Components](#) Information

Optimize Your Supply Chain with WIN SOURCE Solutions

-  Global Sourcing Solution
-  Obsolete Management
-  Cost Control Management
-  Shortage Management
-  Alternative Solution
-  Excess Inventory Management