

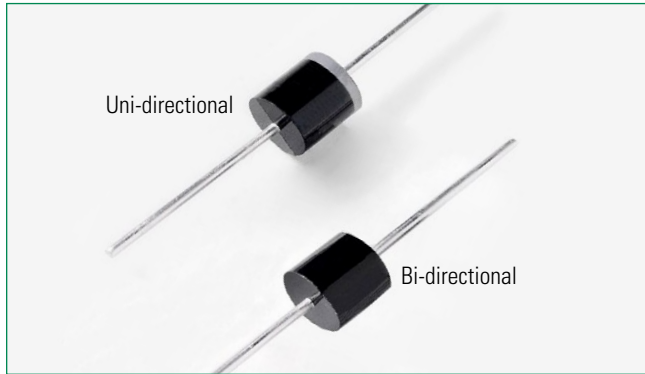

**THE DATASHEET OF
15KPA48A**



15KPA Series



Agency Approvals

| Agency | Agency File Number |
|---|--------------------|
|  | E230531 |

Maximum Ratings and Thermal Characteristics (T_A = 25°C unless otherwise noted)

| Parameter | Symbol | Value | Unit |
|--|-----------------------------------|------------|------|
| Peak Pulse Power Dissipation by 10/1000µs Test Waveform (Fig.2)(Note 1) | P _{PPM} | 15 | kW |
| Steady State Power Dissipation on Infinite Heat Sink at T _L = 75°C | P _D | 8.0 | W |
| Peak Forward Surge Current, 8.3ms Single Half Sine Wave Unidirectional Only (Note 2) | I _{FSM} | 400 | A |
| Operating Junction and Storage Temperature Range | T _J , T _{STG} | -55 to 175 | °C |
| Typical Thermal Resistance Junction to Lead | R _{θJL} | 8.0 | °C/W |
| Typical Thermal Resistance Junction to Ambient | R _{θJA} | 40 | °C/W |

Notes:

1. Non-repetitive current pulse, per Fig. 4 and derated above T_J (initial) = 25°C per Fig. 3.
2. Measured on 8.3ms single half sine wave or equivalent square wave, duty cycle=4 per minute maximum.

Functional Diagram

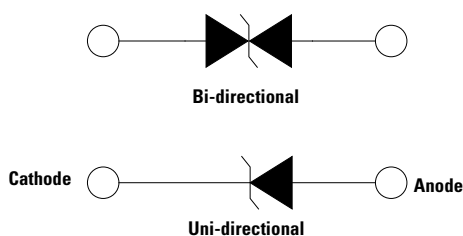

Descriptions

The 15KPA Series is designed specifically to protect sensitive electronic equipment from voltage transients induced by lightning and other transient voltage events.

Features

- Glass passivated chip junction in P600 package
- 15kW peak pulse capability at 10/1000µs waveform, repetition rate (duty cycles):0.01 %
- Fast response time: typically less than 1.0ps from 0 Volts to BV min
- Excellent clamping capability
- Typical failure mode is short from over-specified voltage or current
- Whisker test is conducted based on JEDEC JESD201A per its table 4a and 4c
- IEC 61000-4-2 ESD 30kV(Air), 30kV (Contact)
- ESD protection of data lines in accordance with IEC 61000-4-2
- EFT protection of data lines in accordance with IEC 61000-4-4
- Low incremental surge resistance
- Typical I_R less than 2µA when V_{BR} min>36V
- High temperature to reflow soldering guaranteed: 260°C/40sec / 0.375", (9.5mm) lead length, 5 lbs., (2.3kg) tension
- V_{BR} @ T_J = V_{BR} @ 25°C x (1 + α T x (T_J - 25)) (α T: Temperature Coefficient, typical value is 0.1%)
- UL Recognized compound meeting flammability rating V-0
- Matte tin lead-free plated
- Halogen free and RoHS compliant
- Pb-free E3 means 2nd level interconnect is Pb-free and the terminal finish material is tin(Sn) (IPC/ JEDEC J-STD-609A.01)
- Recognized to UL 497B

Applications

TVS components are ideal for the protection of I/O interfaces, V_{CC} bus and other vulnerable circuits used in telecom, computer, industrial and consumer electronic applications.

Additional Information



Datasheet



Resources



Samples

Electrical Characteristics (T_A=25°C unless otherwise noted)

| Part Number (Uni) | Part Number (Bi) | Reverse Stand off Voltage V _R (Volts) | Breakdown Voltage V _{BR} (Volts) @ I _T | | Test Current I _T (mA) | Maximum Peak Pulse Current I _{PP} (A) | Maximum Reverse Leakage I _R @ V _R (μA) | Maximum Clamping Voltage V _C @ I _{PP} (V) | Agency Recognition  |
|-------------------|------------------|--|--|-------|----------------------------------|--|--|---|--|
| | | | MIN | MAX | | | | | |
| 15KPA17A | 15KPA17CA | 17 | 18.99 | 20.79 | 50 | 515.4 | 5000 | 29.3 | X |
| 15KPA18A | 15KPA18CA | 18 | 20.11 | 22.01 | 50 | 488.7 | 5000 | 30.9 | X |
| 15KPA20A | 15KPA20CA | 20 | 22.34 | 24.46 | 20 | 440.2 | 1500 | 34.3 | X |
| 15KPA22A | 15KPA22CA | 22 | 24.57 | 26.91 | 10 | 407.0 | 500 | 37.1 | X |
| 15KPA24A | 15KPA24CA | 24 | 26.81 | 29.35 | 5 | 371.0 | 150 | 40.7 | X |
| 15KPA26A | 15KPA26CA | 26 | 29.04 | 31.80 | 5 | 343.2 | 50 | 44.0 | X |
| 15KPA28A | 15KPA28CA | 28 | 31.28 | 34.24 | 5 | 317.9 | 25 | 47.5 | X |
| 15KPA30A | 15KPA30CA | 30 | 33.51 | 36.70 | 5 | 297.8 | 15 | 50.7 | X |
| 15KPA33A | 15KPA33CA | 33 | 36.9 | 40.4 | 5 | 276.1 | 2 | 54.7 | X |
| 15KPA36A | 15KPA36CA | 36 | 40.2 | 44.0 | 5 | 252.5 | 2 | 59.8 | X |
| 15KPA40A | 15KPA40CA | 40 | 44.7 | 48.9 | 5 | 229.5 | 2 | 65.8 | X |
| 15KPA43A | 15KPA43CA | 43 | 48.0 | 52.6 | 5 | 216.3 | 2 | 69.8 | X |
| 15KPA45A | 15KPA45CA | 45 | 50.3 | 55.0 | 5 | 207.4 | 2 | 72.8 | X |
| 15KPA48A | 15KPA48CA | 48 | 53.6 | 58.7 | 5 | 194.3 | 2 | 77.7 | X |
| 15KPA51A | 15KPA51CA | 51 | 57.0 | 62.4 | 5 | 182.1 | 2 | 82.9 | X |
| 15KPA54A | 15KPA54CA | 54 | 60.3 | 66.0 | 5 | 172.2 | 2 | 87.7 | X |
| 15KPA58A | 15KPA58CA | 58 | 64.8 | 70.9 | 5 | 161.0 | 2 | 93.8 | X |
| 15KPA60A | 15KPA60CA | 60 | 67.0 | 73.4 | 5 | 155.0 | 2 | 97.4 | X |
| 15KPA64A | 15KPA64CA | 64 | 71.5 | 78.3 | 5 | 144.9 | 2 | 104.2 | X |
| 15KPA70A | 15KPA70CA | 70 | 78.2 | 85.6 | 5 | 132.9 | 2 | 113.6 | X |
| 15KPA75A | 15KPA75CA | 75 | 83.8 | 91.7 | 5 | 123.8 | 2 | 122.0 | X |
| 15KPA78A | 15KPA78CA | 78 | 87.1 | 95.4 | 5 | 119.7 | 2 | 126.1 | X |
| 15KPA85A | 15KPA85CA | 85 | 94.9 | 104.0 | 5 | 109.7 | 2 | 137.6 | X |
| 15KPA90A | 15KPA90CA | 90 | 100.5 | 110.1 | 5 | 103.7 | 2 | 145.6 | X |
| 15KPA100A | 15KPA100CA | 100 | 111.7 | 122.3 | 5 | 93.6 | 2 | 161.3 | X |
| 15KPA110A | 15KPA110CA | 110 | 122.9 | 134.5 | 5 | 84.5 | 2 | 178.6 | X |
| 15KPA120A | 15KPA120CA | 120 | 134.0 | 146.8 | 5 | 78.5 | 2 | 192.3 | X |
| 15KPA130A | 15KPA130CA | 130 | 145.2 | 159.0 | 5 | 72.5 | 2 | 208.3 | X |
| 15KPA150A | 15KPA150CA | 150 | 167.6 | 183.5 | 5 | 62.4 | 2 | 241.9 | X |
| 15KPA160A | 15KPA160CA | 160 | 178.7 | 195.7 | 5 | 58.4 | 2 | 258.6 | X |
| 15KPA170A | 15KPA170CA | 170 | 189.9 | 207.9 | 5 | 55.4 | 2 | 272.7 | X |
| 15KPA180A | 15KPA180CA | 180 | 201.1 | 220.1 | 5 | 52.3 | 2 | 288.5 | X |
| 15KPA200A | 15KPA200CA | 200 | 223.4 | 244.6 | 5 | 47.3 | 2 | 319.1 | X |
| 15KPA220A | 15KPA220CA | 220 | 245.7 | 269.1 | 5 | 42.4 | 2 | 356.0 | X |
| 15KPA240A | 15KPA240CA | 240 | 268.1 | 293.5 | 5 | 39.3 | 2 | 384.6 | X |
| 15KPA260A | 15KPA260CA | 260 | 290.4 | 318.0 | 5 | 36.2 | 2 | 416.7 | X |
| 15KPA280A | 15KPA280CA | 280 | 312.8 | 342.4 | 5 | 33.2 | 2 | 454.5 | X |

For bidirectional type having V_R of 30 volts and less, the I_R limit is double.

For parts without A, the V_{BR} is ±10% and V_C is 5% higher than with A parts, the parts without A are currently available, but not recommended for new designs. The parts with A are preferred.

I-V Curve Characteristics



- P_{PPM}** Peak Pulse Power Dissipation – Max power dissipation
- V_R** Stand-off Voltage – Maximum voltage that can be applied to the TVS without operation
- V_{BR}** Breakdown Voltage – Maximum voltage that flows through the TVS at a specified test current (I_T)
- V_C** Clamping Voltage – Peak voltage measured across the TVS at a specified I_{ppm} (peak impulse current)
- I_R** Reverse Leakage Current – Current measured at V_R
- V_F** Forward Voltage Drop for Uni-directional

Ratings and Characteristic Curves ($T_A=25^\circ\text{C}$ unless otherwise noted)

Figure 1 - TVS Transients Clamping Waveform

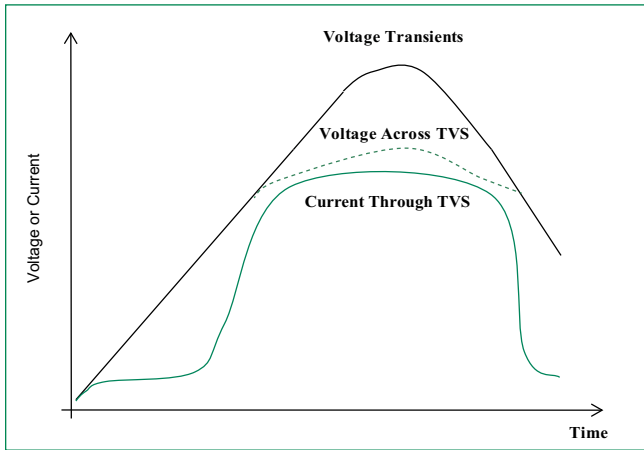
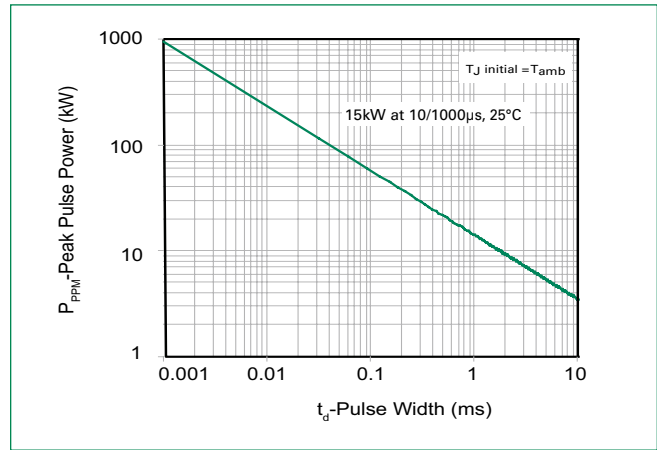

Figure 2 - Peak Pulse Power Rating Curve



Ratings and Characteristic Curves ($T_A=25^\circ\text{C}$ unless otherwise noted) (Continued)

Figure 3 - Peak Pulse Power Derating Curve

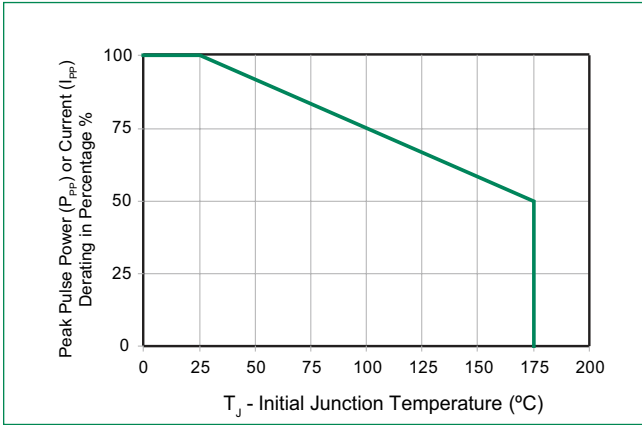

Figure 4 - Test Pulse Waveform

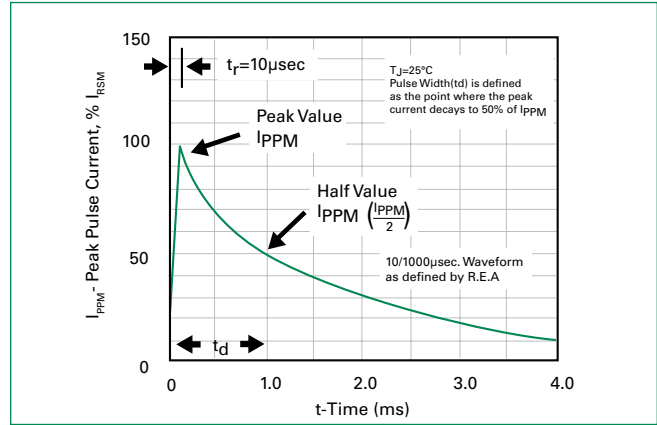

Figure 5 - Typical Junction Capacitance

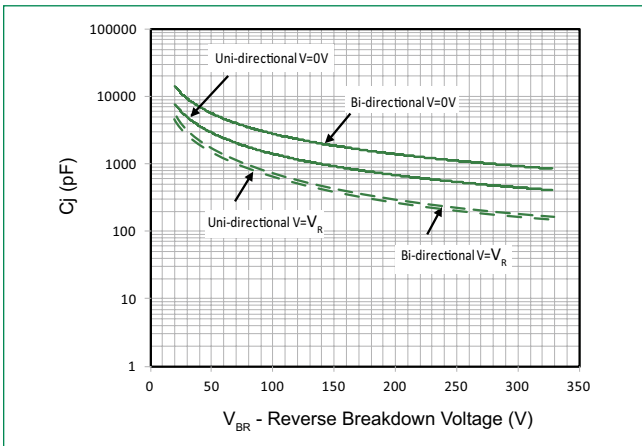

Figure 6 - Typical Transient Thermal Impedance

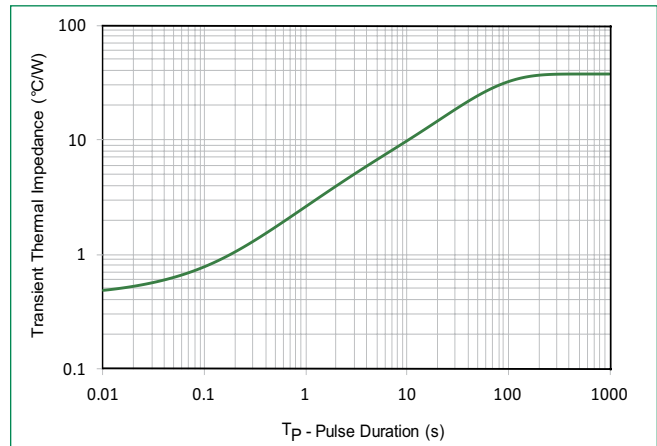

Figure 7 - Maximum Non-Repetitive Peak Forward Surge Current Uni-Directional Only

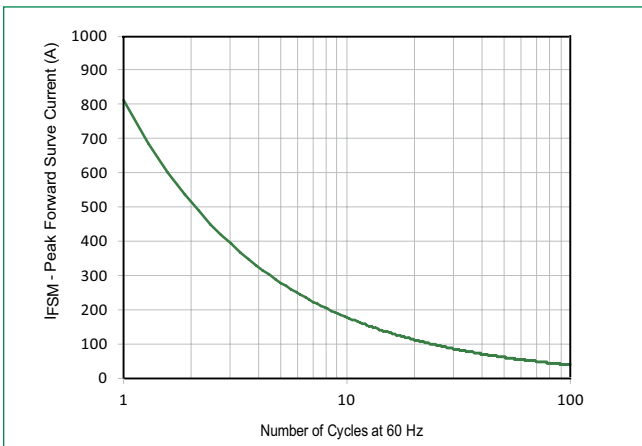
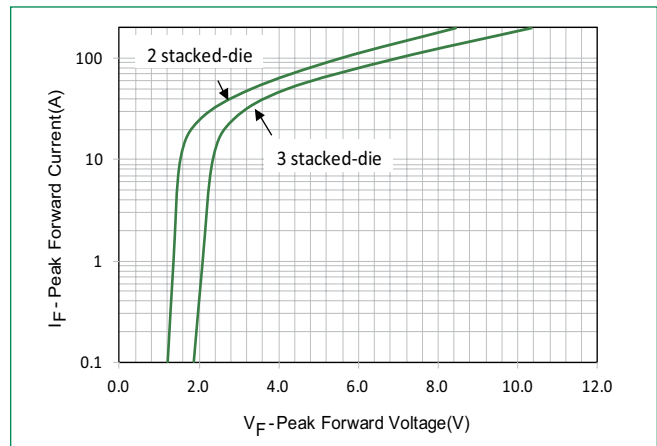

Figure 8 - Peak Forward Voltage Drop vs Peak Forward Current (Typical Values)



Soldering Parameters

| | | |
|--|------------------------------------|-------------------------|
| Reflow Condition | | Lead-free assembly |
| Pre Heat | - Temperature Min ($T_{s(min)}$) | 150°C |
| | - Temperature Max ($T_{s(max)}$) | 200°C |
| | - Time (min to max) (t_s) | 60 – 180 secs |
| Average ramp up rate (Liquidus Temp (T_A) to peak) | | 3°C/second max |
| $T_{s(max)}$ to T_A - Ramp-up Rate | | 3°C/second max |
| Reflow | - Temperature (T_A) (Liquidus) | 217°C |
| | - Time (min to max) (t_s) | 60 – 150 seconds |
| Peak Temperature (T_p) | | 260 ^{+0/-5} °C |
| Time within 5°C of actual peak Temperature (t_p) | | 20 – 40 seconds |
| Ramp-down Rate | | 6°C/second max |
| Time 25°C to peak Temperature (T_p) | | 8 minutes Max. |
| Do not exceed | | 260°C |



Flow/Wave Soldering (Solder Dipping)

| | |
|---------------------------|------------|
| Peak Temperature : | 265°C |
| Dipping Time : | 10 seconds |
| Soldering : | 1 time |

Physical Specifications

| | |
|-----------------|--|
| Weight | 0.07oz., 2.5g |
| Case | P600 molded plastic body over passivated junction. |
| Polarity | Color band denotes the cathode except Bipolar. |
| Terminal | Matte Tin axial leads, solderable per JESD22-B102. |

Environmental Specifications

| | |
|----------------------------|-------------|
| High Temp. Storage | JESD22-A103 |
| HTRB | JESD22-A108 |
| Temperature Cycling | JESD22-A104 |
| H3TRB | JESD22-A101 |
| RSH | JESD22-B106 |

Dimensions

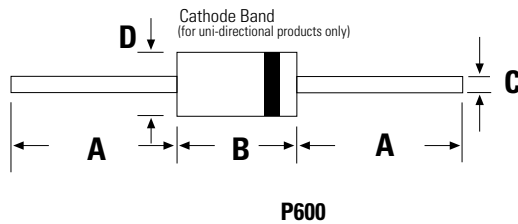

| Dimensions | Inches | | Millimeters | |
|------------|--------|-------|-------------|------|
| | Min | Max | Min | Max |
| A | 1.000 | - | 25.40 | - |
| B | 0.340 | 0.360 | 8.60 | 9.10 |
| C | 0.048 | 0.054 | 1.22 | 1.36 |
| D | 0.340 | 0.360 | 8.60 | 9.10 |

Part Numbering System

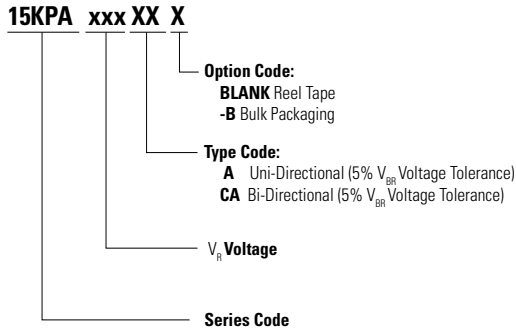

Part Marking System

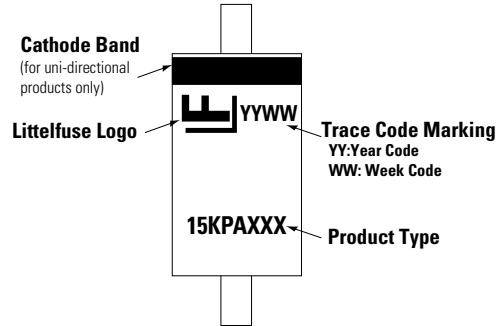

Packing Options

| Part Number | Component Package | Quantity | Packaging Option | Packaging Specification |
|--------------|-------------------|----------|------------------|-------------------------|
| 15KPAxxxXX | P600 | 800 | Tape & Reel | EIA STD RS-296 |
| 15KPAxxxXX-B | P600 | 100 | Bulk | Littelfuse Spec. |

Tape and Reel Specification

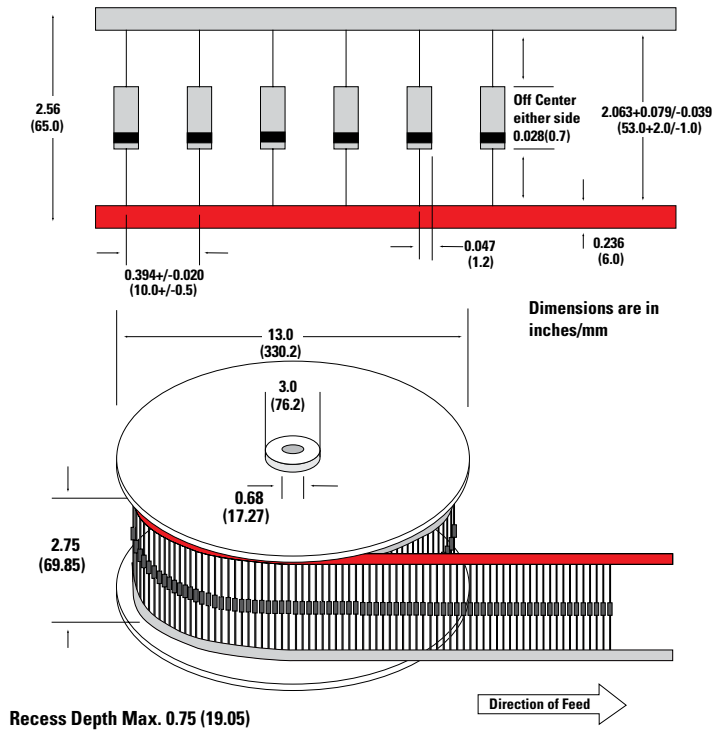

Looking for pricing, stock, or lifecycle information?

Click below to explore more details on WIN SOURCE:

 [View 15KPA48A on WIN SOURCE](#)

 [Littelfuse Inc. Information](#)

Optimize Your Supply Chain with WIN SOURCE Solutions

-  Global Sourcing Solution
-  Obsolete Management
-  Cost Control Management
-  Shortage Management
-  Alternative Solution
-  Excess Inventory Management