



THE DATASHEET OF MPC8378CVRALGA



MPC837x PowerQUICC® II Pro

Overview

Today's small-to-medium business (SMB) and consumer applications are driving the need for highly integrated and cost effective solutions that deliver high performance. The next generation PowerQUICC® II Pro MPC837x family provides an e300 core, built on Power Architecture® technology, integrated with PCI Express® and Serial-ATA (SATA) controllers, as well as dual Gigabit Ethernet controllers, to specifically address the needs of SMB and consumer applications. The new MPC837x family, based in 90 nm process technology, provides high integration that simplifies board design and offers a cost-effective solution that is critical for applications such as wireless access points, printers, network attached storage and SMB routers.

e300 Platform Built on Power Architecture Technology

The next generation MPC837x family utilizes the 32-bit superscalar e300 core. It integrates two integer units and a floating-point unit, making it ideal for computational applications. It supports 32 KB L1 data and instruction cache, and has an operating frequency from 400 MHz to 800 MHz. The MPC837x family is software compatible with existing 603e core-based products.

Integrated Fabric Controllers (PCI Express & Serial-ATA)

A key differentiator for the MPC837x family is the integration of PCI Express and Serial-ATA (SATA), which reduces the number of external controller chips and provides customers with a cost-effective solution. The PCI Express controller is revision 1.0a compatible

MPC837x Family Block Diagram

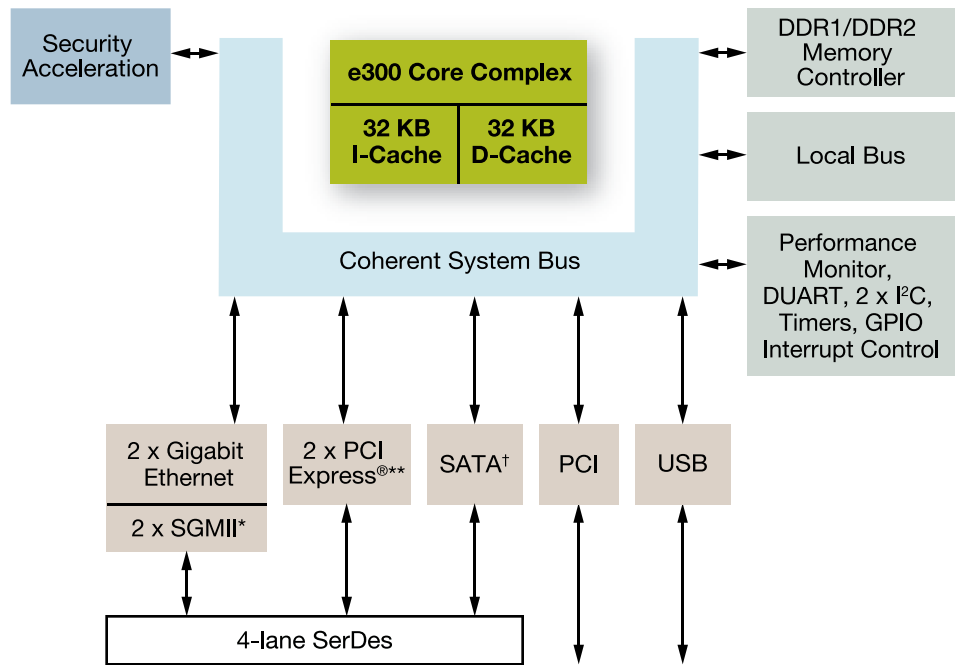

Note

*SGMII only available on MPC8378

**PCI-Express only available on MPC8378, MPC8377

†SATA only available on MPC8377 (2 x SATA), MPC8379 (4 x SATA)

■ Core ■ Accelerators ■ I/O

and supports either x1 or x2 widths, making it an excellent choice for wireless access points and low-end printers. The integrated SATA controllers support both SATA I and II data rates (1.5 and 3.0 Gbaud), providing integrated support for hard disk drive applications such as network attached storage.

Key Advantages

- High performance e300 core operating up to 800 MHz with 32 KB L1 cache
- Integrated PCI Express and SATA controllers providing a cost-effective System-on-Chip (SoC) solution
- Key networking capabilities enabled by dual Gigabit Ethernet ports
- Integrated security engine

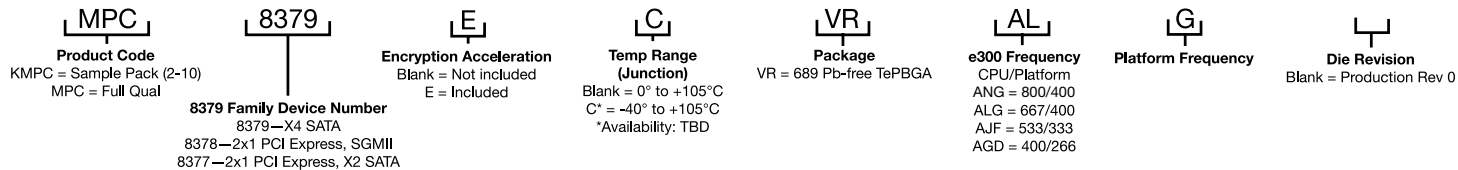

MPC837xE PowerQUICC® II Pro Family	MPC8379E	MPC8378E	MPC8377E
Core	e300	e300	e300
CPU Speed	400, 533, 667, 800 MHz	400, 533, 667, 800 MHz	400, 533, 667, 800 MHz
L1 I/D Cache	32 KB	32 KB	32 KB
Memory Controller	32/64-bit DDR/2 up to 400 MHz	32/64-bit DDR/2 up to 400 MHz	32/64-bit DDR/2 up to 400 MHz
Local Bus	32-bit with NAND boot support	32-bit with NAND boot support	32-bit with NAND boot support
PCI	32-bit up to 66 MHz (2.3)	32-bit up to 66 MHz (2.3)	32-bit up to 66 MHz (2.3)
PCI Express®	–	2x1 or 1x2	2x1 or 1x2
SATA	4 x 1 SATA 2.0 with PHY	–	2 x 1 SATA 2.0 with PHY
Ethernet	Two 10/100/1000 (RGMII, RTBI, RMII, MII)	Two 10/100/1000 (SGMII, RGMII, RTBI, RMII, MII)	Two 10/100/1000 (RGMII, RTBI, RMII, MII)
USB	One 2.0 Host or Device	One 2.0 Host or Device	One 2.0 Host or Device
Security	E version only	E version only	E version only
Additional Interfaces	2 x UART, 2 x I ² C, SPI	2 x UART, 2 x I ² C, SPI	2 x UART, 2 x I ² C, SPI
Interrupt Controller	Yes	Yes	Yes
Package	689 Te PBGA	689 Te PBGA	689 Te PBGA

Technical Specifications

- e300 core built on Power Architecture technology
 - Operating from 400 to 800 MHz
 - Integrated floating point and dual integer units
 - 32 KB L1 data and instruction cache with parity checking
- Memory Controller
 - 32- or 64-bit DDR1/2 memory controller, up to 400 MHz data rate
- I/O Support
 - Dual 10/100/1000 Ethernet Controllers with support for MII, RMII, RGMII, RTBI and SGMII
 - Support for IEEE® 1588
 - USB 2.0 host and device controller
- 32-bit PCI interface operating up to 66 MHz, Rev 2.3 compatible
- PCI Express with two interfaces support x1 and x2 widths
- Integrated SATA controllers with support for SATA I and II (1.5 Gbps and 3 Gbps),
- Integrated Security (optional, indicated with an E in the device number)
 - Public Key Encryption unit supports RSA and Diffie Hellman
 - Data Encryption Standard Execution Unit supports DES/3DES, ECB, CBC and OFB modes
 - Advanced Encryption Standard Unit supports key lengths up to 256b, and supports ECB, CBC, CTR, CCM, GCM, CMAC, OFB, CFB and LRW
- Message Digest Execution unit supports HSA1/2 and SHA-384/512
- ARC Four Execution Unit, Kasumi Execution Unit and CRC Execution Unit
- XOR acceleration
- Additional Support
 - An enhanced local bus controller with support for boot from NAND and NOR flash
 - 4-channel DMA controller
 - Dual I²C controller, DUART, SPI interface

Learn More: For current information about Freescale products and documentation, please visit www.freescale.com.



Freescale and the Freescale logo are trademarks or registered trademarks of Freescale Semiconductor, Inc. in the U.S. and other countries. All other product or service names are the property of their respective owners. The Power Architecture and Power.org word marks and the Power and Power.org logos and related marks are trademarks and service marks licensed by Power.org. © Freescale Semiconductor, Inc. 2009.

Document Number: MPC837XFFS
REV 1



Looking for pricing, stock, or lifecycle information?

Click below to explore more details on WIN SOURCE:

 [View MPC8378CVRALGA on WIN SOURCE](#)

 [NXP / Nexperia Information](#)

Optimize Your Supply Chain with WIN SOURCE Solutions

-  Global Sourcing Solution
-  Obsolete Management
-  Cost Control Management
-  Shortage Management
-  Alternative Solution
-  Excess Inventory Management