



**THE DATASHEET OF  
DEBB33F221KCDB**



⚠Note • This PDF catalog is downloaded from the website of Murata Manufacturing co., Ltd. Therefore, it's specifications are subject to change or our products in it may be discontinued without advance notice. Please check with our sales representatives or product engineers before ordering.  
• This PDF catalog has only typical specifications because there is no space for detailed specifications. Therefore, please approve our product specifications or transact the approval sheet for product specifications before ordering.

C85E.pdf  
08.10.29

# Safety Certified Ceramic Capacitors/ High Voltage Ceramic Capacitors



Cat.No.C85E-2

**muRata** *Innovator  
in Electronics*  
Murata  
Manufacturing Co., Ltd.

⚠Note • This PDF catalog is downloaded from the website of Murata Manufacturing co., Ltd. Therefore, it's specifications are subject to change or our products in it may be discontinued without advance notice. Please check with our sales representatives or product engineers before ordering.  
• This PDF catalog has only typical specifications because there is no space for detailed specifications. Therefore, please approve our product specifications or transact the approval sheet for product specifications before ordering.

C85E.pdf  
08.10.29

**for EU RoHS Compliant**

- All the products in this catalog comply with EU RoHS.
- EU RoHS is "the European Directive 2002/95/EC on the Restriction of the Use of Certain Hazardous Substances in Electrical and Electronic Equipment".
- For more details, please refer to our website 'Murata's Approach for EU RoHS' (<http://www.murata.com/info/rohs.html>).



# CONTENTS

<b>Part Numbering</b>	2
<b>1 Type KY (Basic Insulation) -IEC60384-14 Class X1, Y2-</b>	4
<b>2 Type KH (Basic Insulation) -IEC60384-14 Class X1, Y2-</b>	6
<b>3 Type KX Small Size (Reinforced Insulation) -IEC60384-14 Class X1, Y1-</b>	8
<b>4 Type KX (Reinforced Insulation) -IEC60384-14 Class X1, Y1-</b>	10
● Type KY/KH/KX Specifications and Test Methods	12
<b>5 DEJ Series -Based on the Electrical Appliance and Material Safety Law of Japan-</b>	16
● DEJ Series Specifications and Test Methods	17
<b>Safety Certified Ceramic Capacitors Characteristics Data (Typical Example)</b>	20
<b>Safety Certified Ceramic Capacitors Packaging</b>	23
<b>Safety Certified Ceramic Capacitors △Caution</b>	25
<b>Safety Certified Ceramic Capacitors Notice</b>	28
<b>6 DES Series (125 deg. C Guaranteed/Low-dissipation Factor/DC500V-1kV)</b>	29
● DES Series Specifications and Test Methods	31
<b>7 DEH Series (125 deg. C Guaranteed/Low-dissipation Factor/DC250V-3.15kV)</b>	33
● DEH Series Specifications and Test Methods	36
<b>8 DEA Series (125 deg. C Guaranteed/Class 1/DC1k-3.15kV)</b>	39
● DEA Series Specifications and Test Methods	42
<b>9 DEB Series (Class 2/DC1k-3.15kV)</b>	44
● DEB Series Specifications and Test Methods	47
<b>10 DEC Series (Class 1, 2/DC6.3kV)</b>	49
● DEC Series Specifications and Test Methods	51
<b>11 DEF Series (Only for LCD Backlight Inverter Circuit/6.3kVp-p)</b>	53
● DEF Series Specifications and Test Methods	55
<b>High Voltage Ceramic Capacitors Characteristics Data (Typical Example)</b>	57
<b>High Voltage Ceramic Capacitors Packaging</b>	58
<b>High Voltage Ceramic Capacitors △Caution</b>	60
<b>High Voltage Ceramic Capacitors Notice</b>	68
<b>Safety Certified Ceramic Capacitors/High Voltage Ceramic Capacitors ISO9000 Certifications</b>	69

1

2

3

4

5

6

7

8

9

10

11

● Part Numbering

Safety Standard Certified Ceramic Capacitors

(Part Number) 

DE	2	E3	KH	102	M	N3	A	
①	②	③	④	⑤	⑥	⑦	⑧	⑨

① Product ID

Product ID	
<b>DE</b>	Safety Standard Certified Ceramic Capacitors / High Voltage Ceramic Capacitors

② Series Category

Code	Outline	Contents
<b>1</b>	Safety Standard Certified	IEC60384-14 Class X1, Y1
<b>2</b>		IEC60384-14 Class X1, Y2
<b>J</b>	AC250V (r.m.s.)	"Products which are based on the Electrical Appliance and Material Safety Law of Japan"

In case of Electrical Appliance and Material Safety Law of Japan, first three digits (① Product ID and ② Series Category) express "Series Name".

In case of Safety Certified Capacitors, first three digits express product code. The following fourth figure expresses certified type shown in ④ Safety Standard Certified Type column.

③ Temperature Characteristics

Code	Temperature Characteristics	Cap.Change or Temp. Coeff.	Temperature Range
<b>B3</b>	B	±10%	-25 to +85°C
<b>E3</b>	E	+20%, -55%	
<b>F3</b>	F	+30%, -80%	
<b>1X</b>	SL	+350 to -1000ppm/°C	+20 to +85°C

④ Rated Voltage/Safety Standard Certified Type

Code	Rated Voltage
<b>E2</b>	AC250V
<b>KH</b>	X1, Y2; AC250V, (Safety Standard Certified Type KH)
<b>KY</b>	X1, Y2; AC250V, (Safety Standard Certified Type KY)
<b>KX</b>	X1, Y1; AC250V, (Safety Standard Certified Type KX)

⑤ Capacitance

Expressed by three figures. The unit is pico-farad (pF). The first and second figures are significant digits, and the third figure expresses the number of zeros which follow the two numbers.

⑥ Capacitance Tolerance

Code	Capacitance Tolerance
<b>J</b>	±5%
<b>K</b>	±10%
<b>M</b>	±20%
<b>Z</b>	+80%, -20%

⑦ Lead Style

Code	Lead Style	Dimensions (mm)			
		Lead Spacing	Lead Diameter	Pitch of Components	
<b>A2</b>	Vertical Crimp Long	5	ø0.6±0.05	-	
<b>A3</b>		7.5			
<b>A4</b>		10			
<b>A5</b>	Vertical Crimp Short	10	ø0.6+0.1, -0.05	-	
<b>B2</b>		5	ø0.6±0.05		
<b>B3</b>		7.5			
<b>B4</b>	10				
<b>B5</b>	10	ø0.6+0.1, -0.05	-		
<b>C3</b>	Straight Long	7.5		ø0.6±0.05	
<b>D3</b>	Straight Short	7.5		ø0.6±0.05	
<b>N2</b>	Vertical Crimp Taping	5	ø0.6±0.05	12.7	
<b>N3</b>		7.5		15	
<b>N4</b>		10		25.4	
<b>N5</b>		10		ø0.6+0.1, -0.05	25.4
<b>N7</b>		7.5		ø0.6±0.05	30
<b>P3</b>	Straight Taping	7.5	ø0.6±0.05	15	

⑧ Packaging

Code	Packaging
<b>A</b>	Ammo Pack Taping Type
<b>B</b>	Bulk Type

⑨ Individual Specification Code

In case part number cannot be identified without "Individual Specification", it is added at the end of part number. Expressed by three-digit alphanumerics.

## High Voltage Ceramic Capacitors (250V-6.3kV)

(Part Number) 

DE	B	B3	3A	102	K	N2	A	
①	②	③	④	⑤	⑥	⑦	⑧	⑨

### ① Product ID

Product ID	
DE	High Voltage Ceramic Capacitors (250V-6.3kV) / Safety Standard Certified Ceramic Capacitors

### ② Series Category

Code	Outline	Contents
A	High Voltage	Class 1 (Char. SL) DC1-3.15kV Rated
B		Class 2 DC1-3.15kV Rated
C		Class 1, 2 DC6.3kV Rated
H		High Temperature Guaranteed, Low-dissipation Factor (Char. R, C)
S		High Temperature Guaranteed, Low-dissipation Factor (Char. D)
F		LCD Backlight Inverter Circuit

First three digits (① Product ID and ② Series Category) express "Series Name".

### ③ Temperature Characteristics

Code	Temperature Characteristics	Cap. Change or Temp. Coeff.	Temperature Range
B3	B	±10%	-25 to +85°C
E3	E	+20%, -55%	
F3	F	+30%, -80%	
C3	C	±20%	-25 to +85°C
		+15%, -30%	+85 to +125°C
R3	R	±15%	-25 to +85°C
		+15%, -30%	+85 to +125°C
D3	D	+20%, -30%	-25 to +125°C
1X	SL	+350 to -1000ppm/°C	+20 to +85°C
2C	CH	0±60ppm/°C	+20 to +85°C

### ④ Rated Voltage

Code	Rated Voltage
2E	DC250V
2H	DC500V
3A	DC1kV
3D	DC2kV
3F	DC3.15kV
3J	DC6.3kV
LH	6.3kVp-p

### ⑤ Capacitance

Expressed by three figures. The unit is pico-farad (pF). The first and second figures are significant digits, and the third figure expresses the number of zeros which follow the two numbers.

### ⑥ Capacitance Tolerance

Code	Capacitance Tolerance
C	±0.25pF
D	±0.5pF
J	±5%
K	±10%
Z	+80%, -20%

### ⑦ Lead Style

Code	Lead Style	Dimensions (mm)		
		Lead Spacing	Lead Diameter	Pitch of Components
A2	Vertical Crimp Long	5	ø0.6±0.05	-
A3		7.5		
A4		10		
B2/J2	Vertical Crimp Short	5	ø0.6±0.05	-
B3/J3		7.5		
B4		10		
C1	Straight Long	5	ø0.5±0.05	-
C3		7.5		
C4		10		
CD		7.5	ø0.5±0.05	
D1	Straight Short	5	ø0.5±0.05	-
D3		7.5		
DD		7.5		
N2	Vertical Crimp Taping	5	ø0.6±0.05	12.7
N3		7.5		15
N7		7.5		30
P2	Straight Taping	5	ø0.6±0.05	12.7
P3		7.5		15

### ⑧ Packaging

Code	Packaging
A	Ammo Pack Taping Type
B	Bulk Type

### ⑨ Individual Specification Code

In case part number cannot be identified without "Individual Specification", it is added at the end of part number. Expressed by three-digit alphanumerics.

# Safety Certified Ceramic Capacitors/High Voltage Ceramic Capacitors



## Type KY (Basic Insulation) -IEC60384-14 Class X1, Y2-

### ■ Features

1. We design capacitors in much more compact size than type KH, having reduced the diameter by 25% max.
2. Operating temperature range guaranteed up to 125 degrees (UL: 85 deg.).
3. Dielectric strength:  
AC2000V (In case of lead spacing F=5mm)  
AC2600V (In case of lead spacing F=7.5mm)
4. Class X1/Y2 capacitors which are certified by UL/CSA/VDE/BSI/SEMKO/DEMKO/FIMKO/NEMKO/ESTI/NSW.
5. Coated with flame-retardant epoxy resin (conforming to UL94V-0 standard).
6. Cost-saving automatic insertion available.

### ■ Applications

1. Ideal for use as X/Y capacitors for AC line filter and primary-secondary coupling on switching power supplies and AC adapters.
2. Ideal for use on D-A isolation and noise absorption for DAA modems without transformers.

Do not use these products in any Automotive Power train or Safety equipment including Battery charger for Electric Vehicles and Plug-in Hybrid. Only Murata products clearly stipulated as "for Automotive use" on its catalog can be used for automobile applications such as Power train and Safety equipment.

### ■ Standard Certification

	Standard No.	Certified No.	Rated Voltage
UL	UL1414	E37921	AC250V(r.m.s.)
CSA	E384-14	1283280	
VDE	IEC 60384-14 EN 60384-14	40006273	
BSI	EN 60065 (8.8, 14.2)	KM 37901	
	IEC 60384-14 EN 60384-14		
SEMKO		812168	
DEMKO		314115	
FIMKO	IEC 60384-14	24197	
NEMKO	EN 60384-14	P08209361	
ESTI		08.0710	
NSW	IEC 60384-14 AS3250	6824	

- The certification number might change by the revision of the application standard and the change within the range of acquisition.
- Please contact us when the certification of Chinese Safety Standard or South Korean Safety Standard is necessary.

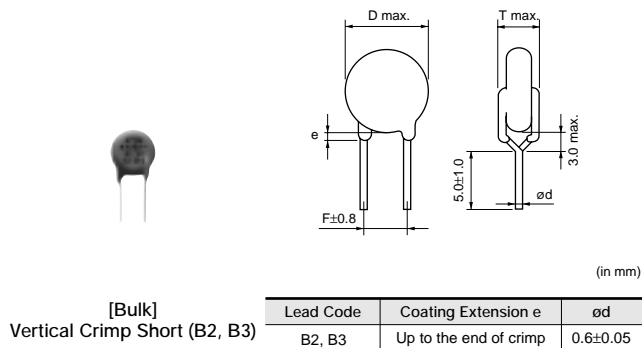
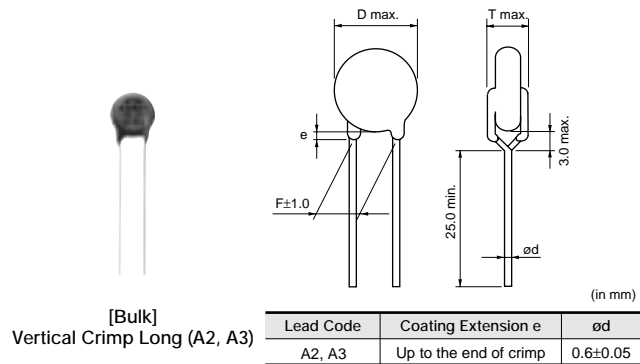

### ■ Marking

Example	Item
	① Type Designation KY
	② Nominal Capacitance (Under 100pF: Actual value, 100pF and over: Marked with 3 figures)
	③ Capacitance Tolerance
	④ Company Name Code Ⓜ8 : Made in Taiwan Ⓜ15 : Made in Thailand
	⑤ Manufactured Date Code
	Class Code X1Y2 Rated Voltage Mark 250~

### Lead Spacing F=7.5mm

Part Number	AC Rated Voltage (Vac)	Temp. Char.	Capacitance (pF)	Body Dia. D (mm)	Lead Spacing F (mm)	Body Thickness T (mm)	Lead Package Long Bulk	Lead Package Short Bulk	Lead Package Taping (1)
DE21XKY100J□□□M02	250	SL	10 ±5%	8 max.	7.5	5.0 max.	A3B	B3B	N3A
DE21XKY150J□□□M02	250	SL	15 ±5%	8 max.	7.5	5.0 max.	A3B	B3B	N3A
DE21XKY220J□□□M02	250	SL	22 ±5%	8 max.	7.5	5.0 max.	A3B	B3B	N3A
DE21XKY330J□□□M02	250	SL	33 ±5%	8 max.	7.5	5.0 max.	A3B	B3B	N3A
DE21XKY470J□□□M02	250	SL	47 ±5%	8 max.	7.5	5.0 max.	A3B	B3B	N3A
DE21XKY680J□□□M02	250	SL	68 ±5%	8 max.	7.5	5.0 max.	A3B	B3B	N3A
DE2B3KY101K□□□M02	250	B	100 ±10%	7 max.	7.5	5.0 max.	A3B	B3B	N3A
DE2B3KY151K□□□M02	250	B	150 ±10%	7 max.	7.5	5.0 max.	A3B	B3B	N3A
DE2B3KY221K□□□M02	250	B	220 ±10%	7 max.	7.5	5.0 max.	A3B	B3B	N3A
DE2B3KY331K□□□M02	250	B	330 ±10%	7 max.	7.5	5.0 max.	A3B	B3B	N3A
DE2B3KY471K□□□M02	250	B	470 ±10%	7 max.	7.5	5.0 max.	A3B	B3B	N3A
DE2B3KY681K□□□M02	250	B	680 ±10%	8 max.	7.5	5.0 max.	A3B	B3B	N3A
DE2E3KY102M□□□M02	250	E	1000 ±20%	7 max.	7.5	5.0 max.	A3B	B3B	N3A
DE2E3KY152M□□□M02	250	E	1500 ±20%	7 max.	7.5	5.0 max.	A3B	B3B	N3A
DE2E3KY222M□□□M02	250	E	2200 ±20%	8 max.	7.5	5.0 max.	A3B	B3B	N3A
DE2E3KY332M□□□M02	250	E	3300 ±20%	9 max.	7.5	5.0 max.	A3B	B3B	N3A
DE2E3KY472M□□□M02	250	E	4700 ±20%	10 max.	7.5	5.0 max.	A3B	B3B	N3A
DE2F3KY103M□□□M02	250	F	10000 ±20%	14 max.	7.5	5.0 max.	A3B	B3B	N3A

Three blank columns are filled with the lead and packaging codes. Please refer to the 3 columns on the right for the appropriate code.

Individual specification code "M02" expresses "simplicity marking and guarantee of dielectric strength between lead wires: AC2600V".

Murata part numbers might be changed depending on lead code or any other changes. Therefore, please specify only the type name (KY) and capacitance of products in the parts list when it is required for applying safety standard of electric equipment.

### Lead Spacing F=5mm

Part Number	AC Rated Voltage (Vac)	Temp. Char.	Capacitance (pF)	Body Dia. D (mm)	Lead Spacing F (mm)	Body Thickness T (mm)	Lead Package Long Bulk	Lead Package Short Bulk	Lead Package Taping (1)
DE21XKY100J□□□M01	250	SL	10 ±5%	8 max.	5.0	5.0 max.	A2B	B2B	N2A
DE21XKY150J□□□M01	250	SL	15 ±5%	8 max.	5.0	5.0 max.	A2B	B2B	N2A
DE21XKY220J□□□M01	250	SL	22 ±5%	8 max.	5.0	5.0 max.	A2B	B2B	N2A
DE21XKY330J□□□M01	250	SL	33 ±5%	8 max.	5.0	5.0 max.	A2B	B2B	N2A
DE21XKY470J□□□M01	250	SL	47 ±5%	8 max.	5.0	5.0 max.	A2B	B2B	N2A
DE21XKY680J□□□M01	250	SL	68 ±5%	8 max.	5.0	5.0 max.	A2B	B2B	N2A
DE2B3KY101K□□□M01	250	B	100 ±10%	7 max.	5.0	5.0 max.	A2B	B2B	N2A
DE2B3KY151K□□□M01	250	B	150 ±10%	7 max.	5.0	5.0 max.	A2B	B2B	N2A
DE2B3KY221K□□□M01	250	B	220 ±10%	7 max.	5.0	5.0 max.	A2B	B2B	N2A
DE2B3KY331K□□□M01	250	B	330 ±10%	7 max.	5.0	5.0 max.	A2B	B2B	N2A
DE2B3KY471K□□□M01	250	B	470 ±10%	7 max.	5.0	5.0 max.	A2B	B2B	N2A
DE2B3KY681K□□□M01	250	B	680 ±10%	8 max.	5.0	5.0 max.	A2B	B2B	N2A
DE2E3KY102M□□□M01	250	E	1000 ±20%	7 max.	5.0	5.0 max.	A2B	B2B	N2A
DE2E3KY152M□□□M01	250	E	1500 ±20%	7 max.	5.0	5.0 max.	A2B	B2B	N2A
DE2E3KY222M□□□M01	250	E	2200 ±20%	8 max.	5.0	5.0 max.	A2B	B2B	N2A
DE2E3KY332M□□□M01	250	E	3300 ±20%	9 max.	5.0	5.0 max.	A2B	B2B	N2A
DE2E3KY472M□□□M01	250	E	4700 ±20%	10 max.	5.0	5.0 max.	A2B	B2B	N2A

Three blank columns are filled with the lead and packaging codes. Please refer to the 3 columns on the right for the appropriate code.

Individual specification code "M01" expresses "simplicity marking and guarantee of dielectric strength between lead wires: AC2000V".

Murata part numbers might be changed depending on lead code or any other changes. Therefore, please specify only the type name (KY) and capacitance of products in the parts list when it is required for applying safety standard of electric equipment.

# Safety Certified Ceramic Capacitors/High Voltage Ceramic Capacitors



## Type KH (Basic Insulation) -IEC60384-14 Class X1, Y2-

2

### ■ Features

1. Operating temperature range guaranteed up to 125 degrees (UL: 85 deg.).
2. Dielectric strength: AC2600V
3. Class X1/Y2 capacitors which are certified by UL/CSA/VDE/BSI/SEMKO/DEMKO/FIMKO/NEMKO/ESTI/NSW.
4. Coated with flame-retardant epoxy resin (conforming to UL94V-0 standard).
5. Cost-saving automatic insertion available.

### ■ Applications

Ideal for use as X/Y capacitors for AC line filter and primary-secondary coupling on switching power supplies and AC adapters.

Do not use these products in any Automotive Power train or Safety equipment including Battery charger for Electric Vehicles and Plug-in Hybrid. Only Murata products clearly stipulated as "for Automotive use" on its catalog can be used for automobile applications such as Power train and Safety equipment.

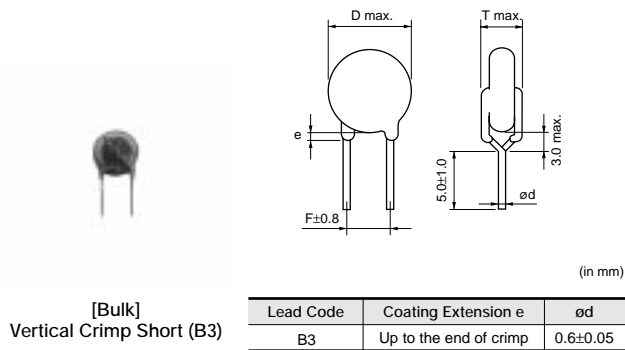
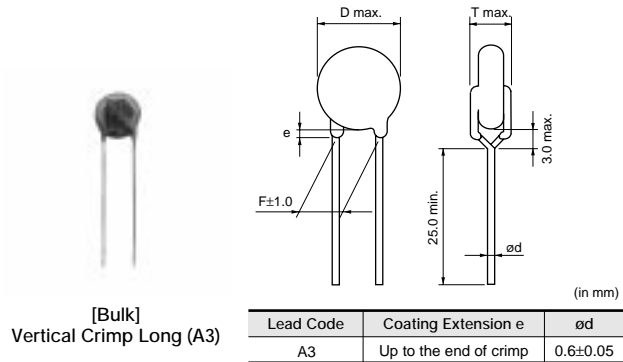

### ■ Standard Certification

	Standard No.	Certified No.	Rated Voltage
UL	UL1414	E37921	AC250V(r.m.s.)
CSA	E384-14	1343805	
VDE	IEC 60384-14 EN 60384-14	40002796	
BSI	EN 60065 (8.8, 14.2) IEC 60384-14 EN 60384-14	KM 37901	
		812163	
SEMKO	IEC 60384-14 EN 60384-14	314578	
DEMKO		24195	
FIMKO	EN 60384-14	P08209182	
NEMKO		08.0708	
ESTI	IEC 60384-14 AS3250	6529	
NSW			

- The certification number might change by the revision of the application standard and the change within the range of acquisition.
- Please contact us when the certification of Chinese Safety Standard or South Korean Safety Standard is necessary.

### ■ Marking

Example	Item
	① Type Designation KH
	② Nominal Capacitance (Marked with 3 figures)
	③ Capacitance Tolerance
	④ Company Name Code Ⓒ8: Made in Taiwan Ⓒ15: Made in Thailand
	⑤ Manufactured Date Code
	UL Approval Mark
	CSA Approval Mark
	VDE Approval Mark
	BSI Approval Mark BSI
	SEMKO Approval Mark
	DEMKO Approval Mark
FIMKO Approval Mark	
NEMKO Approval Mark	
ESTI Approval Mark	
Class Code X1Y2	
Rated Voltage Mark 250~	

⚠Note • This PDF catalog is downloaded from the website of Murata Manufacturing co., Ltd. Therefore, it's specifications are subject to change or our products in it may be discontinued without advance notice. Please check with our sales representatives or product engineers before ordering.  
 • This PDF catalog has only typical specifications because there is no space for detailed specifications. Therefore, please approve our product specifications or transact the approval sheet for product specifications before ordering.

Part Number	AC Rated Voltage (Vac)	Temp. Char.	Capacitance (pF)	Body Dia. D (mm)	Lead Spacing F (mm)	Body Thickness T (mm)	Lead Package Long Bulk	Lead Package Short Bulk	Lead Package Taping (1)
DE2B3KH101K□□□	250	B	100 ±10%	8 max.	7.5	7.0 max.	A3B	B3B	N3A
DE2B3KH151K□□□	250	B	150 ±10%	8 max.	7.5	7.0 max.	A3B	B3B	N3A
DE2B3KH221K□□□	250	B	220 ±10%	8 max.	7.5	7.0 max.	A3B	B3B	N3A
DE2B3KH331K□□□	250	B	330 ±10%	8 max.	7.5	7.0 max.	A3B	B3B	N3A
DE2B3KH471K□□□	250	B	470 ±10%	8 max.	7.5	7.0 max.	A3B	B3B	N3A
DE2B3KH681K□□□	250	B	680 ±10%	9 max.	7.5	7.0 max.	A3B	B3B	N3A
DE2E3KH102M□□□	250	E	1000 ±20%	8 max.	7.5	7.0 max.	A3B	B3B	N3A
DE2E3KH152M□□□	250	E	1500 ±20%	9 max.	7.5	7.0 max.	A3B	B3B	N3A
DE2E3KH222M□□□	250	E	2200 ±20%	10 max.	7.5	7.0 max.	A3B	B3B	N3A
DE2E3KH332M□□□	250	E	3300 ±20%	12 max.	7.5	7.0 max.	A3B	B3B	N3A
DE2E3KH472M□□□	250	E	4700 ±20%	13 max.	7.5	7.0 max.	A3B	B3B	N3A
DE2F3KH103M□□□	250	F	10000 ±20%	16 max.	7.5	7.0 max.	A3B	B3B	N7A

Three blank columns are filled with the lead and packaging codes. Please refer to the 3 columns on the right for the appropriate code.  
 Murata part numbers might be changed depending on lead code or any other changes. Therefore, please specify only the type name (KH) and capacitance of products in the parts list when it is required for applying safety standard of electric equipment.

## Safety Certified Ceramic Capacitors/High Voltage Ceramic Capacitors



### Type KX Small Size (Reinforced Insulation) -IEC60384-14 Class X1, Y1-

3

#### ■ Features

1. We design capacitors in much more compact size than current Type KX, having reduced the diameter by 20% max.
2. Operating temperature range guaranteed up to 125 degrees (UL: 85 deg.).
3. Dielectric strength: AC4000V
4. Class X1/Y1 capacitors which are certified by UL/CSA/VDE/BSI/SEMKO/DEMKO/FIMKO/NEMKO/ESTI/IMQ.
5. Possible to use with a component in appliance requiring reinforced insulation and double insulation based on UL1492, IEC60065 and IEC60950.
6. Coated with flame-retardant epoxy resin (conforming to UL94V-0 standard).
7. Cost-saving automatic insertion available.

#### ■ Applications

1. Ideal for use as X/Y capacitors for AC line filter and primary-secondary coupling on switching power supplies and AC adapters.
2. Ideal for use on D-A isolation and noise absorption for DAA modems without transformers.

Do not use these products in any Automotive Power train or Safety equipment including Battery charger for Electric Vehicles and Plug-in Hybrid. Only Murata products clearly stipulated as "for Automotive use" on its catalog can be used for automobile applications such as Power train and Safety equipment.

\*: Small sized Type KX differs from current Type KX in electrical characteristics, such as the voltage dependency, of capacitance temperature dependency, and Dielectric strength.

Therefore, before replacing current Type KX, please make a performance check by equipment. Please refer below too.

[Notice(Rating)

item 2. "Performance Check by Equipment".]

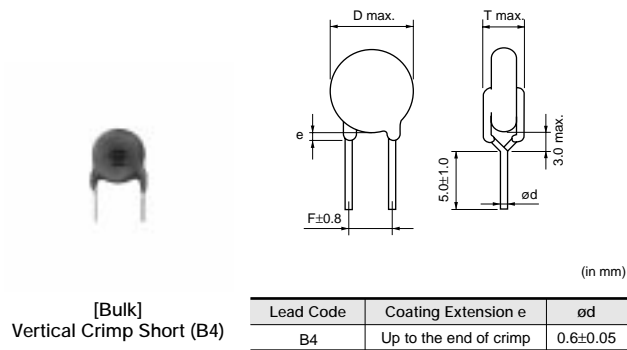
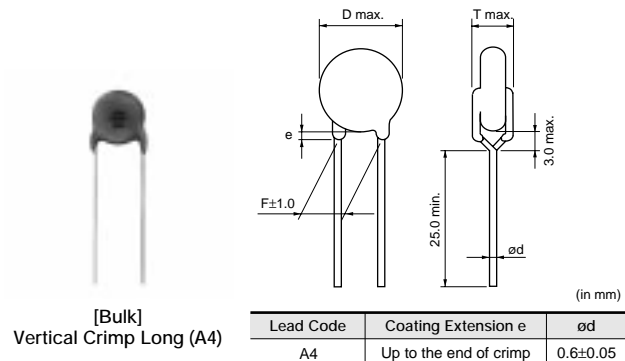

△Note • This PDF catalog is downloaded from the website of Murata Manufacturing co., Ltd. Therefore, it's specifications are subject to change or our products in it may be discontinued without advance notice. Please check with our sales representatives or product engineers before ordering.  
 • This PDF catalog has only typical specifications because there is no space for detailed specifications. Therefore, please approve our product specifications or transact the approval sheet for product specifications before ordering.

■ Standard Certification

	Standard No.	Certified No.	Rated Voltage
UL	UL1414	E37921	AC250V(r.m.s.)
CSA	E384-14	1343810	
VDE	IEC 60384-14 EN 60384-14	40002831	
BSI	EN 60065 (8.8, 14.2)	KM 37901	
	IEC 60384-14		
	EN 60384-14		
SEMKO	IEC 60384-14 EN 60384-14	812158	
DEMKO		314577	
FIMKO		24191	
NEMKO		P08209173	
ESTI		08.0707	
IMQ		EN 60384-14	V4069

- The certification number might change by the revision of the application standard and the change within the range of acquisition.
- Please contact us when the certification of Chinese Safety Standard or South Korean Safety Standard is necessary.

■ Marking

Example	Item
	① Type Designation KX
	② Nominal Capacitance (Marked with 3 figures)
	③ Capacitance Tolerance
	④ Company Name Code ☉ : Made in Taiwan ☉15 : Made in Thailand
	⑤ Manufactured Date Code
	Class Code X1Y1 Rated Voltage Mark 250~

3

Part Number	AC Rated Voltage (Vac)	Temp. Char.	Capacitance (pF)	Body Dia. D (mm)	Lead Spacing F (mm)	Body Thickness T (mm)	Lead Package Long Bulk	Lead Package Short Bulk	Lead Package Taping (1)
DE1B3KX101K□□□L01	250	B	100 ±10%	8 max.	10.0	7.0 max.	A4B	B4B	N4A
DE1B3KX151K□□□L01	250	B	150 ±10%	8 max.	10.0	7.0 max.	A4B	B4B	N4A
DE1B3KX221K□□□L01	250	B	220 ±10%	8 max.	10.0	7.0 max.	A4B	B4B	N4A
DE1B3KX331K□□□L01	250	B	330 ±10%	8 max.	10.0	7.0 max.	A4B	B4B	N4A
DE1B3KX471K□□□L01	250	B	470 ±10%	8 max.	10.0	7.0 max.	A4B	B4B	N4A
DE1B3KX681K□□□L01	250	B	680 ±10%	9 max.	10.0	7.0 max.	A4B	B4B	N4A
DE1E3KX102M□□□L01	250	E	1000 ±20%	7 max.	10.0	7.0 max.	A4B	B4B	N4A
DE1E3KX152M□□□L01	250	E	1500 ±20%	8 max.	10.0	7.0 max.	A4B	B4B	N4A
DE1E3KX222M□□□L01	250	E	2200 ±20%	9 max.	10.0	7.0 max.	A4B	B4B	N4A
DE1E3KX332M□□□L01	250	E	3300 ±20%	10 max.	10.0	7.0 max.	A4B	B4B	N4A
DE1E3KX472M□□□L01	250	E	4700 ±20%	12 max.	10.0	7.0 max.	A4B	B4B	N4A

Three blank columns are filled with the lead and packaging codes. Please refer to the 3 columns on the right for the appropriate code.  
 Murata part numbers might be changed depending on lead code or any other changes. Therefore, please specify only the type name (KX) and capacitance of products in the parts list when it is required for applying safety standard of electric equipment.

# Safety Certified Ceramic Capacitors/High Voltage Ceramic Capacitors



## Type KX (Reinforced Insulation) -IEC60384-14 Class X1, Y1-

4

### ■ Features

1. Operating temperature range guaranteed up to 125 degrees (UL: 85 deg.).
2. Dielectric strength: AC4000V
3. Class X1/Y1 capacitors which are certified by UL/CSA/VDE/BSI/SEMKO/DEMKO/FIMKO/NEMKO/ESTI/IMQ.
4. Possible to use with a component in appliance requiring reinforced insulation and double insulation based on UL1492, IEC60065 and IEC60950.
5. Coated with flame-retardant epoxy resin (conforming to UL94V-0 standard).
6. Cost-saving automatic insertion available.

### ■ Applications

Ideal for use as X/Y capacitors for AC line filter and primary-secondary coupling on switching power supplies and AC adapters.

Do not use these products in any Automotive Power train or Safety equipment including Battery charger for Electric Vehicles and Plug-in Hybrid. Only Murata products clearly stipulated as "for Automotive use" on its catalog can be used for automobile applications such as Power train and Safety equipment.

### ■ Standard Certification

	Standard No.	Certified No.	Rated Voltage
UL	UL1414	E37921	AC250V(r.m.s.)
CSA	E384-14	1343810	
VDE	IEC 60384-14	40002831	
	EN 60384-14		
BSI	EN 60065 (8.8, 14.2)	KM 37901	
	IEC 60384-14		
	EN 60384-14		
SEMKO		812158	
DEMKO	IEC 60384-14	314577	
FIMKO	EN 60384-14	24191	
NEMKO		P08209173	
ESTI		08.0707	
IMQ	EN 60384-14	V4069	

- The certification number might change by the revision of the application standard and the change within the range of acquisition.
- Please contact us when the certification of Chinese Safety Standard or South Korean Safety Standard is necessary.

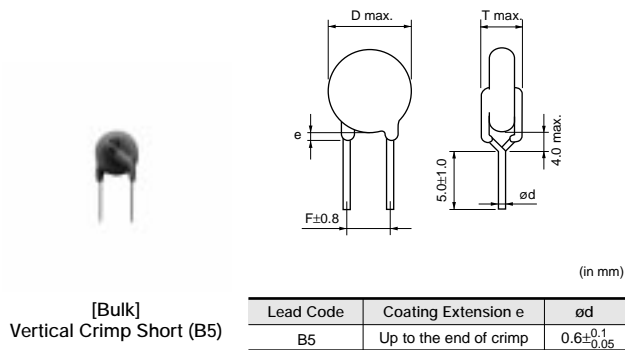
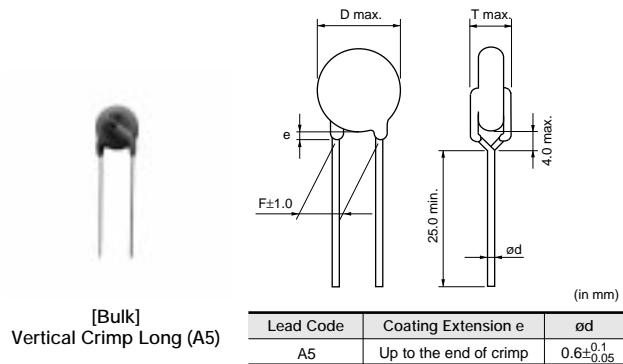

### ■ Marking

Example	Item
	① Type Designation KX
	② Nominal Capacitance (Under 100pF: Actual value, 100pF and over: Marked with 3 figures)
	③ Capacitance Tolerance
	④ Company Name Code C <sub>T</sub> : Made in Taiwan C <sub>T</sub> 15: Made in Thailand
	⑤ Manufactured Date Code
	UL Approval Mark
	CSA Approval Mark
	VDE Approval Mark
	BSI Approval Mark
	SEMKO Approval Mark
DEMKO Approval Mark	
FIMKO Approval Mark	
NEMKO Approval Mark	
ESTI Approval Mark	
IMQ Approval Mark	
Class Code	X1Y1
Rated Voltage Mark	250~

△Note • This PDF catalog is downloaded from the website of Murata Manufacturing co., Ltd. Therefore, it's specifications are subject to change or our products in it may be discontinued without advance notice. Please check with our sales representatives or product engineers before ordering.  
 • This PDF catalog has only typical specifications because there is no space for detailed specifications. Therefore, please approve our product specifications or transact the approval sheet for product specifications before ordering.

Part Number	AC Rated Voltage (Vac)	Temp. Char.	Capacitance (pF)	Body Dia. D (mm)	Lead Spacing F (mm)	Body Thickness T (mm)	Lead Package Long Bulk	Lead Package Short Bulk	Lead Package Taping (1)
DE11XKX100J□□□	250	SL	10 ±5%	9 max.	10.0	8.0 max.	A5B	B5B	N5A
DE11XKX150J□□□	250	SL	15 ±5%	9 max.	10.0	8.0 max.	A5B	B5B	N5A
DE11XKX220J□□□	250	SL	22 ±5%	9 max.	10.0	8.0 max.	A5B	B5B	N5A
DE11XKX330J□□□	250	SL	33 ±5%	9 max.	10.0	8.0 max.	A5B	B5B	N5A
DE11XKX470J□□□	250	SL	47 ±5%	9 max.	10.0	8.0 max.	A5B	B5B	N5A
DE11XKX680J□□□	250	SL	68 ±5%	9 max.	10.0	8.0 max.	A5B	B5B	N5A
DE1B3KX101K□□□	250	B	100 ±10%	9 max.	10.0	8.0 max.	A5B	B5B	N5A
DE1B3KX151K□□□	250	B	150 ±10%	9 max.	10.0	8.0 max.	A5B	B5B	N5A
DE1B3KX221K□□□	250	B	220 ±10%	9 max.	10.0	8.0 max.	A5B	B5B	N5A
DE1B3KX331K□□□	250	B	330 ±10%	9 max.	10.0	8.0 max.	A5B	B5B	N5A
DE1B3KX471K□□□	250	B	470 ±10%	9 max.	10.0	8.0 max.	A5B	B5B	N5A
DE1B3KX681K□□□	250	B	680 ±10%	10 max.	10.0	8.0 max.	A5B	B5B	N5A
DE1E3KX102M□□□A01	250	E	1000 ±20%	8 max.	10.0	8.0 max.	A5B	B5B	N5A
DE1E3KX152M□□□A01	250	E	1500 ±20%	9 max.	10.0	8.0 max.	A5B	B5B	N5A
DE1E3KX222M□□□A01	250	E	2200 ±20%	10 max.	10.0	8.0 max.	A5B	B5B	N5A
DE1E3KX332M□□□A01	250	E	3300 ±20%	12 max.	10.0	8.0 max.	A5B	B5B	N5A
DE1E3KX392M□□□A01	250	E	3900 ±20%	13 max.	10.0	8.0 max.	A5B	B5B	N5A
DE1E3KX472M□□□A01	250	E	4700 ±20%	15 max.	10.0	8.0 max.	A5B	B5B	N5A

Three blank columns are filled with the lead and packaging codes. Please refer to the 3 columns on the right for the appropriate code.  
 Murata part numbers might be changed depending on lead code or any other changes. Therefore, please specify only the type name (KX) and capacitance of products in the parts list when it is required for applying safety standard of electric equipment.

## Type KY/KH/KX Specifications and Test Methods

### ■ Apply to Type KY/KH/KX

Operating Temperature Range: -25 to +125°C (-25 to +85°C in case of the standard of UL)

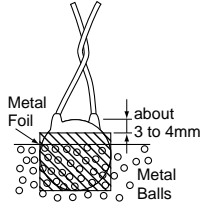
No.	Item	Specifications	Test Method																								
1	Appearance and Dimensions	No marked defect on appearance form and dimensions are within specified range.	The capacitor should be visually inspected for evidence of defect. Dimensions should be measured with slide calipers.																								
2	Marking	To be easily legible	The capacitor should be visually inspected.																								
3	Capacitance	Within specified tolerance																									
4	Dissipation Factor (D.F.) Q	<table border="1"> <thead> <tr> <th>Char.</th> <th>Specifications</th> </tr> </thead> <tbody> <tr> <td>B, E</td> <td>D.F. ≤ 2.5%</td> </tr> <tr> <td>F</td> <td>D.F. ≤ 5.0%</td> </tr> <tr> <td>SL</td> <td>Q ≥ 400+20C*<sup>1</sup> (C &lt; 30pF) Q ≥ 1000 (C ≥ 30pF)</td> </tr> </tbody> </table>	Char.	Specifications	B, E	D.F. ≤ 2.5%	F	D.F. ≤ 5.0%	SL	Q ≥ 400+20C* <sup>1</sup> (C < 30pF) Q ≥ 1000 (C ≥ 30pF)	The capacitance, dissipation factor and Q should be measured at 20°C with 1±0.1kHz (char. SL: 1±0.1MHz) and AC5V(r.m.s.) max.																
Char.	Specifications																										
B, E	D.F. ≤ 2.5%																										
F	D.F. ≤ 5.0%																										
SL	Q ≥ 400+20C* <sup>1</sup> (C < 30pF) Q ≥ 1000 (C ≥ 30pF)																										
5	Insulation Resistance (I.R.)	10000MΩ min.	The insulation resistance should be measured with DC500±50V within 60±5 sec. of charging. The voltage should be applied to the capacitor through a resistor of 1MΩ.																								
6	Between Lead Wires	No failure	The capacitor should not be damaged when test voltages of Table 1 are applied between the lead wires for 60 sec. <Table 1> <table border="1"> <thead> <tr> <th>Type</th> <th>Test Voltage</th> </tr> </thead> <tbody> <tr> <td>KY</td> <td>In case of lead spacing F=5mm AC2000V(r.m.s.) In case of lead spacing F=7.5mm AC2600V(r.m.s.)</td> </tr> <tr> <td>KH</td> <td>AC2600V(r.m.s.)</td> </tr> <tr> <td>KX</td> <td>AC4000V(r.m.s.)</td> </tr> </tbody> </table>	Type	Test Voltage	KY	In case of lead spacing F=5mm AC2000V(r.m.s.) In case of lead spacing F=7.5mm AC2600V(r.m.s.)	KH	AC2600V(r.m.s.)	KX	AC4000V(r.m.s.)																
	Type	Test Voltage																									
KY	In case of lead spacing F=5mm AC2000V(r.m.s.) In case of lead spacing F=7.5mm AC2600V(r.m.s.)																										
KH	AC2600V(r.m.s.)																										
KX	AC4000V(r.m.s.)																										
Body Insulation	No failure	First, the terminals of the capacitor should be connected together. Then, as shown in figure at right, a metal foil should be closely wrapped around the body of the capacitor to the distance of about 3 to 4mm from each terminal. Then, the capacitor should be inserted into a container filled with metal balls of about 1mm diameter. Finally, AC voltage of Table 2 is applied for 60 sec. between the capacitor lead wires and metal balls. <Table 2> <table border="1"> <thead> <tr> <th>Type</th> <th>Test Voltage</th> </tr> </thead> <tbody> <tr> <td>KY</td> <td>AC2600V(r.m.s.)</td> </tr> <tr> <td>KH</td> <td>AC2600V(r.m.s.)</td> </tr> <tr> <td>KX</td> <td>AC4000V(r.m.s.)</td> </tr> </tbody> </table> 	Type	Test Voltage	KY	AC2600V(r.m.s.)	KH	AC2600V(r.m.s.)	KX	AC4000V(r.m.s.)																	
Type	Test Voltage																										
KY	AC2600V(r.m.s.)																										
KH	AC2600V(r.m.s.)																										
KX	AC4000V(r.m.s.)																										
7	Temperature Characteristics	<table border="1"> <thead> <tr> <th>Char.</th> <th>Capacitance Change</th> </tr> </thead> <tbody> <tr> <td>B</td> <td>Within ±10%</td> </tr> <tr> <td>E</td> <td>Within <math>\pm\frac{20}{55}\%</math></td> </tr> <tr> <td>F</td> <td>Within <math>\pm\frac{30}{80}\%</math></td> </tr> </tbody> </table> (Temp. range: -25 to +85°C)  <table border="1"> <thead> <tr> <th>Char.</th> <th>Temperature Coefficient</th> </tr> </thead> <tbody> <tr> <td>SL</td> <td>+350 to -1000ppm/°C</td> </tr> </tbody> </table> (Temp. range: +20 to +85°C)	Char.	Capacitance Change	B	Within ±10%	E	Within $\pm\frac{20}{55}\%$	F	Within $\pm\frac{30}{80}\%$	Char.	Temperature Coefficient	SL	+350 to -1000ppm/°C	The capacitance measurement should be made at each step specified in Table 3. <Table 3> <table border="1"> <thead> <tr> <th>Step</th> <th>Temperature (°C)</th> </tr> </thead> <tbody> <tr> <td>1</td> <td>20±2</td> </tr> <tr> <td>2</td> <td>-25±2</td> </tr> <tr> <td>3</td> <td>20±2</td> </tr> <tr> <td>4</td> <td>85±2</td> </tr> <tr> <td>5</td> <td>20±2</td> </tr> </tbody> </table>	Step	Temperature (°C)	1	20±2	2	-25±2	3	20±2	4	85±2	5	20±2
Char.	Capacitance Change																										
B	Within ±10%																										
E	Within $\pm\frac{20}{55}\%$																										
F	Within $\pm\frac{30}{80}\%$																										
Char.	Temperature Coefficient																										
SL	+350 to -1000ppm/°C																										
Step	Temperature (°C)																										
1	20±2																										
2	-25±2																										
3	20±2																										
4	85±2																										
5	20±2																										
8	Solderability of Leads	Lead wire should be soldered with uniform coating on the axial direction over 3/4 of the circumferential direction.	The lead wire of a capacitor should be dipped into molten solder for 2±0.5 sec. The depth of immersion is up to about 1.5 to 2.0mm from the root of lead wires. Temp. of solder: Lead Free Solder (Sn-3Ag-0.5Cu) 245±5°C H63 Eutectic Solder 235±5°C																								

\*1 "C" expresses nominal capacitance value (pF).

Continued on the following page. 

## Type KY/KH/KX Specifications and Test Methods

Continued from the preceding page.

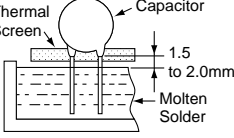
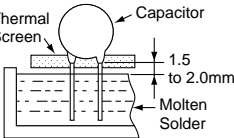
No.	Item	Specifications	Test Method								
9	Soldering Effect (Non-Preheat)	Appearance	No marked defect								
		Capacitance Change	Within $\pm 10\%$								
		I.R.	1000M $\Omega$ min.								
		Dielectric Strength	Per Item 6								
			<p>As shown in figure, the lead wires should be immersed in solder of <math>350\pm 10^\circ\text{C}</math> or <math>260\pm 5^\circ\text{C}</math> up to 1.5 to 2.0mm from the root of terminal for <math>3.5\pm 0.5</math> sec. (<math>10\pm 1</math> sec. for <math>260\pm 5^\circ\text{C}</math>).</p>  <p>Pre-treatment: Capacitor should be stored at <math>85\pm 2^\circ\text{C}</math> for 1 hr., then placed at room condition*<sup>2</sup> for <math>24\pm 2</math> hrs. before initial measurements. Post-treatment: Capacitor should be stored for 1 to 2 hrs. at room condition*<sup>2</sup>.</p>								
10	Soldering Effect (On-Preheat)	Appearance	No marked defect								
		Capacitance Change	Within $\pm 10\%$								
		I.R.	1000M $\Omega$ min.								
		Dielectric Strength	Per Item 6								
			<p>First the capacitor should be stored at <math>120+0/-5^\circ\text{C}</math> for <math>60+0/-5</math> sec. Then, as in figure, the lead wires should be immersed in solder of <math>260+0/-5^\circ\text{C}</math> up to 1.5 to 2.0mm from the root of terminal for <math>7.5+0/-1</math> sec.</p>  <p>Pre-treatment: Capacitor should be stored at <math>85\pm 2^\circ\text{C}</math> for 1 hr., then placed at room condition*<sup>2</sup> for <math>24\pm 2</math> hrs. before initial measurements. Post-treatment: Capacitor should be stored for 1 to 2 hrs. at room condition*<sup>2</sup>.</p>								
11	Vibration Resistance	Appearance	No marked defect								
		Capacitance	Within the specified tolerance								
		D.F. Q	<table border="1"> <thead> <tr> <th>Char.</th> <th>Specifications</th> </tr> </thead> <tbody> <tr> <td>B, E</td> <td>D.F. <math>\leq 2.5\%</math></td> </tr> <tr> <td>F</td> <td>D.F. <math>\leq 5.0\%</math></td> </tr> <tr> <td>SL</td> <td><math>Q \geq 400+20C^{**}</math> (C &lt; 30pF) <math>Q \geq 1000</math> (C <math>\geq 30</math>pF)</td> </tr> </tbody> </table>	Char.	Specifications	B, E	D.F. $\leq 2.5\%$	F	D.F. $\leq 5.0\%$	SL	$Q \geq 400+20C^{**}$ (C < 30pF) $Q \geq 1000$ (C $\geq 30$ pF)
Char.	Specifications										
B, E	D.F. $\leq 2.5\%$										
F	D.F. $\leq 5.0\%$										
SL	$Q \geq 400+20C^{**}$ (C < 30pF) $Q \geq 1000$ (C $\geq 30$ pF)										
			<p>The capacitor should be firmly soldered to the supporting lead wire and vibrated at a frequency range of 10 to 55Hz, 1.5mm in total amplitude, with about a 1 minute rate of vibration change from 10Hz to 55Hz and back to 10Hz. Apply for a total of 6 hrs., 2 hrs. each in 3 mutually perpendicular directions.</p>								
12	Humidity (Under Steady State)	Appearance	No marked defect								
		Capacitance Change	<table border="1"> <thead> <tr> <th>Char.</th> <th>Capacitance Change</th> </tr> </thead> <tbody> <tr> <td>B</td> <td>Within <math>\pm 10\%</math></td> </tr> <tr> <td>E, F</td> <td>Within <math>\pm 15\%</math></td> </tr> <tr> <td>SL</td> <td>Within <math>\pm 5\%</math></td> </tr> </tbody> </table>	Char.	Capacitance Change	B	Within $\pm 10\%$	E, F	Within $\pm 15\%$	SL	Within $\pm 5\%$
		Char.	Capacitance Change								
		B	Within $\pm 10\%$								
		E, F	Within $\pm 15\%$								
SL	Within $\pm 5\%$										
D.F. Q	<table border="1"> <thead> <tr> <th>Char.</th> <th>Specifications</th> </tr> </thead> <tbody> <tr> <td>B, E</td> <td>D.F. <math>\leq 5.0\%</math></td> </tr> <tr> <td>F</td> <td>D.F. <math>\leq 7.5\%</math></td> </tr> <tr> <td>SL</td> <td><math>Q \geq 275+5/2C^{**}</math> (C &lt; 30pF) <math>Q \geq 350</math> (C <math>\geq 30</math>pF)</td> </tr> </tbody> </table>	Char.	Specifications	B, E	D.F. $\leq 5.0\%$	F	D.F. $\leq 7.5\%$	SL	$Q \geq 275+5/2C^{**}$ (C < 30pF) $Q \geq 350$ (C $\geq 30$ pF)		
Char.	Specifications										
B, E	D.F. $\leq 5.0\%$										
F	D.F. $\leq 7.5\%$										
SL	$Q \geq 275+5/2C^{**}$ (C < 30pF) $Q \geq 350$ (C $\geq 30$ pF)										
I.R.	3000M $\Omega$ min.										
Dielectric Strength	Per Item 6										
			<p>Set the capacitor for <math>500\pm 12</math> hrs. at <math>40\pm 2^\circ\text{C}</math> in 90 to 95% relative humidity. Post-treatment: Capacitor should be stored for 1 to 2 hrs. at room condition*<sup>2</sup>.</p>								
13	Humidity Loading	Appearance	No marked defect								
		Capacitance Change	<table border="1"> <thead> <tr> <th>Char.</th> <th>Capacitance Change</th> </tr> </thead> <tbody> <tr> <td>B</td> <td>Within <math>\pm 10\%</math></td> </tr> <tr> <td>E, F</td> <td>Within <math>\pm 15\%</math></td> </tr> <tr> <td>SL</td> <td>Within <math>\pm 5\%</math></td> </tr> </tbody> </table>	Char.	Capacitance Change	B	Within $\pm 10\%$	E, F	Within $\pm 15\%$	SL	Within $\pm 5\%$
		Char.	Capacitance Change								
		B	Within $\pm 10\%$								
		E, F	Within $\pm 15\%$								
SL	Within $\pm 5\%$										
D.F. Q	<table border="1"> <thead> <tr> <th>Char.</th> <th>Specifications</th> </tr> </thead> <tbody> <tr> <td>B, E</td> <td>D.F. <math>\leq 5.0\%</math></td> </tr> <tr> <td>F</td> <td>D.F. <math>\leq 7.5\%</math></td> </tr> <tr> <td>SL</td> <td><math>Q \geq 275+5/2C^{**}</math> (C &lt; 30pF) <math>Q \geq 350</math> (C <math>\geq 30</math>pF)</td> </tr> </tbody> </table>	Char.	Specifications	B, E	D.F. $\leq 5.0\%$	F	D.F. $\leq 7.5\%$	SL	$Q \geq 275+5/2C^{**}$ (C < 30pF) $Q \geq 350$ (C $\geq 30$ pF)		
Char.	Specifications										
B, E	D.F. $\leq 5.0\%$										
F	D.F. $\leq 7.5\%$										
SL	$Q \geq 275+5/2C^{**}$ (C < 30pF) $Q \geq 350$ (C $\geq 30$ pF)										
I.R.	3000M $\Omega$ min.										
Dielectric Strength	Per Item 6										
			<p>Apply the rated voltage for <math>500\pm 12</math> hrs. at <math>40\pm 2^\circ\text{C}</math> in 90 to 95% relative humidity. Post-treatment: Capacitor should be stored for 1 to 2 hrs. at room condition*<sup>2</sup>.</p>								

\*1 "C" expresses nominal capacitance value (pF).

\*2 "room condition" Temperature: 15 to 35°C, Relative humidity: 45 to 75%, Atmospheric pressure: 86 to 106kPa

Continued on the following page. 

## Type KY/KH/KX Specifications and Test Methods

Continued from the preceding page.

No.	Item	Specifications	Test Method						
14	Life	<p>Appearance: No marked defect</p> <p>Capacitance Change: Within <math>\pm 20\%</math></p> <p>I.R.: 3000M<math>\Omega</math> min.</p> <p>Dielectric Strength: Per Item 6</p>	<p>Impulse Voltage</p> <p>Each individual capacitor should be subjected to a 5kV (Type KX: 8kV) impulses for three times. After the capacitors are applied to life test.</p> <p>Front time (<math>T_1</math>) = <math>1.2\mu s = 1.67T</math> Time to half-value (<math>T_2</math>) = <math>50\mu s</math></p> <p>Apply a voltage of Table 4 for 1000 hrs. at <math>125 \pm 2/0^\circ C</math>, and relative humidity of 50% max.</p> <p style="text-align: center;">&lt;Table 4&gt;</p> <table border="1" style="margin-left: auto; margin-right: auto;"> <thead> <tr> <th>Applied Voltage</th> </tr> </thead> <tbody> <tr> <td>AC425V(r.m.s.), except that once each hour the voltage is increased to AC1000V(r.m.s.) for 0.1 sec.</td> </tr> </tbody> </table> <p>Post-treatment: Capacitor should be stored for 1 to 2 hrs. at room condition*2.</p>	Applied Voltage	AC425V(r.m.s.), except that once each hour the voltage is increased to AC1000V(r.m.s.) for 0.1 sec.				
	Applied Voltage								
	AC425V(r.m.s.), except that once each hour the voltage is increased to AC1000V(r.m.s.) for 0.1 sec.								
15	Flame Test	<p>The capacitor flame discontinues as follows.</p> <table border="1" style="margin-left: auto; margin-right: auto;"> <thead> <tr> <th>Cycle</th> <th>Time (sec.)</th> </tr> </thead> <tbody> <tr> <td>1 to 4</td> <td>30 max.</td> </tr> <tr> <td>5</td> <td>60 max.</td> </tr> </tbody> </table>	Cycle	Time (sec.)	1 to 4	30 max.	5	60 max.	<p>The capacitor should be subjected to applied flame for 15 sec. and then removed for 15 sec. until 5 cycles are completed.</p>
Cycle	Time (sec.)								
1 to 4	30 max.								
5	60 max.								
16	Robustness of Terminations	<p>Tensile: Lead wire should not be cut off. Capacitor should not be broken.</p> <p>Bending: Each lead wire should be subjected to 5N weight and then a 90° bend, at the point of egress, in one direction, return to original position, and then apply a 90° bend in the opposite direction at the rate of one bend in 2 to 3 sec.</p>							
	17	Active Flammability	<p>The cheese-cloth should not be on fire.</p>	<p>The capacitor should be individually wrapped in at least one but not more than two complete layers of cheesecloth. The capacitor should be subjected to 20 discharges. The interval between successive discharges should be 5 sec. The UAC should be maintained for 2 min. after the last discharge.</p> <p> <math>C_{1,2}</math> : <math>1\mu F \pm 10\%</math>      <math>C_3</math> : <math>0.033\mu F \pm 5\%</math> 10kV  <math>L_{1 \text{ to } 4}</math> : <math>1.5mH \pm 20\%</math> 16A Rod core choke  <math>C_t</math> : <math>3\mu F \pm 5\%</math> 10kV      R : <math>100\Omega \pm 2\%</math>  <math>C_x</math> : Capacitor under test      UAC : <math>U_R \pm 5\%</math>              F : Fuse, Rated 10A      <math>U_R</math> : Rated Voltage  <math>U_t</math> : Voltage applied to <math>C_t</math> </p>					

\*2 "room condition" Temperature: 15 to 35°C, Relative humidity: 45 to 75%, Atmospheric pressure: 86 to 106kPa

Continued on the following page.

## Type KY/KH/KX Specifications and Test Methods

Continued from the preceding page.

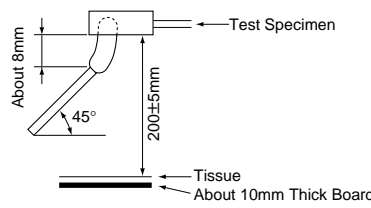
No.	Item	Specifications	Test Method																																																					
18	Passive Flammability	The burning time should not exceed 30 sec. The tissue paper should not ignite.	<p>The capacitor under test should be held in the flame in the position which best promotes burning. Each specimen should only be exposed once to the flame. Time of exposure to flame: 30 sec.</p> <p style="margin-left: 40px;">Length of flame : 12±1mm                      Gas burner : Length 35mm min.                                        : Inside Dia. 0.5±0.1mm                                        : Outside Dia. 0.9mm max.                      Gas : Butane gas Purity 95% min.</p> 																																																					
19	Temperature and Immersion Cycle	<table border="1" style="width: 100%; border-collapse: collapse;"> <tr> <td style="width: 15%;">Appearance</td> <td>No marked defect</td> </tr> <tr> <td style="width: 15%;">Capacitance Change</td> <td> <table border="1" style="width: 100%; border-collapse: collapse;"> <tr> <th style="width: 10%;">Char.</th> <th style="width: 90%;">Capacitance Change</th> </tr> <tr> <td>B</td> <td>Within ±10%</td> </tr> <tr> <td>E, F</td> <td>Within ±20%</td> </tr> <tr> <td>SL</td> <td>Within ± 5%</td> </tr> </table> </td> </tr> <tr> <td style="width: 15%;">D.F. Q</td> <td> <table border="1" style="width: 100%; border-collapse: collapse;"> <tr> <th style="width: 10%;">Char.</th> <th style="width: 90%;">Specifications</th> </tr> <tr> <td>B, E</td> <td>D.F. ≤5.0%</td> </tr> <tr> <td>F</td> <td>D.F. ≤7.5%</td> </tr> <tr> <td>SL</td> <td>Q ≥ 275+5/2C** (C &lt; 30pF) Q ≥ 350 (C ≥ 30pF)</td> </tr> </table> </td> </tr> <tr> <td style="width: 15%;">I.R.</td> <td>3000MΩ min.</td> </tr> <tr> <td style="width: 15%;">Dielectric Strength</td> <td>Per Item 6</td> </tr> </table>	Appearance	No marked defect	Capacitance Change	<table border="1" style="width: 100%; border-collapse: collapse;"> <tr> <th style="width: 10%;">Char.</th> <th style="width: 90%;">Capacitance Change</th> </tr> <tr> <td>B</td> <td>Within ±10%</td> </tr> <tr> <td>E, F</td> <td>Within ±20%</td> </tr> <tr> <td>SL</td> <td>Within ± 5%</td> </tr> </table>	Char.	Capacitance Change	B	Within ±10%	E, F	Within ±20%	SL	Within ± 5%	D.F. Q	<table border="1" style="width: 100%; border-collapse: collapse;"> <tr> <th style="width: 10%;">Char.</th> <th style="width: 90%;">Specifications</th> </tr> <tr> <td>B, E</td> <td>D.F. ≤5.0%</td> </tr> <tr> <td>F</td> <td>D.F. ≤7.5%</td> </tr> <tr> <td>SL</td> <td>Q ≥ 275+5/2C** (C &lt; 30pF) Q ≥ 350 (C ≥ 30pF)</td> </tr> </table>	Char.	Specifications	B, E	D.F. ≤5.0%	F	D.F. ≤7.5%	SL	Q ≥ 275+5/2C** (C < 30pF) Q ≥ 350 (C ≥ 30pF)	I.R.	3000MΩ min.	Dielectric Strength	Per Item 6	<p>The capacitor should be subjected to 5 temperature cycles, then consecutively to 2 immersion cycles.</p> <p style="text-align: center;">&lt;Temperature Cycle&gt;</p> <table border="1" style="width: 100%; border-collapse: collapse;"> <thead> <tr> <th style="width: 10%;">Step</th> <th style="width: 60%;">Temperature (°C)</th> <th style="width: 30%;">Time (min)</th> </tr> </thead> <tbody> <tr> <td style="text-align: center;">1</td> <td style="text-align: center;">-25+0/-3</td> <td style="text-align: center;">30</td> </tr> <tr> <td style="text-align: center;">2</td> <td style="text-align: center;">Room temp.</td> <td style="text-align: center;">3</td> </tr> <tr> <td style="text-align: center;">3</td> <td style="text-align: center;">125+3/-0</td> <td style="text-align: center;">30</td> </tr> <tr> <td style="text-align: center;">4</td> <td style="text-align: center;">Room temp.</td> <td style="text-align: center;">3</td> </tr> </tbody> </table> <p style="text-align: right;">Cycle time: 5 cycle</p> <p style="text-align: center;">&lt;Immersion Cycle&gt;</p> <table border="1" style="width: 100%; border-collapse: collapse;"> <thead> <tr> <th style="width: 10%;">Step</th> <th style="width: 40%;">Temperature (°C)</th> <th style="width: 15%;">Time (min)</th> <th style="width: 35%;">Immersion Water</th> </tr> </thead> <tbody> <tr> <td style="text-align: center;">1</td> <td style="text-align: center;">65+5/-0</td> <td style="text-align: center;">15</td> <td style="text-align: center;">Clean water</td> </tr> <tr> <td style="text-align: center;">2</td> <td style="text-align: center;">0±3</td> <td style="text-align: center;">15</td> <td style="text-align: center;">Salt water</td> </tr> </tbody> </table> <p style="text-align: right;">Cycle time: 2 cycle</p> <p>Pre-treatment: Capacitor should be stored at 85±2°C for 1 hr., then placed at room condition*2 for 24±2 hrs.</p> <p>Post-treatment: Capacitor should be stored for 24±2 hrs. at room condition*2.</p>	Step	Temperature (°C)	Time (min)	1	-25+0/-3	30	2	Room temp.	3	3	125+3/-0	30	4	Room temp.	3	Step	Temperature (°C)	Time (min)	Immersion Water	1	65+5/-0	15	Clean water	2	0±3	15	Salt water
Appearance	No marked defect																																																							
Capacitance Change	<table border="1" style="width: 100%; border-collapse: collapse;"> <tr> <th style="width: 10%;">Char.</th> <th style="width: 90%;">Capacitance Change</th> </tr> <tr> <td>B</td> <td>Within ±10%</td> </tr> <tr> <td>E, F</td> <td>Within ±20%</td> </tr> <tr> <td>SL</td> <td>Within ± 5%</td> </tr> </table>	Char.	Capacitance Change	B	Within ±10%	E, F	Within ±20%	SL	Within ± 5%																																															
Char.	Capacitance Change																																																							
B	Within ±10%																																																							
E, F	Within ±20%																																																							
SL	Within ± 5%																																																							
D.F. Q	<table border="1" style="width: 100%; border-collapse: collapse;"> <tr> <th style="width: 10%;">Char.</th> <th style="width: 90%;">Specifications</th> </tr> <tr> <td>B, E</td> <td>D.F. ≤5.0%</td> </tr> <tr> <td>F</td> <td>D.F. ≤7.5%</td> </tr> <tr> <td>SL</td> <td>Q ≥ 275+5/2C** (C &lt; 30pF) Q ≥ 350 (C ≥ 30pF)</td> </tr> </table>	Char.	Specifications	B, E	D.F. ≤5.0%	F	D.F. ≤7.5%	SL	Q ≥ 275+5/2C** (C < 30pF) Q ≥ 350 (C ≥ 30pF)																																															
Char.	Specifications																																																							
B, E	D.F. ≤5.0%																																																							
F	D.F. ≤7.5%																																																							
SL	Q ≥ 275+5/2C** (C < 30pF) Q ≥ 350 (C ≥ 30pF)																																																							
I.R.	3000MΩ min.																																																							
Dielectric Strength	Per Item 6																																																							
Step	Temperature (°C)	Time (min)																																																						
1	-25+0/-3	30																																																						
2	Room temp.	3																																																						
3	125+3/-0	30																																																						
4	Room temp.	3																																																						
Step	Temperature (°C)	Time (min)	Immersion Water																																																					
1	65+5/-0	15	Clean water																																																					
2	0±3	15	Salt water																																																					

\*1 "C" expresses nominal capacitance value (pF).

\*2 "room condition" Temperature: 15 to 35°C, Relative humidity: 45 to 75%, Atmospheric pressure: 86 to 106kPa

# Safety Certified Ceramic Capacitors/High Voltage Ceramic Capacitors



## DEJ Series -Based on the Electrical Appliance and Material Safety Law of Japan-

### ■ Features

1. Coated with flame-retardant epoxy resin (conforming to UL94V-0 standard).
2. Cost-saving automatic insertion available.
3. This type is based on the electrical appliance and material safety law of Japan (separated table 4).

### ■ Applications

Ideal for use on AC line filter and primary-secondary coupling for switching power supplies and AC adapters.

Do not use these products in any Automotive Power train or Safety equipment including Battery charger for Electric Vehicles and Plug-in Hybrid. Only Murata products clearly stipulated as "for Automotive use" on its catalog can be used for automobile applications such as Power train and Safety equipment.

### ■ Marking

Temp. Char.		E, F
Nominal Body Diameter	ø7-8mm	102Z 250~ 65
	ø9-11mm	332Z 250~ 65
Nominal Capacitance		Marked with 3 figures
Capacitance Tolerance		Marked with code
Rated Voltage		Marked with code
Manufacturer's Identification		Marked with  (omitted for nominal body diameter ø8mm and under)
Manufactured Date Code		Abbreviation

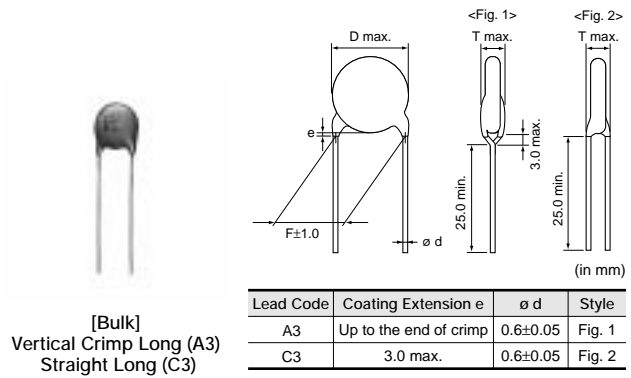

[Bulk]  
Vertical Crimp Long (A3)  
Straight Long (C3)

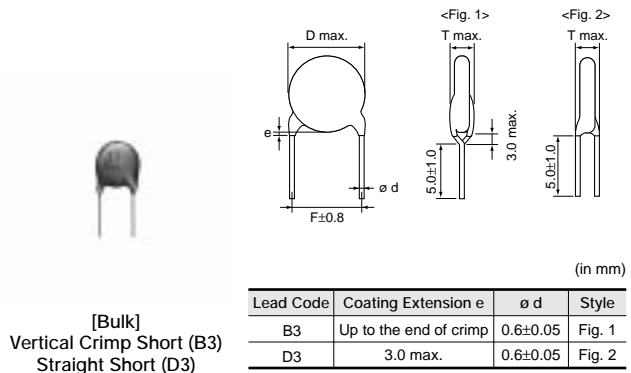

[Bulk]  
Vertical Crimp Short (B3)  
Straight Short (D3)

Part Number	AC Rated Voltage (Vac)	Temp. Char.	Capacitance (pF)	Body Dia. D (mm)	Lead Spacing F (mm)	Body Thickness T (mm)	Lead Package Long Bulk	Lead Package Short Bulk	Lead Package Taping (1)	Lead Package Taping (2)
DEJE3E2102Z□□□	250	E	1000 +80/-20%	7 max.	7.5	4.0 max.	C3B	D3B	N2A	P3A
DEJE3E2222Z□□□	250	E	2200 +80/-20%	8 max.	7.5	4.0 max.	A3B	B3B	N2A	N3A
DEJE3E2332Z□□□	250	E	3300 +80/-20%	9 max.	7.5	4.0 max.	A3B	B3B	N2A	N3A
DEJE3E2472Z□□□	250	E	4700 +80/-20%	11 max.	7.5	4.0 max.	A3B	B3B	N2A	N3A
DEJF3E2472Z□□□	250	F	4700 +80/-20%	8 max.	7.5	4.0 max.	A3B	B3B	N2A	N3A
DEJF3E2103Z□□□	250	F	10000 +80/-20%	11 max.	7.5	4.0 max.	A3B	B3B	N2A	N3A

Three blank columns are filled with the lead and packaging codes. Please refer to the 3 columns on the right for the appropriate code.  
 Taping (1): Lead spacing F=5.0mm, Taping (2): Lead spacing F=7.5mm.

## DEJ Series Specifications and Test Methods

■ Apply to DEJ Series (Products which are based on the electrical appliance and material safety law of Japan)

Operating Temperature Range: -25 to +85°C

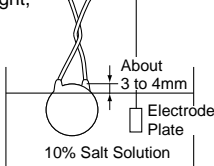
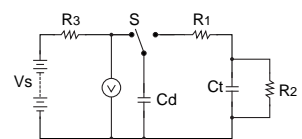
No.	Item	Specifications	Test Method																		
1	Appearance and Dimensions	No marked defect on appearance form and dimensions are within specified range.	The capacitor should be visually inspected for evidence of defect. Dimensions should be measured with slide calipers.																		
2	Marking	To be easily legible	The capacitor should be visually inspected.																		
3	Capacitance	Within specified tolerance	The capacitance should be measured at 20°C with 1±0.1kHz and AC5V(r.m.s.) max.																		
4	Dissipation Factor (D.F.)	<table border="1" style="width: 100%; border-collapse: collapse; margin-bottom: 5px;"> <thead> <tr style="background-color: #f2f2f2;"> <th style="width: 15%;">Char.</th> <th style="width: 85%;">Specifications</th> </tr> </thead> <tbody> <tr> <td>E</td> <td>D.F. ≤ 2.5%</td> </tr> <tr> <td>F</td> <td>D.F. ≤ 5.0%</td> </tr> </tbody> </table>	Char.	Specifications	E	D.F. ≤ 2.5%	F	D.F. ≤ 5.0%	The dissipation factor should be measured at 20°C with 1±0.1kHz and AC5V(r.m.s.) max.												
Char.	Specifications																				
E	D.F. ≤ 2.5%																				
F	D.F. ≤ 5.0%																				
5	Insulation Resistance (I.R.)	10000MΩ min.	The insulation resistance should be measured with DC500±50V within 60±5 sec. of charging.																		
6	Dielectric Strength	Between Lead Wires	No failure  The capacitor should not be damaged when AC1500V(r.m.s.) are applied between the lead wires for 60 sec.																		
		Body Insulation	No failure  First, the terminals of the capacitor should be connected together. Then, as shown in figure at right, the capacitor should be immersed into 10% salt solution up to a position of about 3 to 4mm apart from the terminals. Finally, AC1500V(r.m.s.) is applied for 60 sec. between the capacitor lead wires and electrode plate. 																		
7	Temperature Characteristics	<table border="1" style="width: 100%; border-collapse: collapse; margin-bottom: 5px;"> <thead> <tr style="background-color: #f2f2f2;"> <th style="width: 15%;">Char.</th> <th style="width: 85%;">Capacitance Change</th> </tr> </thead> <tbody> <tr> <td>E</td> <td>Within +20% -55%</td> </tr> <tr> <td>F</td> <td>Within +30% -80%</td> </tr> </tbody> </table>	Char.	Capacitance Change	E	Within +20% -55%	F	Within +30% -80%	The capacitance measurement should be made at each step specified in Table 1. <div style="text-align: center;"> <table border="1" style="width: 100%; border-collapse: collapse; margin: 0 auto;"> <caption>&lt;Table 1&gt;</caption> <thead> <tr style="background-color: #f2f2f2;"> <th style="width: 15%;">Step</th> <th style="width: 85%;">Temperature (°C)</th> </tr> </thead> <tbody> <tr><td>1</td><td>20±2</td></tr> <tr><td>2</td><td>-25±2</td></tr> <tr><td>3</td><td>20±2</td></tr> <tr><td>4</td><td>85±2</td></tr> <tr><td>5</td><td>20±2</td></tr> </tbody> </table> </div>	Step	Temperature (°C)	1	20±2	2	-25±2	3	20±2	4	85±2	5	20±2
Char.	Capacitance Change																				
E	Within +20% -55%																				
F	Within +30% -80%																				
Step	Temperature (°C)																				
1	20±2																				
2	-25±2																				
3	20±2																				
4	85±2																				
5	20±2																				
8	Discharge Test	Appearance	No marked defect																		
		I.R.	1000MΩ min.																		
		Dielectric Strength	Per Item 6																		
			As in Figure 1, discharge is made 50 times at 5 sec. intervals from the capacitor (Cd) charged at DC voltage of specified.  Fig.1 Ct: Capacitor under test      R2: 100MΩ S: High-voltage switch      R3: Surge resistance R1: 1000Ω <table border="1" style="width: 100%; border-collapse: collapse; margin-top: 5px;"> <tbody> <tr> <td style="width: 50%;">Cd</td> <td>0.001μF</td> </tr> <tr> <td>Vs</td> <td>DC10kV</td> </tr> </tbody> </table>	Cd	0.001μF	Vs	DC10kV														
Cd	0.001μF																				
Vs	DC10kV																				
9	Solderability of Leads	Lead wire should be soldered with uniform coating on the axial direction over 3/4 of the circumferential direction.	The lead wire of a capacitor should be dipped into molten solder for 2±0.5 sec. The depth of immersion is up to about 1.5 to 2.0mm from the root of lead wires. Temp. of solder: Lead Free Solder (Sn-3Ag-0.5Cu) 245±5°C H63 Eutectic Solder 235±5°C																		

Continued on the following page.

## DEJ Series Specifications and Test Methods

Continued from the preceding page.

No.	Item	Specifications	Test Method						
10	Appearance	No marked defect	As shown in figure, the lead wires should be immersed in solder of 350±10°C up to 1.5 to 2.0mm from the root of terminal for 3.5±0.5 sec. Pre-treatment: Capacitor should be stored at 85±2°C for 1 hr., then placed at room condition*1 for 24±2 hrs. before initial measurements. Post-treatment: Capacitor should be stored for 4 to 24 hrs. at room condition*1.						
	I.R.	1000MΩ min.							
	Dielectric Strength	Per Item 6							
11	Appearance	No marked defect	First the capacitor should be stored at 120+0/-5°C for 60+0/-5 sec. Then, as in figure, the lead wires should be immersed in solder of 260+0/-5°C up to 1.5 to 2.0mm from the root of terminal for 7.5+0/-1 sec. Pre-treatment: Capacitor should be stored at 85±2°C for 1 hr., then placed at room condition*1 for 24±2 hrs. before initial measurements. Post-treatment: Capacitor should be stored for 4 to 24 hrs. at room condition*1.						
	I.R.	1000MΩ min.							
	Dielectric Strength	Per Item 6							
12	Appearance	No marked defect	The capacitor should be firmly soldered to the supporting lead wire and vibrated at a frequency range of 10 to 55Hz, 1.5mm in total amplitude, with about a 1 minute rate of vibration change from 10Hz to 55Hz and back to 10Hz. Apply for a total of 6 hrs., 2 hrs. each in 3 mutually perpendicular directions.						
	Capacitance	Within the specified tolerance							
	D.F.	<table border="1"> <thead> <tr> <th>Char.</th> <th>Specifications</th> </tr> </thead> <tbody> <tr> <td>E</td> <td>D.F. ≤2.5%</td> </tr> <tr> <td>F</td> <td>D.F. ≤5.0%</td> </tr> </tbody> </table>		Char.	Specifications	E	D.F. ≤2.5%	F	D.F. ≤5.0%
Char.	Specifications								
E	D.F. ≤2.5%								
F	D.F. ≤5.0%								
13	Solvent Resistance	Appearance: No marked defect	The capacitor should be immersed into a isopropyl alcohol for 30±5 sec.						
14	Appearance	No marked defect	Set the capacitor for 500±12 hrs. at 40±2°C in 90 to 95% relative humidity. Pre-treatment: Capacitor should be stored at 85±2°C for 1 hr., then placed at room condition*1 for 24±2 hrs. before initial measurements. Post-treatment: Capacitor should be stored for 1 to 2 hrs. at room condition*1.						
	Capacitance Change	<table border="1"> <thead> <tr> <th>Char.</th> <th>Capacitance Change</th> </tr> </thead> <tbody> <tr> <td>E</td> <td>Within ±20%</td> </tr> <tr> <td>F</td> <td>Within ±30%</td> </tr> </tbody> </table>		Char.	Capacitance Change	E	Within ±20%	F	Within ±30%
	Char.	Capacitance Change							
	E	Within ±20%							
	F	Within ±30%							
D.F.	<table border="1"> <thead> <tr> <th>Char.</th> <th>Specifications</th> </tr> </thead> <tbody> <tr> <td>E</td> <td>D.F. ≤5.0%</td> </tr> <tr> <td>F</td> <td>D.F. ≤7.5%</td> </tr> </tbody> </table>	Char.	Specifications	E	D.F. ≤5.0%	F	D.F. ≤7.5%		
Char.	Specifications								
E	D.F. ≤5.0%								
F	D.F. ≤7.5%								
I.R.	1000MΩ min.								
Dielectric Strength	Per Item 6								
15	Appearance	No marked defect	The capacitor should be subjected to 40±2°C, relative humidity of 90 to 98% for 8 hrs., and then removed in room temperature for 16 hrs. until 5 cycles. Pre-treatment: Capacitor should be stored at 85±2°C for 1 hr., then placed at room condition*1 for 24±2 hrs. before initial measurements. Post-treatment: Capacitor should be stored for 1 to 2 hrs. at room condition*1.						
	Capacitance Change	<table border="1"> <thead> <tr> <th>Char.</th> <th>Capacitance Change</th> </tr> </thead> <tbody> <tr> <td>E</td> <td>Within ±20%</td> </tr> <tr> <td>F</td> <td>Within ±30%</td> </tr> </tbody> </table>		Char.	Capacitance Change	E	Within ±20%	F	Within ±30%
	Char.	Capacitance Change							
	E	Within ±20%							
	F	Within ±30%							
D.F.	<table border="1"> <thead> <tr> <th>Char.</th> <th>Specifications</th> </tr> </thead> <tbody> <tr> <td>E</td> <td>D.F. ≤5.0%</td> </tr> <tr> <td>F</td> <td>D.F. ≤7.5%</td> </tr> </tbody> </table>	Char.	Specifications	E	D.F. ≤5.0%	F	D.F. ≤7.5%		
Char.	Specifications								
E	D.F. ≤5.0%								
F	D.F. ≤7.5%								
I.R.	1000MΩ min.								
Dielectric Strength	Per Item 6								

\*1 "room condition" Temperature: 15 to 35°C, Relative humidity: 45 to 75%, Atmospheric pressure: 86 to 106kPa

Continued on the following page. 

## DEJ Series Specifications and Test Methods

Continued from the preceding page.

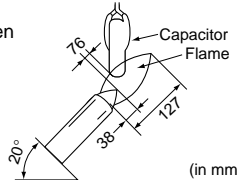
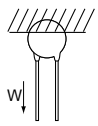
No.	Item	Specifications	Test Method																											
16	Humidity Loading	Appearance	No marked defect																											
		Capacitance Change	<table border="1"> <thead> <tr> <th>Char.</th> <th>Capacitance Change</th> </tr> </thead> <tbody> <tr> <td>E</td> <td>Within ±20%</td> </tr> <tr> <td>F</td> <td>Within ±30%</td> </tr> </tbody> </table>	Char.	Capacitance Change	E	Within ±20%	F	Within ±30%																					
		Char.	Capacitance Change																											
		E	Within ±20%																											
		F	Within ±30%																											
D.F.	<table border="1"> <thead> <tr> <th>Char.</th> <th>Specifications</th> </tr> </thead> <tbody> <tr> <td>E</td> <td>D.F. ≤5.0%</td> </tr> <tr> <td>F</td> <td>D.F. ≤7.5%</td> </tr> </tbody> </table>	Char.	Specifications	E	D.F. ≤5.0%	F	D.F. ≤7.5%																							
Char.	Specifications																													
E	D.F. ≤5.0%																													
F	D.F. ≤7.5%																													
I.R.	1000MΩ min.																													
Dielectric Strength	Per Item 6																													
			Apply the rated voltage for 500±12 hrs. at 40±2°C in 90 to 95% relative humidity. Pre-treatment: Capacitor should be stored at 85±2°C for 1 hr., then placed at room condition*1 for 24±2 hrs. before initial measurements. Post-treatment: Capacitor should be stored for 1 to 2 hrs. at room condition*1.																											
17	Life	Appearance	No marked defect																											
		Capacitance Change	<table border="1"> <thead> <tr> <th>Char.</th> <th>Capacitance Change</th> </tr> </thead> <tbody> <tr> <td>E</td> <td>Within ±20%</td> </tr> <tr> <td>F</td> <td>Within ±30%</td> </tr> </tbody> </table>	Char.	Capacitance Change	E	Within ±20%	F	Within ±30%																					
		Char.	Capacitance Change																											
		E	Within ±20%																											
F	Within ±30%																													
I.R.	1000MΩ min.																													
Dielectric Strength	Per Item 6																													
			Apply a voltage of Table 2 for 1500 hrs. at 85±2°C, relative humidity 50% max. <div style="text-align: center;">                         &lt;Table 2&gt;  <table border="1"> <thead> <tr> <th>Applied Voltage</th> </tr> </thead> <tbody> <tr> <td>AC500V(r.m.s.), except that once each hour the voltage is increased to AC1000V(r.m.s.) for 0.1 sec.</td> </tr> </tbody> </table> </div> Pre-treatment: Capacitor should be stored at 85±2°C for 1 hr., then placed at room condition*1 for 24±2 hrs. before initial measurements. Post-treatment: Capacitor should be stored for 4 to 24 hrs. at room condition*1.	Applied Voltage	AC500V(r.m.s.), except that once each hour the voltage is increased to AC1000V(r.m.s.) for 0.1 sec.																									
Applied Voltage																														
AC500V(r.m.s.), except that once each hour the voltage is increased to AC1000V(r.m.s.) for 0.1 sec.																														
18	Flame Test	The capacitor flame discontinued as follows.	The capacitor should be subjected to applied flame for 15 sec. and then removed for 15 sec. until 3 cycles are completed. <div style="text-align: right;">  </div>																											
		<table border="1"> <thead> <tr> <th>Cycle</th> <th>Time (sec.)</th> </tr> </thead> <tbody> <tr> <td>1 to 2</td> <td>15 max.</td> </tr> <tr> <td>3</td> <td>60 max.</td> </tr> </tbody> </table>		Cycle	Time (sec.)	1 to 2	15 max.	3	60 max.																					
Cycle	Time (sec.)																													
1 to 2	15 max.																													
3	60 max.																													
19	Robustness of Terminations	Tensile	As shown in figure at right, fix the body of capacitor, apply a tensile weight gradually to each lead wire in the radial direction of capacitor up to 10N and keep it for 10±1 sec. <div style="text-align: right;">  </div>																											
		Bending		Each lead wire should be subjected to 5N weight and then a 90° bend, at the point of egress, in one direction, return to original position, and then apply a 90° bend in the opposite direction at the rate of one bend in 2 to 3 sec.																										
20	Temperature and Immersion Cycle	Appearance	No marked defect																											
		Capacitance Change	<table border="1"> <thead> <tr> <th>Char.</th> <th>Capacitance Change</th> </tr> </thead> <tbody> <tr> <td>E</td> <td>Within ±20%</td> </tr> <tr> <td>F</td> <td>Within ±30%</td> </tr> </tbody> </table>	Char.	Capacitance Change	E	Within ±20%	F	Within ±30%																					
		Char.	Capacitance Change																											
		E	Within ±20%																											
		F	Within ±30%																											
D.F.	<table border="1"> <thead> <tr> <th>Char.</th> <th>Specifications</th> </tr> </thead> <tbody> <tr> <td>E</td> <td>D.F. ≤5.0%</td> </tr> <tr> <td>F</td> <td>D.F. ≤7.5%</td> </tr> </tbody> </table>	Char.	Specifications	E	D.F. ≤5.0%	F	D.F. ≤7.5%																							
Char.	Specifications																													
E	D.F. ≤5.0%																													
F	D.F. ≤7.5%																													
I.R.	1000MΩ min.																													
Dielectric Strength	Per Item 6																													
			The capacitor should be subjected to 5 temperature cycles, then consecutively to 2 immersion cycles. <div style="text-align: center;">                         &lt;Temperature Cycle&gt; <table border="1"> <thead> <tr> <th>Step</th> <th>Temperature (°C)</th> <th>Time (min)</th> </tr> </thead> <tbody> <tr> <td>1</td> <td>-25+0/-3</td> <td>30</td> </tr> <tr> <td>2</td> <td>Room temp.</td> <td>3</td> </tr> <tr> <td>3</td> <td>85+3/-0</td> <td>30</td> </tr> <tr> <td>4</td> <td>Room temp.</td> <td>3</td> </tr> </tbody> </table>                         Cycle time: 5 cycle                     </div> <div style="text-align: center;">                         &lt;Immersion Cycle&gt; <table border="1"> <thead> <tr> <th>Step</th> <th>Temperature (°C)</th> <th>Time (min)</th> <th>Immersion Water</th> </tr> </thead> <tbody> <tr> <td>1</td> <td>65+5/-0</td> <td>15</td> <td>Clean water</td> </tr> <tr> <td>2</td> <td>0±3</td> <td>15</td> <td>Salt water</td> </tr> </tbody> </table>                         Cycle time: 2 cycle                     </div> Pre-treatment: Capacitor should be stored at 85±2°C for 1 hr., then placed at room condition*1 for 24±2 hrs. Post-treatment: Capacitor should be stored for 4 to 24 hrs. at room condition*1.	Step	Temperature (°C)	Time (min)	1	-25+0/-3	30	2	Room temp.	3	3	85+3/-0	30	4	Room temp.	3	Step	Temperature (°C)	Time (min)	Immersion Water	1	65+5/-0	15	Clean water	2	0±3	15	Salt water
Step	Temperature (°C)	Time (min)																												
1	-25+0/-3	30																												
2	Room temp.	3																												
3	85+3/-0	30																												
4	Room temp.	3																												
Step	Temperature (°C)	Time (min)	Immersion Water																											
1	65+5/-0	15	Clean water																											
2	0±3	15	Salt water																											

\*1 "room condition" Temperature: 15 to 35°C, Relative humidity: 45 to 75%, Atmospheric pressure: 86 to 106kPa

## Safety Certified Ceramic Capacitors Characteristics Data (Typical Example)

### Capacitance - Temperature Characteristics

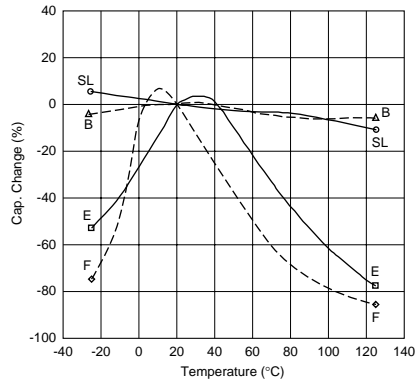

### Insertion Loss - Frequency Characteristics

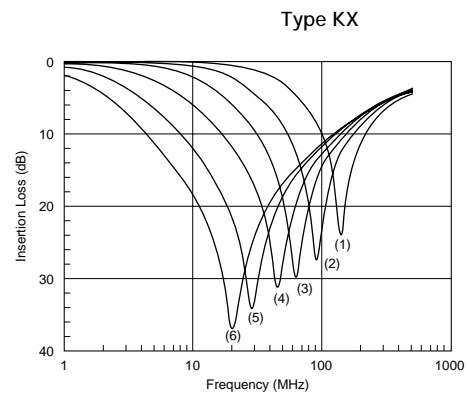
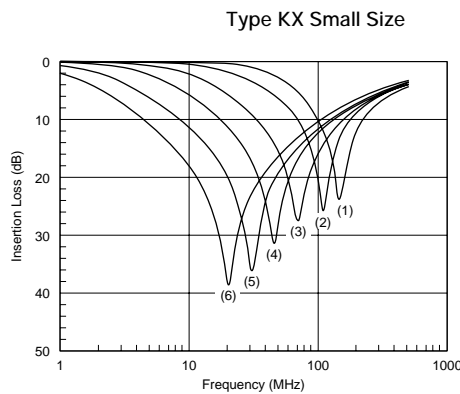
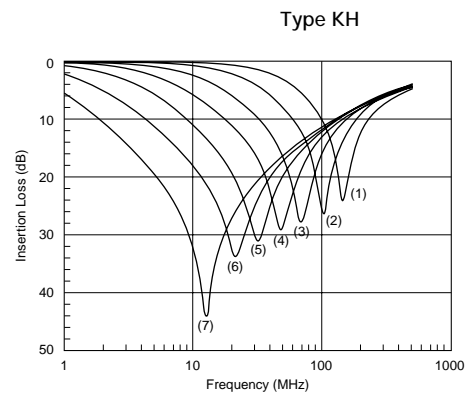
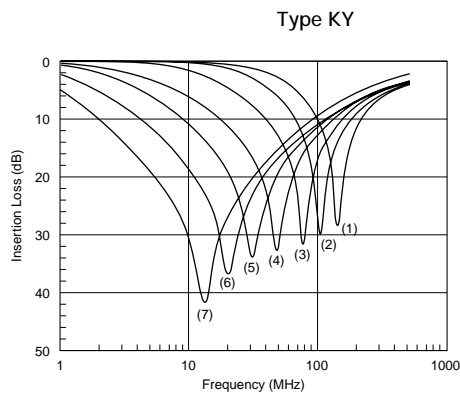

## Safety Certified Ceramic Capacitors Characteristics Data (Typical Example)

### ■ Leakage Current Characteristics

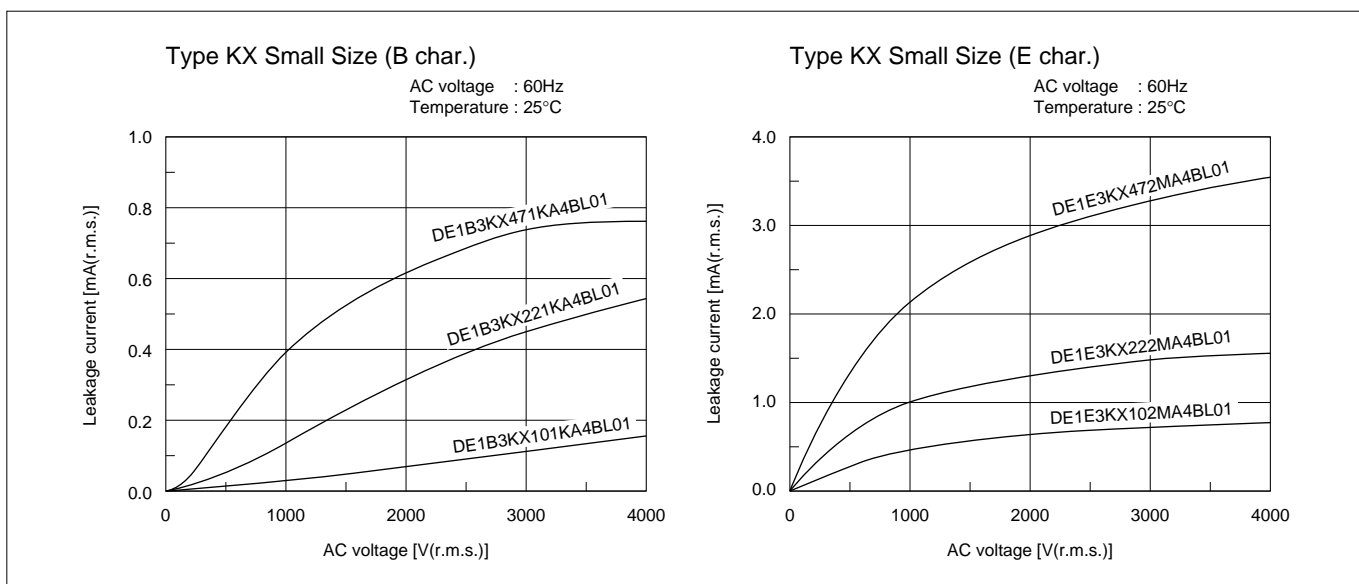
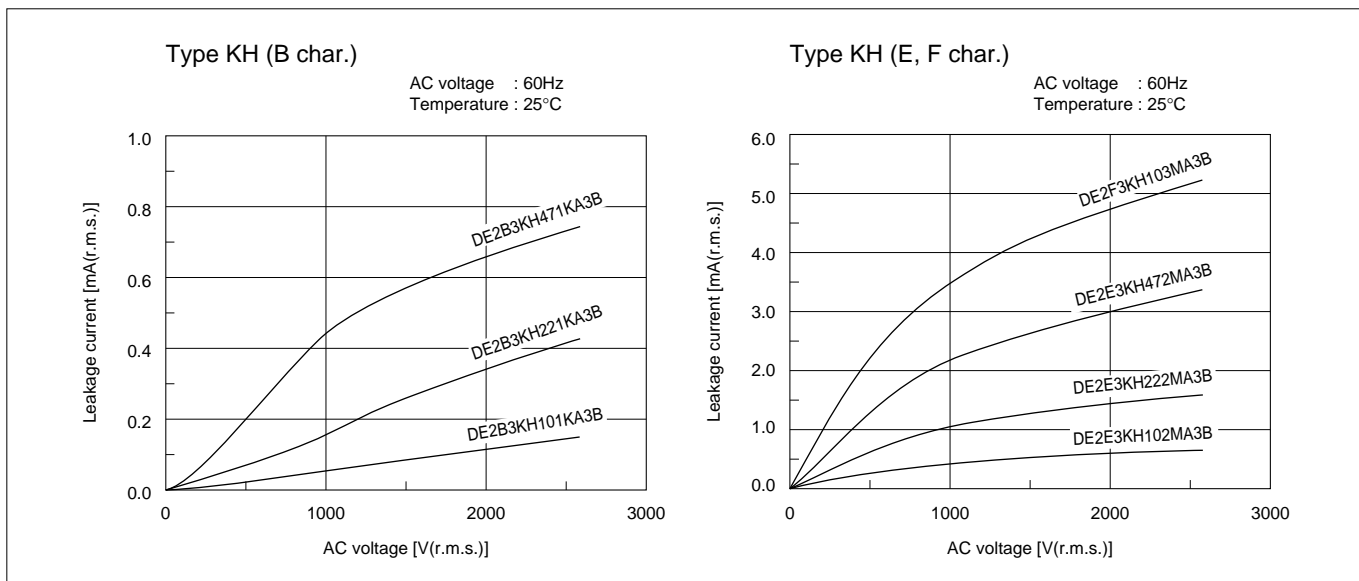
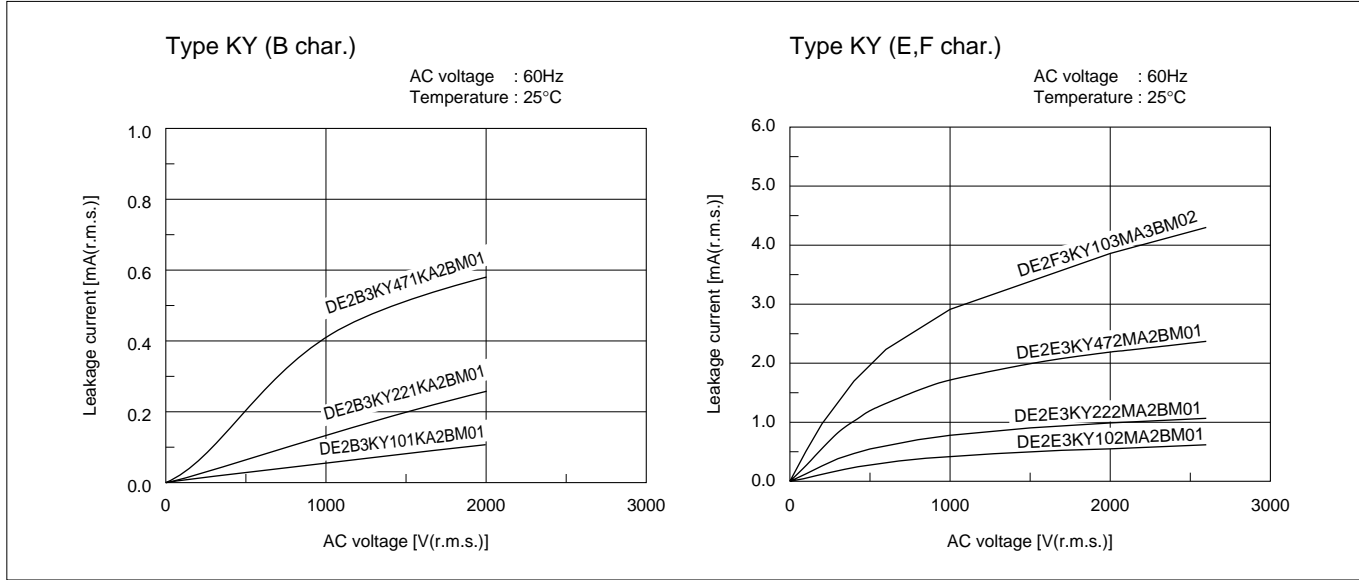

Continued on the following page.

## Safety Certified Ceramic Capacitors Characteristics Data (Typical Example)

↳ Continued from the preceding page.

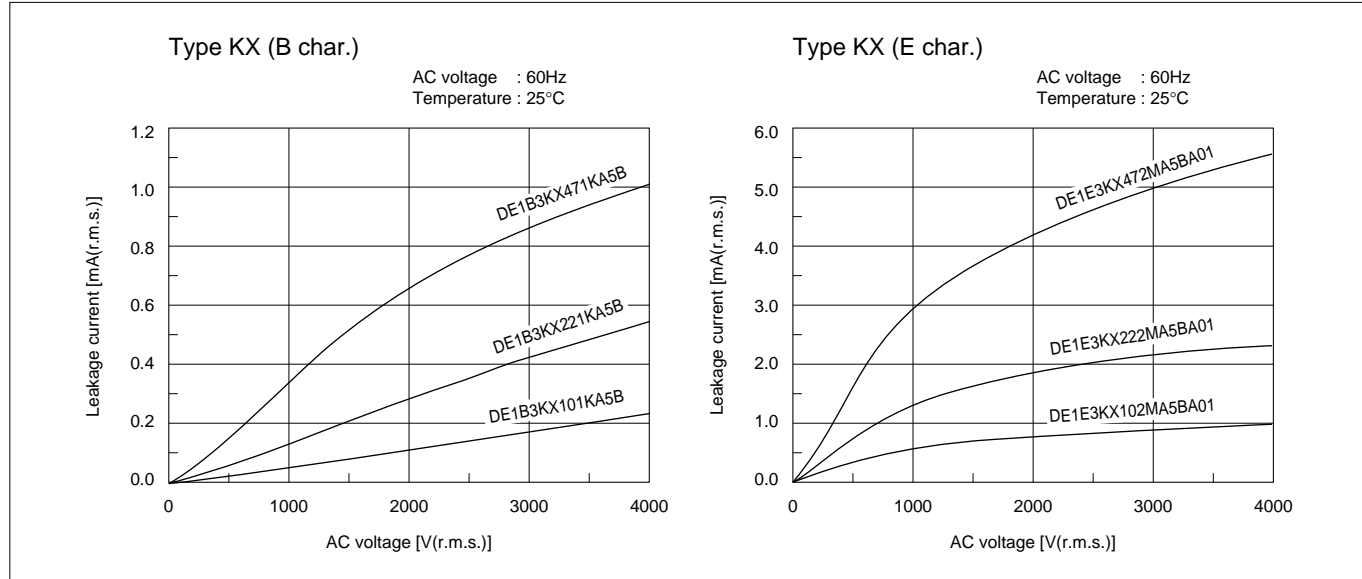

## Safety Certified Ceramic Capacitors Packaging

### ■ Taping Specifications

- 12.7mm pitch / lead spacing 5mm taping  
Vertical crimp type  
(Lead Code: N2)

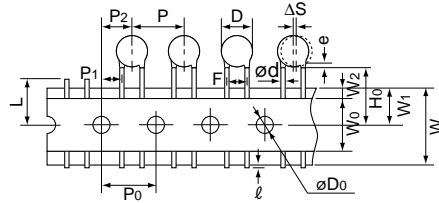

- 15mm pitch / lead spacing 7.5mm taping  
Vertical crimp type  
(Lead Code: N3)

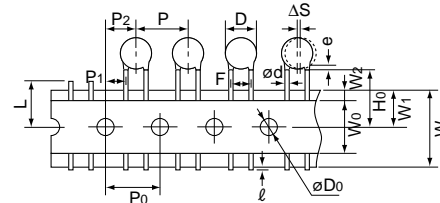

- 15mm pitch / lead spacing 7.5mm taping  
Straight type  
(Lead Code: P3)

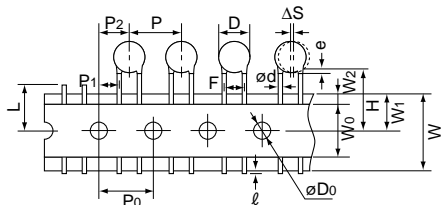

- 30mm pitch / lead spacing 7.5mm taping  
Vertical crimp type  
(Lead Code: N7)

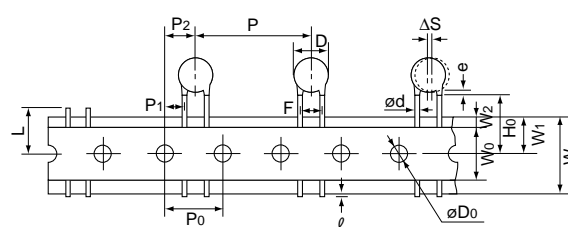

- 25.4mm pitch / lead spacing 10.0mm taping  
Vertical crimp type  
(Lead Code: N4, N5)

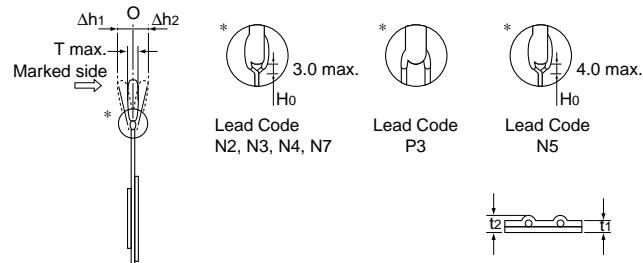
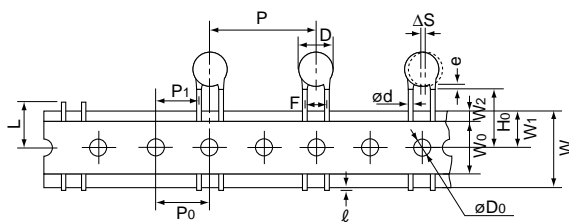

Item	Code	N2	N3	P3	N7	N4	N5
Pitch of component	P	12.7	15.0	15.0	30.0	25.4	
Pitch of sprocket hole	P <sub>0</sub>	12.7±0.3	15.0±0.3	15.0±0.3	15.0±0.3	12.7±0.3	
Lead spacing	F	5.0 <sup>+0.8</sup> <sub>-0.2</sub>	7.5±1.0	7.5±1.0	7.5±1.0	10.0±1.0	
Length from hole center to component center	P <sub>2</sub>	6.35±1.3	7.5±1.5	7.5±1.5	7.5±1.5	—	
Length from hole center to lead	P <sub>1</sub>	3.85±0.7	3.75±1.0	3.75±1.0	3.75±1.0	7.7±1.5	
Body diameter	D	See the individual product specifications.					
Deviation along tape, left or right	ΔS	0±1.0					0±2.0
Carrier tape width	W	18.0±0.5					
Position of sprocket hole	W <sub>1</sub>	9.0±0.5					
Lead distance between reference and bottom planes	H <sub>0</sub>	18.0 <sup>+2.0</sup> <sub>-0</sub>	—		18.0 <sup>+2.0</sup> <sub>-0</sub>		
	H	—		20.0 <sup>+1.5</sup> <sub>-1.0</sub>		—	
Protrusion length	ℓ	+0.5 to -1.0					
Diameter of sprocket hole	∅D <sub>0</sub>	4.0±0.1					
Lead diameter	∅d	0.6±0.05					0.6 <sup>+0.1</sup> <sub>-0.05</sub>
Total tape thickness	t <sub>1</sub>	0.6±0.3					
Total thickness, tape and lead wire	t <sub>2</sub>	1.5 max.					
Body thickness	T	See the individual product specifications.					
Portion to cut in case of defect	L	11.0 <sup>+0</sup> <sub>-1.0</sub>					
Hold down tape width	W <sub>0</sub>	11.5 min.					
Hold down tape position	W <sub>2</sub>	1.5±1.5					
Coating extension on lead	e	Up to the end of crimp		3.0 max.	Up to the end of crimp		
Deviation across tape, front	Δh <sub>1</sub>	1.0 max.		2.0 max.			
Deviation across tape, rear	Δh <sub>2</sub>						



(in mm)

Continued on the following page.

## Safety Certified Ceramic Capacitors Packaging

☒ Continued from the preceding page.

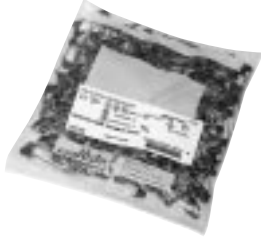
### ■ Packaging Styles

Bulk	Taping
Polyethylene Bag 	Ammo Pack 

### ■ Minimum Quantity (Order in Sets Only)

[Bulk] 1,000 pcs.

[Taping] (pcs.)				
Lead Code	Type KY	Type KH	Type KX	DEJ Series
<b>N2</b>	1,000	–	–	1,500
<b>N3, P3</b>	900	900	–	1,000
<b>N7</b>	–	400	–	–
<b>N4, N5</b>	–	–	500	–

### ■ Minimum Order Quantity

[Bulk] 3,000 pcs.

[Taping] (pcs.)				
Lead Code	Type KY	Type KH	Type KX	DEJ Series
<b>N2</b>	3,000	–	–	3,000
<b>N3, P3</b>	2,700	2,700	–	3,000
<b>N7</b>	–	2,000	–	–
<b>N4, N5</b>	–	–	2,000	–

"Minimum Quantity" means the numbers of units of each delivery or order.  
 The quantity should be an integral multiple of the "minimum quantity".  
 (In case of bulk packaging, minimum quantities differ from packing quantities in a bulk bag.)

## Safety Certified Ceramic Capacitors ⚠Caution

### ■ ⚠Caution (Rating)

#### 1. Operating Voltage

When DC-rated capacitors are to be used in AC or ripple current circuits, be sure to maintain the  $V_{p-p}$  value of the applied voltage or the  $V_{o-p}$  which contains DC bias within the rated voltage range.

When the voltage is applied to the circuit, starting or stopping may generate irregular voltage for a transit period because of resonance or switching. Be sure to use a capacitor with a rated voltage range that includes these irregular voltages.

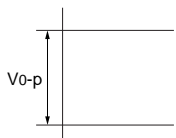
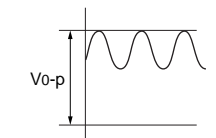
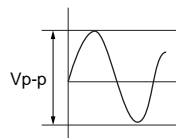
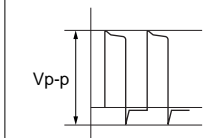
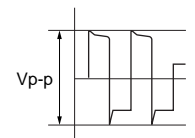
Voltage	DC Voltage	DC+AC Voltage	AC Voltage	Pulse Voltage (1)	Pulse Voltage (2)
Positional Measurement					

#### 2. Operating Temperature and Self-generated Heat (Apply to B/E/F Char.)

Keep the surface temperature of a capacitor below the upper limit of its rated operating temperature range. Be sure to take into account the heat generated by the capacitor itself. When the capacitor is used in a high-frequency current, pulse current or similar current, it may have self-generated heat due to dielectric loss. Applied voltage load should be such that self-generated heat is within 20°C under the condition where the capacitor is subjected to an atmosphere temperature of 25°C. When measuring, use a thermocouple of small thermal capacity-K of  $\phi 0.1\text{mm}$  under conditions where the capacitor is not affected by radiant heat from other components or wind from surroundings. Excessive heat may lead to deterioration of the capacitor's characteristics and reliability. (Never attempt to perform measurement with the cooling fan running. Otherwise, accurate measurement cannot be ensured.)

#### 3. Test Condition for Withstanding Voltage

##### (1) Test Equipment

Test equipment for AC withstanding voltage should be used with the performance of the wave similar to 50/60Hz sine wave.

If the distorted sine wave or overload exceeding the specified voltage value is applied, a defect may be caused.

Continued on the following page. 

## Safety Certified Ceramic Capacitors ⚠Caution

↳ Continued from the preceding page.

### (2) Voltage Applied Method

When the withstanding voltage is applied, capacitor's lead or terminal should be firmly connected to the output of the withstanding voltage test equipment, and then the voltage should be raised from near zero to the test voltage.

If the test voltage without the raise from near zero voltage would be applied directly to capacitor, test voltage should be applied with the zero cross\*. At the end of the test time, the test voltage should be reduced to near zero, and then capacitor's lead or terminal should be taken off the output of the withstanding voltage test equipment.

If the test voltage without the raise from near zero voltage would be applied directly to capacitor, the surge voltage may arise, and therefore, a defect may be caused.

\*ZERO CROSS is the point where voltage sine wave passes 0V. See figure at right.

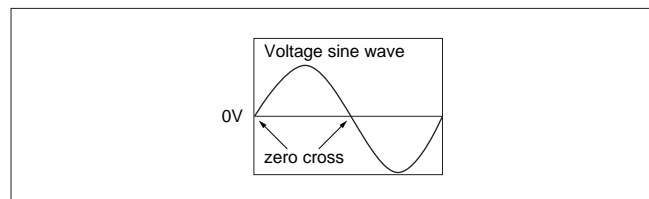

### 4. Fail-Safe

When capacitor is broken, failure may result in a short circuit. Be sure to provide an appropriate fail-safe function like a fuse on your product if failure could result in an electric shock, fire or fuming.

**FAILURE TO FOLLOW THE ABOVE CAUTIONS MAY RESULT, WORST CASE, IN A SHORT CIRCUIT AND CAUSE FUMING OR PARTIAL DISPERSION WHEN THE PRODUCT IS USED.**

## Safety Certified Ceramic Capacitors ⚠Caution

### ■ ⚠Caution (Storage and Operating Condition)

#### Operating and Storage Environment

The insulating coating of capacitors does not form a perfect seal; therefore, do not use or store capacitors in a corrosive atmosphere, especially where chloride gas, sulfide gas, acid, alkali, salt or the like are present. And avoid exposure to moisture. Before cleaning, bonding, or molding this product, verify that these processes do not affect product quality by testing the performance of a cleaned, bonded or molded product in the intended

equipment. Store the capacitors where the temperature and relative humidity do not exceed -10 to 40 degrees centigrade and 15 to 85%.  
Use capacitors within 6 months after delivery.

FAILURE TO FOLLOW THE ABOVE CAUTIONS MAY RESULT, WORST CASE, IN A SHORT CIRCUIT AND CAUSE FUMING OR PARTIAL DISPERSION WHEN THE PRODUCT IS USED.

### ■ ⚠Caution (Soldering and Mounting)

#### 1. Vibration and Impact

Do not expose a capacitor or its leads to excessive shock or vibration during use.

#### 2. Soldering

When soldering this product to a PCB/PWB, do not exceed the solder heat resistance specifications of the capacitor. Subjecting this product to excessive heating could melt the internal junction solder and may result in thermal shocks that can crack the ceramic element.

When soldering capacitor with a soldering iron, it should be performed in the following conditions.

Temperature of iron-tip: 400 degrees C. max.

Soldering iron wattage: 50W max.

Soldering time: 3.5 sec. max.

#### 3. Bonding, Resin Molding and Coating

Before bonding, molding or coating this product, verify that these processes do not affect the quality of capacitor by testing the performance of

the bonded, molded or coated product in the intended equipment.

In case the amount of applications, dryness/hardening conditions of adhesives and molding resins containing organic solvents (ethyl acetate, methyl ethyl ketone, toluene, etc.) are unsuitable, the outer coating resin of a capacitor is damaged by the organic solvents and it may result, worst case, in a short circuit.

The variation in thickness of adhesive, molding resin or coating may cause outer coating resin cracking and/or ceramic element cracking of a capacitor in a temperature cycling.

FAILURE TO FOLLOW THE ABOVE CAUTIONS MAY RESULT, WORST CASE, IN A SHORT CIRCUIT AND CAUSE FUMING OR PARTIAL DISPERSION WHEN THE PRODUCT IS USED.

### ■ ⚠Caution (Handling)

#### Vibration and Impact

Do not expose a capacitor or its leads to excessive shock or vibration during use.

FAILURE TO FOLLOW THE ABOVE CAUTIONS MAY RESULT, WORST CASE, IN A SHORT CIRCUIT AND CAUSE FUMING OR PARTIAL DISPERSION WHEN THE PRODUCT IS USED.

## Safety Certified Ceramic Capacitors Notice

### ■ Notice (Soldering and Mounting)

#### Cleaning (ultrasonic cleaning)

To perform ultrasonic cleaning, observe the following conditions.

Rinse bath capacity: Output of 20 watts per liter or less.

Rinsing time: 5 min. maximum.

Do not vibrate the PCB/PWB directly.

Excessive ultrasonic cleaning may lead to fatigue destruction of the lead wires.

### ■ Notice (Rating)

#### 1. Capacitance Change of Capacitors

##### (1) In case of SL char.

Capacitance might change a little depending on a surrounding temperature or an applied voltage.

Please contact us if you use for the strict constant time circuit.

##### (2) In case of B/E/F char.

Capacitors have an aging characteristic, whereby the capacitor continually decreases its capacitance slightly if the capacitor is left on for a long time. Moreover, capacitance might change greatly depending on the surrounding temperature or an applied voltage. So, it is not likely to be suitable for use in a constant time circuit.

Please contact us if you need detailed information.

#### 2. Performance Check by Equipment

Before using a capacitor, check that there is no problem in the equipment's performance and the specifications.

Generally speaking, CLASS 2 (B/E/F char.) ceramic capacitors have voltage dependence characteristics and temperature dependence characteristics in capacitance. So, the capacitance value may change depending on the operating condition in the equipment. Therefore, be sure to confirm the apparatus performance of receiving influence in the capacitance value change of a capacitor, such as leakage current and noise suppression characteristic.

Moreover, check the surge-proof ability of a capacitor in the equipment, if needed, because the surge voltage may exceed specific value by the inductance of the circuit.

# Safety Certified Ceramic Capacitors/High Voltage Ceramic Capacitors



## DES Series (125 deg. C Guaranteed/Low-dissipation Factor/DC500V-1kV)

### ■ Features

1. Low dissipation factor series which can be used for power supplies with an increased switching frequency.
2. The allowable power in the 100 to 300kHz band is improved to approximately one-and-a-half times that of DEH series while remaining the same size.
3. Operating temperature range is guaranteed up to 125 degrees C.
4. Coated with flame-retardant epoxy resin (equivalent to UL94V-0 standard).
5. Taping available for automatic insertion.

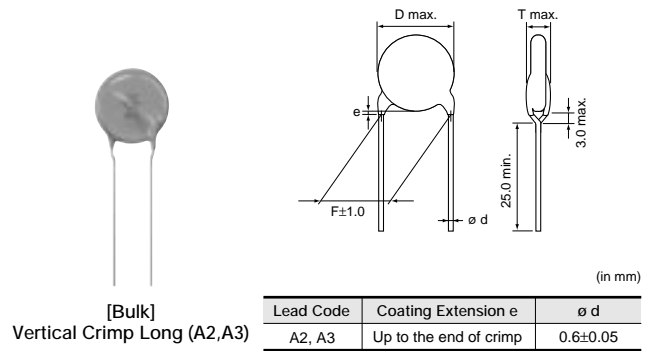

[Bulk]  
Vertical Crimp Long (A2,A3)

### ■ Applications

Ideal for use on high frequency pulse circuits such as snubber circuits for switching power supplies.

Do not use these products in any Automotive Power train or Safety equipment including Battery charger for Electric Vehicles and Plug-in Hybrid. Only Murata products clearly stipulated as "for Automotive use" on its catalog can be used for automobile applications such as Power train and Safety equipment.

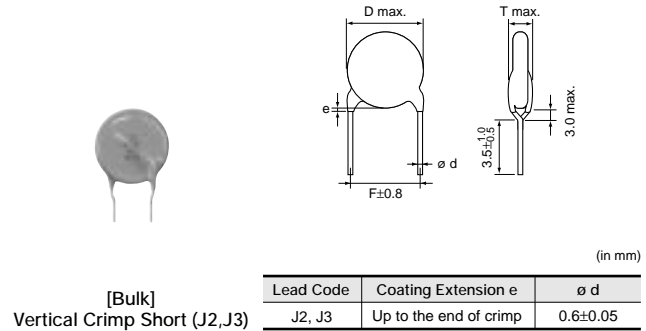

[Bulk]  
Vertical Crimp Short (J2,J3)

6

### ■ Marking

Nominal Body Diameter	Rated Voltage	
	DC500V	DC1kV
ø6mm	S D 101 66	S D 101 1KV 66
ø7-9mm	S D 102K 66	S D 471K 1KV 66
ø10-17mm	S D 222K M 66	S D 152K 1KV M 66
Series Code	Abbreviation (S)	
Temperature Characteristic	Marked with code	
Nominal Capacitance	Marked with 3 figures	
Capacitance Tolerance	Marked with code (omitted for nominal body diameter ø6mm)	
Rated Voltage	Marked with code (omitted for DC500V)	
Manufacturer's Identification	Marked with M (omitted for nominal body diameter ø9mm and under)	
Manufactured Date Code	Abbreviation	

## D Characteristics

Part Number	DC Rated Voltage (V)	Capacitance (pF)	Body Dia. D (mm)	Lead Spacing F (mm)	Body Thickness T (mm)	Lead Package Long Bulk	Lead Package Short Bulk	Lead Package Taping
DESD32H101K□□□	500	100 ±10%	6	5.0	4.0	A2B	J2B	N2A
DESD32H151K□□□	500	150 ±10%	6	5.0	4.0	A2B	J2B	N2A
DESD32H221K□□□	500	220 ±10%	6	5.0	4.0	A2B	J2B	N2A
DESD32H331K□□□	500	330 ±10%	6	5.0	4.0	A2B	J2B	N2A
DESD32H471K□□□	500	470 ±10%	6	5.0	4.0	A2B	J2B	N2A
DESD32H681K□□□	500	680 ±10%	6	5.0	4.0	A2B	J2B	N2A
DESD32H102K□□□	500	1000 ±10%	8	5.0	4.0	A2B	J2B	N2A
DESD32H152K□□□	500	1500 ±10%	9	5.0	4.0	A2B	J2B	N2A
DESD32H222K□□□	500	2200 ±10%	10	5.0	4.0	A2B	J2B	N2A
DESD32H332K□□□	500	3300 ±10%	12	7.5	4.0	A3B	J3B	N3A
DESD32H472K□□□	500	4700 ±10%	14	7.5	4.0	A3B	J3B	N7A
DESD33A101K□□□	1000	100 ±10%	6	5.0	4.5	A2B	J2B	N2A
DESD33A151K□□□	1000	150 ±10%	6	5.0	4.5	A2B	J2B	N2A
DESD33A221K□□□	1000	220 ±10%	6	5.0	4.5	A2B	J2B	N2A
DESD33A331K□□□	1000	330 ±10%	6	5.0	4.5	A2B	J2B	N2A
DESD33A471K□□□	1000	470 ±10%	7	5.0	4.5	A2B	J2B	N2A
DESD33A681K□□□	1000	680 ±10%	8	5.0	4.5	A2B	J2B	N2A
DESD33A102K□□□	1000	1000 ±10%	9	5.0	4.5	A2B	J2B	N2A
DESD33A152K□□□	1000	1500 ±10%	10	5.0	4.5	A2B	J2B	N2A
DESD33A222K□□□	1000	2200 ±10%	12	7.5	4.5	A3B	J3B	N3A
DESD33A332K□□□	1000	3300 ±10%	14	7.5	4.5	A3B	J3B	N7A
DESD33A472K□□□	1000	4700 ±10%	17	7.5	4.5	A3B	J3B	N7A

Three blank columns are filled with the lead and packaging codes. Please refer to the three columns on the right for the appropriate code.

## DES Series Specifications and Test Methods

No.	Item	Specifications	Test Method												
1	Operating Temperature Range	-25 to +125°C													
2	Appearance and Dimensions	No marked defect on appearance form and dimensions are within specified range.	The capacitor should be visually inspected for evidence of defect. Dimensions should be measured with slide calipers.												
3	Marking	To be easily legible	The capacitor should be visually inspected.												
4	Dielectric Strength	Between Lead Wires	No failure  The capacitor should not be damaged when DC voltage of 200% of the rated voltage (DC1kV) or DC voltage of 250% of the rated voltage (DC500V) is applied between the lead wires for 1 to 5 sec. (Charge/Discharge current ≤ 50mA)												
		Body Insulation	No failure  The capacitor is placed in the container with metal balls of diameter 1mm so that each lead wire, short circuited, is kept about 2mm off the metal balls as shown in the figure at right, and AC1250V(r.m.s.) <50/60Hz> is applied for 1 to 5 sec. between capacitor lead wires and metal balls. (Charge/Discharge current ≤ 50mA)												
5	Insulation Resistance (I.R.)	Between Lead Wires	10000MΩ min.  The insulation resistance should be measured with DC500±50V within 60±5 sec. of charging.												
6	Capacitance	Within specified tolerance	The capacitance should be measured at 20°C with 1±0.2kHz and AC5V(r.m.s.) max.												
7	Dissipation Factor (D.F.)	0.3% max.	The dissipation factor should be measured at 20°C with 1±0.2kHz and AC5V(r.m.s.) max.												
8	Temperature Characteristics	Within +20/-30% (Temp. range: -25 to +125°C)	The capacitance measurement should be made at each step specified in Table.												
		Pre-treatment: Capacitor should be stored at 125±3°C for 1 hr., then placed at room condition* for 24±2 hrs. before measurements.													
		<table border="1" style="margin: auto;"> <thead> <tr> <th>Step</th> <th>1</th> <th>2</th> <th>3</th> <th>4</th> <th>5</th> </tr> </thead> <tbody> <tr> <td>Temp. (°C)</td> <td>20±2</td> <td>-25±3</td> <td>20±2</td> <td>125±2</td> <td>20±2</td> </tr> </tbody> </table>	Step	1	2	3	4	5	Temp. (°C)	20±2	-25±3	20±2	125±2	20±2	
Step	1	2	3	4	5										
Temp. (°C)	20±2	-25±3	20±2	125±2	20±2										
9	Strength of Lead	Pull	Lead wire should not be cut off. Capacitor should not be broken.  As shown in the figure at right, fix the body of the capacitor and apply a tensile weight gradually to each lead wire in the radial direction of the capacitor up to 10N and keep it for 10±1 sec.  Each lead wire should be subjected to 5N of weight and bent 90° at the point of egress, in one direction, then returned to its original position and bent 90° in the opposite direction at the rate of one bend in 2 to 3 sec.												
		Bending													
10	Vibration Resistance	Appearance	No marked defect												
		Capacitance	Within specified tolerance												
		D.F.	0.3% max.												
11	Solderability of Leads	Lead wire should be soldered with uniform coating on the axial direction over 3/4 of the circumferential direction.	The lead wire of a capacitor should be dipped into a ethanol solution of 25wt% rosin and then into molten solder for 2±0.5 sec. In both cases the depth of dipping is up to about 1.5 to 2mm from the root of lead wires. Temp. of solder: Lead Free Solder (Sn-3Ag-0.5Cu) 245±5°C H63 Eutectic Solder 235±5°C												
12	Soldering Effect (Non-Preheat)	Appearance	No marked defect												
		Capacitance Change	Within ±10%												
		Dielectric Strength (Between Lead Wires)	Per item 4.												
			Pre-treatment: Capacitor should be stored at 125±3°C for 1 hr., then placed at room condition* for 24±2 hrs. before initial measurements. Post-treatment: Capacitor should be stored for 24±2 hrs. at room condition*.												

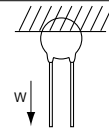
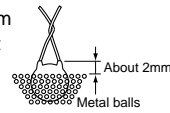

\* "room condition" Temperature: 15 to 35°C, Relative humidity: 45 to 75%, Atmospheric pressure: 86 to 106kPa

Continued on the following page.

## DES Series Specifications and Test Methods

Continued from the preceding page.

No.	Item	Specifications	Test Method															
13	Appearance	No marked defect	First the capacitor should be stored at 120+0/-5°C for 60+0/-5 sec. Then, as in figure, the lead wires should be immersed in solder of 260+0/-5°C up to 1.5 to 2.0mm from the root of terminal for 7.5+0/-1 sec. Pre-treatment: Capacitor should be stored at 125±3°C for 1 hr., then placed at room condition* for 24±2 hrs. before initial measurements. Post-treatment: Capacitor should be stored for 24±2 hrs. at room condition*.															
	Capacitance Change	Within ±10%																
	Dielectric Strength (Between Lead Wires)	Per item 4.																
14	Appearance	No marked defect	The capacitor should be subjected to 5 temperature cycles. <Temperature Cycle> <table border="1" style="margin: 10px auto;"> <thead> <tr> <th>Step</th> <th>Temperature (°C)</th> <th>Time (min)</th> </tr> </thead> <tbody> <tr> <td>1</td> <td>-25±3</td> <td>30</td> </tr> <tr> <td>2</td> <td>Room Temp.</td> <td>3</td> </tr> <tr> <td>3</td> <td>125±3</td> <td>30</td> </tr> <tr> <td>4</td> <td>Room Temp.</td> <td>3</td> </tr> </tbody> </table> Cycle time: 5 cycle Pre-treatment: Capacitor should be stored at 125±3°C for 1 hr., then placed at room condition* for 24±2 hrs. before initial measurements. Post-treatment: Capacitor should be stored for 24±2 hrs. at room condition*.	Step	Temperature (°C)	Time (min)	1	-25±3	30	2	Room Temp.	3	3	125±3	30	4	Room Temp.	3
	Step	Temperature (°C)		Time (min)														
	1	-25±3		30														
	2	Room Temp.		3														
	3	125±3		30														
4	Room Temp.	3																
Capacitance Change	Within ±10%																	
D.F.	0.4% max.																	
I.R.	1000MΩ min.																	
Dielectric Strength (Between Lead Wires)	Per item 4.																	
15	Appearance	No marked defect	Set the capacitor for 500+24/-0 hrs. at 40±2°C in 90 to 95% relative humidity. Pre-treatment: Capacitor should be stored at 125±3°C for 1 hr., then placed at room condition* for 24±2 hrs. before initial measurements. Post-treatment: Capacitor should be stored for 1 to 2 hrs. at room condition*.															
	Capacitance Change	Within ±10%																
	D.F.	0.4% max.																
	I.R.	1000MΩ min.																
16	Appearance	No marked defect	Apply the rated voltage for 500+24/-0 hrs. at 40±2°C in 90 to 95% relative humidity. (Charge/Discharge current≤50mA) Pre-treatment: Capacitor should be stored at 125±3°C for 1 hr., then placed at room condition* for 24±2 hrs. before initial measurements. Post-treatment: Capacitor should be stored for 1 to 2 hrs. at room condition*.															
	Capacitance Change	Within ±10%																
	D.F.	0.6% max.																
	I.R.	1000MΩ min.																
17	Appearance	No marked defect	Apply a DC voltage of 200% of the rated voltage (DC500V) or DC voltage of 150% of the rated voltage (DC1kV) for 1000+48/-0 hrs. at 125±2°C with a relative humidity of 50% max. (Charge/Discharge current≤50mA) Pre-treatment: Capacitor should be stored at 125±3°C for 1 hr., then placed at room condition* for 24±2 hrs. before initial measurements. Post-treatment: Capacitor should be stored at 125±3°C for 1 hr., then placed at room condition* for 24±2 hrs.															
	Capacitance Change	Within ±10%																
	D.F.	0.4% max.																
	I.R.	2000MΩ min.																

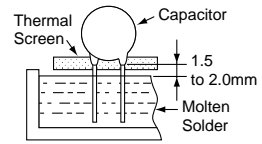

\* "room condition" Temperature: 15 to 35°C, Relative humidity: 45 to 75%, Atmospheric pressure: 86 to 106kPa

# Safety Certified Ceramic Capacitors/High Voltage Ceramic Capacitors



## DEH Series (125 deg. C Guaranteed/Low-dissipation Factor/DC250V-3.15kV)

### ■ Features

1. Reduced heat dissipation permitted due to small dielectric loss of the ceramic material.
2. Operating temperature range is guaranteed up to 125 degrees C.
3. Coated with flame-retardant epoxy resin (equivalent to UL94V-0 standard).
4. Taping available for automatic insertion.

### ■ Applications

Ideal for use on high frequency pulse circuits such as a horizontal resonance circuit for CTV and snubber circuits for switching power supplies.

Do not use these products in any Automotive Power train or Safety equipment including Battery charger for Electric Vehicles and Plug-in Hybrid. Only Murata products clearly stipulated as "for Automotive use" on its catalog can be used for automobile applications such as Power train and Safety equipment.

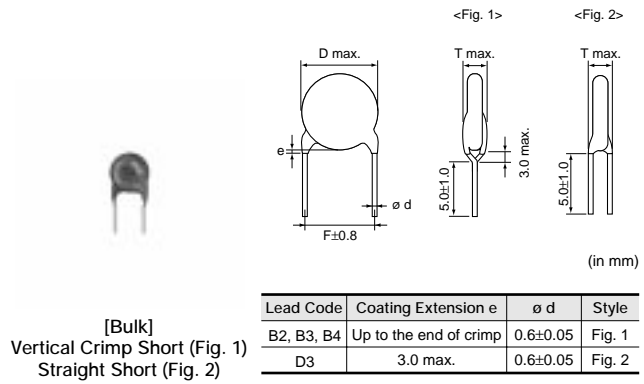
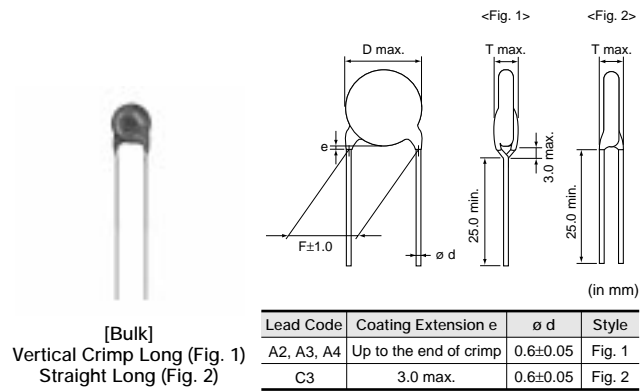

### ■ Marking

Nominal Body Diameter	Rated Voltage	DC250V	DC500V	DC1-3.15kV
	Temp. Char.	R	C	R
ø6mm		HR 102 66	HR 471 66	—
ø7-9mm		HR R 332K 250V 66	HR C 152K 66	HR R 102K 1KV 66
ø10-21mm		HR R 103K 250V M66	HR C 472K M66	HR R 272K 3KV M66
High Temperature Guaranteed Code		HR		
Temperature Characteristics		Marked with code (omitted for nominal body diameter ø6mm)		
Nominal Capacitance		Marked with 3 figures		
Capacitance Tolerance		Marked with code (omitted for nominal body diameter ø6mm)		
Rated Voltage	DC250V	Marked with code (Marked with horizontal line over nominal capacitance for nominal body diameter ø6mm)		
	DC500V	Omitted		
	DC1-3.15kV	Marked with code (In case of DC3.15kV, marked with 3KV)		
Manufacturer's Identification		Marked with M (omitted for nominal body diameter ø9mm and under)		
Manufactured Date Code		Abbreviation		

### DC250V, R Characteristics

Part Number	DC Rated Voltage (V)	Capacitance (pF)	Body Dia. D (mm)	Lead Spacing F (mm)	Body Thickness T (mm)	Lead Package Long Bulk	Lead Package Short Bulk	Lead Package Taping
DEHR32E221K□□□□	250	220 ±10%	6	5.0	4.0	A2B	B2B	N2A
DEHR32E331K□□□□	250	330 ±10%	6	5.0	4.0	A2B	B2B	N2A
DEHR32E471K□□□□	250	470 ±10%	6	5.0	4.0	A2B	B2B	N2A
DEHR32E681K□□□□	250	680 ±10%	6	5.0	4.0	A2B	B2B	N2A
DEHR32E102K□□□□	250	1000 ±10%	6	5.0	4.0	A2B	B2B	N2A
DEHR32E152K□□□□	250	1500 ±10%	7	5.0	4.0	A2B	B2B	N2A
DEHR32E222K□□□□	250	2200 ±10%	8	5.0	4.0	A2B	B2B	N2A
DEHR32E332K□□□□	250	3300 ±10%	9	5.0	4.0	A2B	B2B	N2A
DEHR32E472K□□□□	250	4700 ±10%	10	5.0	4.0	A2B	B2B	N2A
DEHR32E682K□□□□	250	6800 ±10%	12	5.0	4.0	A2B	B2B	N2A
DEHR32E103K□□□□	250	10000 ±10%	12	5.0	4.0	A2B	B2B	N2A

Three blank columns are filled with the lead and packaging codes. Please refer to the three columns on the right for the appropriate code.

### DC500V, C Characteristics

Part Number	DC Rated Voltage (V)	Capacitance (pF)	Body Dia. D (mm)	Lead Spacing F (mm)	Body Thickness T (mm)	Lead Package Long Bulk	Lead Package Short Bulk	Lead Package Taping
DEHC32H331K□□□□	500	330 ±10%	6	5.0	4.0	A2B	B2B	N2A
DEHC32H471K□□□□	500	470 ±10%	6	5.0	4.0	A2B	B2B	N2A
DEHC32H681K□□□□	500	680 ±10%	7	5.0	4.0	A2B	B2B	N2A
DEHC32H102K□□□□	500	1000 ±10%	8	5.0	4.0	A2B	B2B	N2A
DEHC32H152K□□□□	500	1500 ±10%	9	5.0	4.0	A2B	B2B	N2A
DEHC32H222K□□□□	500	2200 ±10%	10	5.0	4.0	A2B	B2B	N2A
DEHC32H332K□□□□	500	3300 ±10%	12	5.0	4.0	A2B	B2B	N2A
DEHC32H472K□□□□	500	4700 ±10%	14	10.0	4.0	A4B	B4B	-

Three blank columns are filled with the lead and packaging codes. Please refer to the three columns on the right for the appropriate code.

### DC1-3.15kV, R Characteristics

Part Number	DC Rated Voltage (V)	Capacitance (pF)	Body Dia. D (mm)	Lead Spacing F (mm)	Body Thickness T (mm)	Lead Package Long Bulk	Lead Package Short Bulk	Lead Package Taping
DEHR33A221K□□□□	1000	220 ±10%	7	5.0	4.5	A2B	B2B	N2A
DEHR33A331K□□□□	1000	330 ±10%	7	5.0	4.5	A2B	B2B	N2A
DEHR33A471K□□□□	1000	470 ±10%	7	5.0	4.5	A2B	B2B	N2A
DEHR33A681K□□□□	1000	680 ±10%	8	5.0	4.5	A2B	B2B	N2A
DEHR33A102K□□□□	1000	1000 ±10%	9	5.0	4.5	A2B	B2B	N2A
DEHR33A152K□□□□	1000	1500 ±10%	11	5.0	4.5	A2B	B2B	N2A
DEHR33A222K□□□□	1000	2200 ±10%	13	7.5	4.5	A3B	B3B	N3A
DEHR33A332K□□□□	1000	3300 ±10%	15	7.5	4.5	A3B	B3B	N7A
DEHR33A472K□□□□	1000	4700 ±10%	17	7.5	4.5	A3B	B3B	N7A
DEHR33D221K□□□□	2000	220 ±10%	7	7.5	5.0	C3B	D3B	P3A
DEHR33D271K□□□□	2000	270 ±10%	7	7.5	5.0	C3B	D3B	P3A
DEHR33D331K□□□□	2000	330 ±10%	8	7.5	5.0	A3B	B3B	N3A
DEHR33D391K□□□□	2000	390 ±10%	8	7.5	5.0	A3B	B3B	N3A
DEHR33D471K□□□□	2000	470 ±10%	9	7.5	5.0	A3B	B3B	N3A
DEHR33D561K□□□□	2000	560 ±10%	9	7.5	5.0	A3B	B3B	N3A
DEHR33D681K□□□□	2000	680 ±10%	10	7.5	5.0	A3B	B3B	N3A
DEHR33D821K□□□□	2000	820 ±10%	11	7.5	5.0	A3B	B3B	N3A
DEHR33D102K□□□□	2000	1000 ±10%	12	7.5	5.0	A3B	B3B	N3A
DEHR33D122K□□□□	2000	1200 ±10%	12	7.5	5.0	A3B	B3B	N3A
DEHR33D152K□□□□	2000	1500 ±10%	12	7.5	5.0	A3B	B3B	N3A
DEHR33D182K□□□□	2000	1800 ±10%	14	7.5	5.0	A3B	B3B	N7A

Continued on the following page. 

⚠Note • This PDF catalog is downloaded from the website of Murata Manufacturing co., Ltd. Therefore, it's specifications are subject to change or our products in it may be discontinued without advance notice. Please check with our sales representatives or product engineers before ordering.  
 • This PDF catalog has only typical specifications because there is no space for detailed specifications. Therefore, please approve our product specifications or transact the approval sheet for product specifications before ordering.

Continued from the preceding page.

Part Number	DC Rated Voltage (V)	Capacitance (pF)	Body Dia. D (mm)	Lead Spacing F (mm)	Body Thickness T (mm)	Lead Package Long Bulk	Lead Package Short Bulk	Lead Package Taping
DEHR33D222K□□□	2000	2200 ±10%	15	7.5	5.0	A3B	B3B	N7A
DEHR33D272K□□□	2000	2700 ±10%	17	7.5	5.0	A3B	B3B	N7A
DEHR33D332K□□□	2000	3300 ±10%	19	10.0	5.0	A4B	B4B	-
DEHR33D392K□□□	2000	3900 ±10%	20	10.0	5.0	A4B	B4B	-
DEHR33D472K□□□	2000	4700 ±10%	21	10.0	5.0	A4B	B4B	-
DEHR33F151K□□□	3150	150 ±10%	7	7.5	6.0	C3B	D3B	P3A
DEHR33F181K□□□	3150	180 ±10%	7	7.5	6.0	C3B	D3B	P3A
DEHR33F221K□□□	3150	220 ±10%	7	7.5	6.0	C3B	D3B	P3A
DEHR33F271K□□□	3150	270 ±10%	7	7.5	6.0	C3B	D3B	P3A
DEHR33F331K□□□	3150	330 ±10%	8	7.5	6.0	A3B	B3B	N3A
DEHR33F391K□□□	3150	390 ±10%	9	7.5	6.0	A3B	B3B	N3A
DEHR33F471K□□□	3150	470 ±10%	10	7.5	6.0	A3B	B3B	N3A
DEHR33F561K□□□	3150	560 ±10%	10	7.5	6.0	A3B	B3B	N3A
DEHR33F681K□□□	3150	680 ±10%	11	7.5	6.0	A3B	B3B	N3A
DEHR33F821K□□□	3150	820 ±10%	12	7.5	6.0	A3B	B3B	N3A
DEHR33F102K□□□	3150	1000 ±10%	13	7.5	6.0	A3B	B3B	N3A
DEHR33F122K□□□	3150	1200 ±10%	14	7.5	6.0	A3B	B3B	N7A
DEHR33F152K□□□	3150	1500 ±10%	15	7.5	6.0	A3B	B3B	N7A
DEHR33F182K□□□	3150	1800 ±10%	16	7.5	6.0	A3B	B3B	N7A
DEHR33F222K□□□	3150	2200 ±10%	17	7.5	6.0	A3B	B3B	N7A
DEHR33F272K□□□	3150	2700 ±10%	19	10.0	6.0	A4B	B4B	-

Three blank columns are filled with the lead and packaging codes. Please refer to the three columns on the right for the appropriate code.

## DEH Series Specifications and Test Methods

No.	Item		Specifications	Test Method											
1	Operating Temperature Range		-25 to +125°C												
2	Appearance and Dimensions		No marked defect on appearance form and dimensions are within specified range.	The capacitor should be visually inspected for evidence of defect. Dimensions should be measured with slide calipers.											
3	Marking		To be easily legible	The capacitor should be visually inspected.											
4	Dielectric Strength	Between Lead Wires	No failure	The capacitor should not be damaged when DC voltage of 200% of the rated voltage (DC1 to 3.15kV) or DC voltage of 250% of the rated voltage (DC250V, DC500V) is applied between the lead wires for 1 to 5 sec. (Charge/Discharge current ≤ 50mA)											
		Body Insulation	No failure	The capacitor is placed in the container with metal balls of diameter 1mm so that each lead wire, short circuited, is kept about 2mm off the metal balls as shown in the figure at right, and AC1250V(r.m.s.) <50/60Hz> is applied for 1 to 5 sec. between capacitor lead wires and metal balls. (Charge/Discharge current ≤ 50mA)											
5	Insulation Resistance (I.R.)	Between Lead Wires	Char. R [DC1 to 3.15kV], Char. C : 10000MΩ min. Char. R [DC250V]: 1000MΩ min.	The insulation resistance should be measured with DC500±50V (Char. R [DC 250V]: DC100±15V) within 60±5 sec. of charging.											
6	Capacitance		Within specified tolerance	The capacitance should be measured at 20°C with 1±0.2kHz and AC5V(r.m.s.) max.											
7	Dissipation Factor (D.F.)		Char. R [DC250V]: 0.4% max. Char. R [DC1 to 3.15kV]: 0.2% max. Char. C: 0.3% max.	The dissipation factor should be measured at 20°C with 1±0.2kHz and AC5V(r.m.s.) max.											
8	Temperature Characteristics		<table border="1"> <thead> <tr> <th rowspan="2">T. C.</th> <th colspan="2">Temp. Char.</th> </tr> <tr> <th>-25 to +85°C</th> <th>+85 to +125°C</th> </tr> </thead> <tbody> <tr> <td>R</td> <td>Within ±15%</td> <td rowspan="2">Within +15/-30%</td> </tr> <tr> <td>C</td> <td>Within ±20%</td> </tr> </tbody> </table>	T. C.	Temp. Char.		-25 to +85°C	+85 to +125°C	R	Within ±15%	Within +15/-30%	C	Within ±20%	The capacitance measurement should be made at each step specified in Table.	
			T. C.		Temp. Char.										
-25 to +85°C	+85 to +125°C														
R	Within ±15%	Within +15/-30%													
C	Within ±20%														
Pre-treatment: Capacitor should be stored at 125±3°C for 1 hr., then placed at room condition** for 24±2 hrs. before measurements. <table border="1"> <thead> <tr> <th>Step</th> <th>1</th> <th>2</th> <th>3</th> <th>4</th> <th>5</th> </tr> </thead> <tbody> <tr> <td>Temp. (°C)</td> <td>20±2</td> <td>-25±3</td> <td>20±2</td> <td>125±2</td> <td>20±2</td> </tr> </tbody> </table>			Step	1	2	3	4	5	Temp. (°C)	20±2	-25±3	20±2	125±2	20±2	
Step	1	2	3	4	5										
Temp. (°C)	20±2	-25±3	20±2	125±2	20±2										
9	Strength of Lead	Pull	Lead wire should not be cut off. Capacitor should not be broken.	As shown in the figure at right, fix the body of the capacitor and apply a tensile weight gradually to each lead wire in the radial direction of the capacitor up to 10N (5N for lead diameter 0.5mm), and keep it for 10±1 sec.											
		Bending		Each lead wire should be subjected to 5N (2.5N for lead diameter 0.5mm) of weight and bent 90° at the point of egress, in one direction, then returned to its original position and bent 90° in the opposite direction at the rate of one bend in 2 to 3 sec.											
10	Vibration Resistance	Appearance	No marked defect	The capacitor should be firmly soldered to the supporting lead wire and vibrated at a frequency range of 10 to 55Hz, 1.5mm in total amplitude, with about a 1 minute rate of vibration change from 10Hz to 55Hz and back to 10Hz. Apply for a total of 6 hrs., 2 hrs. each in 3 mutually perpendicular directions.											
		Capacitance	Within specified tolerance												
		D.F.	Char. R [DC250V]: 0.4% max. Char. R [DC1 to 3.15kV]: 0.2% max. Char. C: 0.3% max.												
11	Solderability of Leads		Lead wire should be soldered with uniform coating on the axial direction over 3/4 of the circumferential direction.	The lead wire of a capacitor should be dipped into a ethanol solution of 25wt% rosin and then into molten solder for 2±0.5 sec. In both cases the depth of dipping is up to about 1.5 to 2mm from the root of lead wires. Temp. of solder: Lead Free Solder (Sn-3Ag-0.5Cu) 245±5°C H63 Eutectic Solder 235±5°C											

\*\* "room condition" Temperature: 15 to 35°C, Relative humidity: 45 to 75%, Atmospheric pressure: 86 to 106kPa

Continued on the following page. 

7

## DEH Series Specifications and Test Methods

Continued from the preceding page.

No.	Item	Specifications	Test Method
12	Appearance	No marked defect	The lead wire should be immersed into the melted solder of 350±10°C up to about 1.5 to 2mm from the main body for 3.5±0.5 sec. Pre-treatment: Capacitor should be stored at 125±3°C for 1 hr., then placed at room condition*1 for 24±2 hrs. before initial measurements. Post-treatment: Capacitor should be stored for 24±2 hrs. at room condition*1. Measurement order: Dielectric strength -> Pre-treatment -> Capacitance -> Soldering effect test -> Post-treatment -> Capacitance · Dielectric strength (Char. R [DC250V])
	Capacitance Change	Within ±10%	
	Dielectric Strength (Between Lead Wires)	Per item 4.	
13	Appearance	No marked defect	First the capacitor should be stored at 120+0/-5°C for 60+0/-5 sec. Then, as in figure, the lead wires should be immersed in solder of 260+0/-5°C up to 1.5 to 2.0mm from the root of terminal for 7.5+0/-1 sec. Pre-treatment: Capacitor should be stored at 125±3°C for 1 hr., then placed at room condition*1 for 24±2 hrs. before initial measurements. Post-treatment: Capacitor should be stored for 24±2 hrs. at room condition*1. Measurement order: Dielectric strength -> Pre-treatment -> Capacitance -> Soldering effect test -> Post-treatment -> Capacitance · Dielectric strength (Char. R [DC250V])
	Capacitance Change	Within ±10%	
	Dielectric Strength (Between Lead Wires)	Per item 4.	

Step	Temperature (°C)	Time (min)
1	-25±3	30
2	Room Temp.	3
3	125±3	30
4	Room Temp.	3

Cycle time: 5 cycle

\*1 "room condition" Temperature: 15 to 35°C, Relative humidity: 45 to 75%, Atmospheric pressure: 86 to 106kPa

Continued on the following page.

## DEH Series Specifications and Test Methods

Continued from the preceding page.

No.	Item	Specifications	Test Method
16	Humidity Loading	Appearance	Apply the rated voltage for 500+24/-0 hrs. at 40±2°C in 90 to 95% relative humidity. (Charge/Discharge current≤50mA) Pre-treatment: Capacitor should be stored at 125±3°C for 1 hr., then placed at room condition*1 for 24±2 hrs. before initial measurements. Post-treatment: Capacitor should be stored for 1 to 2 hrs. at room condition*1. (Char. R [DC1 to 3.15kV], Char. C) Post-treatment: Capacitor should be stored at 125±3°C for 1 hr., then placed at room condition*1 for 24±2 hrs. (Char. R [DC250V]) Measurement order: I.R. -> Pre-treatment -> Capacitance • D.F. -> Humidity loading test -> I.R.*2 -> Post-treatment -> Capacitance • D.F. (Char. R [DC250V])
	Capacitance Change	Within ±10%	
	D.F.	0.6% max.	
	I.R.	1000MΩ min.	
17	Life	Appearance	Apply a DC voltage of 200% of the rated voltage (DC250V, DC500V) or DC voltage of 150% of the rated voltage (DC1 to 3.15kV) for 1000 +48/-0 hrs. at 125±2°C with a relative humidity of 50% max. (Charge/Discharge current≤50mA) Pre-treatment: Capacitor should be stored at 125±3°C for 1 hr., then placed at room condition*1 for 24±2 hrs. before initial measurements. Post-treatment: Capacitor should be stored at 125±3°C for 1 hr., then placed at room condition*1 for 24±2 hrs. Measurement order: I.R. -> Pre-treatment -> Capacitance • D.F. -> Life test -> I.R.*3 -> Post-treatment -> Capacitance • D.F. (Char. R [DC250V])
	Capacitance Change	Within ±10%	
	D.F.	0.4% max.	
	I.R.	Char. R [DC1 to 3.15kV], Char. C : 2000MΩ min. Char. R [DC250V]: 1000MΩ min.	

\*1 "room condition" Temperature: 15 to 35°C, Relative humidity: 45 to 75%, Atmospheric pressure: 86 to 106kPa

\*2 The measurement of I.R. will be held in 1 to 2 hrs. after Humidity loading test.

\*3 The measurement of I.R. will be held in 12 to 24 hrs. after Life test.

# Safety Certified Ceramic Capacitors/High Voltage Ceramic Capacitors



## DEA Series (125 deg. C Guaranteed/Class 1/DC1k-3.15kV)

### ■ Features

1. Temperature compensating type ceramics realize low heat dissipation than DEH/DES series.
2. Operating temperature range is guaranteed up to 125 degrees C.
3. Coated with flame-retardant epoxy resin (equivalent to UL94V-0 standard).
4. Taping available for automatic insertion.

### ■ Applications

1. Ideal for use as the ballast in back lighting inverters for liquid crystal display.
2. Ideal for use on high frequency pulse circuits such as a horizontal resonance circuit for CTV and snubber circuits for switching power supplies.

Do not use these products in any Automotive Power train or Safety equipment including Battery charger for Electric Vehicles and Plug-in Hybrid. Only Murata products clearly stipulated as "for Automotive use" on its catalog can be used for automobile applications such as Power train and Safety equipment.

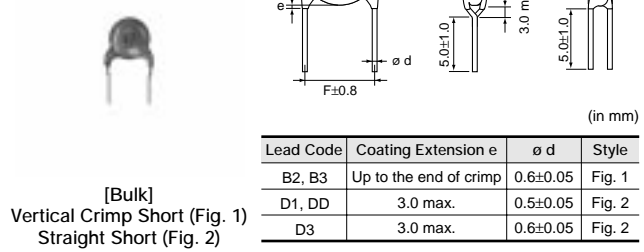
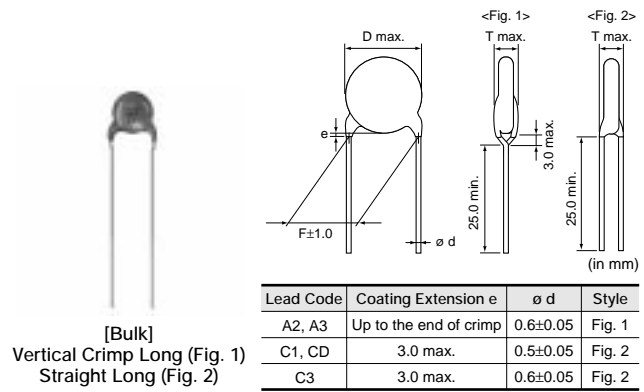

### ■ Marking

Nominal Body Diameter	Temp. Char.	SL
ø4.5-5mm		68 1KV
ø6mm		39 3KV 66
ø7-9mm		181J 2KV 66
ø10-16mm		391J 3KV M 66
Nominal Capacitance		Under 100pF: Actual value, 100pF and over: Marked with 3 figures
Capacitance Tolerance		Marked with code (omitted for nominal body diameter ø6mm and under)
Rated Voltage		Marked with code (In case of DC3.15kV, marked with 3KV)
Manufacturer's Identification		Marked with M (omitted for nominal body diameter ø9mm and under)
Manufactured Date Code		Abbreviation (omitted for nominal body diameter ø5mm and under)

## SL Characteristics

Part Number	DC Rated Voltage (V)	Capacitance (pF)	Body Dia. D (mm)	Lead Spacing F (mm)	Body Thickness T (mm)	Lead Package Long Bulk	Lead Package Short Bulk	Lead Package Taping
DEA1X3A100J□□□	1000	10 ±5%	4.5	5.0	4.0	C1B	D1B	P2A
DEA1X3A120J□□□	1000	12 ±5%	4.5	5.0	4.0	C1B	D1B	P2A
DEA1X3A150J□□□	1000	15 ±5%	4.5	5.0	4.0	C1B	D1B	P2A
DEA1X3A180J□□□	1000	18 ±5%	4.5	5.0	4.0	C1B	D1B	P2A
DEA1X3A220J□□□	1000	22 ±5%	4.5	5.0	4.0	C1B	D1B	P2A
DEA1X3A270J□□□	1000	27 ±5%	4.5	5.0	4.0	C1B	D1B	P2A
DEA1X3A330J□□□	1000	33 ±5%	4.5	5.0	4.0	C1B	D1B	P2A
DEA1X3A390J□□□	1000	39 ±5%	4.5	5.0	4.0	C1B	D1B	P2A
DEA1X3A470J□□□	1000	47 ±5%	4.5	5.0	4.0	C1B	D1B	P2A
DEA1X3A560J□□□	1000	56 ±5%	5	5.0	4.0	C1B	D1B	P2A
DEA1X3A680J□□□	1000	68 ±5%	5	5.0	4.0	C1B	D1B	P2A
DEA1X3A820J□□□	1000	82 ±5%	6	5.0	4.0	A2B	B2B	N2A
DEA1X3A101J□□□	1000	100 ±5%	6	5.0	4.0	A2B	B2B	N2A
DEA1X3A121J□□□	1000	120 ±5%	6	5.0	4.0	A2B	B2B	N2A
DEA1X3A151J□□□	1000	150 ±5%	7	5.0	4.0	A2B	B2B	N2A
DEA1X3A181J□□□	1000	180 ±5%	7	5.0	4.0	A2B	B2B	N2A
DEA1X3A221J□□□	1000	220 ±5%	8	5.0	4.0	A2B	B2B	N2A
DEA1X3A271J□□□	1000	270 ±5%	9	5.0	4.0	A2B	B2B	N2A
DEA1X3A331J□□□	1000	330 ±5%	10	5.0	4.0	A2B	B2B	N2A
DEA1X3A391J□□□	1000	390 ±5%	10	5.0	4.0	A2B	B2B	N2A
DEA1X3A471J□□□	1000	470 ±5%	11	5.0	4.0	A2B	B2B	N2A
DEA1X3A561J□□□	1000	560 ±5%	12	7.5	4.0	A3B	B3B	N3A
DEA1X3D100J□□□	2000	10 ±5%	4.5	5.0	5.0	C1B	D1B	P2A
DEA1X3D120J□□□	2000	12 ±5%	4.5	5.0	5.0	C1B	D1B	P2A
DEA1X3D150J□□□	2000	15 ±5%	4.5	5.0	5.0	C1B	D1B	P2A
DEA1X3D180J□□□	2000	18 ±5%	4.5	5.0	5.0	C1B	D1B	P2A
DEA1X3D220J□□□	2000	22 ±5%	4.5	5.0	5.0	C1B	D1B	P2A
DEA1X3D270J□□□	2000	27 ±5%	4.5	5.0	5.0	C1B	D1B	P2A
DEA1X3D330J□□□	2000	33 ±5%	4.5	5.0	5.0	C1B	D1B	P2A
DEA1X3D390J□□□	2000	39 ±5%	5	5.0	5.0	C1B	D1B	P2A
DEA1X3D470J□□□	2000	47 ±5%	6	5.0	5.0	A2B	B2B	N2A
DEA1X3D560J□□□	2000	56 ±5%	6	5.0	5.0	A2B	B2B	N2A
DEA1X3D680J□□□	2000	68 ±5%	6	5.0	5.0	A2B	B2B	N2A
DEA1X3D820J□□□	2000	82 ±5%	7	5.0	5.0	A2B	B2B	N2A
DEA1X3D101J□□□	2000	100 ±5%	7	5.0	5.0	A2B	B2B	N2A
DEA1X3D121J□□□	2000	120 ±5%	8	5.0	5.0	A2B	B2B	N2A
DEA1X3D151J□□□	2000	150 ±5%	8	5.0	5.0	A2B	B2B	N2A
DEA1X3D181J□□□	2000	180 ±5%	9	5.0	5.0	A2B	B2B	N2A
DEA1X3D221J□□□	2000	220 ±5%	10	5.0	5.0	A2B	B2B	N2A
DEA1X3D271J□□□	2000	270 ±5%	11	5.0	5.0	A2B	B2B	N2A
DEA1X3D331J□□□	2000	330 ±5%	12	7.5	5.0	A3B	B3B	N3A
DEA1X3D391J□□□	2000	390 ±5%	13	7.5	5.0	A3B	B3B	N3A
DEA1X3D471J□□□	2000	470 ±5%	14	7.5	5.0	A3B	B3B	N7A
DEA1X3D561J□□□	2000	560 ±5%	15	7.5	5.0	A3B	B3B	N7A
DEA1X3F100J□□□	3150	10 ±5%	5	7.5	6.0	CDB	DDB	P3A
DEA1X3F120J□□□	3150	12 ±5%	5	7.5	6.0	CDB	DDB	P3A
DEA1X3F150J□□□	3150	15 ±5%	5	7.5	6.0	CDB	DDB	P3A
DEA1X3F180J□□□	3150	18 ±5%	5	7.5	6.0	CDB	DDB	P3A
DEA1X3F220J□□□	3150	22 ±5%	5	7.5	6.0	CDB	DDB	P3A
DEA1X3F270J□□□	3150	27 ±5%	6	7.5	6.0	C3B	D3B	P3A
DEA1X3F330J□□□	3150	33 ±5%	6	7.5	6.0	C3B	D3B	P3A
DEA1X3F390J□□□	3150	39 ±5%	6	7.5	6.0	C3B	D3B	P3A
DEA1X3F470J□□□	3150	47 ±5%	7	7.5	6.0	C3B	D3B	P3A
DEA1X3F560J□□□	3150	56 ±5%	7	7.5	6.0	C3B	D3B	P3A

Continued on the following page. 

⚠Note • This PDF catalog is downloaded from the website of Murata Manufacturing co., Ltd. Therefore, it's specifications are subject to change or our products in it may be discontinued without advance notice. Please check with our sales representatives or product engineers before ordering.  
 • This PDF catalog has only typical specifications because there is no space for detailed specifications. Therefore, please approve our product specifications or transact the approval sheet for product specifications before ordering.

Continued from the preceding page.

Part Number	DC Rated Voltage (V)	Capacitance (pF)	Body Dia. D (mm)	Lead Spacing F (mm)	Body Thickness T (mm)	Lead Package Long Bulk	Lead Package Short Bulk	Lead Package Taping
DEA1X3F680J□□□	3150	68 ±5%	8	7.5	6.0	A3B	B3B	N3A
DEA1X3F820J□□□	3150	82 ±5%	8	7.5	6.0	A3B	B3B	N3A
DEA1X3F101J□□□	3150	100 ±5%	9	7.5	6.0	A3B	B3B	N3A
DEA1X3F121J□□□	3150	120 ±5%	10	7.5	6.0	A3B	B3B	N3A
DEA1X3F151J□□□	3150	150 ±5%	11	7.5	6.0	A3B	B3B	N3A
DEA1X3F181J□□□	3150	180 ±5%	11	7.5	6.0	A3B	B3B	N3A
DEA1X3F221J□□□	3150	220 ±5%	12	7.5	6.0	A3B	B3B	N3A
DEA1X3F271J□□□	3150	270 ±5%	14	7.5	6.0	A3B	B3B	N7A
DEA1X3F331J□□□	3150	330 ±5%	15	7.5	6.0	A3B	B3B	N7A
DEA1X3F391J□□□	3150	390 ±5%	16	7.5	6.0	A3B	B3B	N7A

Three blank columns are filled with the lead and packaging codes. Please refer to the three columns on the right for the appropriate code.

## DEA Series Specifications and Test Methods

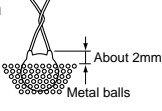
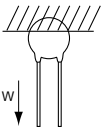
No.	Item		Specifications	Test Method									
1	Operating Temperature Range		-25 to +125°C										
2	Appearance and Dimensions		No marked defect on appearance form and dimensions are within specified range.	The capacitor should be visually inspected for evidence of defect. Dimensions should be measured with slide calipers.									
3	Marking		To be easily legible	The capacitor should be visually inspected.									
4	Dielectric Strength	Between Lead Wires	No failure	The capacitor should not be damaged when DC voltage of 200% of the rated voltage is applied between the lead wires for 1 to 5 sec. (Charge/Discharge currents ≤ 50mA)									
		Body Insulation	No failure	The capacitor is placed in the container with metal balls of diameter 1mm so that each lead wire, short circuited, is kept about 2mm off the metal balls as shown in the figure at right, and AC1250V(r.m.s.) <50/60Hz> is applied for 1 to 5 sec. between capacitor lead wires and metal balls. (Charge/Discharge current ≤ 50mA) 									
5	Insulation Resistance (I.R.)	Between Lead Wires	10000MΩ min.	The insulation resistance should be measured with DC500±50V within 60±5 sec. of charging.									
6	Capacitance		Within specified tolerance	The capacitance should be measured at 20°C with 1±0.2MHz and AC5V(r.m.s.) max.									
7	Q		400+20C*2min. (30pF under) 1000 min. (30pF min.)	The Q should be measured at 20°C with 1±0.2MHz and AC5V(r.m.s.) max.									
8	Temperature Characteristics		+350 to -1000ppm/°C (Temp. range: +20 to +85°C)	The capacitance measurement should be made at each step specified in Table.									
			<table border="1"> <thead> <tr> <th>Step</th> <th>1</th> <th>2</th> <th>3</th> <th>4</th> <th>5</th> </tr> </thead> <tbody> <tr> <td>Temp. (°C)</td> <td>20±2</td> <td>-25±3</td> <td>20±2</td> <td>85±2</td> <td>20±2</td> </tr> </tbody> </table>	Step	1	2	3	4	5	Temp. (°C)	20±2	-25±3	20±2
Step	1	2	3	4	5								
Temp. (°C)	20±2	-25±3	20±2	85±2	20±2								
9	Strength of Lead	Pull	Lead wire should not be cut off. Capacitor should not be broken.	As shown in the figure at right, fix the body of the capacitor and apply a tensile weight gradually to each lead wire in the radial direction of the capacitor up to 10N (5N for lead diameter 0.5mm), and keep it for 10±1 sec. 									
		Bending		Each lead wire should be subjected to 5N (2.5N for lead diameter 0.5mm) of weight and bent 90° at the point of egress, in one direction, then returned to its original position and bent 90° in the opposite direction at the rate of one bend in 2 to 3 sec.									
10	Vibration Resistance	Appearance	No marked defect	The capacitor should be firmly soldered to the supporting lead wire and vibrated at a frequency range of 10 to 55Hz, 1.5mm in total amplitude, with about a 1 minute rate of vibration change from 10Hz to 55Hz and back to 10Hz. Apply for a total of 6 hrs., 2 hrs. each in 3 mutually perpendicular directions.									
		Capacitance	Within specified tolerance										
		Q	400+20C*2min. (30pF under) 1000 min. (30pF min.)										
11	Solderability of Leads		Lead wire should be soldered with uniform coating on the axial direction over 3/4 of the circumferential direction.	The lead wire of a capacitor should be dipped into an ethanol solution of 25wt% rosin and then into molten solder for 2±0.5 sec. In both cases the depth of dipping is up to about 1.5 to 2mm from the root of lead wires. Temp. of solder: Lead Free Solder (Sn-3Ag-0.5Cu) 245±5°C H63 Eutectic Solder 235±5°C									
12	Soldering Effect (Non-Preheat)	Appearance	No marked defect	The lead wire should be immersed into the melted solder of 350±10°C (Body of ø5mm and under: 270±5°C) up to about 1.5 to 2mm from the main body for 3.5±0.5 sec. (Body of ø5mm and under: 5±0.5 sec.) Post-treatment: Capacitor should be stored for 1 to 2 hrs. at room condition*1.									
		Capacitance Change	Within ±2.5%										
		Dielectric Strength (Between Lead Wires)	Per item 4.										

\*1 "room condition" Temperature: 15 to 35°C, Relative humidity: 45 to 75%, Atmospheric pressure: 86 to 106kPa

\*2 "C" expresses nominal capacitance value (pF).

Continued on the following page. 

## DEA Series Specifications and Test Methods

Continued from the preceding page.

No.	Item	Specifications	Test Method															
13	Soldering Effect (On-Preheat)	Appearance	First the capacitor should be stored at 120+0/-5°C for 60+0/-5 sec. Then, as in figure, the lead wires should be immersed in solder of 260+0/-5°C up to 1.5 to 2.0mm from the root of terminal for 7.5+0/-1 sec. Post-treatment: Capacitor should be stored for 1 to 2 hrs. at room condition*1.															
		Capacitance Change		Within ±2.5%														
		Dielectric Strength (Between Lead Wires)		Per item 4.														
14	Temperature Cycle	Appearance	The capacitor should be subjected to 5 temperature cycles. <Temperature Cycle> <table border="1" style="margin: 10px auto;"> <thead> <tr> <th>Step</th> <th>Temperature (°C)</th> <th>Time (min)</th> </tr> </thead> <tbody> <tr> <td>1</td> <td>-25±3</td> <td>30</td> </tr> <tr> <td>2</td> <td>Room Temp.</td> <td>3</td> </tr> <tr> <td>3</td> <td>125±3</td> <td>30</td> </tr> <tr> <td>4</td> <td>Room Temp.</td> <td>3</td> </tr> </tbody> </table> Cycle time: 5 cycle Post-treatment: Capacitor should be stored for 1 to 2 hrs. at room condition*1.	Step	Temperature (°C)	Time (min)	1	-25±3	30	2	Room Temp.	3	3	125±3	30	4	Room Temp.	3
		Step		Temperature (°C)	Time (min)													
		1		-25±3	30													
		2		Room Temp.	3													
		3		125±3	30													
4	Room Temp.	3																
Capacitance Change	Within ±5%																	
Q	275+5/2C*2min. (30pF under) 350 min. (30pF min.)																	
I.R.	1000MΩ min.																	
Dielectric Strength (Between Lead Wires)	Per item 4.																	
15	Humidity (Under Steady State)	Appearance	Set the capacitor for 500+24/-0 hrs. at 40±2°C in 90 to 95% relative humidity. Post-treatment: Capacitor should be stored for 1 to 2 hrs. at room condition*1.															
		Capacitance Change		Within ±5%														
		Q		275+5/2C*2min. (30pF under) 350 min. (30pF min.)														
		I.R.		1000MΩ min.														
16	Humidity Loading	Appearance	Apply the rated voltage for 500+24/-0 hrs. at 40±2°C in 90 to 95% relative humidity. (Charge/Discharge current≤50mA) Post-treatment: Capacitor should be stored for 1 to 2 hrs. at room condition*1.															
		Capacitance Change		Within ±5%														
		Q		275+5/2C*2min. (30pF under) 350 min. (30pF min.)														
		I.R.		1000MΩ min.														
17	Life	Appearance	Apply a DC voltage of 150% of the rated voltage for 1000+48/-0 hrs. at 125±2°C with a relative humidity of 50% max. (Charge/Discharge current≤50mA) Post-treatment: Capacitor should be stored for 1 to 2 hrs. at room condition*1.															
		Capacitance Change		Within ±3%														
		Q		275+5/2C*2min. (30pF under) 350 min. (30pF min.)														
		I.R.		2000MΩ min.														

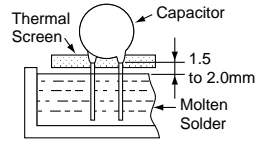

\*1 "room condition" Temperature: 15 to 35°C, Relative humidity: 45 to 75%, Atmospheric pressure: 86 to 106kPa

\*2 "C" expresses nominal capacitance value (pF).

# Safety Certified Ceramic Capacitors/High Voltage Ceramic Capacitors



## DEB Series (Class 2/DC1k-3.15kV)

### ■ Features

1. Small size and high capacitance
2. Coated with flame-retardant epoxy resin (equivalent to UL94V-0 standard).
3. Taping available for automatic insertion.

### ■ Applications

Ideal for use on decoupling circuits for power supplies.

Do not use these products in any Automotive Power train or Safety equipment including Battery charger for Electric Vehicles and Plug-in Hybrid. Only Murata products clearly stipulated as "for Automotive use" on its catalog can be used for automobile applications such as Power train and Safety equipment.

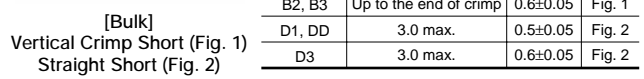
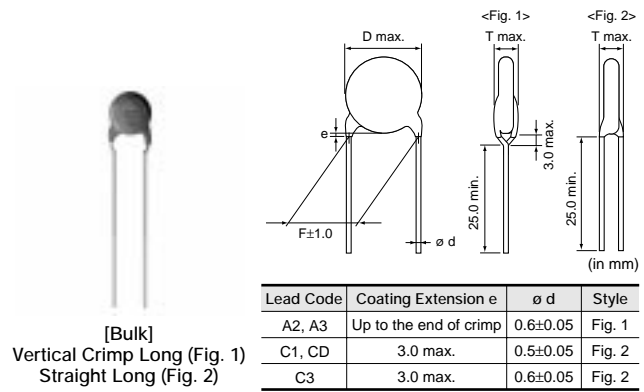

9

### ■ Marking

Nominal Body Diameter	Temp. Char.	B	E	F
	ø4.5-5mm		221 3KV	102 1KV
ø6mm		331 3KV 66	102 2KV 66	222 1KV 66
ø7-9mm		102K 3KV 66	102Z 3KV 66	472Z 2KV 66
ø10-16mm		B 332K 3KV M 66	E 472Z 3KV M 66	103Z 2KV M 66
Temperature Characteristics		Marked with code for char. B and E (omitted for nominal body diameter ø9mm and under)		
Nominal Capacitance		Marked with 3 figures		
Capacitance Tolerance		Marked with code (omitted for nominal body diameter ø6mm and under)		
Rated Voltage		Marked with code (In case of DC3.15kV, marked with 3KV)		
Manufacturer's Identification		Marked with M (omitted for nominal body diameter ø9mm and under)		
Manufactured Date Code		Abbreviation (omitted for nominal body diameter ø5mm and under)		

## B Characteristics

Part Number	DC Rated Voltage (V)	Capacitance (pF)	Body Dia. D (mm)	Lead Spacing F (mm)	Body Thickness T (mm)	Lead Package Long Bulk	Lead Package Short Bulk	Lead Package Taping
DEBB33A101K□□□	1000	100 ±10%	4.5	5.0	4.0	C1B	D1B	P2A
DEBB33A151K□□□	1000	150 ±10%	4.5	5.0	4.0	C1B	D1B	P2A
DEBB33A221K□□□	1000	220 ±10%	4.5	5.0	4.0	C1B	D1B	P2A
DEBB33A331K□□□	1000	330 ±10%	4.5	5.0	4.0	C1B	D1B	P2A
DEBB33A471K□□□	1000	470 ±10%	5	5.0	4.0	C1B	D1B	P2A
DEBB33A681K□□□	1000	680 ±10%	6	5.0	4.0	A2B	B2B	N2A
DEBB33A102K□□□	1000	1000 ±10%	6	5.0	4.0	A2B	B2B	N2A
DEBB33A152K□□□	1000	1500 ±10%	8	5.0	4.0	A2B	B2B	N2A
DEBB33A222K□□□	1000	2200 ±10%	9	5.0	4.0	A2B	B2B	N2A
DEBB33A332K□□□	1000	3300 ±10%	10	5.0	4.0	A2B	B2B	N2A
DEBB33A472K□□□	1000	4700 ±10%	12	7.5	4.0	A3B	B3B	N3A
DEBB33A682K□□□	1000	6800 ±10%	15	7.5	4.0	A3B	B3B	N7A
DEBB33D101K□□□	2000	100 ±10%	4.5	5.0	5.0	C1B	D1B	P2A
DEBB33D151K□□□	2000	150 ±10%	4.5	5.0	5.0	C1B	D1B	P2A
DEBB33D221K□□□	2000	220 ±10%	4.5	5.0	5.0	C1B	D1B	P2A
DEBB33D331K□□□	2000	330 ±10%	5	5.0	5.0	C1B	D1B	P2A
DEBB33D471K□□□	2000	470 ±10%	6	5.0	5.0	A2B	B2B	N2A
DEBB33D681K□□□	2000	680 ±10%	7	5.0	5.0	A2B	B2B	N2A
DEBB33D102K□□□	2000	1000 ±10%	8	5.0	5.0	A2B	B2B	N2A
DEBB33D152K□□□	2000	1500 ±10%	9	5.0	5.0	A2B	B2B	N2A
DEBB33D222K□□□	2000	2200 ±10%	10	5.0	5.0	A2B	B2B	N2A
DEBB33D332K□□□	2000	3300 ±10%	12	7.5	5.0	A3B	B3B	N3A
DEBB33D472K□□□	2000	4700 ±10%	15	7.5	5.0	A3B	B3B	N7A
DEBB33F101K□□□	3150	100 ±10%	5	7.5	6.0	CDB	DDB	P3A
DEBB33F151K□□□	3150	150 ±10%	5	7.5	6.0	CDB	DDB	P3A
DEBB33F221K□□□	3150	220 ±10%	5	7.5	6.0	CDB	DDB	P3A
DEBB33F331K□□□	3150	330 ±10%	6	7.5	6.0	C3B	D3B	P3A
DEBB33F471K□□□	3150	470 ±10%	7	7.5	6.0	C3B	D3B	P3A
DEBB33F681K□□□	3150	680 ±10%	8	7.5	6.0	A3B	B3B	N3A
DEBB33F102K□□□	3150	1000 ±10%	9	7.5	6.0	A3B	B3B	N3A
DEBB33F152K□□□	3150	1500 ±10%	11	7.5	6.0	A3B	B3B	N3A
DEBB33F222K□□□	3150	2200 ±10%	13	7.5	6.0	A3B	B3B	N3A
DEBB33F332K□□□	3150	3300 ±10%	15	7.5	6.0	A3B	B3B	N7A

Three blank columns are filled with the lead and packaging codes. Please refer to the three columns on the right for the appropriate code.

## E Characteristics

Part Number	DC Rated Voltage (V)	Capacitance (pF)	Body Dia. D (mm)	Lead Spacing F (mm)	Body Thickness T (mm)	Lead Package Long Bulk	Lead Package Short Bulk	Lead Package Taping
DEBE33A102Z□□□	1000	1000 +80/-20%	5	5.0	4.0	C1B	D1B	P2A
DEBE33A222Z□□□	1000	2200 +80/-20%	7	5.0	4.0	A2B	B2B	N2A
DEBE33A472Z□□□	1000	4700 +80/-20%	9	5.0	4.0	A2B	B2B	N2A
DEBE33A103Z□□□	1000	10000 +80/-20%	13	7.5	4.0	A3B	B3B	N3A
DEBE33D102Z□□□	2000	1000 +80/-20%	6	5.0	5.0	A2B	B2B	N2A
DEBE33D222Z□□□	2000	2200 +80/-20%	8	5.0	5.0	A2B	B2B	N2A
DEBE33D472Z□□□	2000	4700 +80/-20%	11	5.0	5.0	A2B	B2B	N2A
DEBE33D103Z□□□	2000	10000 +80/-20%	16	7.5	5.0	A3B	B3B	N7A
DEBE33F102Z□□□	3150	1000 +80/-20%	7	7.5	6.0	C3B	D3B	P3A
DEBE33F222Z□□□	3150	2200 +80/-20%	10	7.5	6.0	A3B	B3B	N3A
DEBE33F472Z□□□	3150	4700 +80/-20%	13	7.5	6.0	A3B	B3B	N3A

Three blank columns are filled with the lead and packaging codes. Please refer to the three columns on the right for the appropriate code.

⚠Note • This PDF catalog is downloaded from the website of Murata Manufacturing co., Ltd. Therefore, it's specifications are subject to change or our products in it may be discontinued without advance notice. Please check with our sales representatives or product engineers before ordering.  
 • This PDF catalog has only typical specifications because there is no space for detailed specifications. Therefore, please approve our product specifications or transact the approval sheet for product specifications before ordering.

## F Characteristics

Part Number	DC Rated Voltage (V)	Capacitance (pF)	Body Dia. D (mm)	Lead Spacing F (mm)	Body Thickness T (mm)	Lead Package Long Bulk	Lead Package Short Bulk	Lead Package Taping
DEBF33A222Z□□□	1000	2200 +80/-20%	6	5.0	4.0	A2B	B2B	N2A
DEBF33A472Z□□□	1000	4700 +80/-20%	7	5.0	4.0	A2B	B2B	N2A
DEBF33A103Z□□□	1000	10000 +80/-20%	10	5.0	4.0	A2B	B2B	N2A
DEBF33D102Z□□□	2000	1000 +80/-20%	5	5.0	5.0	C1B	D1B	P2A
DEBF33D222Z□□□	2000	2200 +80/-20%	7	5.0	5.0	A2B	B2B	N2A
DEBF33D472Z□□□	2000	4700 +80/-20%	9	5.0	5.0	A2B	B2B	N2A
DEBF33D103Z□□□	2000	10000 +80/-20%	12	7.5	5.0	A3B	B3B	N3A

Three blank columns are filled with the lead and packaging codes. Please refer to the three columns on the right for the appropriate code.

## DEB Series Specifications and Test Methods

No.	Item		Specifications	Test Method												
1	Operating Temperature Range		-25 to +85°C													
2	Appearance and Dimensions		No marked defect on appearance form and dimensions are within specified range.	The capacitor should be visually inspected for evidence of defect. Dimensions should be measured with slide calipers.												
3	Marking		To be easily legible	The capacitor should be visually inspected.												
4	Dielectric Strength	Between Lead Wires	No failure	The capacitor should not be damaged when DC voltage of 200% of the rated voltage is applied between the lead wires for 1 to 5 sec. (Charge/Discharge current ≤ 50mA)												
		Body Insulation	No failure	The capacitor is placed in the container with metal balls of diameter 1mm so that each lead wire, short circuited, is kept about 2mm off the metal balls as shown in the figure at right, and DC voltage of 1.3kV is applied for 1 to 5 sec. between capacitor lead wires and metal balls. (Charge/Discharge current ≤ 50mA)												
5	Insulation Resistance (I.R.)	Between Lead Wires	10000MΩ min.	The insulation resistance should be measured with DC500±50V within 60±5 sec. of charging.												
6	Capacitance		Within specified tolerance	The capacitance should be measured at 20°C with 1±0.2kHz and AC5V(r.m.s.) max.												
7	Dissipation Factor (D.F.)		Char. B, E: 2.5% max. Char. F: 5.0% max.	The dissipation factor should be measured at 20°C with 1±0.2kHz and AC5V(r.m.s.) max.												
8	Temperature Characteristics		Char. B: Within ±10% Char. E: Within +20/-55% Char. F: Within +30/-80%	The capacitance measurement should be made at each step specified in Table.												
			Pre-treatment: Capacitor should be stored at 85±2°C for 1 hr., then placed at room condition* for 24±2 hrs. before measurements.													
			<table border="1"> <thead> <tr> <th>Step</th> <th>1</th> <th>2</th> <th>3</th> <th>4</th> <th>5</th> </tr> </thead> <tbody> <tr> <td>Temp. (°C)</td> <td>20±2</td> <td>-25±3</td> <td>20±2</td> <td>85±2</td> <td>20±2</td> </tr> </tbody> </table>	Step	1	2	3	4	5	Temp. (°C)	20±2	-25±3	20±2	85±2	20±2	
Step	1	2	3	4	5											
Temp. (°C)	20±2	-25±3	20±2	85±2	20±2											
9	Strength of Lead	Pull	Lead wire should not be cut off. Capacitor should not be broken.	As shown in the figure at right, fix the body of the capacitor and apply a tensile weight gradually to each lead wire in the radial direction of the capacitor up to 10N (5N for lead diameter 0.5mm), and keep it for 10±1 sec.												
		Bending		Each lead wire should be subjected to 5N (2.5N for lead diameter 0.5mm) of weight and bent 90° at the point of egress, in one direction, then returned to its original position and bent 90° in the opposite direction at the rate of one bend in 2 to 3 sec.												
10	Vibration Resistance	Appearance	No marked defect	The capacitor should be firmly soldered to the supporting lead wire and vibrated at a frequency range of 10 to 55Hz, 1.5mm in total amplitude, with about a 1 minute rate of vibration change from 10Hz to 55Hz and back to 10Hz. Apply for a total of 6 hrs., 2 hrs. each in 3 mutually perpendicular directions.												
		Capacitance	Within specified tolerance													
		D.F.	Char. B, E: 2.5% max. Char. F: 5.0% max.													
11	Solderability of Leads		Lead wire should be soldered with uniform coating on the axial direction over 3/4 of the circumferential direction.	The lead wire of a capacitor should be dipped into a ethanol solution of 25wt% rosin and then into molten solder for 2±0.5 sec. In both cases the depth of dipping is up to about 1.5 to 2mm from the root of lead wires. Temp. of solder: Lead Free Solder (Sn-3Ag-0.5Cu) 245±5°C H63 Eutectic Solder 235±5°C												
12	Soldering Effect (Non-Preheat)	Appearance	No marked defect	The lead wire should be immersed into the melted solder of 350±10°C (Body of ø5mm and under: 270±5°C) up to about 1.5 to 2mm from the main body for 3.5±0.5 sec. (Body of ø5mm and under: 5±0.5 sec.) Pre-treatment: Capacitor should be stored at 85±2°C for 1 hr., then placed at room condition* for 24±2 hrs. before initial measurements. Post-treatment: Capacitor should be stored for 4 to 24 hrs. at room condition*.												
		Capacitance Change	Char. B: Within ±5% Char. E: Within ±15% Char. F: Within ±20%													
		Dielectric Strength (Between Lead Wires)	Per item 4.													

\* "room condition" Temperature: 15 to 35°C, Relative humidity: 45 to 75%, Atmospheric pressure: 86 to 106kPa

Continued on the following page.

## DEB Series Specifications and Test Methods

Continued from the preceding page.

No.	Item	Specifications	Test Method																											
13	Appearance	No marked defect	First the capacitor should be stored at 120+0/-5°C for 60+0/-5 sec. Then, as in figure, the lead wires should be immersed in solder of 260+0/-5°C up to 1.5 to 2.0mm from the root of terminal for 7.5+0/-1 sec. Pre-treatment: Capacitor should be stored at 85±2°C for 1 hr., then placed at room condition* for 24±2 hrs. before initial measurements. Post-treatment: Capacitor should be stored for 4 to 24 hrs. at room condition*.																											
	Capacitance Change	Char. B: Within ±5% Char. E: Within ±15% Char. F: Within ±20%																												
	Dielectric Strength (Between Lead Wires)	Per item 4.																												
14	Appearance	No marked defect	The capacitor should be subjected to 5 temperature cycles, then consecutively to 2 immersion cycles. <Temperature Cycle> <table border="1" style="margin-left: 20px;"> <thead> <tr> <th>Step</th> <th>Temperature (°C)</th> <th>Time (min)</th> </tr> </thead> <tbody> <tr> <td>1</td> <td>-25±3</td> <td>30</td> </tr> <tr> <td>2</td> <td>Room Temp.</td> <td>3</td> </tr> <tr> <td>3</td> <td>85±3</td> <td>30</td> </tr> <tr> <td>4</td> <td>Room Temp.</td> <td>3</td> </tr> </tbody> </table> Cycle time: 5 cycle <Immersion Cycle> <table border="1" style="margin-left: 20px;"> <thead> <tr> <th>Step</th> <th>Temperature (°C)</th> <th>Time (min)</th> <th>Immersion Water</th> </tr> </thead> <tbody> <tr> <td>1</td> <td>65+5/-0</td> <td>15</td> <td>Clean water</td> </tr> <tr> <td>2</td> <td>0±3</td> <td>15</td> <td>Salt water</td> </tr> </tbody> </table> Cycle time : 2 cycle Pre-treatment: Capacitor should be stored at 85±2°C for 1 hr., then placed at room condition* for 24±2 hrs. before initial measurements. Post-treatment: Capacitor should be stored for 4 to 24 hrs. at room condition*.	Step	Temperature (°C)	Time (min)	1	-25±3	30	2	Room Temp.	3	3	85±3	30	4	Room Temp.	3	Step	Temperature (°C)	Time (min)	Immersion Water	1	65+5/-0	15	Clean water	2	0±3	15	Salt water
	Step	Temperature (°C)		Time (min)																										
	1	-25±3		30																										
	2	Room Temp.		3																										
	3	85±3		30																										
4	Room Temp.	3																												
Step	Temperature (°C)	Time (min)	Immersion Water																											
1	65+5/-0	15	Clean water																											
2	0±3	15	Salt water																											
Capacitance Change	Char. B: Within ±10% Char. E: Within ±20% Char. F: Within ±30%																													
D.F.	Char. B, E: 4.0% max. Char. F: 7.5% max.																													
I.R.	2000MΩ min.																													
Dielectric Strength (Between Lead Wires)	Per item 4.																													
15	Appearance	No marked defect	Set the capacitor for 500+24/-0 hrs. at 40±2°C in 90 to 95% relative humidity. Pre-treatment: Capacitor should be stored at 85±2°C for 1 hr., then placed at room condition* for 24±2 hrs. before initial measurements. Post-treatment: Capacitor should be stored for 1 to 2 hrs. at room condition*.																											
	Capacitance Change	Char. B: Within ±10% Char. E: Within ±20% Char. F: Within ±30%																												
	D.F.	Char. B, E: 5.0% max. Char. F: 7.5% max.																												
	I.R.	1000MΩ min.																												
16	Appearance	No marked defect	Apply the rated voltage for 500+24/-0 hrs. at 40±2°C in 90 to 95% relative humidity. (Charge/Discharge current≤50mA) Pre-treatment: Capacitor should be stored at 85±2°C for 1 hr., then placed at room condition* for 24±2 hrs. before initial measurements. Post-treatment: Capacitor should be stored at 85±2°C for 1 hr., then placed at room condition* for 24±2 hrs.																											
	Capacitance Change	Char. B: Within ±10% Char. E: Within ±20% Char. F: Within ±30%																												
	D.F.	Char. B, E: 5.0% max. Char. F: 7.5% max.																												
	I.R.	500MΩ min.																												
17	Appearance	No marked defect	Apply a DC voltage of 150% of the rated voltage for 1000+48/-0 hrs. at 85±2°C with a relative humidity of 50% max. (Charge/Discharge current≤50mA) Pre-treatment: Capacitor should be stored at 85±2°C for 1 hr., then placed at room condition* for 24±2 hrs. before initial measurements. Post-treatment: Capacitor should be stored at 85±2°C for 1 hr., then placed at room condition* for 24±2 hrs.																											
	Capacitance Change	Char. B: Within ±10% Char. E: Within ±20% Char. F: Within ±30%																												
	D.F.	Char. B, E: 4.0% max. Char. F: 7.5% max.																												
	I.R.	2000MΩ min.																												

\* "room condition" Temperature: 15 to 35°C, Relative humidity: 45 to 75%, Atmospheric pressure: 86 to 106kPa

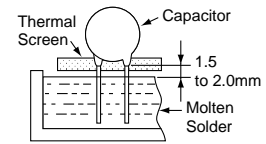

# Safety Certified Ceramic Capacitors/High Voltage Ceramic Capacitors



## DEC Series (Class 1, 2/DC6.3kV)

### ■ Features

Coated with flame-retardant epoxy resin (equivalent to UL94V-0 standard).

### ■ Applications

1. Ideal for use as the ballast in back lighting inverters for liquid crystal displays (SL Char.).
2. Ideal for use on high voltage circuits such as Cockcroft circuits (B Char.).

Do not use these products in any Automotive Power train or Safety equipment including Battery charger for Electric Vehicles and Plug-in Hybrid. Only Murata products clearly stipulated as "for Automotive use" on its catalog can be used for automobile applications such as Power train and Safety equipment.

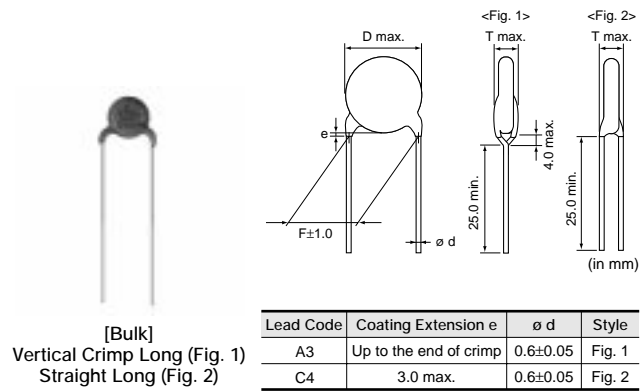

### ■ Marking

Temp. Char.	SL	B	E
Nominal Body Diameter			
ø7mm	10J 6KV	_____	_____
ø8-9mm	47J 6KV 66	331K 6KV 66	_____
ø10-15mm	151J 6KV M66	B 102K 6KV M66	222Z 6KV M66
Temperature Characteristics	Marked with code for char. B (omitted for nominal body diameter ø9mm and under)		
Nominal Capacitance	Under 100pF: Actual value, 100pF and over: Marked with 3 figures		
Capacitance Tolerance	Marked with code		
Rated Voltage	Marked with code (In case of DC6.3kV, marked with 6KV)		
Manufacturer's Identification	Marked with M (omitted for nominal body diameter ø9mm and under)		
Manufactured Date Code	Abbreviation (omitted for nominal body diameter ø7mm)		

10

### SL Characteristics

Part Number	DC Rated Voltage (V)	Capacitance (pF)	Body Dia. D (mm)	Lead Spacing F (mm)	Body Thickness T (mm)
DEC1X3J100JA3BMS1	6300	10 ±5%	7	7.5	7.0
DEC1X3J100JC4BMS1	6300	10 ±5%	7	10.0	7.0
DEC1X3J120JA3B	6300	12 ±5%	8	7.5	7.0
DEC1X3J120JC4B	6300	12 ±5%	8	10.0	7.0
DEC1X3J150JA3B	6300	15 ±5%	8	7.5	7.0
DEC1X3J150JC4B	6300	15 ±5%	8	10.0	7.0
DEC1X3J180JA3B	6300	18 ±5%	9	7.5	7.0
DEC1X3J180JC4B	6300	18 ±5%	9	10.0	7.0
DEC1X3J220JA3B	6300	22 ±5%	9	7.5	7.0
DEC1X3J220JC4B	6300	22 ±5%	9	10.0	7.0

Continued on the following page.



△Note • This PDF catalog is downloaded from the website of Murata Manufacturing co., Ltd. Therefore, it's specifications are subject to change or our products in it may be discontinued without advance notice. Please check with our sales representatives or product engineers before ordering.  
 • This PDF catalog has only typical specifications because there is no space for detailed specifications. Therefore, please approve our product specifications or transact the approval sheet for product specifications before ordering.

Continued from the preceding page.

Part Number	DC Rated Voltage (V)	Capacitance (pF)	Body Dia. D (mm)	Lead Spacing F (mm)	Body Thickness T (mm)
DEC1X3J270JA3B	6300	27 ±5%	9	7.5	7.0
DEC1X3J270JC4B	6300	27 ±5%	9	10.0	7.0
DEC1X3J330JA3B	6300	33 ±5%	9	7.5	7.0
DEC1X3J330JC4B	6300	33 ±5%	9	10.0	7.0
DEC1X3J390JA3B	6300	39 ±5%	9	7.5	7.0
DEC1X3J390JC4B	6300	39 ±5%	9	10.0	7.0
DEC1X3J470JA3B	6300	47 ±5%	9	7.5	7.0
DEC1X3J470JC4B	6300	47 ±5%	9	10.0	7.0
DEC1X3J560JC4B	6300	56 ±5%	10	10.0	7.0
DEC1X3J680JC4B	6300	68 ±5%	12	10.0	7.0
DEC1X3J820JC4B	6300	82 ±5%	12	10.0	7.0
DEC1X3J101JC4B	6300	100 ±5%	13	10.0	7.0
DEC1X3J121JC4B	6300	120 ±5%	14	10.0	7.0
DEC1X3J151JC4B	6300	150 ±5%	15	10.0	7.0

### B Characteristics

Part Number	DC Rated Voltage (V)	Capacitance (pF)	Body Dia. D (mm)	Lead Spacing F (mm)	Body Thickness T (mm)
DECB33J101KC4B	6300	100 ±10%	9	10.0	7.0
DECB33J151KC4B	6300	150 ±10%	9	10.0	7.0
DECB33J221KC4B	6300	220 ±10%	9	10.0	7.0
DECB33J331KC4B	6300	330 ±10%	9	10.0	7.0
DECB33J471KC4B	6300	470 ±10%	10	10.0	7.0
DECB33J681KC4B	6300	680 ±10%	11	10.0	7.0
DECB33J102KC4B	6300	1000 ±10%	13	10.0	7.0

### E Characteristics

Part Number	DC Rated Voltage (V)	Capacitance (pF)	Body Dia. D (mm)	Lead Spacing F (mm)	Body Thickness T (mm)
DECE33J102ZC4B	6300	1000 +80/-20%	11	10.0	7.0
DECE33J222ZC4B	6300	2200 +80/-20%	15	10.0	7.0

## DEC Series Specifications and Test Methods

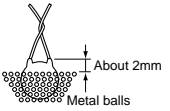
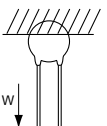
No.	Item		Specifications	Test Method												
1	Operating Temperature Range		-25 to +85°C													
2	Appearance and Dimensions		No marked defect on appearance form and dimensions are within specified range.	The capacitor should be visually inspected for evidence of defect. Dimensions should be measured with slide calipers.												
3	Marking		To be easily legible	The capacitor should be visually inspected.												
4	Dielectric Strength	Between Lead Wires	No failure	The capacitor should not be damaged when DC voltage of 200% of the rated voltage is applied between the lead wires for 1 to 5 sec. (Charge/Discharge current ≤ 50mA)												
		Body Insulation	No failure	The capacitor is placed in the container with metal balls of diameter 1mm so that each lead wire, short circuited, is kept about 2mm off the metal balls as shown in the figure at right, and DC voltage of 1.3kV is applied for 1 to 5 sec. between capacitor lead wires and metal balls. (Charge/Discharge current ≤ 50mA) 												
5	Insulation Resistance (I.R.)	Between Lead Wires	10000MΩ min.	The insulation resistance should be measured with DC500±50V within 60±5 sec. of charging.												
6	Capacitance		Within specified tolerance	The capacitance should be measured at 20°C with 1±0.2kHz (Char. SL: 1±0.2MHz) and AC5V(r.m.s.) max.												
7	Q		Char. SL: 400+20C <sup>+2</sup> min. (30pF under) 1000 min. (30pF min.)	The dissipation factor and Q should be measured at 20°C with 1±0.2kHz (Char. SL: 1±0.2MHz) and AC5V(r.m.s.) max.												
	Dissipation Factor (D.F.)		Char. B, E: 2.5% max.													
8	Temperature Characteristics		Char. SL: +350 to -1000ppm/°C (Temp. range: +20 to +85°C) Char. B: Within ±10% Char. E: Within +20/-55%	The capacitance measurement should be made at each step specified in Table.												
			Pre-treatment: Capacitor should be stored at 85±2°C for 1 hr., then placed at room condition*1 for 24±2 hrs. before measurements. (Char. B, E)													
			<table border="1" style="margin-left: auto; margin-right: auto;"> <thead> <tr> <th>Step</th> <th>1</th> <th>2</th> <th>3</th> <th>4</th> <th>5</th> </tr> </thead> <tbody> <tr> <td>Temp. (°C)</td> <td>20±2</td> <td>-25±3</td> <td>20±2</td> <td>85±2</td> <td>20±2</td> </tr> </tbody> </table>	Step	1	2	3	4	5	Temp. (°C)	20±2	-25±3	20±2	85±2	20±2	
Step	1	2	3	4	5											
Temp. (°C)	20±2	-25±3	20±2	85±2	20±2											
9	Strength of Lead	Pull	Lead wire should not be cut off. Capacitor should not be broken.	As shown in the figure at right, fix the body of the capacitor and apply a tensile weight gradually to each lead wire in the radial direction of the capacitor up to 10N and keep it for 10±1 sec. 												
		Bending		Each lead wire should be subjected to 5N of weight and bent 90° at the point of egress, in one direction, then returned to its original position and bent 90° in the opposite direction at the rate of one bend in 2 to 3 sec.												
10	Vibration Resistance	Appearance	No marked defect	The capacitor should be firmly soldered to the supporting lead wire and vibrated at a frequency range of 10 to 55Hz, 1.5mm in total amplitude, with about a 1 minute rate of vibration change from 10Hz to 55Hz and back to 10Hz. Apply for a total of 6 hrs., 2 hrs. each in 3 mutually perpendicular directions.												
		Capacitance	Within specified tolerance													
		Q	Char. SL: 400+20C <sup>+2</sup> min. (30pF under) 1000 min. (30pF min.)													
		D.F.	Char. B, E: 2.5% max.													
11	Solderability of Leads		Lead wire should be soldered with uniform coating on the axial direction over 3/4 of the circumferential direction.	The lead wire of a capacitor should be dipped into a ethanol solution of 25wt% rosin and then into molten solder for 2±0.5 sec. In both cases the depth of dipping is up to about 1.5 to 2mm from the root of lead wires. Temp. of solder: Lead Free Solder (Sn-3Ag-0.5Cu) 245±5°C H63 Eutectic Solder 235±5°C												
12	Soldering Effect (Non-Preheat)	Appearance	No marked defect	The lead wire should be immersed into the melted solder of 350±10°C up to about 1.5 to 2mm from the main body for 3.5±0.5 sec. Pre-treatment: Capacitor should be stored at 85±2°C for 1 hr., then placed at room condition*1 for 24±2 hrs. before initial measurements. (Char. B, E) Post-treatment: Capacitor should be stored for 1 to 2 hrs. at room condition*1. (Char. SL) Post-treatment: Capacitor should be stored for 4 to 24 hrs. at room condition*1. (Char. B, E)												
		Capacitance Change	Char. SL: Within ±2.5% Char. B: Within ±5% Char. E: Within ±15%													
		Dielectric Strength (Between Lead Wires)	Per item 4.													

\*1 "room condition" Temperature: 15 to 35°C, Relative humidity: 45 to 75%, Atmospheric pressure: 86 to 106kPa

\*2 "C" expresses nominal capacitance value (pF).

Continued on the following page. 

## DEC Series Specifications and Test Methods

Continued from the preceding page.

No.	Item	Specifications	Test Method																											
13	Appearance	No marked defect	First the capacitor should be stored at 120+0/-5°C for 60+0/-5 sec. Then, as in figure, the lead wires should be immersed in solder of 260+0/-5°C up to 1.5 to 2.0mm from the root of terminal for 7.5+0/-1 sec. Pre-treatment: Capacitor should be stored at 85±2°C for 1 hr., then placed at room condition*1 for 24±2 hrs. before initial measurements. (Char. B, E) Post-treatment: Capacitor should be stored for 1 to 2 hrs. at room condition*1. (Char. SL) Post-treatment: Capacitor should be stored for 4 to 24 hrs. at room condition*1. (Char. B, E)																											
	Capacitance Change	Char. SL: Within ±2.5% Char. B: Within ±5% Char. E: Within ±15%																												
	Dielectric Strength (Between Lead Wires)	Per item 4.																												
14	Appearance	No marked defect	The capacitor should be subjected to 5 temperature cycles, then consecutively to 2 immersion cycles. <Temperature Cycle> <table border="1" style="margin-left: 20px;"> <thead> <tr> <th>Step</th> <th>Temperature (°C)</th> <th>Time (min)</th> </tr> </thead> <tbody> <tr> <td>1</td> <td>-25±3</td> <td>30</td> </tr> <tr> <td>2</td> <td>Room Temp.</td> <td>3</td> </tr> <tr> <td>3</td> <td>85±3</td> <td>30</td> </tr> <tr> <td>4</td> <td>Room Temp.</td> <td>3</td> </tr> </tbody> </table> Cycle time: 5 cycle <Immersion Cycle> <table border="1" style="margin-left: 20px;"> <thead> <tr> <th>Step</th> <th>Temperature (°C)</th> <th>Time (min)</th> <th>Immersion Water</th> </tr> </thead> <tbody> <tr> <td>1</td> <td>65+5/-0</td> <td>15</td> <td>Clean water</td> </tr> <tr> <td>2</td> <td>0±3</td> <td>15</td> <td>Salt water</td> </tr> </tbody> </table> Cycle time: 2 cycle Pre-treatment: Capacitor should be stored at 85±2°C for 1 hr., then placed at room condition*1 for 24±2 hrs. before initial measurements. (Char. B, E) Post-treatment: Capacitor should be stored for 4 to 24 hrs. at room condition*1.	Step	Temperature (°C)	Time (min)	1	-25±3	30	2	Room Temp.	3	3	85±3	30	4	Room Temp.	3	Step	Temperature (°C)	Time (min)	Immersion Water	1	65+5/-0	15	Clean water	2	0±3	15	Salt water
	Step	Temperature (°C)		Time (min)																										
	1	-25±3		30																										
	2	Room Temp.		3																										
	3	85±3		30																										
	4	Room Temp.		3																										
Step	Temperature (°C)	Time (min)	Immersion Water																											
1	65+5/-0	15	Clean water																											
2	0±3	15	Salt water																											
Capacitance Change	Char. SL: Within ±3% Char. B: Within ±10% Char. E: Within ±20%																													
Q	Char. SL: 275+5/2C*2min. (30pF under) 350 min. (30pF min.)																													
D.F.	Char. B, E: 4.0% max.																													
I.R.	2000MΩ min.																													
Dielectric Strength (Between Lead Wires)	Per item 4.																													
15	Appearance	No marked defect	Set the capacitor for 500+24/-0 hrs. at 40±2°C in 90 to 95% relative humidity. Pre-treatment: Capacitor should be stored at 85±2°C for 1 hr., then placed at room condition*1 for 24±2 hrs. before initial measurements. (Char. B, E) Post-treatment: Capacitor should be stored for 1 to 2 hrs. at room condition*1.																											
	Capacitance Change	Char. SL: Within ±5% Char. B: Within ±10% Char. E: Within ±20%																												
	Q	Char. SL: 275+5/2C*2min. (30pF under) 350 min. (30pF min.)																												
	D.F.	Char. B, E: 5.0% max.																												
	I.R.	1000MΩ min.																												
16	Appearance	No marked defect	Apply the rated voltage for 500+24/-0 hrs. at 40±2°C in 90 to 95% relative humidity. (Charge/Discharge current≤50mA.) Pre-treatment: Capacitor should be stored at 85±2°C for 1 hr., then placed at room condition*1 for 24±2 hrs. before initial measurements. (Char. B, E) Post-treatment: Capacitor should be stored for 1 to 2 hrs. at room condition*1. (Char. SL) Post-treatment: Capacitor should be stored at 85±2°C for 1 hr., then placed at room condition*1 for 24±2 hrs. (Char. B, E)																											
	Capacitance Change	Char. SL: Within ±7.5% Char. B: Within ±10% Char. E: Within ±20%																												
	Q	Char. SL: 100+10/3C*2min. (30pF under) 200 min. (30pF min.)																												
	D.F.	Char. B, E: 5.0% max.																												
	I.R.	500MΩ min.																												
17	Appearance	No marked defect	Apply a DC voltage of 150% of the rated voltage for 1000+48/-0 hrs. at 85±2°C with a relative humidity of 50% max. (Charge/Discharge current≤50mA.) Pre-treatment: Capacitor should be stored at 85±2°C for 1 hr., then placed at room condition*1 for 24±2 hrs. before initial measurements. (Char. B, E) Post-treatment: Capacitor should be stored for 1 to 2 hrs. at room condition*1. (Char. SL) Post-treatment: Capacitor should be stored at 85±2°C for 1 hr., then placed at room condition*1 for 24±2 hrs. (Char. B, E)																											
	Capacitance Change	Char. SL: Within ±3% Char. B: Within ±10% Char. E: Within ±20%																												
	Q	Char. SL: 275+5/2C*2min. (30pF under) 350 min. (30pF min.)																												
	D.F.	Char. B, E: 4.0% max.																												
	I.R.	2000MΩ min.																												

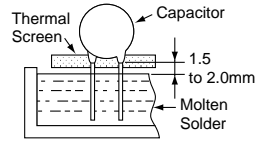

\*1 "room condition" Temperature: 15 to 35°C, Relative humidity: 45 to 75%, Atmospheric pressure: 86 to 106kPa

\*2 "C" expresses nominal capacitance value (pF).

# Safety Certified Ceramic Capacitors/High Voltage Ceramic Capacitors



## DEF Series (Only for LCD Backlight Inverter Circuit/6.3kVp-p)

### ■ Features

1. We design capacitors in much more compact size than DEC series, having reduced the diameter by 20% max.
2. Low self-heating at high frequency and high voltage due to low dielectric loss of the ceramic material.
3. Operating temperature range is guaranteed up to 105 degrees C.
4. Coated with flame-retardant epoxy resin (equivalent to UL94V-0 standard).
5. Taping available for automatic insertion.

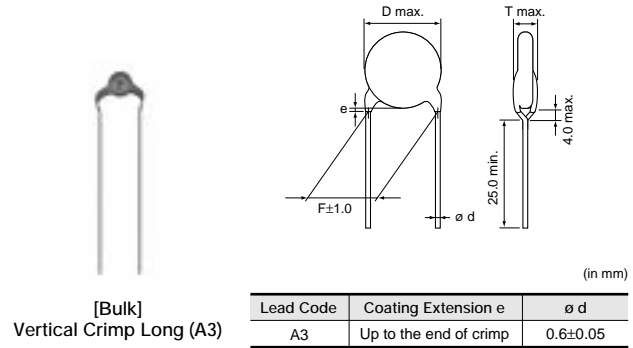

### ■ Applications

Ideal for use in LCD backlight inverter.

Do not use these products in any Automotive Power train or Safety equipment including Battery charger for Electric Vehicles and Plug-in Hybrid. Only Murata products clearly stipulated as "for Automotive use" on its catalog can be used for automobile applications such as Power train and Safety equipment.

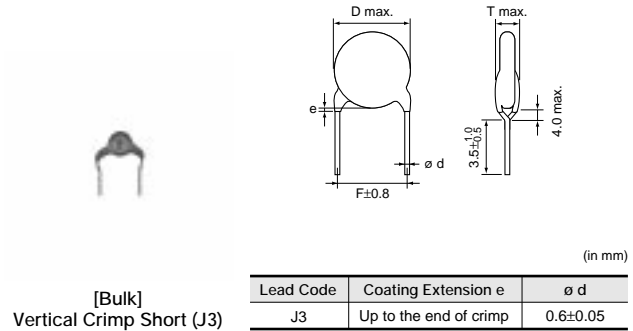

### ■ Marking

Temp. Char.	CH		SL
	Nominal Body Diameter		
ø7-9mm			
Temperature Characteristics	Upper horizontal line		-
Nominal Capacitance	Actual value		
Capacitance Tolerance	Marked with code		
Rated Voltage	Marked with code (Marked with 6K~)		
Manufactured Date Code	Abbreviation		

### SL Characteristics

Part Number	Rated Voltage (Vp-p)	Capacitance (pF)	Body Dia. D (mm)	Lead Spacing F (mm)	Body Thickness T (mm)	Lead Package Long Bulk	Lead Package Short Bulk	Lead Package Taping
DEF1XLH100J□□□	6300	10 ±5%	7	7.5	6.0	A3B	J3B	N3A
DEF1XLH120J□□□	6300	12 ±5%	7	7.5	6.0	A3B	J3B	N3A
DEF1XLH150J□□□	6300	15 ±5%	7	7.5	6.0	A3B	J3B	N3A
DEF1XLH180J□□□	6300	18 ±5%	7	7.5	6.0	A3B	J3B	N3A
DEF1XLH220J□□□	6300	22 ±5%	7	7.5	6.0	A3B	J3B	N3A
DEF1XLH270J□□□	6300	27 ±5%	8	7.5	6.0	A3B	J3B	N3A
DEF1XLH330J□□□	6300	33 ±5%	9	7.5	6.0	A3B	J3B	N3A
DEF1XLH390J□□□	6300	39 ±5%	9	7.5	6.0	A3B	J3B	N3A
DEF1XLH470J□□□	6300	47 ±5%	9	7.5	6.0	A3B	J3B	N3A

Three blank columns are filled with the lead and packaging codes. Please refer to the three columns on the right for the appropriate code.



⚠Note • This PDF catalog is downloaded from the website of Murata Manufacturing co., Ltd. Therefore, it's specifications are subject to change or our products in it may be discontinued without advance notice. Please check with our sales representatives or product engineers before ordering.  
 • This PDF catalog has only typical specifications because there is no space for detailed specifications. Therefore, please approve our product specifications or transact the approval sheet for product specifications before ordering.

### CH Characteristics

Part Number	Rated Voltage (Vp-p)	Capacitance (pF)	Body Dia. D (mm)	Lead Spacing F (mm)	Body Thickness T (mm)	Lead Package Long Bulk	Lead Package Short Bulk	Lead Package Taping
DEF2CLH020C□□□□	6300	2 ±0.25pF	7	7.5	6.0	A3B	J3B	N3A
DEF2CLH030C□□□□	6300	3 ±0.25pF	7	7.5	6.0	A3B	J3B	N3A
DEF2CLH040C□□□□	6300	4 ±0.25pF	7	7.5	6.0	A3B	J3B	N3A
DEF2CLH050D□□□□	6300	5 ±0.5pF	7	7.5	6.0	A3B	J3B	N3A
DEF2CLH060D□□□□	6300	6 ±0.5pF	7	7.5	6.0	A3B	J3B	N3A
DEF2CLH070D□□□□	6300	7 ±0.5pF	8	7.5	6.0	A3B	J3B	N3A
DEF2CLH080D□□□□	6300	8 ±0.5pF	8	7.5	6.0	A3B	J3B	N3A
DEF2CLH090D□□□□	6300	9 ±0.5pF	8	7.5	6.0	A3B	J3B	N3A
DEF2CLH100J□□□□	6300	10 ±5%	8	7.5	6.0	A3B	J3B	N3A

Three blank columns are filled with the lead and packaging codes. Please refer to the three columns on the right for the appropriate code.

## DEF Series Specifications and Test Methods

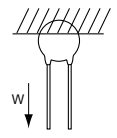
No.	Item		Specifications	Test Method									
1	Operating Temperature Range		-25 to +105°C										
2	Appearance and Dimensions		No marked defect on appearance form and dimensions are within specified range.	The capacitor should be visually inspected for evidence of defect. Dimensions should be measured with slide calipers.									
3	Marking		To be easily legible	The capacitor should be visually inspected.									
4	Dielectric Strength	Between Lead Wires	No failure	The capacitor should not be damaged when DC12.6kV is applied between the lead wires for 1 to 5 sec. (Charge/Discharge current ≤ 50mA)									
		Body Insulation	No failure	The capacitor is placed in the container with metal balls of diameter 1mm so that each lead wire, short circuited, is kept about 2.0mm off the metal balls as shown in the figure at right, and DC voltage of 1.3kV is applied for 1 to 5 sec. between capacitor lead wires and metal balls. (Charge/Discharge current ≤ 50mA)									
5	Insulation Resistance (I.R.)	Between Lead Wires	10000MΩ min.	The insulation resistance should be measured with DC500±50V within 60±5 sec. of charging.									
6	Capacitance		Within specified tolerance	The capacitance should be measured at 20°C with 1±0.2MHz and AC5V(r.m.s.) max.									
7	Q		400+20C* <sup>2</sup> min. (30pF under) 1000 min. (30pF min.)	The Q should be measured at 20°C with 1±0.2MHz and AC5V(r.m.s.) max.									
8	Temperature Characteristics		Char. CH: 0±60ppm/°C Char. SL: +350 to -1000ppm/°C (Temp. range: +20 to +85°C)	The capacitance measurement should be made at each step specified in Table.									
			<table border="1" style="margin-left: auto; margin-right: auto;"> <thead> <tr> <th>Step</th> <th>1</th> <th>2</th> <th>3</th> <th>4</th> <th>5</th> </tr> </thead> <tbody> <tr> <td>Temp. (°C)</td> <td>20±2</td> <td>-25±3</td> <td>20±2</td> <td>85±2</td> <td>20±2</td> </tr> </tbody> </table>	Step	1	2	3	4	5	Temp. (°C)	20±2	-25±3	20±2
Step	1	2	3	4	5								
Temp. (°C)	20±2	-25±3	20±2	85±2	20±2								
9	Strength of Lead	Pull	Lead wire should not be cut off. Capacitor should not be broken.	As shown in the figure at right, fix the body of the capacitor and apply a tensile weight gradually to each lead wire in the radial direction of the capacitor up to 10N and keep it for 10±1 sec. 									
		Bending		Each lead wire should be subjected to 5N of weight and bent 90° at the point of egress, in one direction, then returned to its original position and bent 90° in the opposite direction at the rate of one bend in 2 to 3 sec.									
10	Vibration Resistance	Appearance	No marked defect	The capacitor should be firmly soldered to the supporting lead wire and vibrated at a frequency range of 10 to 55Hz, 1.5mm in total amplitude, with about a 1 minute rate of vibration change from 10Hz to 55Hz and back to 10Hz. Apply for a total of 6 hrs., 2 hrs. each in 3 mutually perpendicular directions.									
		Capacitance	Within specified tolerance										
		Q	400+20C* <sup>2</sup> min. (30pF under) 1000 min. (30pF min.)										
11	Solderability of Leads		Lead wire should be soldered with uniform coating on the axial direction over 3/4 of the circumferential direction.	The lead wire of a capacitor should be dipped into an ethanol solution of 25wt% rosin and then into molten solder for 2±0.5 sec. In both cases the depth of dipping is up to about 1.5 to 2.0mm from the root of lead wires. Temp. of solder: Lead Free Solder (Sn-3Ag-0.5Cu) 245±5°C H63 Eutectic Solder 235±5°C									
12	Soldering Effect (Non-Preheat)	Appearance	No marked defect	The lead wire should be immersed into the melted solder of 350±10°C up to about 1.5 to 2.0mm from the main body for 3.5±0.5 sec. Post-treatment: Capacitor should be stored for 1 to 2 hrs. at room condition* <sup>1</sup> .									
		Capacitance Change	Within ±2.5%										
		Dielectric Strength (Between Lead Wires)	Per item 4.										

\*<sup>1</sup> "room condition" Temperature: 15 to 35°C, Relative humidity: 45 to 75%, Atmospheric pressure: 86 to 106kPa

\*<sup>2</sup> "C" expresses nominal capacitance value (pF).

Continued on the following page. 

## DEF Series Specifications and Test Methods

Continued from the preceding page.

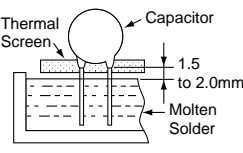
No.	Item	Specifications	Test Method																											
13	Appearance	No marked defect	First the capacitor should be stored at 120+0/-5°C for 60+0/-5 sec. Then, as in figure, the lead wires should be immersed in solder of 260+0/-5°C up to 1.5 to 2.0mm from the root of terminal for 7.5+0/-1 sec. Post-treatment: Capacitor should be stored for 1 to 2 hrs. at room condition*1. 																											
	Capacitance Change	Within ±2.5%																												
	Dielectric Strength (Between Lead Wires)	Per item 4.																												
14	Appearance	No marked defect	The capacitor should be subjected to 5 temperature cycles, then consecutively to 2 immersion cycles. <Temperature Cycle> <table border="1" data-bbox="1197 891 1555 1015"> <thead> <tr> <th>Step</th> <th>Temperature (°C)</th> <th>Time (min)</th> </tr> </thead> <tbody> <tr> <td>1</td> <td>-25±3</td> <td>30</td> </tr> <tr> <td>2</td> <td>Room Temp.</td> <td>3</td> </tr> <tr> <td>3</td> <td>105±3</td> <td>30</td> </tr> <tr> <td>4</td> <td>Room Temp.</td> <td>3</td> </tr> </tbody> </table> Cycle time: 5 cycle <Immersion Cycle> <table border="1" data-bbox="1110 1056 1603 1138"> <thead> <tr> <th>Step</th> <th>Temperature (°C)</th> <th>Time (min)</th> <th>Immersion Water</th> </tr> </thead> <tbody> <tr> <td>1</td> <td>65+5/-0</td> <td>15</td> <td>Clean water</td> </tr> <tr> <td>2</td> <td>0±3</td> <td>15</td> <td>Salt water</td> </tr> </tbody> </table> Cycle time: 2 cycle Post-treatment: Capacitor should be stored for 4 to 24 hrs. at room condition*1.	Step	Temperature (°C)	Time (min)	1	-25±3	30	2	Room Temp.	3	3	105±3	30	4	Room Temp.	3	Step	Temperature (°C)	Time (min)	Immersion Water	1	65+5/-0	15	Clean water	2	0±3	15	Salt water
	Step	Temperature (°C)		Time (min)																										
	1	-25±3		30																										
	2	Room Temp.		3																										
	3	105±3		30																										
4	Room Temp.	3																												
Step	Temperature (°C)	Time (min)	Immersion Water																											
1	65+5/-0	15	Clean water																											
2	0±3	15	Salt water																											
Capacitance Change	Within ±3%																													
Q	200+10C*2min. (10pF under) 275+5/2C*2min. (10pF min. and 30pF under) 350 min. (30pF min.)																													
I.R.	2000MΩ min.																													
Dielectric Strength (Between Lead Wires)	Per item 4.																													
15	Appearance	No marked defect	Set the capacitor for 500 +24/-0 hrs. at 40±2°C in 90 to 95% relative humidity. Post-treatment: Capacitor should be stored for 1 to 2 hrs. at room condition*1.																											
	Capacitance Change	Within ±5%																												
	Q	200+10C*2min. (10pF under) 275+5/2C*2min. (10pF min. and 30pF under) 350 min. (30pF min.)																												
	I.R.	1000MΩ min.																												
16	Appearance	No marked defect	Apply 6.3kVp-p at the frequency in Table for 1000+48/-0 hrs. at 105±2°C with a relative humidity of 50% max. (Charge/Discharge current≤50mA.) <Frequency> <table border="1" data-bbox="1110 1577 1487 1673"> <thead> <tr> <th>Capacitance (pF)</th> <th>Frequency (kHz)</th> </tr> </thead> <tbody> <tr> <td>to 10</td> <td>100</td> </tr> <tr> <td>12 to 22</td> <td>45</td> </tr> <tr> <td>27 to 47</td> <td>33</td> </tr> </tbody> </table> Post-treatment: Capacitor should be stored for 1 to 2 hrs. at room condition*1.	Capacitance (pF)	Frequency (kHz)	to 10	100	12 to 22	45	27 to 47	33																			
	Capacitance (pF)	Frequency (kHz)																												
	to 10	100																												
	12 to 22	45																												
27 to 47	33																													
Capacitance Change	Within ±3%																													
Q	200+10C*2min. (10pF under) 275+5/2C*2min. (10pF min. and 30pF under) 350 min. (30pF min.)																													
I.R.	2000MΩ min.																													

\*1 "room condition" Temperature: 15 to 35°C, Relative humidity: 45 to 75%, Atmospheric pressure: 86 to 106kPa

\*2 "C" expresses nominal capacitance value (pF).

## High Voltage Ceramic Capacitors Characteristics Data (Typical Example)

### ■ Capacitance - Temperature Characteristics

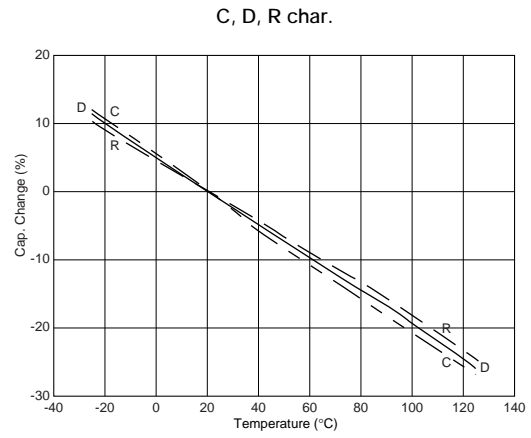
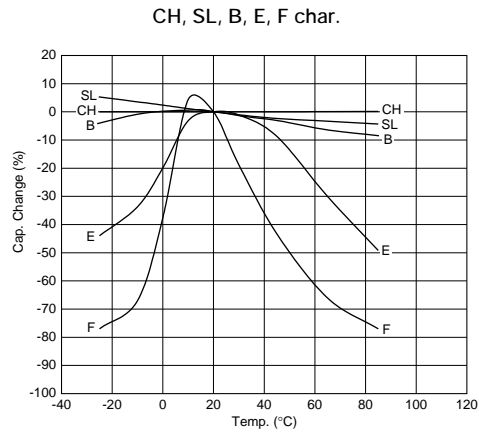

### ■ Capacitance - DC Bias Characteristics

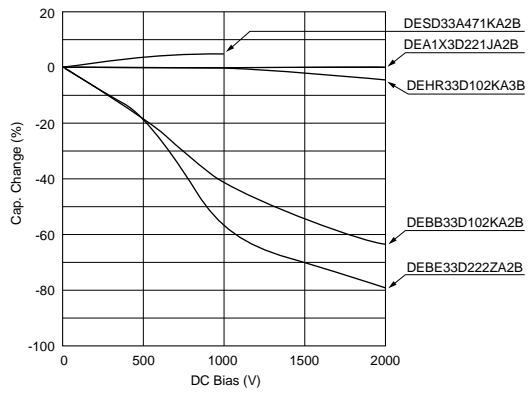

## High Voltage Ceramic Capacitors Packaging

### ■ Taping Specifications

- 15.0mm pitch / lead spacing 7.5mm taping  
Straight type  
(Lead Code: P3)

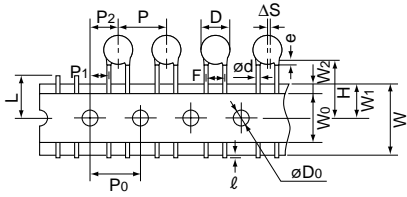

- 15.0mm pitch / lead spacing 7.5mm taping  
Vertical crimp type  
(Lead Code: N3)

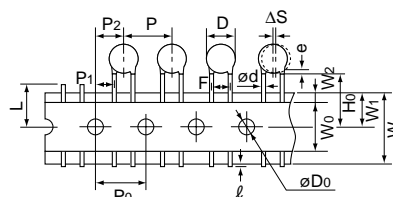

- 30.0mm pitch / lead spacing 7.5mm taping  
Vertical crimp type  
(Lead Code: N7)

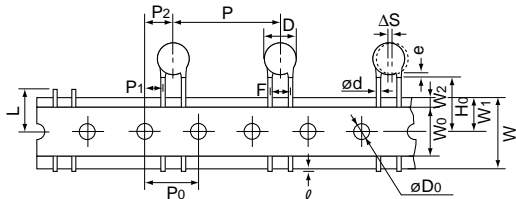

- 12.7mm pitch / lead spacing 5.0mm taping  
Straight type  
(Lead Code: P2)

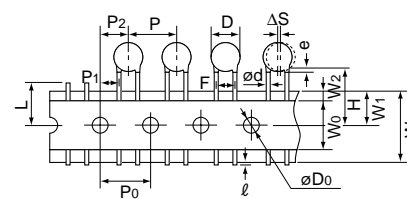

- 12.7mm pitch / lead spacing 5.0mm taping  
Vertical crimp type  
(Lead Code: N2)

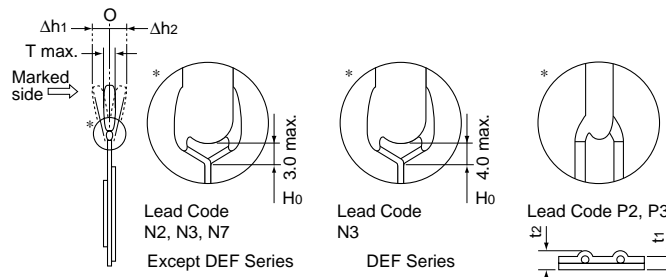
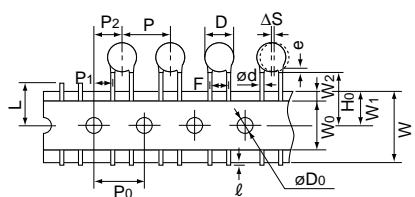

Item	Code	P3	N3	N7	P2	N2
Pitch of component	P	15.0		30.0	12.7	
Pitch of sprocket hole	P0	15.0±0.3			12.7±0.3	
Lead spacing	F	7.5±1.0			5.0 <sup>+0.8</sup> <sub>-0.2</sub>	
Length from hole center to component center	P2	7.5±1.5			6.35±1.3	
Length from hole center to lead	P1	3.75±1.0			3.85±0.7	
Body diameter	D	See the individual product specifications.				
Deviation along tape, left or right	ΔS	0±2.0			0±1.0	
Carrier tape width	W	18.0±0.5				
Position of sprocket hole	W1	9.0±0.5				
Lead distance between reference and bottom planes	H	20.0 <sup>+1.5</sup> <sub>-1.0</sub>	—		20.0 <sup>+1.5</sup> <sub>-1.0</sub>	—
	H0	—	18.0 <sup>+2.0</sup> <sub>-0</sub>		—	18.0 <sup>+2.0</sup> <sub>-0</sub>
Protrusion length	ℓ	+0.5 to -1.0				
Diameter of sprocket hole	φD0	4.0±0.1				
Lead diameter	φd	0.6±0.05				
Total tape thickness	t1	0.6±0.3				
Total thickness, tape and lead wire	t2	1.5 max.				
Body thickness	T	See the individual product specifications.				
Portion to cut in case of defect	L	11.0 <sup>+0</sup> <sub>-1.0</sub>				
Hold down tape width	W0	11.5 min.				
Hold down tape position	W2	1.5±1.5				
Coating extension on lead	e	3.0 max. (Vertical crimp type: Up to the end of crimp)				
Deviation across tape, front	Δh1	2.0 max.			1.0 max.	
Deviation across tape, rear	Δh2					



(in : mm)

Continued on the following page. ↗

## High Voltage Ceramic Capacitors Packaging

☒ Continued from the preceding page.

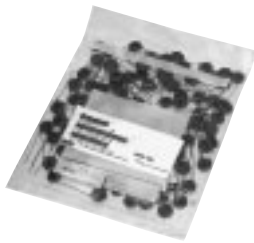
### ■ Packaging Styles

Bulk	Taping
Polyethylene Bag 	Ammo Pack 

### ■ Minimum Quantity (Order in Sets Only)

[Bulk] 1,000 pcs.

[Taping]

1,500 pcs. (Lead Code: P2, N2)

1,000 pcs. (Lead Code: P3, N3\*)

500 pcs. (Lead Code: N7)

\* 900 pcs. for 2kV, 3.15kV and DEF Series

### ■ Minimum Order Quantity

[Bulk] 3,000 pcs.

[Taping]

3,000 pcs. (Lead Code: P2, N2)

3,000 pcs. (Lead Code: P3, N3\*)

2,000 pcs. (Lead Code: N7)

\* 2,700 pcs. for 2kV, 3.15kV and DEF Series

"Minimum Quantity" means the numbers of units of each delivery or order. The quantity should be an integral multiple of the "minimum quantity". (Please note that the actual delivery quantity in a package may change sometimes.)

## High Voltage Ceramic Capacitors ⚠Caution

### ■ ⚠Caution (Rating)

<DES/DEH/DEA/DEB/DEC Series>

#### 1. Operating Voltage

When DC-rated capacitors are to be used in AC or ripple current circuits, be sure to maintain the  $V_{p-p}$  value of the applied voltage or the  $V_{o-p}$  which contains DC bias within the rated voltage range.

When the voltage is applied to the circuit, starting or stopping may generate irregular voltage for a transit period because of resonance or switching. Be sure to use a capacitor with a rated voltage range that includes these irregular voltages.

When using the low-dissipation DEA (SL Char.) /DEC (SL Char.) /DEH (C, R Char.) /DES (D Char.) series in a high-frequency and high-voltage circuit, be sure to read the instructions in item 4.

When DC-rated capacitors are to be used in input circuits from commercial power source (AC filter), be sure to use Safety Certified Capacitors because various regulations on withstand voltage or impulse withstand established for each equipment should be taken into considerations.

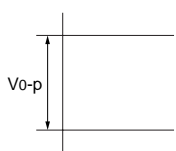
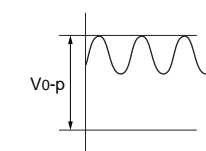
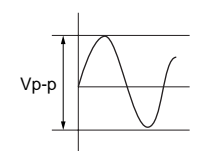
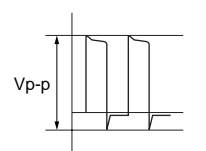
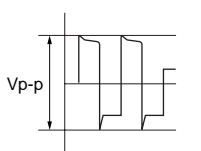
Voltage	DC Voltage	DC+AC Voltage	AC Voltage	Pulse Voltage (1)	Pulse Voltage (2)
Positional Measurement					

#### 2. Operating Temperature and Self-generated Heat

Keep the surface temperature of a capacitor below the upper limit of its rated operating temperature range. Be sure to take into account the heat generated by the capacitor itself. When the capacitor is used in a high-frequency current, pulse current or similar current, it may self-generate heat due to dielectric loss. The frequency of the applied sine wave voltage should be less than 300kHz. The applied voltage load (\*) should be such that the capacitor's self-generated heat is within 20°C in an atmosphere temperature of 25°C. When measuring, use a thermocouple of small thermal capacity-K of  $\phi 0.1$ mm in conditions where the capacitor is not affected by radiant heat from other components or surrounding ambient fluctuations.

Excessive heat may lead to deterioration of the capacitor's characteristics and reliability.

(Never attempt to perform measurement with the cooling fan running. Otherwise, accurate measurement cannot be ensured.)

\*Before using the low-dissipation DEA/DEC (SL Char.) /DEH/DES series, be sure to read the instructions in item 4.

#### 3. Fail-Safe

When capacitor is broken, failure may result in a short circuit. Be sure to provide an appropriate fail-safe function like a fuse on your product if failure would follow an electric shock, fire or fume.

Continued on the following page. 

## High Voltage Ceramic Capacitors ⚠Caution

↳ Continued from the preceding page.

### 4. Load Reduction and Self-generated Heat During

#### Application of High-frequency and High-voltage

Due to the low self-heating characteristics of low-dissipation capacitors, the allowable electric power of these capacitors is generally much higher than that of B characteristic capacitors. However, in case the self-heating temperature is 20°C under a high-frequency voltage whose peak-to-peak value equals the capacitor's rated voltage, the capacitor's power consumption may exceed its allowable electric power.

Therefore, when using the DEA/DEC (SL Char.) /DEH /DES series in a high-frequency and high-voltage circuit with a frequency of 1kHz or higher, make sure that the Vp-p values including the DC bias, do not exceed the applied voltage value specified in Table 1. Also make sure that the self-heating temperature (the difference between the capacitor's surface temperature and the capacitor's ambient temperature ) at an ambient temperature of 25°C does not exceed the value specified in Table 1.

As shown in Fig. 2, the self-heating temperature depends on the ambient temperature. Therefore, if you are not able to set the ambient temperature to approximately 25°C, please contact our sales representatives or product engineers.

We are offering free software, The Capacitor Selection Tool: by Voltage Form\* which will assist you in selecting a suitable capacitor.

The software can be downloaded from Murata's Internet Web site.

([http://www.murata.com/designlib/mmcsv\\_e.html](http://www.murata.com/designlib/mmcsv_e.html))

By inputting capacitance values and applied voltage waveform of the specific capacitor series, this software will calculate the capacitor's power consumption and list suitable capacitors.

When the result of this software is different from the measurement result of the self-heating temperature on your side, please contact our sales representatives or product engineers.

\* Subject series are below.

- DEA/DEC (SL char.) /DEH/DES/DEF Series

**FAILURE TO FOLLOW THE ABOVE CAUTIONS (ITEMS 1 TO 4) MAY RESULT, WORST CASE, IN A SHORT CIRCUIT AND CAUSE FUMING OR PARTIAL DISPERSION WHEN THE PRODUCT IS USED.**

<Table 1> Allowable Conditions at High-frequency

Series	Temp. Char.	DC Rated Voltage	Allowable Conditions at High-frequency *3		Capacitor's Ambient Temp. *2
			Applied Voltage (Max.)	Self-heating Temp. (25°C Ambient Temp.) *1	
DEH	R	250V	250Vp-p	10°C Max.	-25 to +85°C
	C	500V	500Vp-p	20°C Max.	
	R	1kV	800Vp-p	20°C Max.	
			1000Vp-p	5°C Max.	
		2kV	1400Vp-p	20°C Max.	
			2000Vp-p	5°C Max.	
			1600Vp-p	20°C Max.	
3.15kV	3150Vp-p	5°C Max.			
DEA	SL	1kV	1000Vp-p	5°C Max.	
		2kV	2000Vp-p		
		3.15kV	3150Vp-p		
DEC	SL	6.3kV	6300Vp-p	5°C Max.	
DES	D	500V	500Vp-p	15°C Max.	
		1kV	800Vp-p		
		1000Vp-p	5°C Max.		

\*1 Fig. 1 shows the relationship between the applied voltage and the allowable self-heating temperature regarding 1 to 3.15kV rated voltage of the DEH series R characteristic and 1kV rated voltage of the DES series D characteristic.

\*2 When the ambient temperature is 85 to 125°C, the applied voltage needs to be further reduced. If the DEA/DEH/DES series needs to be used at an ambient temperature of 85 to 125°C, please contact our sales representatives or product engineers.

\*3 Fig. 3 shows reference data on the allowable voltage - frequency characteristics for a sine wave voltage.

<Fig. 1> Relationship Between Applied Voltage and Self-heating Temperature (Allowable Self-heating Temp. at 25°C Ambient Temp.)

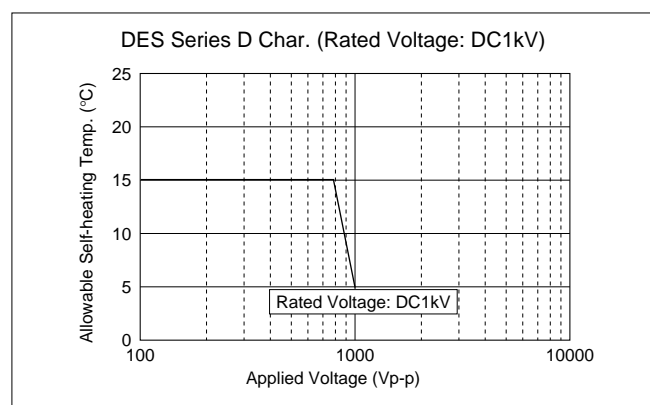
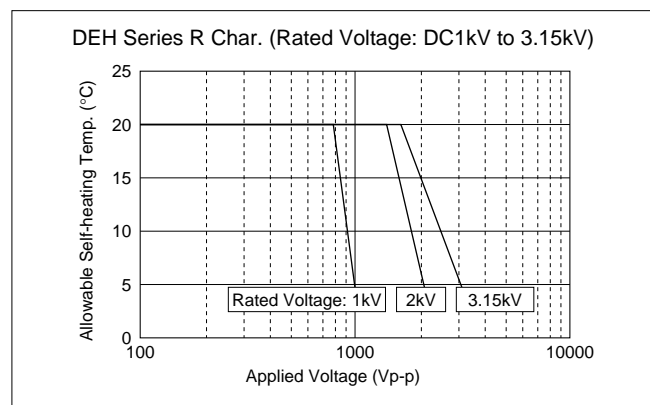

Continued on the following page. ↗

## High Voltage Ceramic Capacitors ⚠Caution

↳ Continued from the preceding page.

<Fig. 2> Dependence of Self-heating Temperature on Ambient Temperature

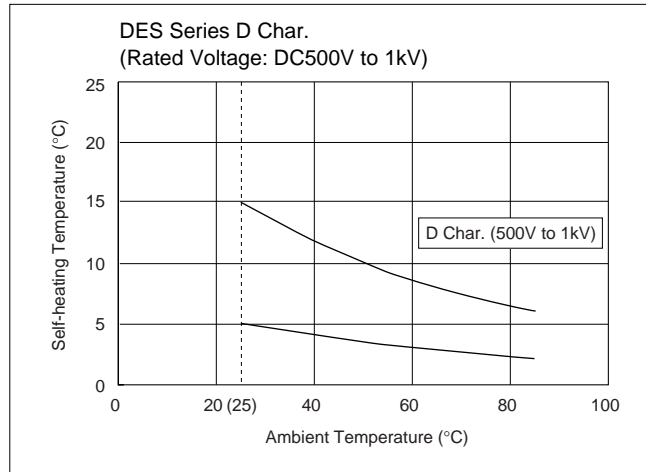
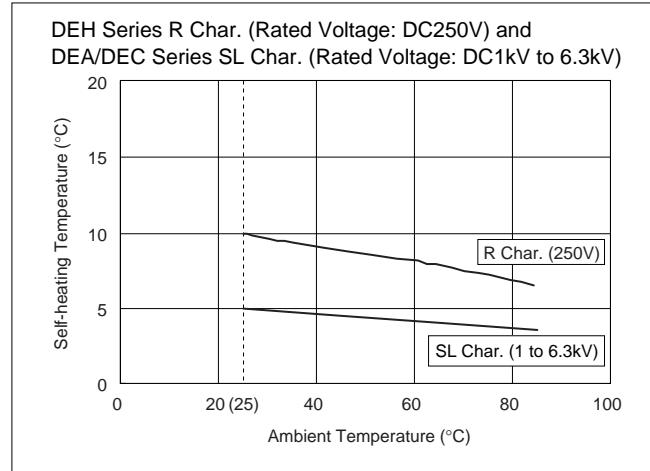
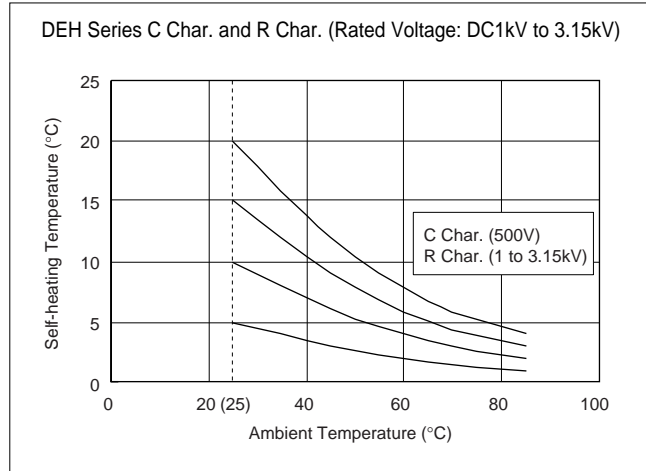

Continued on the following page. ↗

## High Voltage Ceramic Capacitors ⚠Caution

↳ Continued from the preceding page.

<Fig. 3> Allowable Voltage (Sine Wave Voltage) - Frequency Characteristics (At Ambient Temperature of 85°C or less)

Because of the influence of harmonics, when the applied voltage is a rectangular wave or pulse wave voltage (instead of a sine wave voltage), the heat generated by the capacitor is higher than the value obtained by application of the sine wave with the same fundamental frequency.

Roughly calculated for reference, the allowable voltage for a rectangular wave or pulse wave corresponds approximately

to the allowable voltage for a sine wave whose fundamental frequency is twice as large as that of the rectangular wave or pulse wave. This allowable voltage, however, varies depending on the voltage and current waveforms.

Therefore, you are requested to make sure that the self-heating temperature is not higher than the value specified in Table 1.

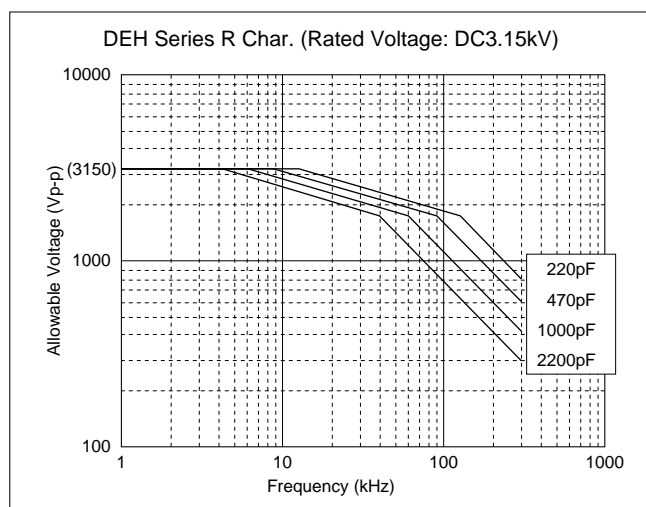
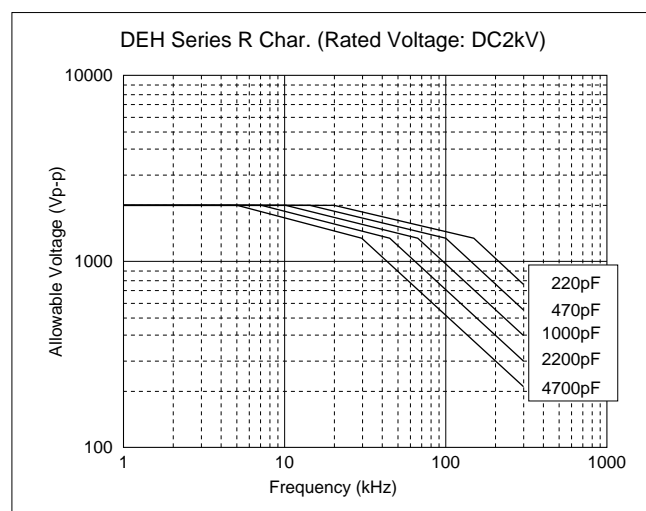
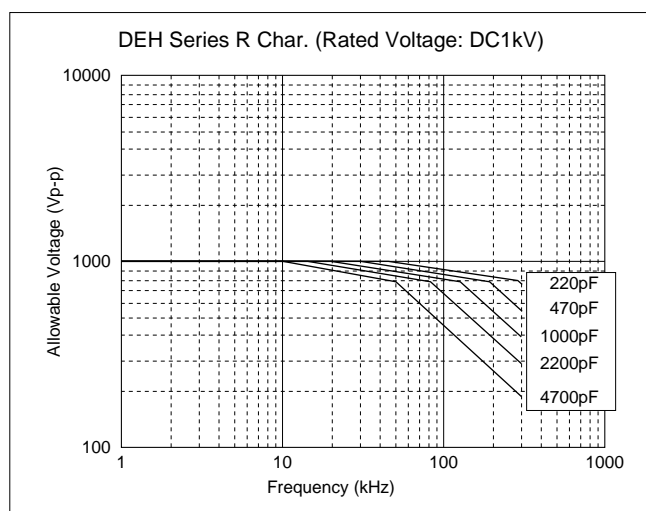
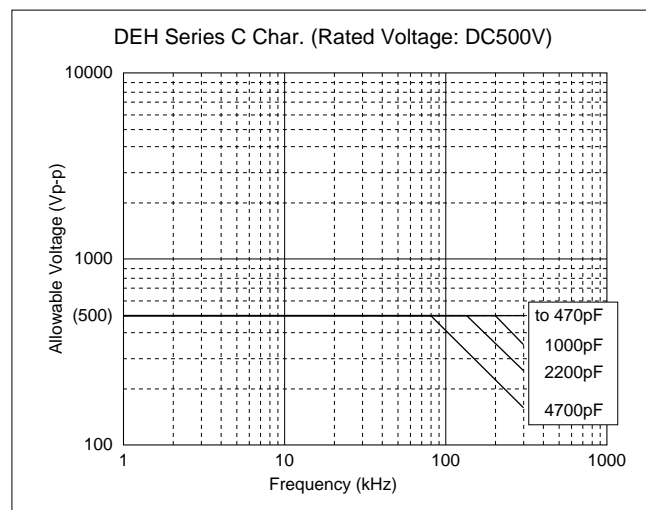
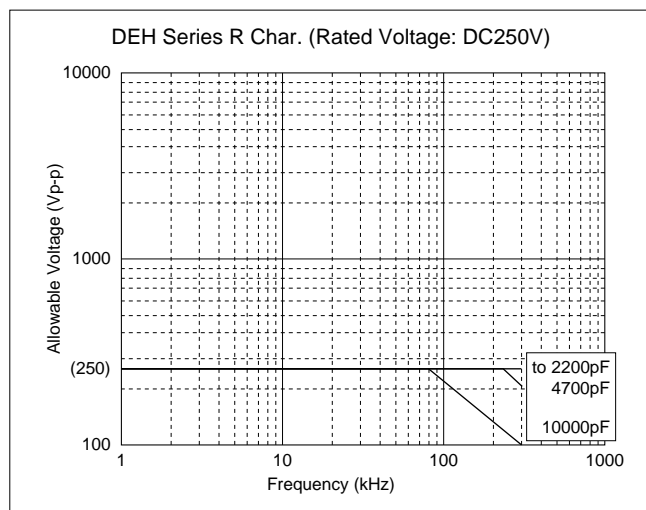

Continued on the following page. ↗

## High Voltage Ceramic Capacitors ⚠Caution

↳ Continued from the preceding page.

<Fig. 3 (continued)> Allowable Voltage (Sine Wave Voltage) - Frequency Characteristics (At Ambient Temperature of 85°C or less)

Because of the influence of harmonics, when the applied voltage is a rectangular wave or pulse wave voltage (instead of a sine wave voltage), the heat generated by the capacitor is higher than the value obtained by application of the sine wave with the same fundamental frequency.

Roughly calculated for reference, the allowable voltage for a rectangular wave or pulse wave corresponds

approximately to the allowable voltage for a sine wave whose fundamental frequency is twice as large as that of the rectangular wave or pulse wave.

This allowable voltage, however, varies depending on the voltage and current waveforms.

Therefore, you are requested to make sure that the self-heating temperature is not higher than the value specified in Table 1.

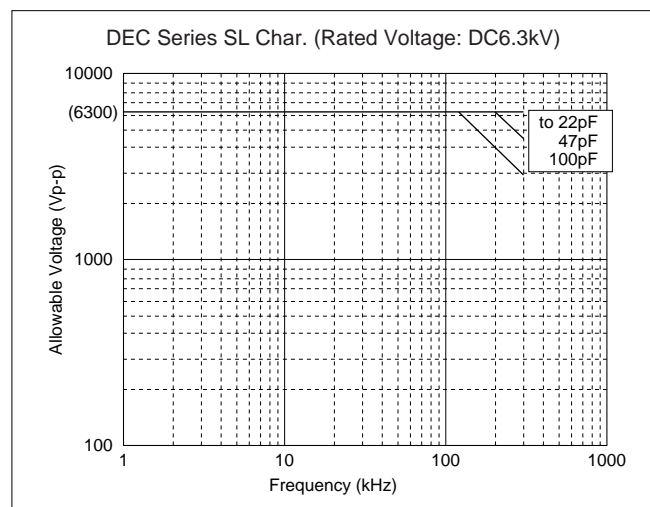
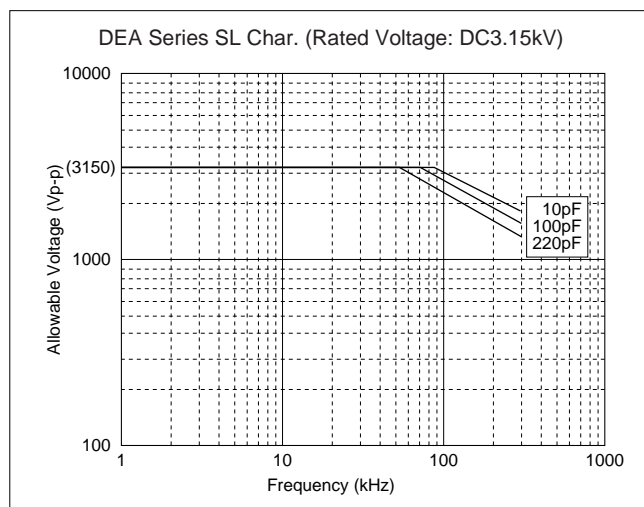
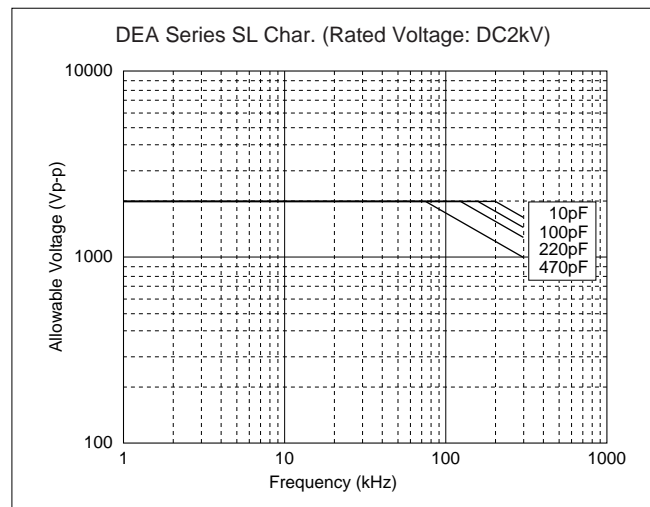
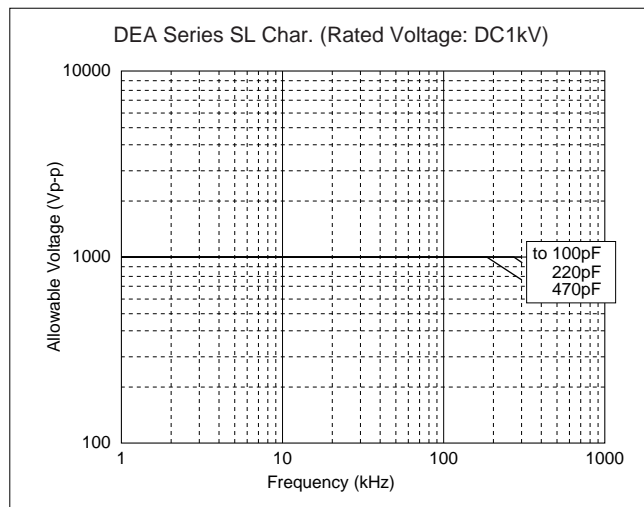

Continued on the following page. ↗

## High Voltage Ceramic Capacitors ⚠Caution

↳ Continued from the preceding page.

<Fig. 3 (continued)> Allowable Voltage (Sine Wave Voltage) - Frequency Characteristics (At Ambient Temperature of 85°C or less)

Because of the influence of harmonics, when the applied voltage is a rectangular wave or pulse wave voltage (instead of a sine wave voltage), the heat generated by the capacitor is higher than the value obtained by application of the sine wave with the same fundamental frequency.

Roughly calculated for reference, the allowable voltage for a rectangular wave or pulse wave corresponds

approximately to the allowable voltage for a sine wave whose fundamental frequency is twice as large as that of the rectangular wave or pulse wave.

This allowable voltage, however, varies depending on the voltage and current waveforms.

Therefore, you are requested to make sure that the self-heating temperature is not higher than the value specified in Table 1.

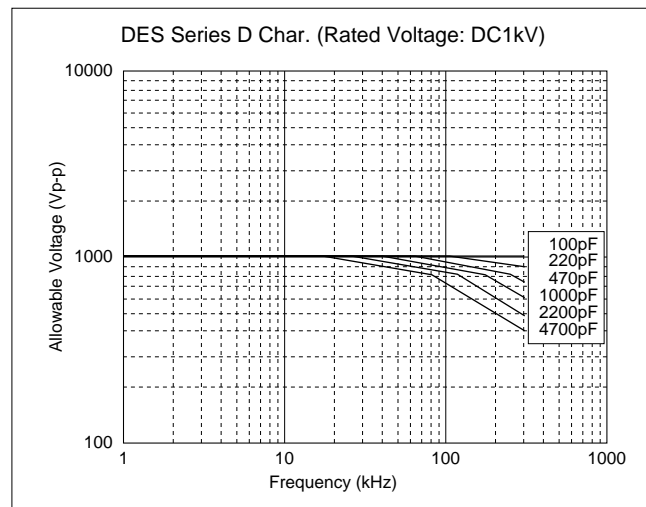
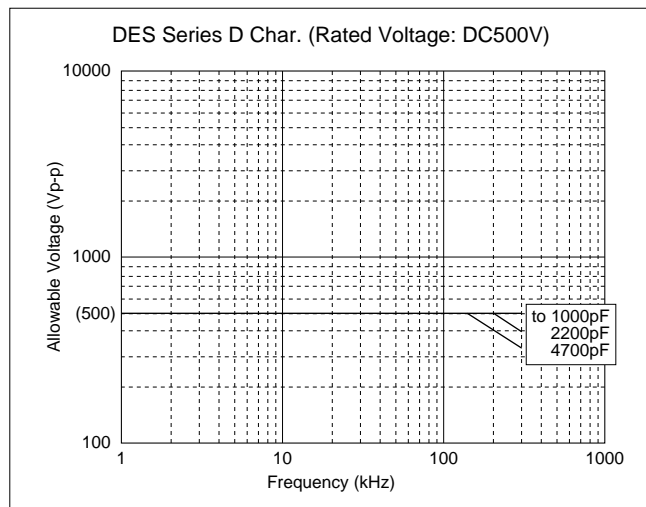

Continued on the following page. ↗

## High Voltage Ceramic Capacitors ⚠Caution

↳ Continued from the preceding page.

### <DEF Series>

#### 1. Operating Voltage

The frequency of the applied sine wave voltage should be less than 100kHz. The applied voltage should be less than the value shown in figure below. In case of non-sine wave which includes a harmonic frequency, please contact our sales representatives or product engineers.

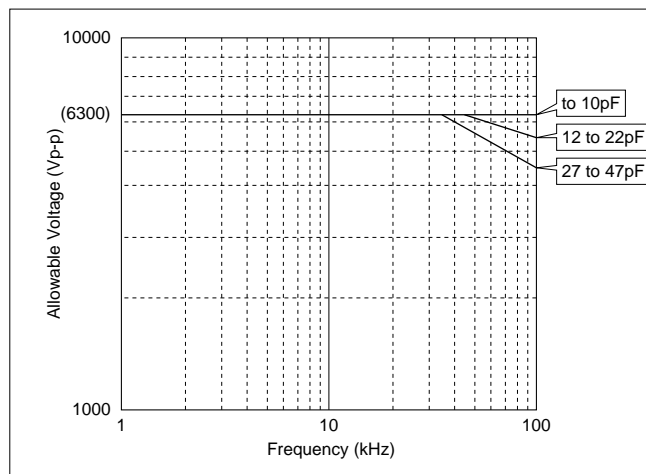

The temperature of the surface of capacitor: below the upper limit of its rated operating temperature range (including self-heating.)

The capacitor can be applied maximum 6.3kVp-p at 100kHz when lamp turn on.

Voltage	AC Voltage
Positional Measurement	

#### 2. Operating Temperature and Self-generated Heat

Keep the surface temperature of a capacitor below the upper limit of its rated operating temperature range. Be sure to take into account the heat generated by the capacitor itself. When the capacitor is used in a high-frequency current, pulse current or similar current, it may self-generate heat due to dielectric loss. Excessive heat may lead to deterioration of the capacitor's characteristics and reliability. (Never attempt to perform measurement with the cooling fan running. Otherwise, accurate measurement cannot be ensured.)

#### 3. Fail-Safe

When capacitor is broken, failure may result in a short circuit. Be sure to provide an appropriate fail-safe function like a fuse on your product if failure could result in an electric shock, fire or fume.

## High Voltage Ceramic Capacitors ⚠Caution

### ■ ⚠Caution (Storage and Operating Condition)

#### Operating and Storage Environment

The insulating coating of capacitors does not form a perfect seal; therefore, do not use or store capacitors in a corrosive atmosphere, especially where chloride gas, sulfide gas, acid, alkali, salt or the like are present. And avoid exposure to moisture. Before cleaning, bonding or molding this product, verify that these processes do not affect product quality by testing the performance of a cleaned, bonded or molded product in the intended

equipment. Store the capacitors where the temperature and relative humidity do not exceed -10 to 40 degrees centigrade and 15 to 85%.  
Use capacitors within 6 months after delivery.

FAILURE TO FOLLOW THE ABOVE CAUTIONS MAY RESULT, WORST CASE, IN A SHORT CIRCUIT AND CAUSE FUMING OR PARTIAL DISPERSION WHEN THE PRODUCT IS USED.

### ■ ⚠Caution (Soldering and Mounting)

#### 1. Vibration and Impact

Do not expose a capacitor or its leads to excessive shock or vibration during use.

#### 2. Soldering

When soldering this product to a PCB/PWB, do not exceed the solder heat resistance specification of the capacitor. Subjecting this product to excessive heating could melt the internal junction solder and may result in thermal shocks that can crack the ceramic element.

When soldering capacitor with a soldering iron, it should be performed in following conditions.

Temperature of iron-tip: 400 degrees C. max.

Soldering iron wattage: 50W max.

Soldering time: 3.5 sec. max.

#### 3. Bonding, Resin Molding and Coating

Before bonding, molding or coating this product, verify that these processes do not affect the quality of capacitor by testing the performance

of the bonded, molded or coated product in the intended equipment.

In case the amount of applications, dryness/hardening conditions of adhesives and molding resins containing organic solvents (ethyl acetate, methyl ethyl ketone, toluene, etc.) are unsuitable, the outer coating resin of a capacitor is damaged by the organic solvents and it may result, worst case, in a short circuit.

The variation in thickness of adhesive, molding resin or coating may cause outer coating resin cracking and/or ceramic element cracking of a capacitor in a temperature cycling.

FAILURE TO FOLLOW THE ABOVE CAUTIONS MAY RESULT, WORST CASE, IN A SHORT CIRCUIT AND CAUSE FUMING OR PARTIAL DISPERSION WHEN THE PRODUCT IS USED.

### ■ ⚠Caution (Handling)

#### Vibration and Impact

Do not expose a capacitor or its leads to excessive shock or vibration during use.

FAILURE TO FOLLOW THE ABOVE CAUTIONS MAY RESULT, WORST CASE, IN A SHORT CIRCUIT AND CAUSE FUMING OR PARTIAL DISPERSION WHEN THE PRODUCT IS USED.

## High Voltage Ceramic Capacitors Notice

### ■ Notice (Soldering and Mounting)

#### Cleaning (ultrasonic cleaning)

To perform ultrasonic cleaning, observe the following conditions.

Rinse bath capacity: Output of 20 watts per liter or less.

Rinsing time: 5 min. maximum.

Do not vibrate the PCB/PWB directly.

Excessive ultrasonic cleaning may lead to fatigue destruction of the lead wires.

### ■ Notice (Rating)

#### Capacitance Change of Capacitor

##### 1. DEA/DEC/DEF Series (Temp. Char. CH, SL)

Capacitance might change a little depending on the surrounding temperature or an applied voltage.

Please contact us if you intend to use this product in a strict time constant circuit.

##### 2. DEB/DEC Series (Temp. Char. B, E, F)

Capacitors have an aging characteristic, whereby the capacitor continually decreases its capacitance slightly if the capacitor is left on for a long time. Moreover, capacitance might

change greatly depending on the surrounding temperature or an applied voltage. So, it is not likely to be suitable for use in a time constant circuit.

Please contact us if you need detailed information.

##### 3. DEH/DES Series

Capacitance might change greatly depending on the surrounding temperature or an applied voltage.

So, it is not likely to be suitable for use in a time constant circuit. Please contact us if you need detailed information.

## Safety Certified Ceramic Capacitors/High Voltage Ceramic Capacitors ISO9000 Certifications

Manufacturing plants which produce the products in this catalog have obtained the ISO9000 quality system certificate.

Plant	Applied Standard
Izumo Murata Manufacturing Co., Ltd.	ISO9001
Murata Electronics (Thailand), Ltd.	ISO9001
Taiwan Murata Electronics Co., Ltd.	ISO9001

△Note • This PDF catalog is downloaded from the website of Murata Manufacturing co., Ltd. Therefore, it's specifications are subject to change or our products in it may be discontinued without advance notice. Please check with our sales representatives or product engineers before ordering.  
• This PDF catalog has only typical specifications because there is no space for detailed specifications. Therefore, please approve our product specifications or transact the approval sheet for product specifications before ordering.

C85E.pdf  
08.10.29

**△Note:**

1. Export Control

<For customers outside Japan>

No muRata products should be used or sold, through any channels, for use in the design, development, production, utilization, maintenance or operation of, or otherwise contribution to (1) any weapons (Weapons of Mass Destruction [nuclear, chemical or biological weapons or missiles] or conventional weapons) or (2) goods or systems specially designed or intended for military end-use or utilization by military end-users.

<For customers in Japan>

For products which are controlled items subject to the "Foreign Exchange and Foreign Trade Law" of Japan, the export license specified by the law is required for export.

2. Please contact our sales representatives or product engineers before using the products in this catalog for the applications listed below, which require especially high reliability for the prevention of defects which might directly damage a third party's life, body or property, or when one of our products is intended for use in applications other than those specified in this catalog.

- |                             |  |
|-----------------------------|--|
| ① Aircraft equipment        | ② Aerospace equipment  |
| ③ Undersea equipment        | ④ Power plant equipment  |
| ⑤ Medical equipment         | ⑥ Transportation equipment (vehicles, trains, ships, etc.)   |
| ⑦ Traffic signal equipment  | ⑧ Disaster prevention / crime prevention equipment   |
| ⑨ Data-processing equipment | ⑩ Application of similar complexity and/or reliability requirements to the applications listed above |

3. Product specifications in this catalog are as of September 2008. They are subject to change or our products in it may be discontinued without advance notice. Please check with our sales representatives or product engineers before ordering. If there are any questions, please contact our sales representatives or product engineers.

4. Please read rating and △ CAUTION (for storage, operating, rating, soldering, mounting and handling) in this catalog to prevent smoking and/or burning, etc.

5. This catalog has only typical specifications because there is no space for detailed specifications. Therefore, please approve our product specifications or transact the approval sheet for product specifications before ordering.

6. Please note that unless otherwise specified, we shall assume no responsibility whatsoever for any conflict or dispute that may occur in connection with the effect of our and/or a third party's intellectual property rights and other related rights in consideration of your use of our products and/or information described or contained in our catalogs. In this connection, no representation shall be made to the effect that any third parties are authorized to use the rights mentioned above under licenses without our consent.

7. No ozone depleting substances (ODS) under the Montreal Protocol are used in our manufacturing process.

 **Murata Manufacturing Co., Ltd.**

<http://www.murata.com/>

**Head Office**

1-10-1, Higashi Kotari, Nagaokakyo-shi, Kyoto 617-8555, Japan  
Phone: 81-75-951-9111

**International Division**

3-29-12, Shibuya, Shibuya-ku, Tokyo 150-0002, Japan  
Phone: 81-3-5469-6123 Fax: 81-3-5469-6155 E-mail: [intl@murata.co.jp](mailto:intl@murata.co.jp)

## Looking for pricing, stock, or lifecycle information?

Click below to explore more details on WIN SOURCE:

- [View DEBB33F221KCDB on WIN SOURCE](#)
- [Murata Electronics North America Information](#)

## Optimize Your Supply Chain with WIN SOURCE Solutions

- ✓ Global Sourcing Solution
- ✓ Obsolete Management
- ✓ Cost Control Management
- ✓ Shortage Management
- ✓ Alternative Solution
- ✓ Excess Inventory Management