



**THE DATASHEET OF
IMZA120R020M1HXKSA1**



CoolSiC™ 1200 V SiC Trench MOSFET : Silicon Carbide MOSFET with .XT interconnection technology

Features

- $V_{DSS} = 1200\text{ V}$ at $T_{vj} = 25^\circ\text{C}$
- $I_{DC} = 98\text{ A}$ at $T_c = 25^\circ\text{C}$
- $R_{DS(on)} = 19\text{ m}\Omega$ at $V_{GS} = 18\text{ V}$, $T_{vj} = 25^\circ\text{C}$
- Very low switching losses
- Short circuit withstand time $3\text{ }\mu\text{s}$
- Benchmark gate threshold voltage, $V_{GS(th)} = 4.2\text{ V}$
- Robust against parasitic turn on, 0 V turn-off gate voltage can be applied
- Robust body diode for hard commutation
- .XT interconnection technology for best-in-class thermal performance

Potential applications

- General purpose drives (GPD)
- EV-Charging
- Online UPS/Industrial UPS
- String inverter
- Solar power optimizer

Product validation

- Qualified for industrial applications according to the relevant tests of JEDEC47/20/22

Description

- 1 – drain
- 2 – source
- 3 – Kelvin sense contact
- 4 – gate

Note: the source and sense pins are not exchangeable, their exchange might lead to malfunction (only for 4pin, TO263-7L)



- Halogen-free
- Green
- Lead-free
- RoHS

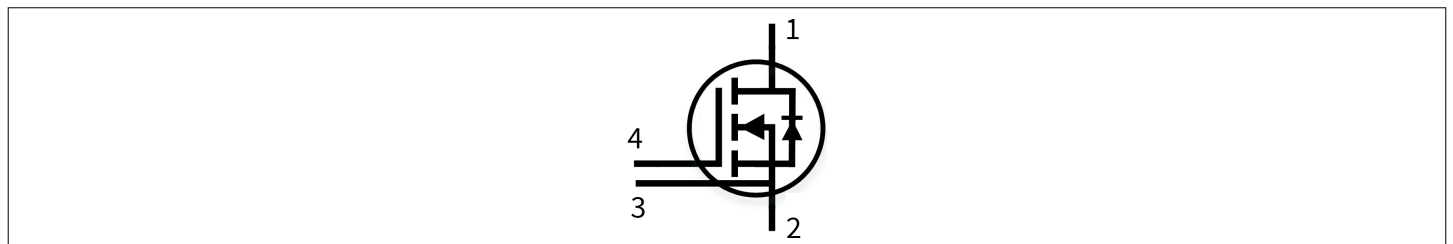

Type	Package	Marking
IMZA120R020M1H	PG-TO247-4-STD-NT3.7	12M1H020

Table of contents

	Description	1
	Features	1
	Potential applications	1
	Product validation	1
	Table of contents	2
1	Package	3
2	MOSFET	3
3	Body diode (MOSFET)	6
4	Characteristics diagrams	7
5	Package outlines	13
6	Testing conditions	14
	Revision history	15
	Disclaimer	16

1 Package

Table 1 Characteristic values

Parameter	Symbol	Note or test condition	Values			Unit
			Min.	Typ.	Max.	
Storage temperature	T_{stg}		-55		150	°C
Soldering temperature	T_{sold}	wave soldering 1.6 mm (0.063 in.) from case for 10 s			260	°C
Mounting torque	M	M3 screw, Maximum of mounting processes: 3			0.6	Nm
Thermal resistance, junction-ambient	$R_{th(j-a)}$				62	K/W
MOSFET/body diode thermal resistance, junction-case	$R_{th(j-c)}$			0.31	0.40	K/W

2 MOSFET

Table 2 Maximum rated values

Parameter	Symbol	Note or test condition	Values	Unit	
Drain-source voltage	V_{DSS}	$T_{vj} \geq 25 \text{ °C}$	1200	V	
Continuous DC drain current for $R_{th(j-c,max)}$, limited by $T_{vj(max)}$	I_{DDC}	$V_{GS} = 18 \text{ V}$	$T_c = 25 \text{ °C}$	98	A
			$T_c = 100 \text{ °C}$	71	
Peak drain current, t_p limited by $T_{vj(max)}$	I_{DM}	$V_{GS} = 18 \text{ V}$	213	A	
Gate-source voltage, max. transient voltage ¹⁾	V_{GS}	$t_p \leq 0.5 \text{ }\mu\text{s}$, $D < 0.01$	-10/23	V	
Gate-source voltage, max. static voltage	V_{GS}		-7/20	V	
Avalanche energy, single pulse	E_{AS}	$I_D = 40.1 \text{ A}$, $V_{DD} = 50 \text{ V}$, $L = 0.9 \text{ mH}$	721	mJ	
Avalanche energy, repetitive	E_{AR}	$I_D = 40.1 \text{ A}$, $V_{DD} = 50 \text{ V}$, $L = 4.5 \text{ }\mu\text{H}$	3.58	mJ	
Short-circuit withstand time	t_{SC}	$V_{DD} \leq 800 \text{ V}$, $V_{DS,peak} < 1200 \text{ V}$, $V_{GS(on)} = 15 \text{ V}$, $T_{vj(start)} = 25 \text{ °C}$	3	μs	
Power dissipation, limited by $T_{vj(max)}$	P_{tot}		$T_c = 25 \text{ °C}$	375	W
			$T_c = 100 \text{ °C}$	188	

1) Important note: The selection of positive and negative gate-source voltages impacts the long-term behavior of the device. The design guidelines described in Application Note AN2018-09 must be considered to ensure sound operation of the device over the planned lifetime.

Table 3 Recommended values

Parameter	Symbol	Note or test condition	Values	Unit
Recommended turn-on gate voltage	$V_{GS(on)}$		15...18	V
Recommended turn-off gate voltage	$V_{GS(off)}$		-5...0	V

Table 4 Characteristic values

Parameter	Symbol	Note or test condition	Values			Unit	
			Min.	Typ.	Max.		
Drain-source on-state resistance	$R_{DS(on)}$	$I_D = 41\text{ A}$	$T_{vj} = 25\text{ °C}$, $V_{GS(on)} = 18\text{ V}$		19	26.9	mΩ
			$T_{vj} = 100\text{ °C}$, $V_{GS(on)} = 18\text{ V}$		25		
			$T_{vj} = 175\text{ °C}$, $V_{GS(on)} = 18\text{ V}$		36		
			$T_{vj} = 25\text{ °C}$, $V_{GS(on)} = 15\text{ V}$		23.7	30	
Gate-source threshold voltage	$V_{GS(th)}$	$I_D = 17.6\text{ mA}$, $V_{DS} = V_{GS}$ (tested after 1 ms pulse at $V_{GS} = 20\text{ V}$)	$T_{vj} = 25\text{ °C}$	3.5	4.2	5.2	V
			$T_{vj} = 175\text{ °C}$		3.6		
Zero gate-voltage drain current	I_{DSS}	$V_{DS} = 1200\text{ V}$, $V_{GS} = 0\text{ V}$	$T_{vj} = 25\text{ °C}$			320	μA
			$T_{vj} = 175\text{ °C}$		5.4		
Gate leakage current	I_{GSS}	$V_{DS} = 0\text{ V}$	$V_{GS} = 23\text{ V}$			100	nA
			$V_{GS} = -10\text{ V}$			-100	
Forward transconductance	g_{fs}	$I_D = 41\text{ A}$, $V_{DS} = 20\text{ V}$		27.4		S	
Internal gate resistance	$R_{G,int}$	$f = 1\text{ MHz}$, $V_{AC} = 25\text{ mV}$		1.8		Ω	
Input capacitance	C_{iss}	$V_{DD} = 800\text{ V}$, $V_{GS} = 0\text{ V}$, $f = 100\text{ kHz}$, $V_{AC} = 25\text{ mV}$		3460		pF	
Output capacitance	C_{oss}	$V_{DD} = 800\text{ V}$, $V_{GS} = 0\text{ V}$, $f = 100\text{ kHz}$, $V_{AC} = 25\text{ mV}$		159		pF	
Reverse transfer capacitance	C_{rss}	$V_{DD} = 800\text{ V}$, $V_{GS} = 0\text{ V}$, $f = 100\text{ kHz}$, $V_{AC} = 25\text{ mV}$		23		pF	
C_{oss} stored energy	E_{oss}	$V_{DD} = 800\text{ V}$, $V_{GS} = 0\text{ V}$, $f = 100\text{ kHz}$, $V_{AC} = 25\text{ mV}$		65		μJ	
Total gate charge	Q_G	$V_{DD} = 800\text{ V}$, $I_D = 41\text{ A}$, $V_{GS} = -2/18\text{ V}$, turn-on pulse		109		nC	
Plateau gate charge	$Q_{GS(pl)}$	$V_{DD} = 800\text{ V}$, $I_D = 41\text{ A}$, $V_{GS} = -2/18\text{ V}$, turn-on pulse		27.1		nC	
Gate-to-drain charge	Q_{GD}	$V_{DD} = 800\text{ V}$, $I_D = 41\text{ A}$, $V_{GS} = -2/18\text{ V}$, turn-on pulse		21.8		nC	

(table continues...)

Table 4 (continued) Characteristic values

Parameter	Symbol	Note or test condition	Values			Unit
			Min.	Typ.	Max.	
Turn-on delay time	$t_{d(on)}$	$V_{DD} = 800\text{ V}, I_D = 41\text{ A},$ $V_{GS} = 0/18\text{ V},$ $R_{GS(on)} = 1\ \Omega,$ $R_{GS(off)} = 1\ \Omega, L_\sigma = 15\text{ nH},$ diode: body diode at $V_{GS} = 0\text{ V}$	$T_{vj} = 25\text{ }^\circ\text{C}$		36	ns
			$T_{vj} = 175\text{ }^\circ\text{C}$		34	
Rise time	t_r	$V_{DD} = 800\text{ V}, I_D = 41\text{ A},$ $V_{GS} = 0/18\text{ V},$ $R_{GS(on)} = 1\ \Omega,$ $R_{GS(off)} = 1\ \Omega, L_\sigma = 15\text{ nH},$ diode: body diode at $V_{GS} = 0\text{ V}$	$T_{vj} = 25\text{ }^\circ\text{C}$		13.7	ns
			$T_{vj} = 175\text{ }^\circ\text{C}$		15.5	
Turn-off delay time	$t_{d(off)}$	$V_{DD} = 800\text{ V}, I_D = 41\text{ A},$ $V_{GS} = 0/18\text{ V},$ $R_{GS(on)} = 1\ \Omega,$ $R_{GS(off)} = 1\ \Omega, L_\sigma = 15\text{ nH},$ diode: body diode at $V_{GS} = 0\text{ V}$	$T_{vj} = 25\text{ }^\circ\text{C}$		43.8	ns
			$T_{vj} = 175\text{ }^\circ\text{C}$		46	
Fall time	t_f	$V_{DD} = 800\text{ V}, I_D = 41\text{ A},$ $V_{GS} = 0/18\text{ V},$ $R_{GS(on)} = 1\ \Omega,$ $R_{GS(off)} = 1\ \Omega, L_\sigma = 15\text{ nH},$ diode: body diode at $V_{GS} = 0\text{ V}$	$T_{vj} = 25\text{ }^\circ\text{C}$		14.8	ns
			$T_{vj} = 175\text{ }^\circ\text{C}$		14.7	
Turn-on energy	E_{on}	$V_{DD} = 800\text{ V}, I_D = 41\text{ A},$ $V_{GS} = 0/18\text{ V},$ $R_{GS(on)} = 1\ \Omega,$ $R_{GS(off)} = 1\ \Omega, L_\sigma = 15\text{ nH},$ diode: body diode at $V_{GS} = 0\text{ V}$	$T_{vj} = 25\text{ }^\circ\text{C}$		470	μJ
			$T_{vj} = 175\text{ }^\circ\text{C}$		722	
Turn-off energy	E_{off}	$V_{DD} = 800\text{ V}, I_D = 41\text{ A},$ $V_{GS} = 0/18\text{ V},$ $R_{GS(on)} = 1\ \Omega,$ $R_{GS(off)} = 1\ \Omega, L_\sigma = 15\text{ nH},$ diode: body diode at $V_{GS} = 0\text{ V}$	$T_{vj} = 25\text{ }^\circ\text{C}$		140	μJ
			$T_{vj} = 175\text{ }^\circ\text{C}$		145	
Total switching energy	E_{tot}	$V_{DD} = 800\text{ V}, I_D = 41\text{ A},$ $V_{GS} = 0/18\text{ V},$ $R_{GS(on)} = 1\ \Omega,$ $R_{GS(off)} = 1\ \Omega, L_\sigma = 15\text{ nH},$ diode: body diode at $V_{GS} = 0\text{ V}$	$T_{vj} = 25\text{ }^\circ\text{C}$		671	μJ
			$T_{vj} = 175\text{ }^\circ\text{C}$		1111	
Virtual junction temperature	T_{vj}			-55	175	$^\circ\text{C}$

3 Body diode (MOSFET)

Note: For optimum lifetime and reliability, Infineon recommends operating conditions that do not exceed 80% of the maximum ratings stated in this datasheet.

The chip technology was characterized up to 200 kV/μs. The measured dv/dt was limited by measurement test setup and package.

Dynamic test circuit see Fig. F.

3 Body diode (MOSFET)

Table 5 Maximum rated values

Parameter	Symbol	Note or test condition	Values	Unit	
Drain-source voltage	V_{DSS}	$T_{vj} \geq 25\text{ °C}$	1200	V	
Continuous reverse drain current for $R_{th(j-c,max)}$, limited by $T_{vj(max)}$	I_{SDC}	$V_{GS} = 0\text{ V}$	$T_c = 25\text{ °C}$	94	A
			$T_c = 100\text{ °C}$	58	
Peak reverse drain current, t_p limited by $T_{vj(max)}$	I_{SM}	$V_{GS} = 0\text{ V}$	213	A	

Table 6 Characteristic values

Parameter	Symbol	Note or test condition	Values			Unit	
			Min.	Typ.	Max.		
Drain-source reverse voltage	V_{SD}	$I_{SD} = 41\text{ A}, V_{GS} = 0\text{ V}$	$T_{vj} = 25\text{ °C}$		3.8	5	V
			$T_{vj} = 100\text{ °C}$		3.7		
			$T_{vj} = 175\text{ °C}$		3.6		
MOSFET forward recovery charge	Q_{fr}	$V_{DD} = 800\text{ V}, I_{SD} = 41\text{ A}, V_{GS} = 0\text{ V}, di_{SD}/dt = 3000\text{ A}/\mu\text{s}, Q_{fr}$ includes also Q_C	$T_{vj} = 25\text{ °C}$		340		nC
			$T_{vj} = 175\text{ °C}$		622		
MOSFET peak forward recovery current	I_{frm}	$V_{DD} = 800\text{ V}, I_{SD} = 41\text{ A}, V_{GS} = 0\text{ V}, di_{SD}/dt = 3000\text{ A}/\mu\text{s}, Q_{fr}$ includes also Q_C	$T_{vj} = 25\text{ °C}$		14		A
			$T_{vj} = 175\text{ °C}$		23		
MOSFET forward recovery energy	E_{fr}	$V_{DD} = 800\text{ V}, I_{SD} = 41\text{ A}, V_{GS} = 0\text{ V}, di_{SD}/dt = 3000\text{ A}/\mu\text{s}, Q_{fr}$ includes also Q_C	$T_{vj} = 25\text{ °C}$		63		μJ
			$T_{vj} = 175\text{ °C}$		254		
Virtual junction temperature	T_{vj}		-55		175	°C	

4 Characteristics diagrams

Reverse bias safe operating area (RBSOA)

$$I_{DS} = f(V_{DS})$$

$$T_{vj} \leq 175\text{ °C}, V_{GS} = 0/18\text{ V}, T_c = 25\text{ °C}$$

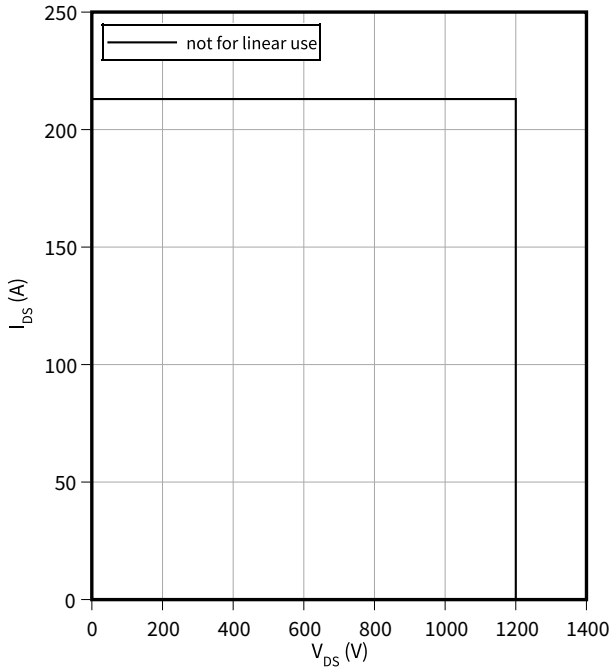

Power dissipation as a function of case temperature limited by bond wire

$$P_{tot} = f(T_c)$$

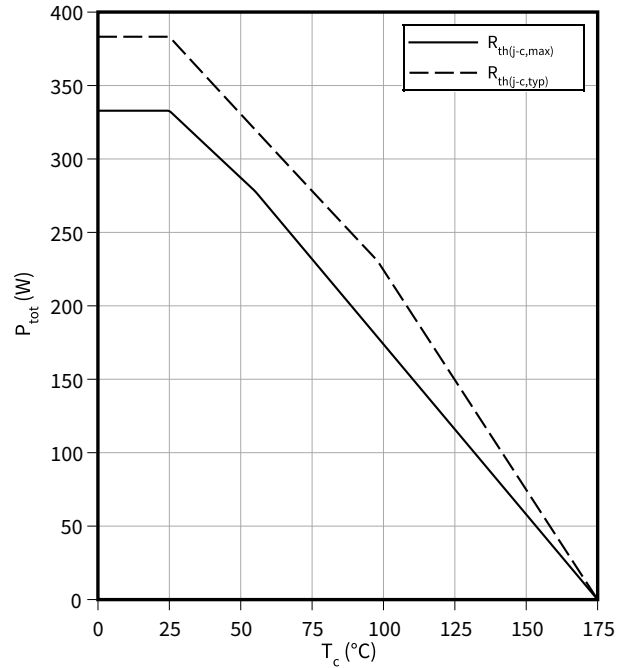

Maximum DC drain to source current as a function of case temperature limited by bond wire

$$I_{DS} = f(T_c)$$

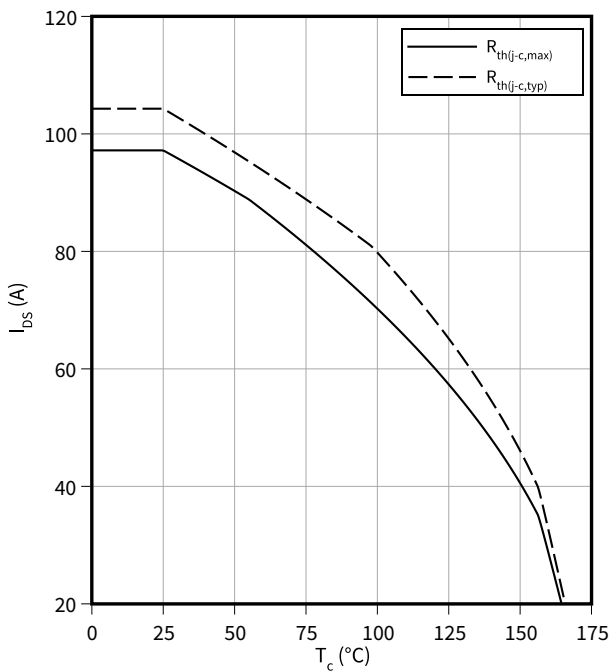

Maximum source to drain current as a function of case temperature limited by bond wire

$$I_{SD} = f(T_c)$$

$$V_{GS} = 0\text{ V}$$

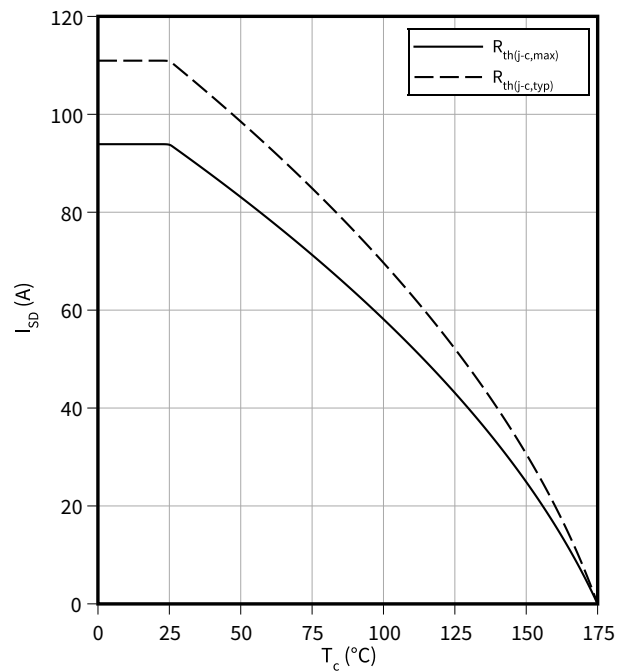

4 Characteristics diagrams

Typical transfer characteristic

$I_{DS} = f(V_{GS})$
 $V_{DS} = 20 \text{ V}$, $t_p = 20 \mu\text{s}$

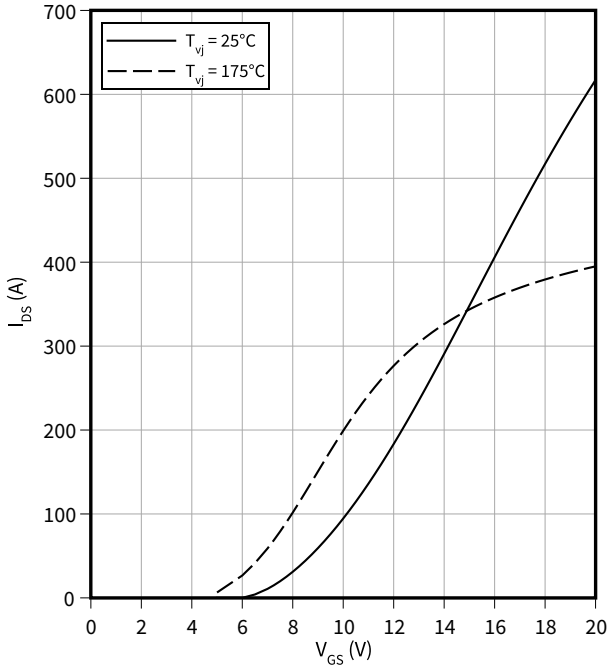

Typical gate-source threshold voltage as a function of junction temperature

$V_{GS(th)} = f(T_{vj})$
 $I_D = 17.6 \text{ mA}$

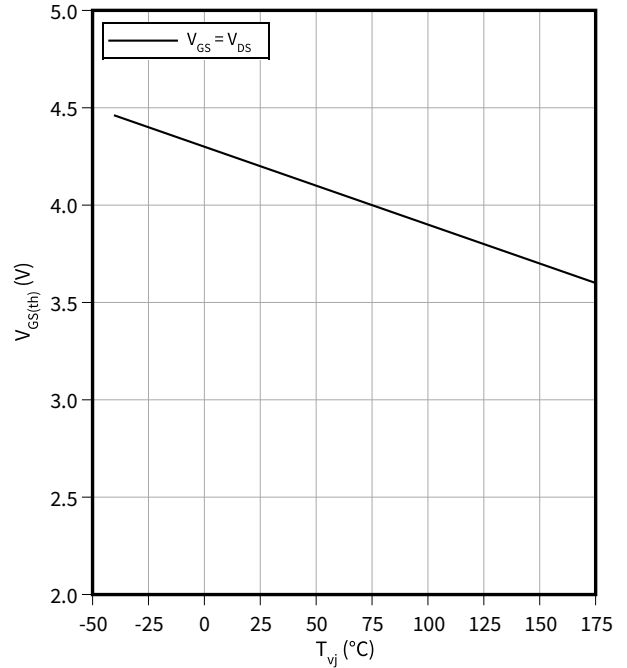

Typical output characteristic, V_{GS} as parameter

$I_{DS} = f(V_{DS})$
 $T_{vj} = 25^\circ\text{C}$, $t_p = 20 \mu\text{s}$

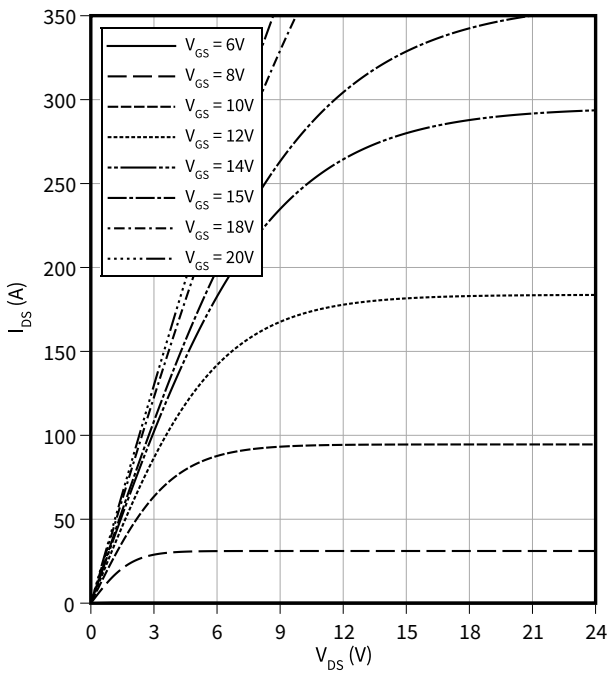

Typical output characteristic, V_{GS} as parameter

$I_{DS} = f(V_{DS})$
 $T_{vj} = 175^\circ\text{C}$, $t_p = 20 \mu\text{s}$

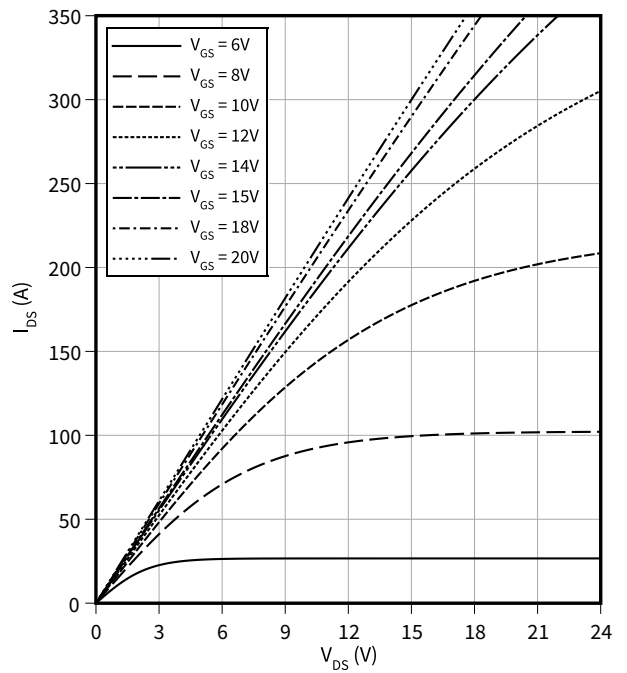

4 Characteristics diagrams

Typical on-state resistance as a function of junction temperature

$R_{DS(on)} = f(T_{vj})$
 $I_D = 41 \text{ A}$

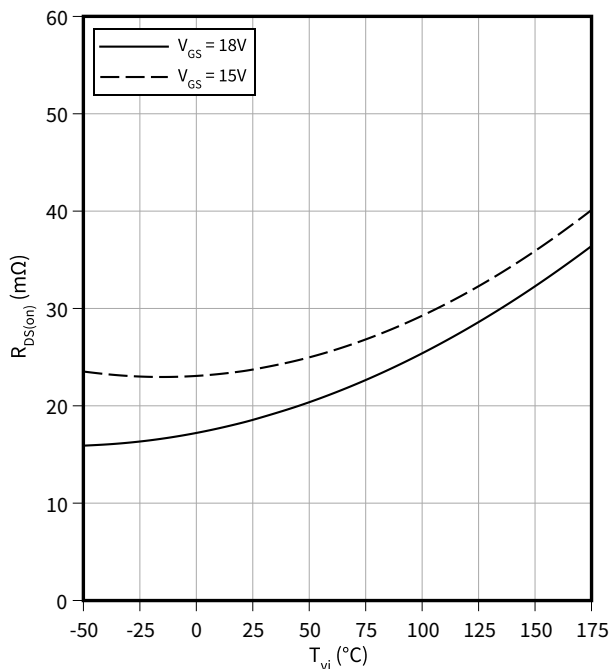

Typical gate charge

$V_{GS} = f(Q_G)$
 $I_D = 41 \text{ A}, V_{DS} = 800 \text{ V}$

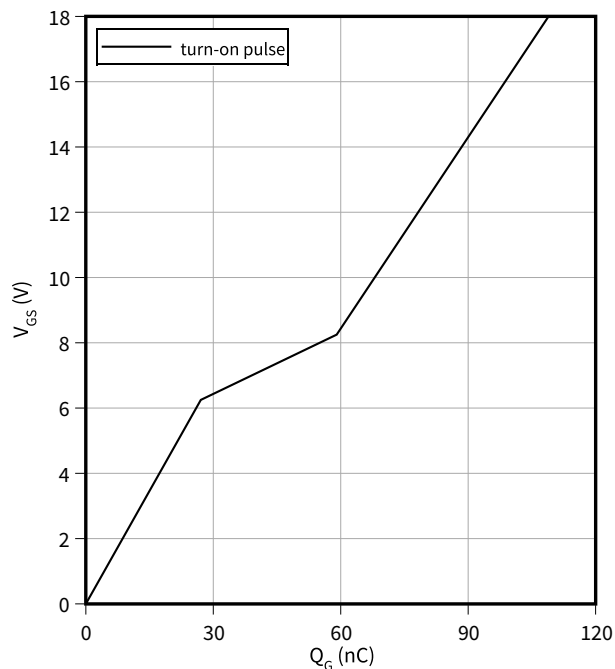

Typical capacitance as a function of drain-source voltage

$C = f(V_{DS})$
 $f = 100 \text{ kHz}, V_{GS} = 0 \text{ V}$

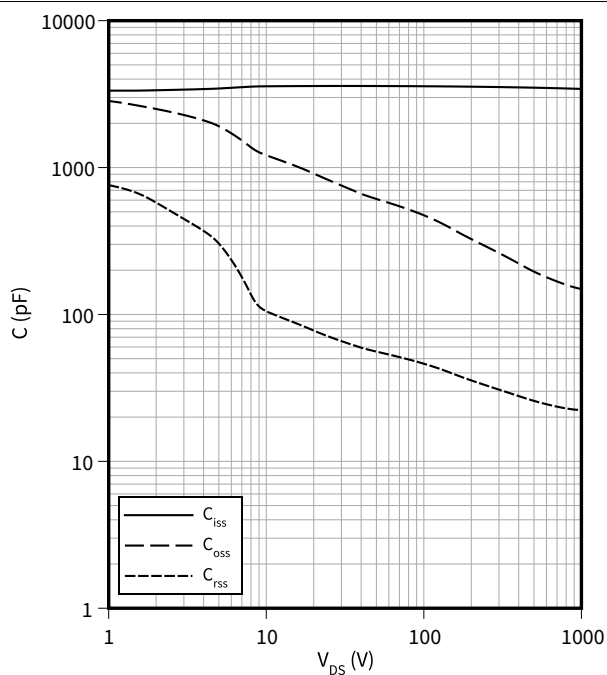

Typical reverse drain voltage as function of junction temperature

$V_{SD} = f(T_{vj})$
 $I_{SD} = 41 \text{ A}, V_{GS} = 0 \text{ V}$

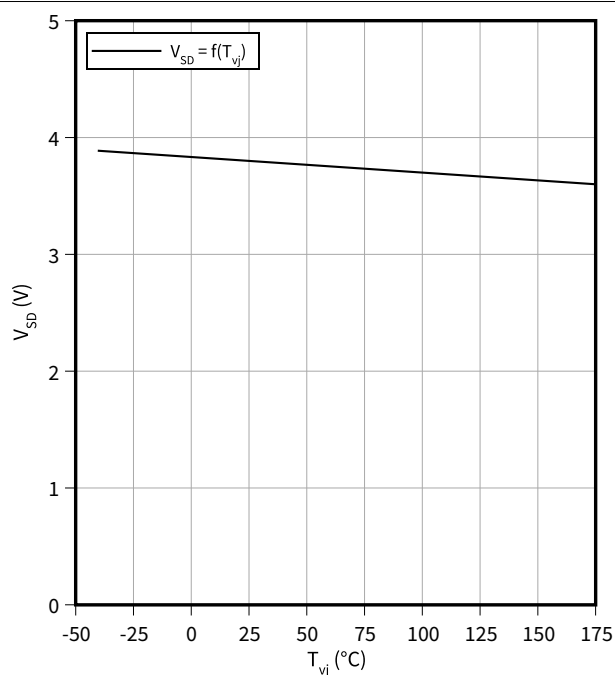

4 Characteristics diagrams

Typical reverse drain current as a function of reverse drain voltage, V_{GS} as parameter

$I_{SD} = f(V_{SD})$
 $T_{vj} = 175\text{ °C}$, $t_p = 20\text{ }\mu\text{s}$

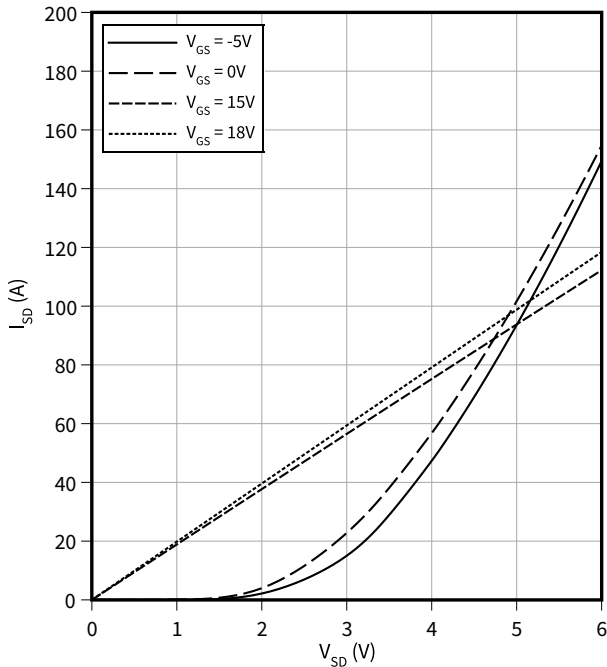

Typical reverse drain current as a function of reverse drain voltage, V_{GS} as parameter

$I_{SD} = f(V_{SD})$
 $T_{vj} = 25\text{ °C}$, $t_p = 20\text{ }\mu\text{s}$

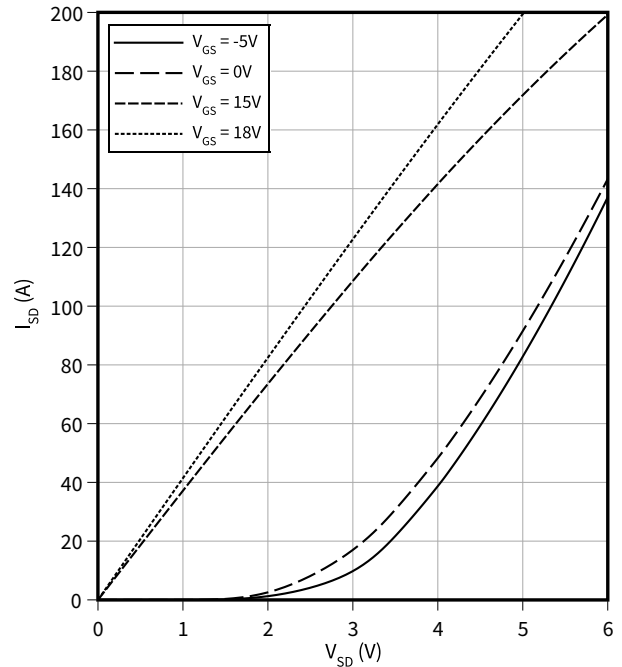

Typical switching energy as a function of junction temperature, test circuit in Fig. F, 2nd device own body diode: $V_{GS} = 0\text{ V}$

$E = f(T_{vj})$
 $I_D = 41\text{ A}$, $R_{G,ext} = 1\text{ }\Omega$, $V_{DD} = 800\text{ V}$, $V_{GS} = 0/18\text{ V}$

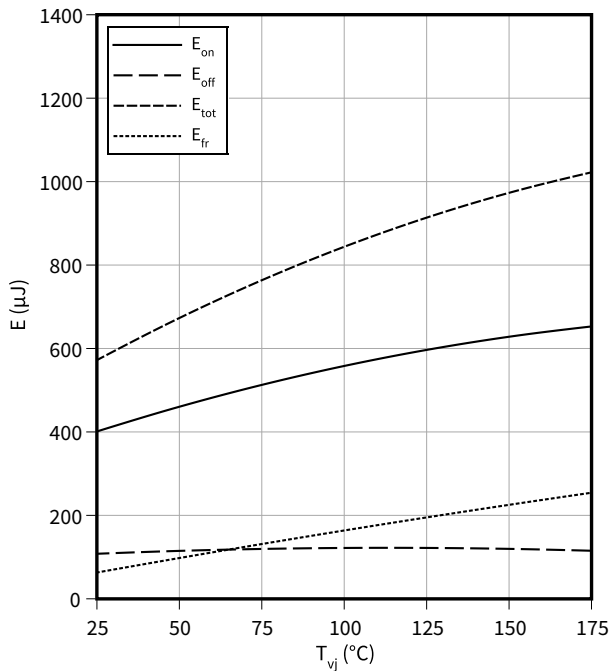

Typical switching energy as a function of drain current, test circuit in Fig. F, 2nd device own body diode: $V_{GS} = 0\text{ V}$

$E = f(I_D)$
 $V_{GS} = 0/18\text{ V}$, $T_{vj} = 175\text{ °C}$, $R_{G,ext} = 1\text{ }\Omega$, $V_{DD} = 800\text{ V}$

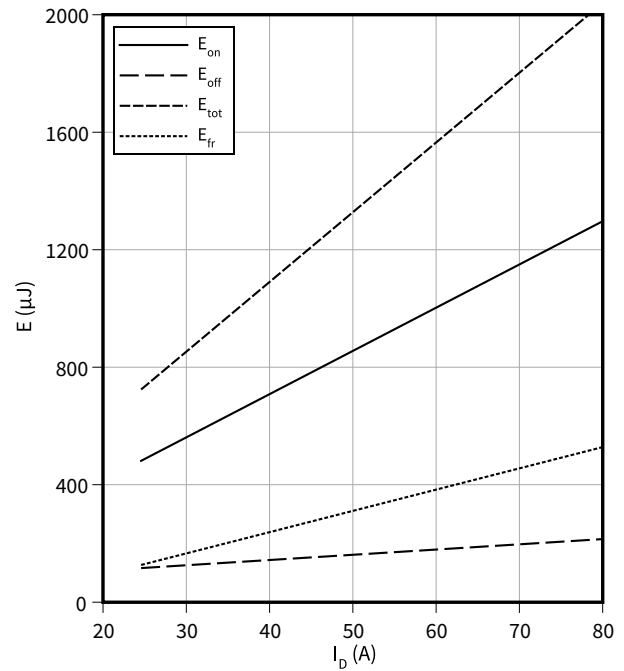

4 Characteristics diagrams

Typical switching energy losses as a function of gate resistance, test circuit in Fig. F, 2nd device own body diode: $V_{GS} = 0\text{ V}$

$E = f(R_{G,ext})$

$V_{GS} = 0/18\text{ V}$, $I_D = 41\text{ A}$, $T_{vj} = \text{°C}$, $V_{DD} = 800\text{ V}$

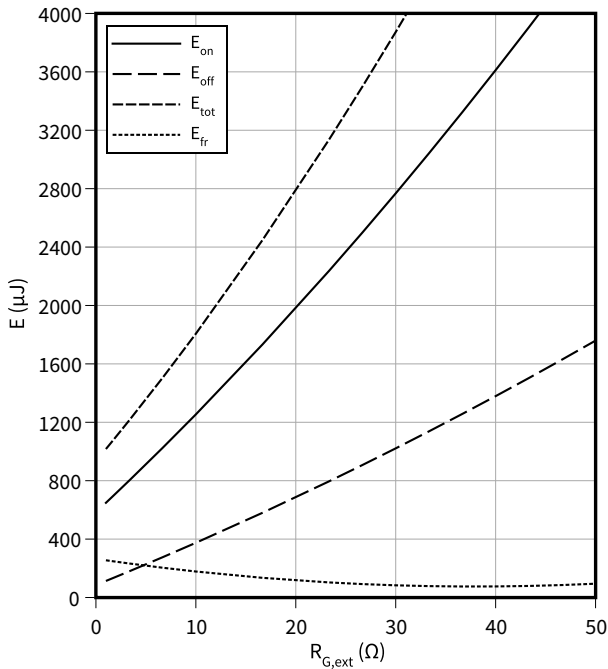

Typical switching times as a function of gate resistance, test circuit in Fig. F, 2nd device own body diode: $V_{GS} = 0\text{ V}$

$t = f(R_{G,ext})$

$V_{GS} = 0/18\text{ V}$, $I_D = 41\text{ A}$, $T_{vj} = 175\text{ °C}$, $V_{DD} = 800\text{ V}$

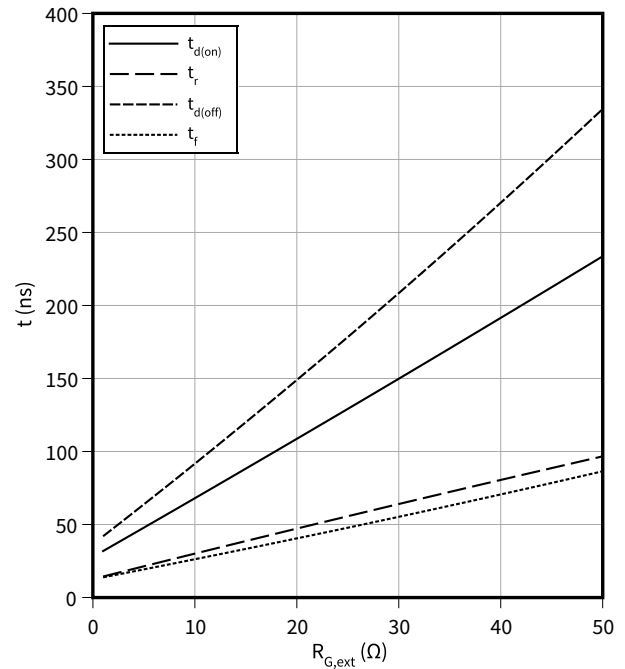

Typical reverse recovery charge as a function of reverse drain current slope, test circuit in Fig. F, 2nd device own body diode: $V_{GS} = 0\text{ V}$

$Q_{fr} = f(di_{SD}/dt)$

$V_{GS} = 0/18\text{ V}$, $I_{SD} = 41\text{ A}$, $V_{DD} = 800\text{ V}$

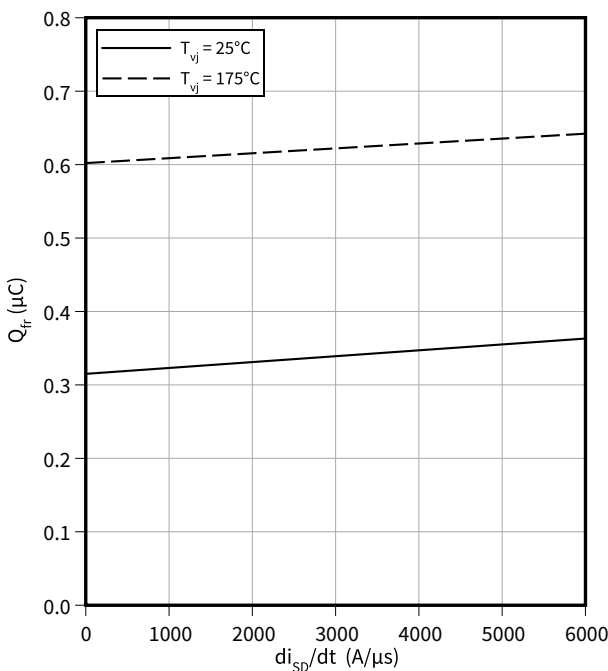

Typical reverse recovery current as a function of reverse drain current slope, test circuit in Fig. F, 2nd device own body diode: $V_{GS} = 0\text{ V}$

$I_{frm} = f(di_{SD}/dt)$

$V_{GS} = 0/18\text{ V}$, $I_{SD} = 41\text{ A}$, $V_{DD} = 800\text{ V}$

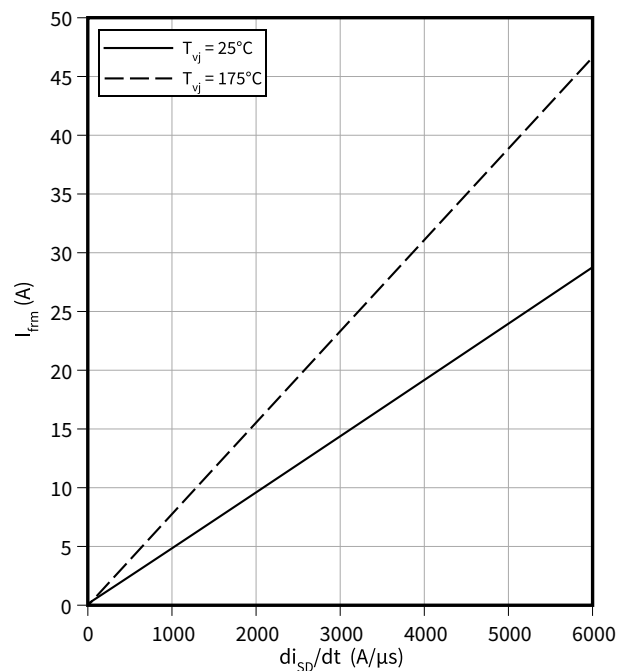

4 Characteristics diagrams

Typical switching energy losses as a function of dead time / blanking time, test circuit in Fig. F, 2nd device own body diode: $V_{GS} = -5$ V

$$E = f(t_{dead})$$

$I_D = 41$ A, $T_{vj} = 175$ °C, $V_{GS} = -5/18$ V, $V_{DD} = 800$ V

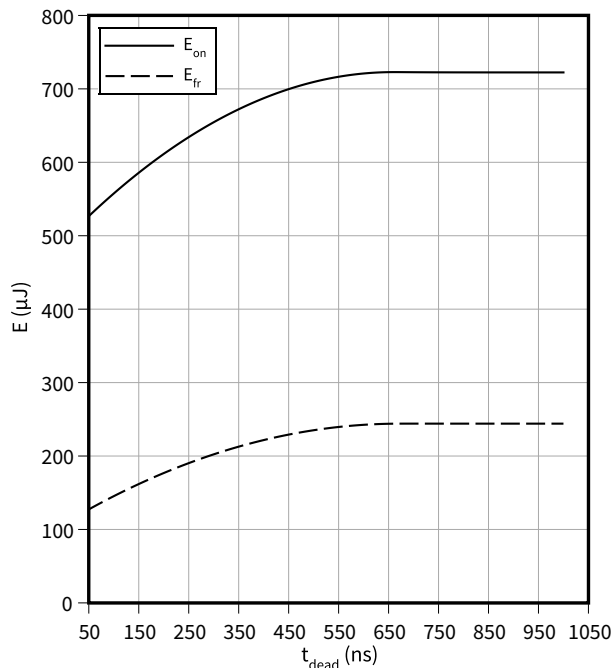

Max. transient thermal impedance (MOSFET/diode)

$$Z_{th(j-c),max} = f(t_p)$$

$$D = t_p/T$$

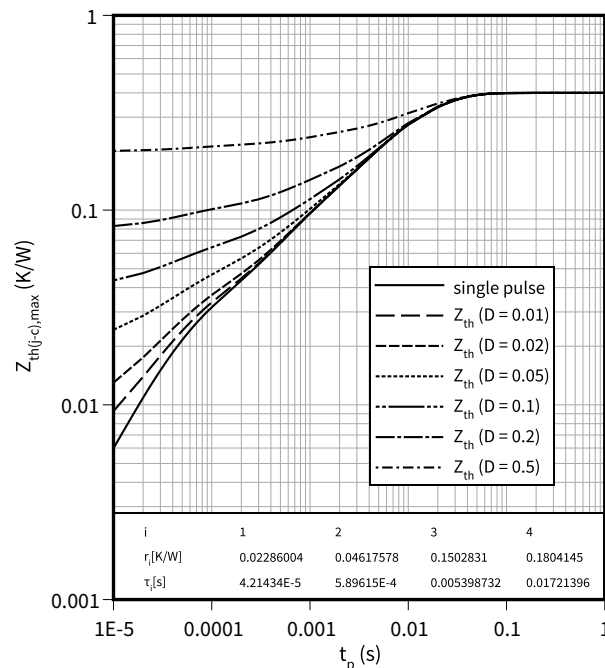

5 Package outlines

PG-TO247-4-STD-NT3.7

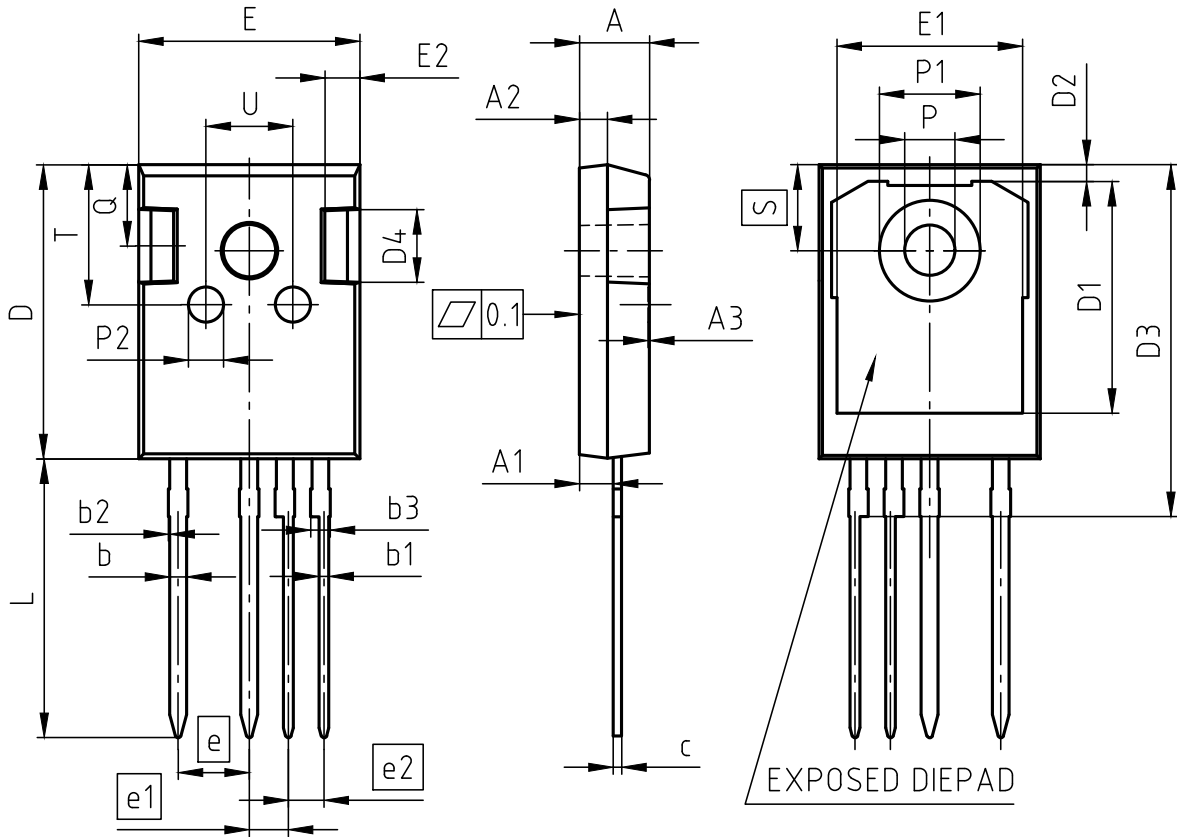

NOTES:
ALL DIMENSIONS DO NOT INCLUDE MOLD FLASH OR PROTRUSIONS.

PACKAGE - GROUP NUMBER:		PG-TO247-4-U02			
DIMENSIONS	MILLIMETERS		DIMENSIONS	MILLIMETERS	
	MIN.	MAX.		MIN.	MAX.
A	4.90	5.10	E	15.70	15.90
A1	2.31	2.51	E1	13.10	13.50
A2	1.90	2.10	E2	2.40	2.60
A3	0.05	0.25	e	5.08	
b	1.10	1.30	e1	2.79	
b1	0.65	0.79	e2	2.54	
b2	---	0.20	N	4	
b3	1.34	1.44	L	19.80	20.10
c	0.58	0.66	øP	3.50	3.70
D	20.90	21.10	øP1	7.00	7.40
D1	16.25	16.85	øP2	2.40	2.60
D2	1.05	1.35	Q	5.60	6.00
D3	24.97	25.27	S	6.15	
D4	4.90	5.10	T	9.80	10.20
			U	6.00	6.40

Figure 1

6 Testing conditions

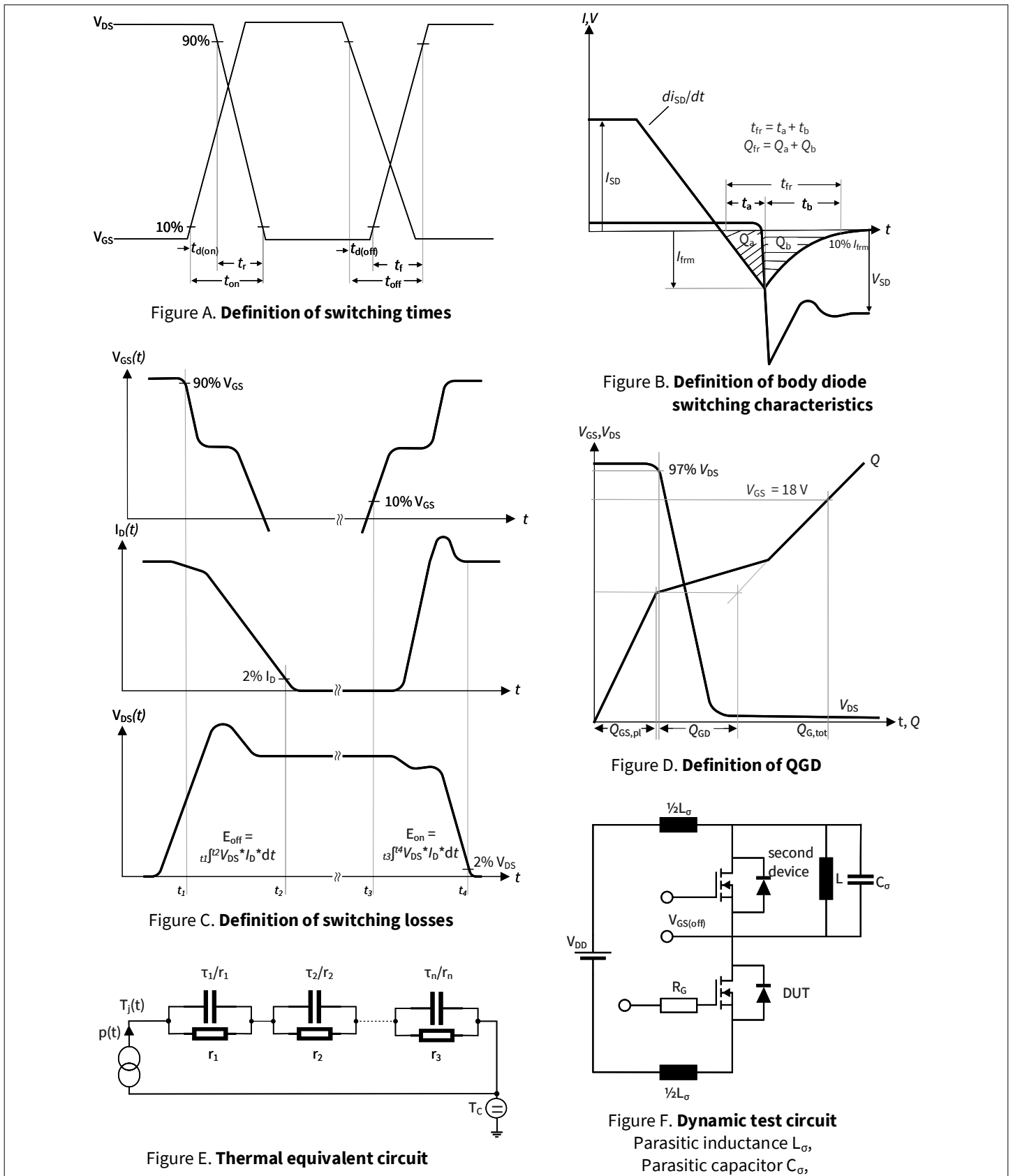

Figure 2

Revision history

Document revision	Date of release	Description of changes
1.00	2022-02-03	Final datasheet
1.10	2022-08-10	Change of test condition of dynamic capacitances in Table 4, "Characteristic values" (C_{iss} , C_{oss} , C_{rss}): $V_{DD}= 25\text{ V}$ to $V_{DD}= 800\text{ V}$ Correction of unit of "Input capacitance" C_{iss} from nF to pF Change of V_{GS} "Gate-source voltage, max. static voltage" in Table 2, "Maximum rated values" from -5/20 V to -7/20 V Editorial changes in "Features" on page 1 Editorial changes in "Package" on page 1 Correction of unit of x-axis at diagram "Max. transient thermal impedance (MOSFET/diode)" from μs to s, on page 13 Correction of diagram "Max. transient thermal impedance (MOSFET/diode)", on page 13
1.20	2023-05-08	Correction of gate charge values in Table 4 Editorial changes

Trademarks

All referenced product or service names and trademarks are the property of their respective owners.

Edition 2023-05-08

Published by

Infineon Technologies AG

81726 Munich, Germany

© 2023 Infineon Technologies AG

All Rights Reserved.

Do you have a question about any aspect of this document?

Email: erratum@infineon.com

Document reference

IFX-ABC754-003

Important notice

The information given in this document shall in no event be regarded as a guarantee of conditions or characteristics ("Beschaffheitsgarantie").

With respect to any examples, hints or any typical values stated herein and/or any information regarding the application of the product, Infineon Technologies hereby disclaims any and all warranties and liabilities of any kind, including without limitation warranties of non-infringement of intellectual property rights of any third party.

In addition, any information given in this document is subject to customer's compliance with its obligations stated in this document and any applicable legal requirements, norms and standards concerning customer's products and any use of the product of Infineon Technologies in customer's applications.

The data contained in this document is exclusively intended for technically trained staff. It is the responsibility of customer's technical departments to evaluate the suitability of the product for the intended application and the completeness of the product information given in this document with respect to such application.

Please note that this product is not qualified according to the AEC Q100 or AEC Q101 documents of the Automotive Electronics Council.



Warnings

Due to technical requirements products may contain dangerous substances. For information on the types in question please contact your nearest Infineon Technologies office.

Except as otherwise explicitly approved by Infineon Technologies in a written document signed by authorized representatives of Infineon Technologies, Infineon Technologies' products may not be used in any applications where a failure of the product or any consequences of the use thereof can reasonably be expected to result in personal injury.

Looking for pricing, stock, or lifecycle information?

Click below to explore more details on WIN SOURCE:

-  [View IMZA120R020M1HXKSA1 on WIN SOURCE](#)
-  [Infineon Technologies Information](#)

Optimize Your Supply Chain with WIN SOURCE Solutions

-  Global Sourcing Solution
-  Obsolete Management
-  Cost Control Management
-  Shortage Management
-  Alternative Solution
-  Excess Inventory Management