



THE DATASHEET OF ROE-2405S



Features

- Low cost 1W converter
- Industry standard pinout
- SIP4 package
- 1kVDC isolation
- Efficiency up to 80%
- Wide operating temperature range -40°C to +85°C
- UL60950-1 and CAN/CSA C22.2 No. 60950-1-07 certified

Unregulated Converters



ROE

1 Watt
SIP4
Single Output



Description

The ROE DC/DC converters are typically used in general purpose power isolation and voltage matching applications, and feature a full industrial operating temperature range of -40°C to +85°C without derating.

Selection Guide

Part Number	nom. Input Voltage [VDC]	Output Voltage [VDC]	Output Current [mA]	Efficiency typ. [%]	max. Capacitive Load ⁽¹⁾ [µF]
ROE-3.305S	3.3	5	200	79	470
ROE-0505S	5	5	200	79	470
ROE-0512S	5	12	84	80	220
ROE-0515S	5	15	66	80	220
ROE-1205S	12	5	200	80	470
ROE-1505S	15	5	200	79	470
ROE-2405S	24	5	200	80	470

Notes:

Note1: Max. capacitive load is tested at nominal input voltage and full load

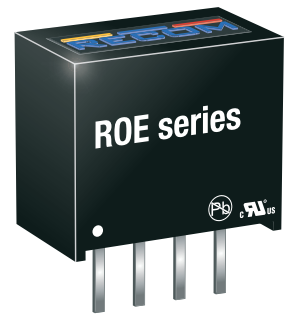

Model Numbering



Ordering Examples:

ROE-0512S = 5VDC Input Voltage, 12VDC Output Voltage, Single Output
ROE-2405S = 24VDC Input Voltage, 5VDC Output Voltage, Single Output

UL60950-1 certified
CAN/CSA C22.2 No. 60950-1-07 certified
EN60950-1 certified
IEC60950-1 certified
EN55032 compliant

Specifications (measured @ Ta= 25°C, nom. Vin, full load and after warm-up unless otherwise stated)

BASIC CHARACTERISTICS

Parameter	Condition	Min.	Typ.	Max.
Input Voltage Range			±10%	
Operating Frequency Range		50kHz	80kHz	105kHz
Output Ripple and Noise ⁽²⁾	20MHz BW		50mVp-p	100mVp-p

Notes:

Note2: Measurements are made with a 100nF MLCC across output (low ESR)

Efficiency vs. Load

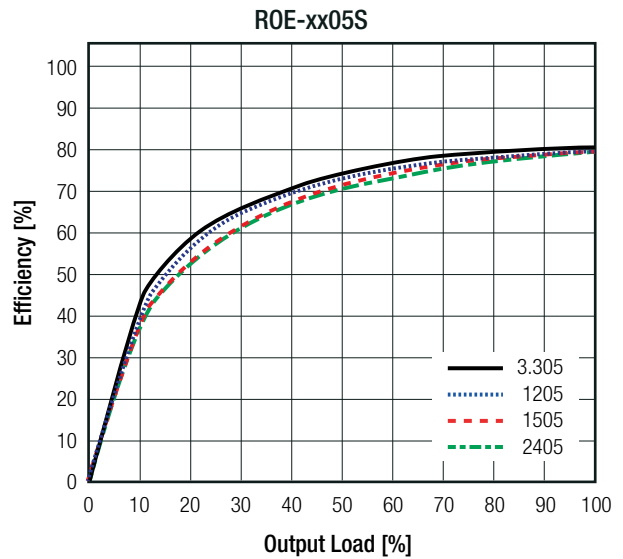
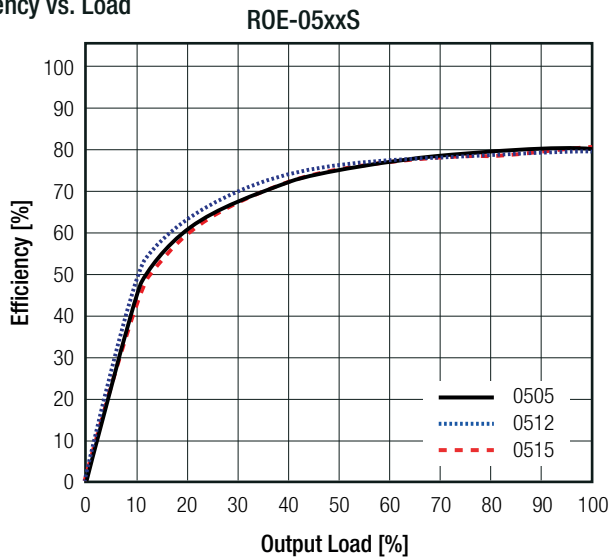

REGULATIONS

Parameter	Condition		Values
Output Accuracy			±5.0% max.
Line Regulation	low line to high line		±1.2% typ. / 1.0% Vin
Load Regulation	20% to 100% load	5Vout	15% max.
		12Vout and 15Vout	10% max.

Tolerance Envelope

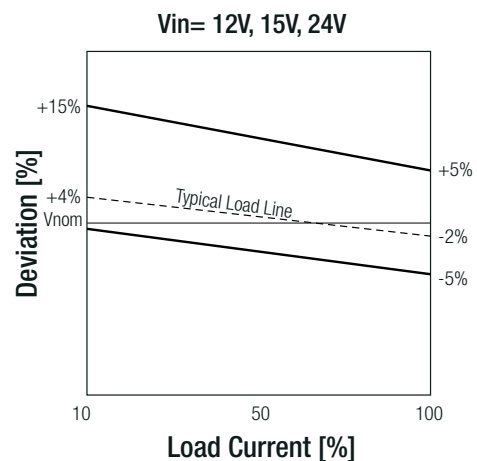
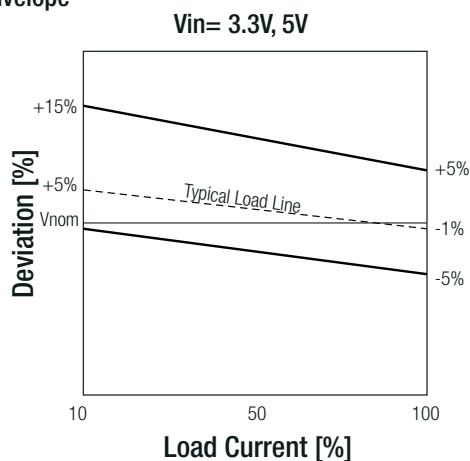

Specifications (measured @ Ta= 25°C, nom. Vin, full load and after warm-up unless otherwise stated)

PROTECTIONS

Parameter	Condition		Value
Isolation Voltage ⁽³⁾	I/P to O/P	tested for 1 second	1kVDC
Isolation Capacitance			75pF max.
Isolation Resistance			1GΩ min.

Notes:

- Note3: For repeat Hi-Pot testing, reduce the time and/or the test voltage
 Note4: An input fuse is required if the mains supply is not over-current protected. Recommended fuse: T1A slow blow type

ENVIRONMENTAL

Parameter	Condition		Value
Operating Temperature Range	without derating @free air convection (see graph)		-40°C to +85°C
Operating Humidity	non-condensing		95% RH max.
Vibration			MIL-STD-202G
MTBF ⁽⁵⁾	according to MIL-HDBK-217F; G.B.	+25°C +85°C	20140 x 10 ³ hours 8674 x 10 ³ hours

Notes:

Note5: MTBF is referring ROE-3.305S

Derating Graph

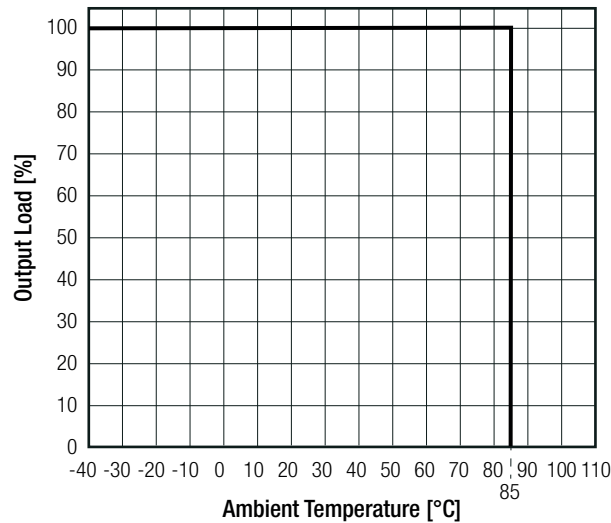

SAFETY AND CERTIFICATIONS

Certificate Type	Report / File Number	Standard
Information Technology Equipment, General Requirements for Safety	E358085-A4-UL	UL60950-1, 2nd Edition, 2007 CAN/CSA C22.2 No.60950-1-07, 2nd Edition, 2007
Information Technology Equipment, General Requirements for Safety	SPCLVD1602031	IEC60950-1:2005, 2nd Edition + A2:2013 EN60950-1:2006 + A2:2013
EAC	RU-AT.49.09571	TP TC 004/2011
RoHS 2+		RoHS-2011/65/EU + AM-2015/863

EMI Compliance	Condition	Standard / Criterion
Electromagnetic compatibility of multimedia equipment - Emission requirements	with external filter (see filter suggestion below)	EN55032, Class B EN55032, Class A

continued on next page

Specifications (measured @ Ta= 25°C, nom. Vin, full load and after warm-up unless otherwise stated)

EMC Filter Suggestion according to EN55032

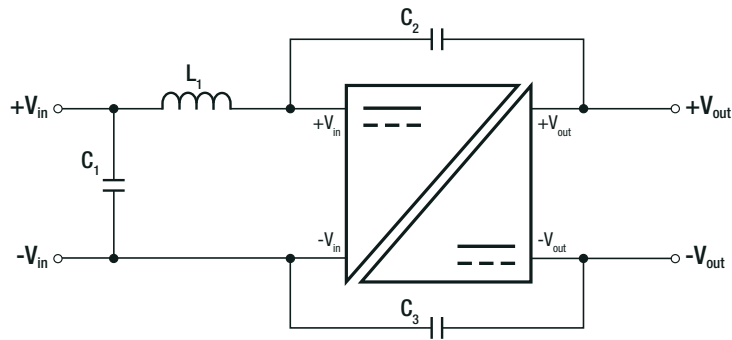

Component List Class A

MODEL	C1	L1	C2 (safety)	C3 (safety)
ROE-0505S	6.8µF, MLCC	N/A	N/A	N/A
ROE-0515S	4.7µF, MLCC		N/A	
ROE-1205S	10µF		470pF	
ROE-2405S	100V MLCC		N/A	

Component List Class B

MODEL	C1	L1	C2 (safety)	C3 (safety)
ROE-0505S	10µF 100V MLCC	22µH choke RLS-226	330pF	330pF
ROE-0515S				
ROE-1205S				
ROE-2405S				

Notes:

Note6: Filter suggestions are valid for indicated part numbers only. For other part numbers, please contact RECOM tech support for advice

DIMENSION and PHYSICAL CHARACTERISTICS

Parameter	Type	Value
Material	case potting	non-conductive black plastic, (UL94 V-0) epoxy, (UL94 V-0)
Dimension (LxWxH)		11.5 x 6.0 x 10.0mm
Weight		1.4g

Dimension Drawing (mm)

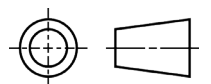
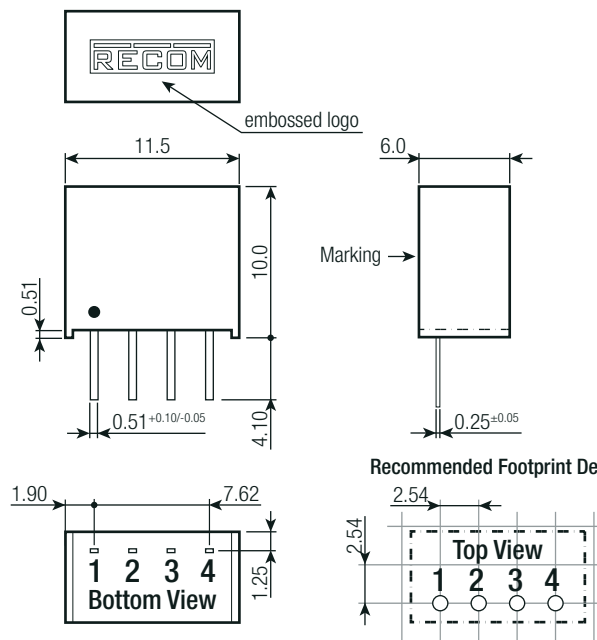

Pin Connections

Pin #	Function
1	-Vin
2	+Vin
3	-Vout
4	+Vout

Tolerance: xx.x= ±0.50mm
xx.xx=±0.25mm



Specifications (measured @ Ta= 25°C, nom. Vin, full load and after warm-up unless otherwise stated)

PACKAGING INFORMATION		
Parameter	Type	Value
Packaging Dimension (LxWxH)	tube	520.0 x 16.0 x 9.0mm
Packaging Quantity		42 pcs
Storage Temperature Range		-55°C to +125°C

The product information and specifications may be subject to changes even without prior written notice. The product has been designed for various applications; its suitability lies in the responsibility of each customer. The products are not authorized for use in safety-critical applications without RECOM's explicit written consent. A safety-critical application is an application where a failure may reasonably be expected to endanger or cause loss of life, inflict bodily harm or damage property. The applicant shall indemnify and hold harmless RECOM, its affiliated companies and its representatives against any damage claims in connection with the unauthorized use of RECOM products in such safety-critical applications.

Looking for pricing, stock, or lifecycle information?

Click below to explore more details on WIN SOURCE:

-  [View ROE-2405S on WIN SOURCE](#)
-  [Recom Power Information](#)

Optimize Your Supply Chain with WIN SOURCE Solutions

-  Global Sourcing Solution
-  Obsolete Management
-  Cost Control Management
-  Shortage Management
-  Alternative Solution
-  Excess Inventory Management