



**THE DATASHEET OF
CT10-1030-G1**



1 Description

The CT10 is an overmolded dry reed switch. It is single-pole, single throw (SPST) type, having normally open ruthenium contacts.

The sensor is a double-ended type and may be actuated with an electromagnet, a permanent magnet or a combination of both.

The device is designed for SMD mounting and is available in three lead configurations.

Device Information

Part Series	Package	Body Size (mm)
CT10	Molded SMD	15.72 x 2.41 x 2.4 (A2)
		16.38 x 2.92 x 2.41 (G1)
		19.68 x 2.92 x 2.41 (G2)
		19.7 x 2.92 x 2.41 (G4)

2 Features

- ▶ Ideal for SMD pick and place
- ▶ Tape and reel packaging
- ▶ 10W rating
- ▶ Rugged encapsulation
- ▶ Excellent life and reliability
- ▶ UL File 67117
- ▶ RoHS compliant

3 Applications

- ▶ Proximity Sensing
- ▶ Security Alarm Sensor
- ▶ Level Sensor
- ▶ Flow Sensor
- ▶ Pulse Counter

Device Packages

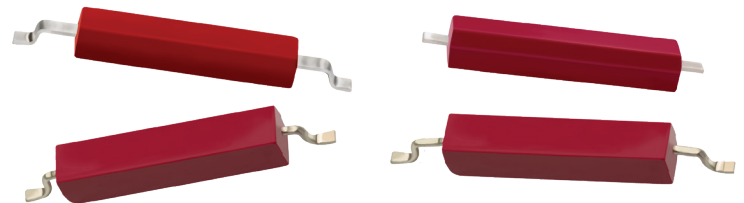

4 Ordering Information

A complete part number is represented by the digits to the right of the CT10 series prefix followed by a suffix as shown below.

EXAMPLE: CT10-1030-G1 is a CT10 sensor (10mm encapsulated switch) with a sensitivity range from 10 to 30AT lead ends are formed according to the G1 version

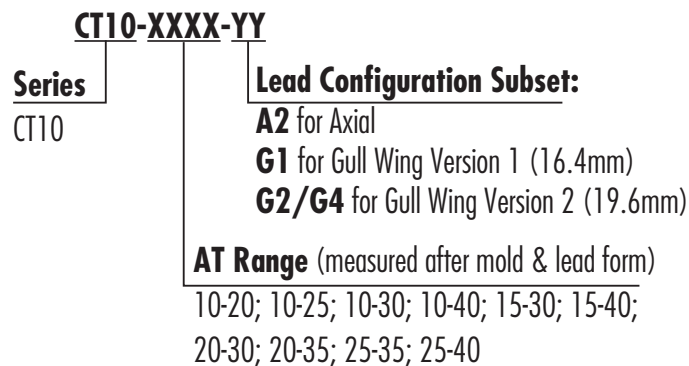

5 Specifications for CT10

5.1 Operating / Environmental Ratings for CT10-XXXX-YY

Parameters	Units	Min	Type	Max
Operating Range	AT	10		40
Release Range	AT	3		39
Storage Temperature	°C	-40		125
Operating Temperature	°C	-40		125
Vibration Resistance	G		10	
Shock Resistance	G		100	

Notes:

1. AT values measured using a Philips 10JK coil.
2. Surface mount component processing temperature Model G1 & G2: 500°F(260°C) max peak; Model G4 & A2: 439°F(226°C) max peak.
See Section 8 for Profile Recommendations.
3. Temperature measured on leads where lead exits molded package.

5.2 Electrical Characteristics for CT10-XXXX-YY

Parameters	Units	Min	Typ	Max
Switched Power	W			10
Switched Voltage DC	V			200
Switched Voltage AC, RMS value	V			140
Switched Current DC	mA			500
Switched Current AC, RMS value	mA			500
Carry Current DC	mA			500
Breakdown Voltage	V	230		
Life Expectancy @ 1V, 10mA	10 ⁶ hours	1000		
Life Expectancy @ 10V, 10mA	10 ⁶ hours	500		
Contact Resistance	mΩ			200
Insulation Resistance	MΩ	10 ⁶		
Dielectric Strength	VDC	230		

5 Specifications for CT10

5.3 Operating Characteristics for CT10-XXXX-YY

Part Number	Parameters	Units	Min	Typ	Max
CT10-1020-YY	Operating Range	AT	10		20
	Release Range	AT	3		19
CT10-1025-YY	Operating Range	AT	10		25
	Release Range	AT	3		24
CT10-1030-YY	Operating Range	AT	10		30
	Release Range	AT	3		29
CT10-1040-YY	Operating Range	AT	10		40
	Release Range	AT	3		39
CT10-1530-YY	Operating Range	AT	15		30
	Release Range	AT	3		29
CT10-1540-YY	Operating Range	AT	15		40
	Release Range	AT	3		39
CT10-2030-YY	Operating Range	AT	20		30
	Release Range	AT	3		29
CT10-2035-YY	Operating Range	AT	20		35
	Release Range	AT	3		34
CT10-2535-YY	Operating Range	AT	25		35
	Release Range	AT	3		34
CT10-2540-YY	Operating Range	AT	25		40
	Release Range	AT	3		39

6 Dimensions Inches (Millimeters)

6.1 CT10-XXXX-G1

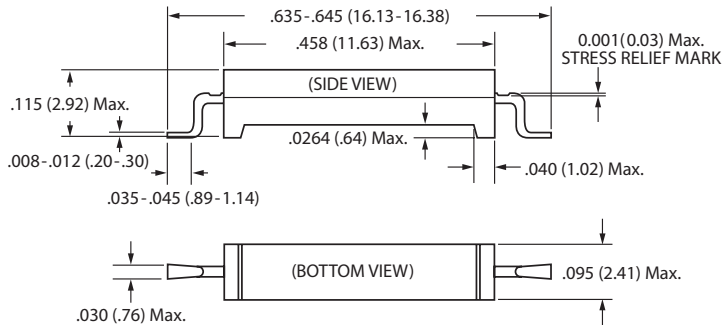

6.2 CT10-XXXX-G2

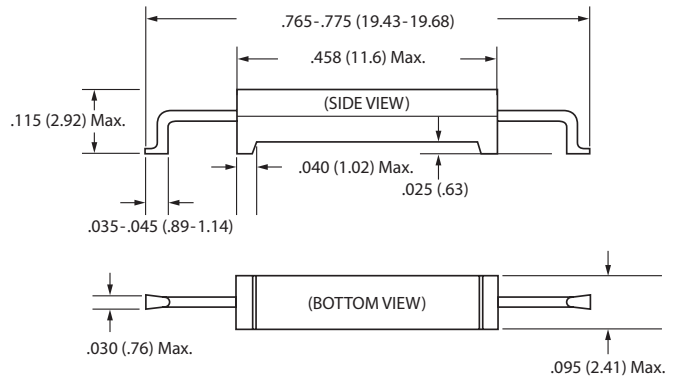

6.3 CT10-XXXX-G4

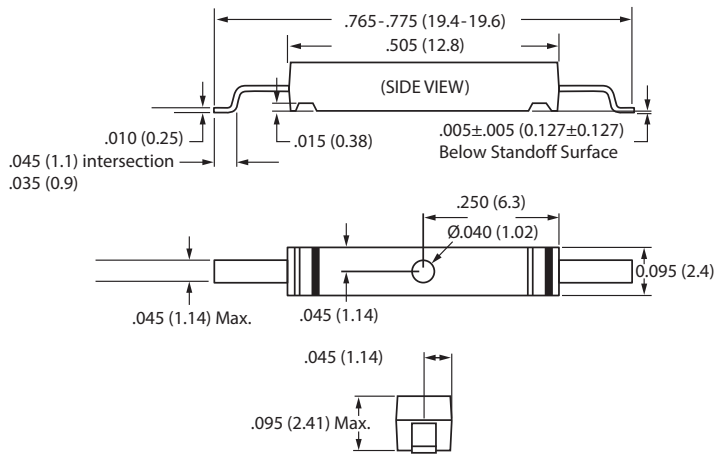

6.4 CT10-XXXX-A2

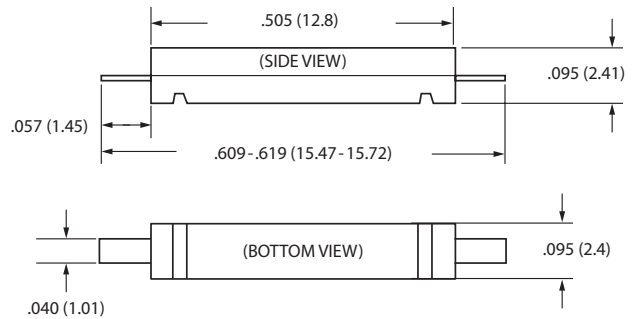

7 CT10 Reel & Carrier Tape Packaging

7.1 CT10-XXXX-G1 and CT10-XXXX-A2 Carrier Tape

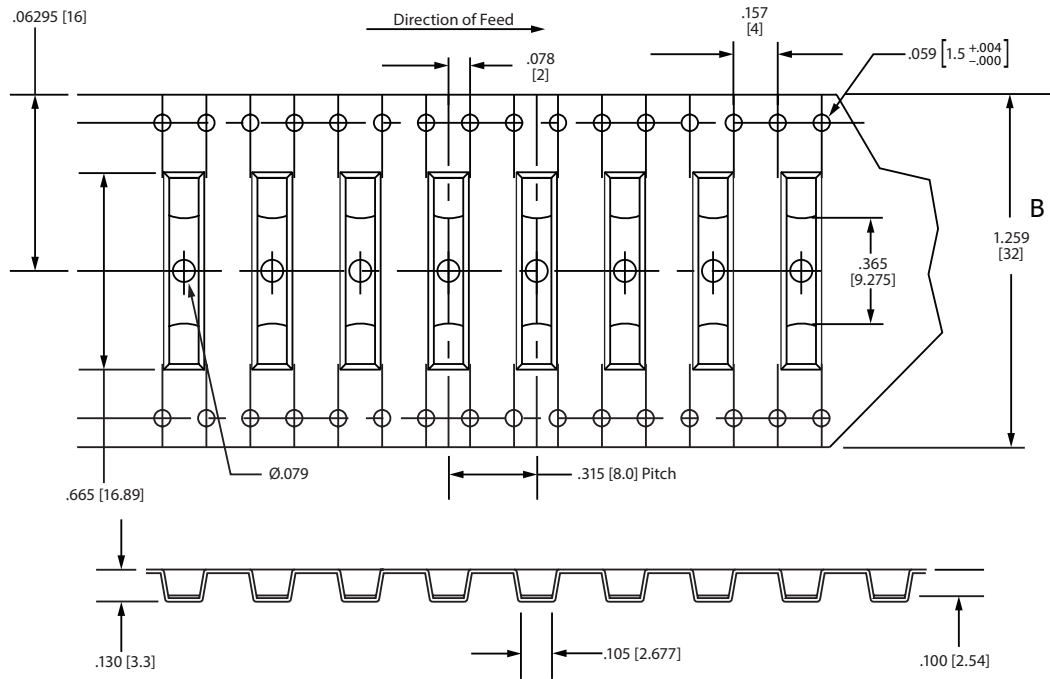

- Notes:
1. All tape and sprocket hole dimensions are per EIA-481 unless noted.
 2. All pocket dimensions are $\pm .005^\circ$.

7.2 CT10-XXXX-G2 and CT10-XXXX-G4 Carrier Tape

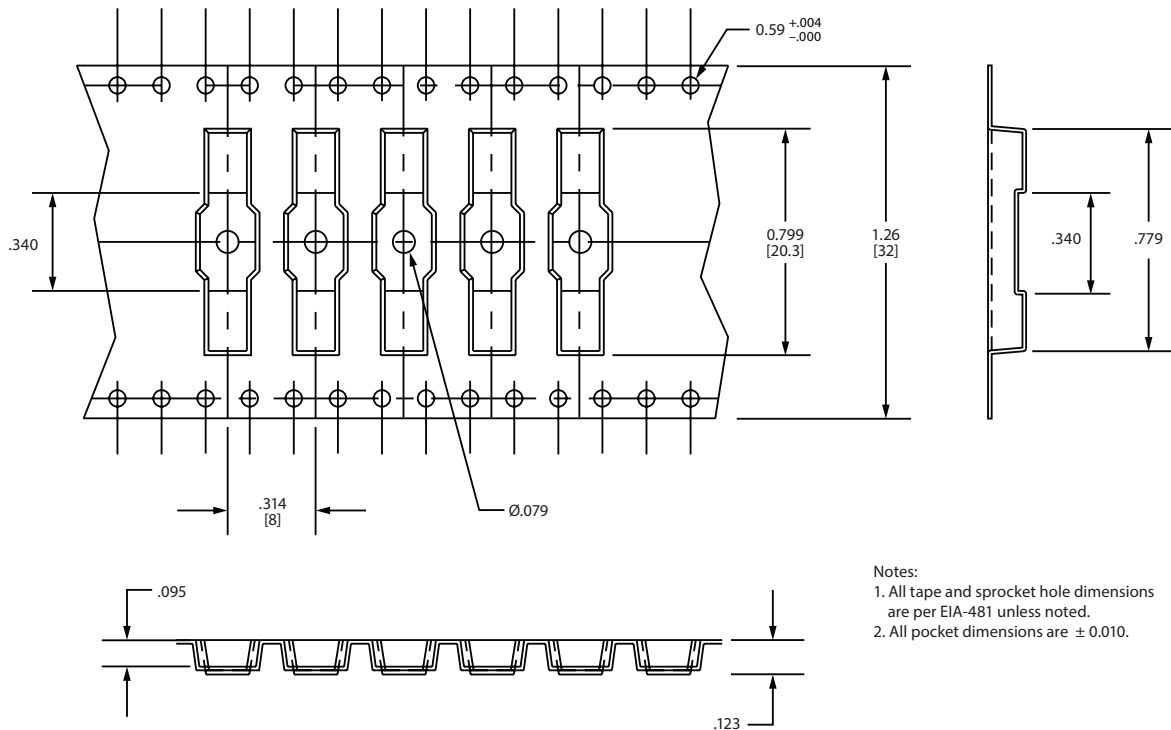

- Notes:
1. All tape and sprocket hole dimensions are per EIA-481 unless noted.
 2. All pocket dimensions are ± 0.010 .

7 CT10 Reel & Carrier Tape Packaging

7.3 CT10 Reel Packaging

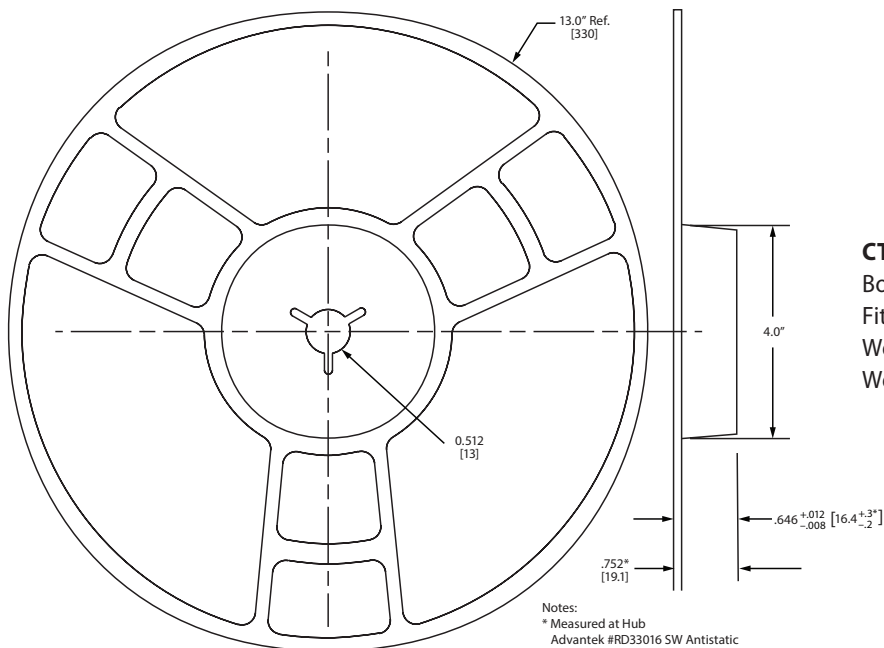

CT10 Packaging

Box Dimensions - 14x14x6 inches
 Fits 1 to 3 reels = 2000 to 6000 pcs
 Weight for 2000 pcs: 1.20 kilos
 Weight for 6000 pcs: 2.90 kilos

8 Recommended Reflow Profile SAC Alloy

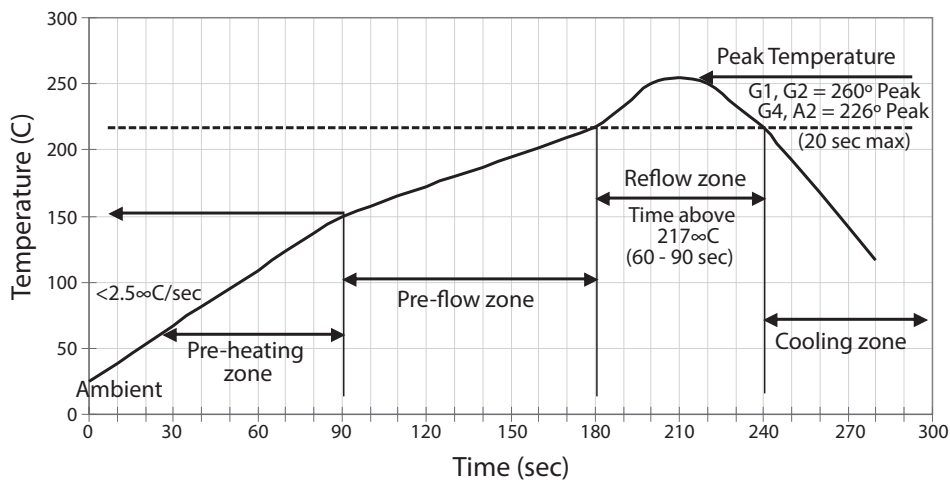

9 Recommended Pad Layouts for SMD Reed Switches

Model	Lead Type	Fig. #	Dim. A	Dim. B	Dim. C	Dim. D
CT10	A2	1	.666/16.92	.529/13.44	.069/1.74	.050/1.27
CT10	G1	1	.692/17.57	.520/13.20	.086/2.18	.041/1.04
CT10	G2	1	.822/20.87	.640/16.25	.091/2.31	.057/1.45
CT10	G4	1	.822/20.87	.640/16.25	.091/2.31	.057/1.45

(Dimensions in Inches/Millimeters)

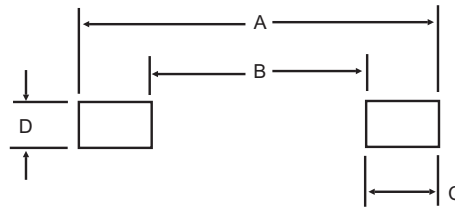

10 Glossary of Terms

Dry-Reed Switch: A dry-reed switch is an assembly containing ferromagnetic contact blades, hermetically sealed in a glass envelope and operated by an externally-generated magnetic field, e.g., that from an actuating coil.

Operate Value: The ampere turn value at which normally-open contacts close. Lower value reflects higher sensitivity.

Operate Time: The operate time is the time between the instant of application of a magnetic field to a dry-reed switch and the instant of the first physical closing of this switch. The operate time does not include bounce time.

Release Value: The ampere turn value at which normally-open contacts, held closed by a magnetic field, will reopen as field strength is reduced.

Release Time: The release time is the time between the instant of removal of an applied magnetic field to a dry-reed switch and the instant of the first physical opening of this switch. The release time does not include bounce time.

Bounce: Bounce is a momentary opening of a switch after initial closing, or a momentary closing after initial opening.

Bounce Time: The bounce time is the interval of time between the instant of initial closing (or opening) and the instant of final closing (or opening) of the dry-reed switch.

Dry-Reed Switch Contact Resistance: The dry-reed switch contact resistance is the resistance of the dry-reed switch under specified conditions of measurement.

Saturate Value: The saturate value is defined as the value of the applied magnetic field at which the dry-reed switch is unaffected by further increase of the applied magnetic field.

11 Reed Switch Characteristics

Operate and Release Values

Operate and release values are dependent on the measuring coil, the rate of energization (0.1 AT/ms), the detection of the operate (closing) and the release (opening) moment, the position of the measuring coil relative to the earth's magnetic field and on the environmental conditions.

Operate and Release Times

The operate and release times are dependent mostly on the energization and de-energization rate. They are proportional to the R/L time of the coil. Operate time is inversely proportional to the ratio of energization to operate value. Release time is proportional to the ratio of energization to release value.

Bounce Time

The bounce time is almost independent of the energization, however, a high energization gives a somewhat shorter bounce time. The bounce time is dependent on the current to be switched; above approximately 100 mA the bounce time is almost zero.

Contact Resistance

The contact resistance is dependent on the wire composition, wire diameter, energization and contact layer. The published contact resistance is measured with an open contact voltage of 20 mV and a current through the closed contacts of 10 mA, using the 4-point method (Kelvin method). Distance between measuring points for all switch types is 41 mm.

Breakdown Voltage

The breakdown voltage depends on the gap between the contact blades, kind of gas filling, gas pressure, material of the contact layer and the availability of free electrons in the gas. The first three items are set by the design of a particular reed switch. The last item is very dependent on ambient conditions. Therefore minimum values are given in the published data.

Insulation Resistance

The insulation resistance is dependent on the condition of the inside of the glass envelope and on the environment, e.g. relative humidity, conducting layers on the outside of the glass envelope.

Life Expectancy

The life of a dry-reed switch is influenced by the contact layer, the mechanical characteristics of the reed switch blade, the load, the load circuit parameters and the applied magnetic field. The contact layer and the blade characteristics are determined by the manufacturer. Load, load circuit parameters and magnetic field are determined by the user. The load should be within the maximum published values. The load circuit parameters (wiring capacitance and inductance), should be kept as low as possible and the applied magnetic field must be stronger than necessary for obtaining the maximum operate value.

Remark: Due to the influence of the load circuit on contact resistance and sticking, and also the influence of the applied magnetic field and used coil or magnet, life-test information can only be compared when it is the result of testing under exactly the same conditions (test equipment).

Coils:

The electrical characteristics are measured using either the NARM1 coil or the 10JK coil. Using another coil may change these characteristics. The measuring method e.g. speed, detection and the position of the coil with respect to the earth's magnetic field may also affect the characteristics. The definitions of the NARM1 coil and the 10JK coil are as follows:

10JK Coil: 10000 turns of 47 SWG single enameled copper wire on an elliptical coil former of 12.5 mm winding length.

NARM 1 Coil: 5000 turns of 46 AWG single enameled copper wire on an elliptical coil former of 10.4 mm winding length.

12 Reed Switch Operation Methods

Operation Using a Coil

Figures 12.1, 12.2 and 12.3 illustrate the various methods of operating the switch using a coil.

With the method given in Fig. 12.3, the dry-reed switch and/or permanent magnet can be placed either within or outside the coil.

12.1: A dry-reed switch mounted within a coil

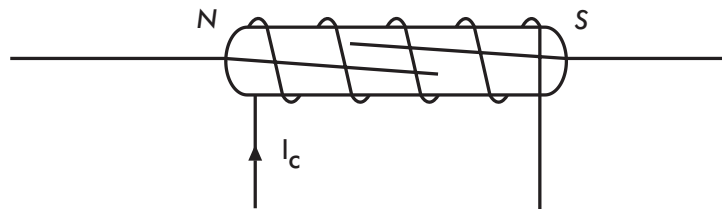

12.2: A dry-reed switch mounted outside a coil

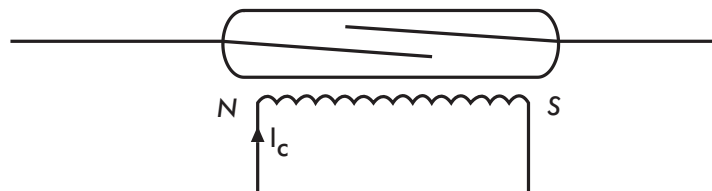

12.3: A dry-reed switch biased by a permanent magnet and operated by a coil

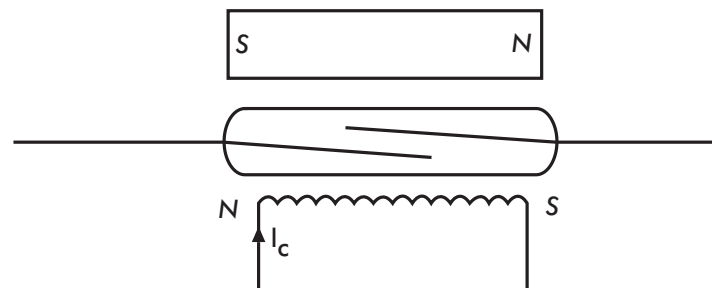

13 Operation Using a Permanent Magnet

Permanent magnets are also often used to operate dry-reed switches. Figures 13.1, 13.2, 13.3 and 13.4 illustrate the various methods available.

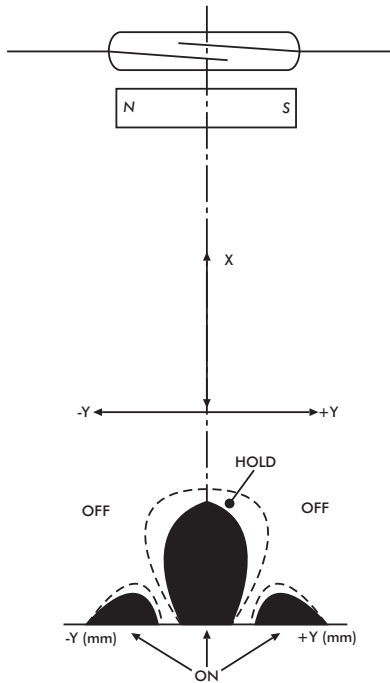

13.1: Movement, with the magnetic field parallel to the dry-reed switch

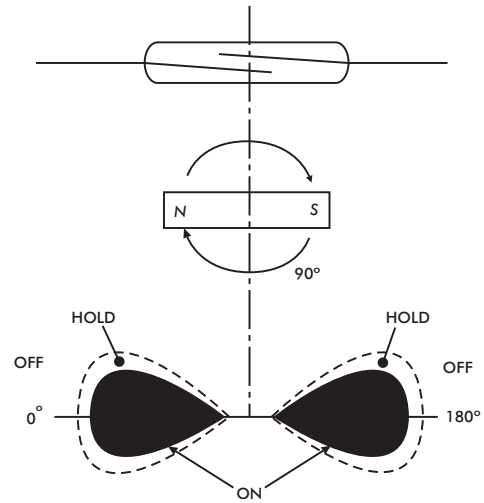

13.2: Rotational movement with a bar shaped permanent magnet

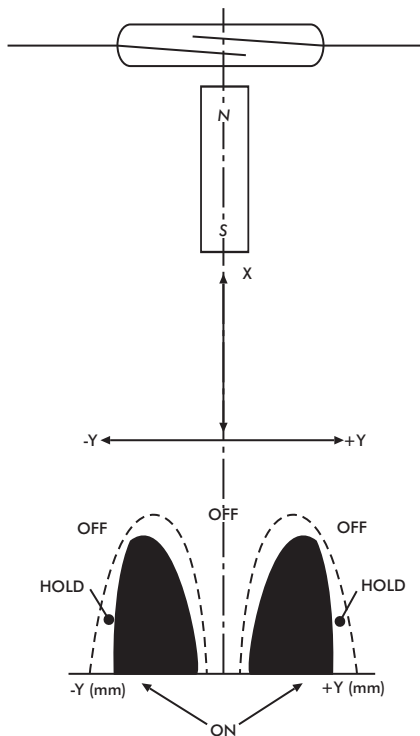

13.3: Movement, with the magnetic field perpendicular to the dry-reed switch

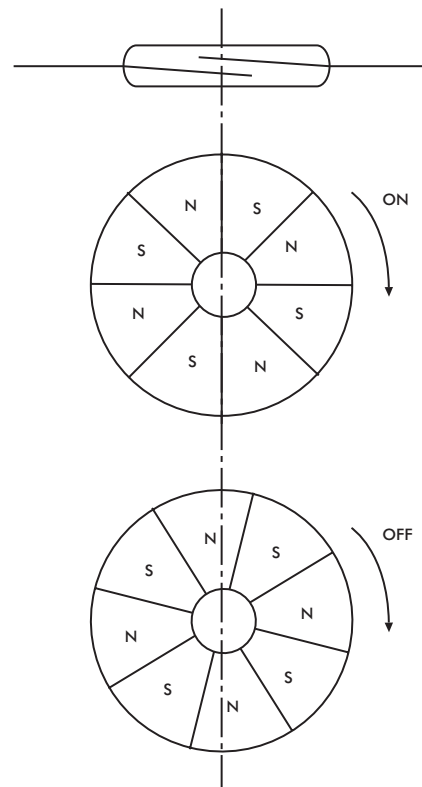

13.4: Rotational movement with two or more pole ring magnets

14 Shielding

Ferromagnetic materials which shunt the magnetic fields may be used to shield a dry-reed switch (see Fig. 14.1).

14.1: Shielding a magnetically operated switch

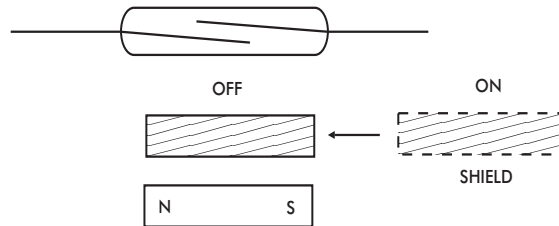

15 Magnetic Application

There are many applications for dry-reed switches used in combination with a permanent magnet. Figure 15.1 shows the relationship between the Gauss values of a permanent magnet and the AT values of Coto dry-reed switches in the Philips Standard Coil. It enables the customer to determine which reed switch AT range can be used in combination with a specific permanent magnet. Please note that this relationship is an approximation specifically for Coto dry-reed switches only.

15.1: Relationship between the field strength of a permanent magnet and the ampere-turn values of Coto reed switches in the Philips Standard Coil

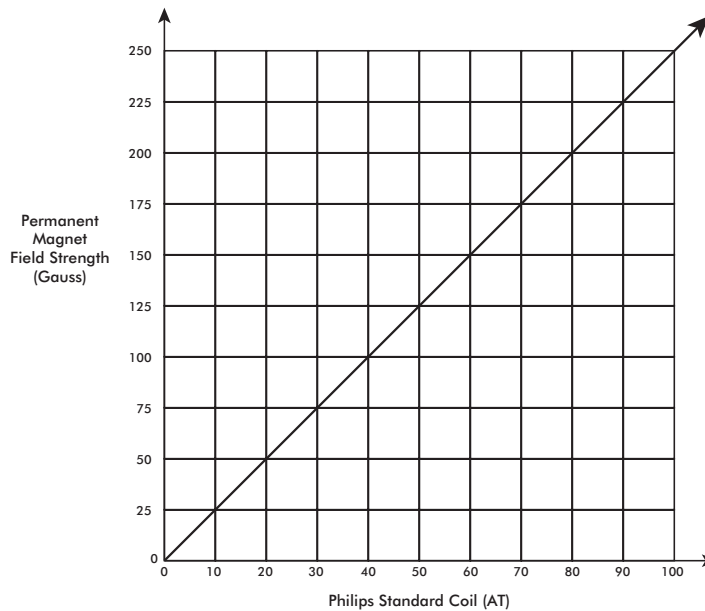

16 Switching Considerations: Application Information

Should your application require further information, please consult your nearest Coto Technology sales office.

17 Switching Considerations: Contact Protection

Unless stated otherwise, the published life-expectancy data is based on resistive loads. For inductive, capacitive or lamp loads, inrush current or reverse voltage can affect the life of a reed switch. For a maximum life-time, contact protection is advised.

17.1 Inductive Loads

To reduce the high reverse voltage produced when a reed switch opens, the following contact protection can be applied:

DC voltage: a diode parallel to the load or the reed switch (see Fig. 17.1.1).

AC voltage: An RC-network parallel to the load or the reed switch (see Fig. 17.1.2).

17.1.1: DC voltage contact protection

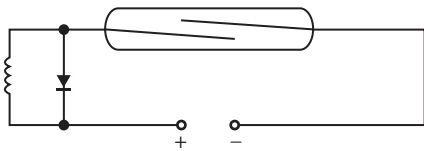

17.1.2: AC voltage contact protection

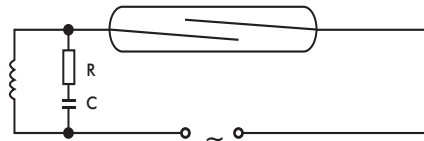

$$C = \frac{I^2}{10}$$

and

$$R = \frac{U}{10 \left(1 + \frac{50}{U} \right)}$$

where: C in μF ; I in A; R in Ω ; U in V.

17.2 Capacitive Loads

To reduce the high inrush current when a reed switch closes, a resistor must be connected in series with the capacitance or the reed switch.

When wiring a load and reed switch over a long distance, electrostatic capacitance, arising from the cable, can damage the reed switch. To protect against this capacitance a series surge protector (L) or a resistor should be connected in series.

17.3 Lamp Loads

To reduce the high inrush current when a cold incandescent lamp has to be switched by a reed switch (closing only), a resistor must be connected in series with the lamp or parallel to the reed switch.

Looking for pricing, stock, or lifecycle information?

Click below to explore more details on WIN SOURCE:

 [View CT10-1030-G1 on WIN SOURCE](#)

 [Coto Technology](#) Information

Optimize Your Supply Chain with WIN SOURCE Solutions

-  Global Sourcing Solution
-  Obsolete Management
-  Cost Control Management
-  Shortage Management
-  Alternative Solution
-  Excess Inventory Management