

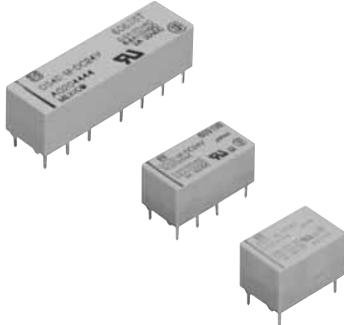

THE DATASHEET OF DS4E-SL2-DC5V





FEATURES

1. Breakthrough height of 9.8 mm .386 inch beats the 10 mm .394 inch limit

1c, 2c, and 4c all have the same height (9.8 mm .386 inch). The width of the relay is also the same (9.9 mm .390 inch). Since the only size variable is the length, the shared form makes mounting on printed printing wiring boards easy.

2. Suitable for use in difficult environments

Epoxy resin seals the parts and cut off the external atmosphere, thus enabling use in difficult environments.

3. Can be used with automatic solder and automatic wash systems

Automatic soldering and automatic washing can be carried out once the parts are mounted on PC boards.

4. Gold-clad twin contacts ensure high reliability

Highly stable gold cladding on the contacts ensures that contact resistance changes little over time. Furthermore, the use of twin contacts, a configuration that performs with superior contact reliability, ensures extremely low contact failure rates even under low level loads.

5. Polarized magnetic circuits realize resistance to shock and vibration

High-performance polarized magnetic circuits that utilize the energy of permanent magnets have made it possible to create relays with strong resistance to shock and vibration.

6. DIL terminal array enables use of IC sockets

7. Widening scope of application with multicontact latching

In addition to single side stable types, you can take advantage of the memory of functions of convenient 1 coil or 2 coil latching relays.

RoHS Directive compatibility information
<http://www.mew.co.jp/ac/e/environment/>

TYPICAL APPLICATIONS

Besides telecommunications, measuring devices, office equipment, computers and related equipment, DS relays are also recommended for a broad range of applications including business devices, audio systems, and industrial equipment.

ORDERING INFORMATION

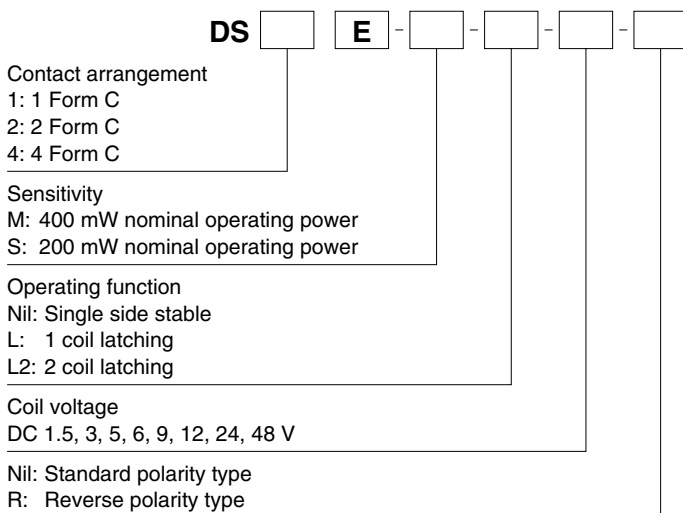

Note: 1 coil latching type are manufactured by lot upon receipt of order.
Reverse polarity types available (add suffix-R)

TYPES

1. Standard type

Contact arrangement	Nominal coil voltage	Single side stable type	2 coil latching type
		Part No.	Part No.
1 Form C	1.5V DC	DS1E-M-DC1.5V	DS1E-ML2-DC1.5V
	3V DC	DS1E-M-DC3V	DS1E-ML2-DC3V
	5V DC	DS1E-M-DC5V	DS1E-ML2-DC5V
	6V DC	DS1E-M-DC6V	DS1E-ML2-DC6V
	9V DC	DS1E-M-DC9V	DS1E-ML2-DC9V
	12V DC	DS1E-M-DC12V	DS1E-ML2-DC12V
	24V DC	DS1E-M-DC24V	DS1E-ML2-DC24V
2 Form C	48V DC	DS1E-M-DC48V	DS1E-ML2-DC48V
	1.5V DC	DS2E-M-DC1.5V	DS2E-ML2-DC1.5V
	3V DC	DS2E-M-DC3V	DS2E-ML2-DC3V
	5V DC	DS2E-M-DC5V	DS2E-ML2-DC5V
	6V DC	DS2E-M-DC6V	DS2E-ML2-DC6V
	9V DC	DS2E-M-DC9V	DS2E-ML2-DC9V
	12V DC	DS2E-M-DC12V	DS2E-ML2-DC12V
4 Form C	24V DC	DS2E-M-DC24V	DS2E-ML2-DC24V
	48V DC	DS2E-M-DC48V	DS2E-ML2-DC48V
	1.5V DC	DS4E-M-DC1.5V	DS4E-ML2-DC1.5V
	3V DC	DS4E-M-DC3V	DS4E-ML2-DC3V
	5V DC	DS4E-M-DC5V	DS4E-ML2-DC5V
	6V DC	DS4E-M-DC6V	DS4E-ML2-DC6V
	9V DC	DS4E-M-DC9V	DS4E-ML2-DC9V
4 Form C	12V DC	DS4E-M-DC12V	DS4E-ML2-DC12V
	24V DC	DS4E-M-DC24V	DS4E-ML2-DC24V
	48V DC	DS4E-M-DC48V	DS4E-ML2-DC48V

Standard packing: Tube: 50 pcs.; Case: 500 pcs.

2. High sensitivity type

Contact arrangement	Nominal coil voltage	Single side stable type	2 coil latching type
		Part No.	Part No.
1 Form C	1.5V DC	DS1E-S-DC1.5V	DS1E-SL2-DC1.5V
	3V DC	DS1E-S-DC3V	DS1E-SL2-DC3V
	5V DC	DS1E-S-DC5V	DS1E-SL2-DC5V
	6V DC	DS1E-S-DC6V	DS1E-SL2-DC6V
	9V DC	DS1E-S-DC9V	DS1E-SL2-DC9V
	12V DC	DS1E-S-DC12V	DS1E-SL2-DC12V
	24V DC	DS1E-S-DC24V	DS1E-SL2-DC24V
2 Form C	48V DC	DS1E-S-DC48V	DS1E-SL2-DC48V
	1.5V DC	DS2E-S-DC1.5V	DS2E-SL2-DC1.5V
	3V DC	DS2E-S-DC3V	DS2E-SL2-DC3V
	5V DC	DS2E-S-DC5V	DS2E-SL2-DC5V
	6V DC	DS2E-S-DC6V	DS2E-SL2-DC6V
	9V DC	DS2E-S-DC9V	DS2E-SL2-DC9V
	12V DC	DS2E-S-DC12V	DS2E-SL2-DC12V
4 Form C	24V DC	DS2E-S-DC24V	DS2E-SL2-DC24V
	48V DC	DS2E-S-DC48V	DS2E-SL2-DC48V
	1.5V DC	DS4E-S-DC1.5V	DS4E-SL2-DC1.5V
	3V DC	DS4E-S-DC3V	DS4E-SL2-DC3V
	5V DC	DS4E-S-DC5V	DS4E-SL2-DC5V
	6V DC	DS4E-S-DC6V	DS4E-SL2-DC6V
	9V DC	DS4E-S-DC9V	DS4E-SL2-DC9V
4 Form C	12V DC	DS4E-S-DC12V	DS4E-SL2-DC12V
	24V DC	DS4E-S-DC24V	DS4E-SL2-DC24V
	48V DC	DS4E-S-DC48V	DS4E-SL2-DC48V

Standard packing: Tube: 50 pcs.; Case: 500 pcs.

Notes: 1. 1 coil latching type are manufactured by lot upon receipt of order.

2. Reverse polarity types available (add suffix-R)

RATING

1. Coil data

1) Single side stable type

Type	Nominal coil voltage	Pick-up voltage (at 20°C 68°F)	Drop-out voltage (at 20°C 68°F)	Nominal operating current [$\pm 10\%$] (at 20°C 68°F)	Coil resistance [$\pm 10\%$] (at 20°C 68°F)	Nominal operating power	Max. allowable voltage (at 50°C 122°F)
Standard (M) type	1.5V DC	70%V or less of nominal voltage (Initial)	10%V or more of nominal voltage (Initial)	266.7mA	5.63Ω	400mW	1 Form C: 120%V of nominal voltage 2 Form C, 4 Form C: 150%V of nominal voltage
	3V DC			133.3mA	22.5Ω		
	5V DC			80.0mA	62.5Ω		
	6V DC			66.7mA	90Ω		
	9V DC			44.4mA	203Ω		
	12V DC			33.3mA	360Ω		
	24V DC			16.7mA	1,440Ω		
48V DC	8.3mA	5,760Ω					
High sensitivity (S) type	1.5V DC	1 Form C: 80%V or less of nominal voltage 2 Form C, 4 Form C: 70%V or less of nominal voltage (Initial)	10%V or more of nominal voltage (Initial)	133.3mA	11.3Ω	200mW	1 Form C: 160%V of nominal voltage 2 Form C, 4 Form C: 200%V of nominal voltage
	3V DC			66.7mA	45Ω		
	5V DC			40.0mA	125Ω		
	6V DC			33.3mA	180Ω		
	9V DC			22.2mA	405Ω		
	12V DC			16.7mA	720Ω		
	24V DC			8.3mA	2,880Ω		
48V DC	4.2mA	11,520Ω					

2) 2 coil latching type

Type	Nominal coil voltage	Set voltage (at 20°C 68°F)	Reset voltage (at 20°C 68°F)	Nominal operating current [$\pm 10\%$] (at 20°C 68°F)		Coil resistance [$\pm 10\%$] (at 20°C 68°F)		Nominal operating power		Max. allowable voltage (at 50°C 122°F)
				Set coil	Reset coil	Set coil	Reset coil	Set coil	Reset coil	
Standard (M) type	1.5V DC	70%V or less of nominal voltage (Initial)	70%V or less of nominal voltage (Initial)	240mA	240mA	6.25Ω	6.25Ω	360mW	360mW	1 Form C: 120%V of nominal voltage 2 Form C, 4 Form C: 150%V of nominal voltage
	3V DC			120mA	120mA	25Ω	25Ω			
	5V DC			72mA	72mA	69.4Ω	69.4Ω			
	6V DC			60mA	60mA	100Ω	100Ω			
	9V DC			40mA	40mA	225Ω	225Ω			
	12V DC			30mA	30mA	400Ω	400Ω			
	24V DC			15mA	15mA	1,600Ω	1,600Ω			
48V DC	7.5mA	7.5mA	6,400Ω	6,400Ω						
High sensitivity (S) type	1.5V DC	1 Form C: 80%V or less of nominal voltage 2 Form C, 4 Form C: 70%V or less of nominal voltage (Initial)	1 Form C: 80%V or less of nominal voltage 2 Form C, 4 Form C: 70%V or less of nominal voltage (Initial)	120mA	120mA	12.5Ω	12.5Ω	180mW	180mW	1 Form C: 160%V of nominal voltage 2 Form C, 4 Form C: 200%V of nominal voltage
	3V DC			60mA	60mA	50Ω	50Ω			
	5V DC			36mA	36mA	139Ω	139Ω			
	6V DC			30mA	30mA	200Ω	200Ω			
	9V DC			20mA	20mA	450Ω	450Ω			
	12V DC			15mA	15mA	800Ω	800Ω			
	24V DC			7.5mA	7.5mA	3,200Ω	3,200Ω			
48V DC	3.75mA	3.75mA	12,800Ω	12,800Ω						

2. Specifications

Characteristics	Item	Specifications		
		1 Form C	2 Form C	4 Form C
Contact	Arrangement	1 Form C	2 Form C	4 Form C
	Initial contact resistance, max.	Max. 50 mΩ (By voltage drop 6 V DC 1A)		
	Contact material	Ag+Au clad		
Rating	Nominal switching capacity (resistive load)	2 A 30 V DC		
	Max. switching power (resistive load)	60 W, 125 VA		
	Max. switching voltage	220 V DC, 250 V AC		
	Max. carrying current	3 A		
	Min. switching capacity (Reference value)*1	10μA 10m V DC		
	Nominal operating power	Single side stable (M type: 400 mW, S type: 200 mW); latching (M type: 360 mW, S type: 180 mW)		
Electrical characteristics	Insulation resistance (Initial)		Min. 100MΩ (at 500V DC) Measurement at same location as "Initial breakdown voltage" section.	
	Breakdown voltage (Initial)	Between open contacts	1,000 Vrms for 1min. (500 Vrms for 1min: 1 Form C high sensitivity type) (Detection current: 10mA.)	
		Between contact and coil	1,500 Vrms for 1min. (1,000 Vrms for 1min: 1 Form C high sensitivity type) (Detection current: 10mA.)	
	Temperature rise		Max. 65°C (By resistive method, nominal voltage applied to the coil, contact carrying current: 2A.)	
	Operate time [Set time] (at 20°C 68°F)		Max. 10 ms [10 ms] (Nominal voltage applied to the coil, excluding contact bounce time.)	
	Release time [Reset time] (at 20°C 68°F)		Max. 5 ms [10 ms] (Nominal voltage applied to the coil, excluding contact bounce time.) (without diode)	
Mechanical characteristics	Shock resistance	Functional*2	Min. 490 m/s ²	Min. 294 m/s ²
		Destructive	Min. 980 m/s ² (Half-wave pulse of sine wave: 6 ms.)	
	Vibration resistance	Functional	10 to 55 Hz at double amplitude of 3.3 mm (Detection time: 10μs.)	
		Destructive	10 to 55 Hz at double amplitude of 5 mm	
Expected life	Mechanical	Min. 10 ⁸ (10 ⁷ : 1 Form C latching type) (at 600 cpm)		
	Electrical	Min. 5×10 ⁵ rated load (at 60 cpm)		
Conditions	Conditions for operation, transport and storage*3		Ambient temperature: -40°C to +70°C -40°F to +158°F Humidity: 5 to 85% R.H. (Not freezing and condensing at low temperature)	
	Max. operating speed (at rated load)		60 cpm	
Unit weight		Approx. 3 g .11 oz	Approx. 4g .14oz	Approx. 7g .25oz

Notes: *1 This value can change due to the switching frequency, environmental conditions, and desired reliability level, therefore it is recommended to check this with the actual load.

(SX relays are available for low level load switching [10V DC, 10mA max. level])

*2 Half-wave pulse of sine wave: 11ms; detection time: 10μs

*3 Refer to 6. Conditions for operation, transport and storage mentioned in AMBIENT ENVIRONMENT.

REFERENCE DATA

1. Maximum switching capacity

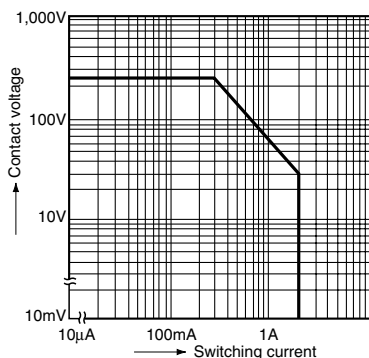

2. Life curve (Resistive load)

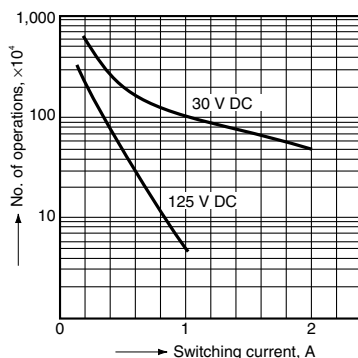

3. Contact reliability for AC loads

Tested sample: DS2E-M-DC24V 10 pcs.

Operating speed: 20 cpm.

Detection level: 200 mΩ

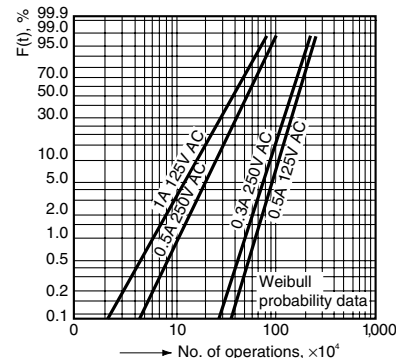

4-(1). Coil temperature rise
(2 Form C single side stable type)

Tested sample: DS2E-M-DC12V
Point measured: Inside the coil
Ambient temperature: 18° to 19°C 64° to 66°F

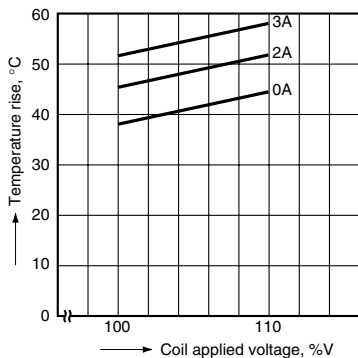

4-(2). Coil temperature rise
(4 Form C single side stable type)

Tested sample: DS4E-M-DC12V
Point measured: Inside the coil
Ambient temperature: 17° to 18°C 63° to 64°F

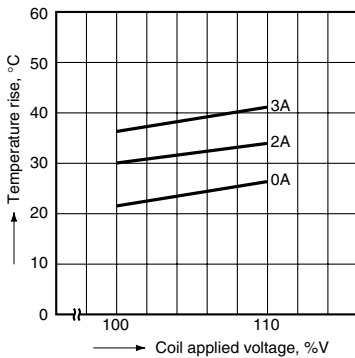

4-(3). Coil temperature rise
(2 Form C 2 coil latching type)

Tested sample: DS2E-ML2-DC12V
Point measured: Inside the coil
Ambient temperature: 20° to 21°C 68° to 70°F

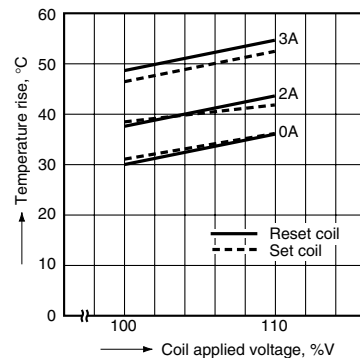

4-(4). Coil temperature rise
(4 Form C 2 coil latching type)

Tested sample: DS4E-ML2-DC12V
Point measured: Inside the coil
Ambient temperature: 20°C 68°F

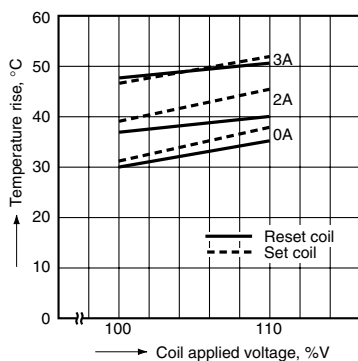

5. Operate and release time characteristics
(2 Form C single side stable type)

Test condition: Without diode connected to coil in parallel

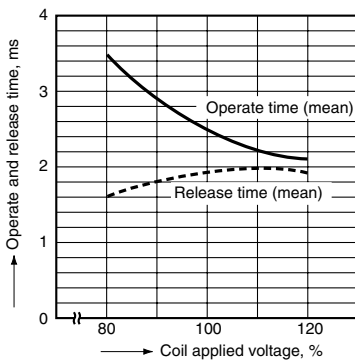

6-(1). Influence of adjacent mounting
(1 Form C)

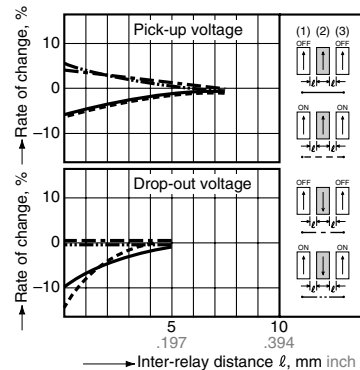

6-(2). Influence of adjacent mounting
(2 Form C)

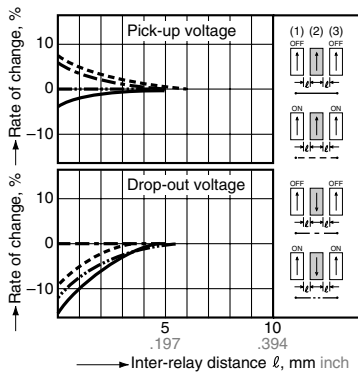

6-(3). Influence of adjacent mounting
(4 Form C)

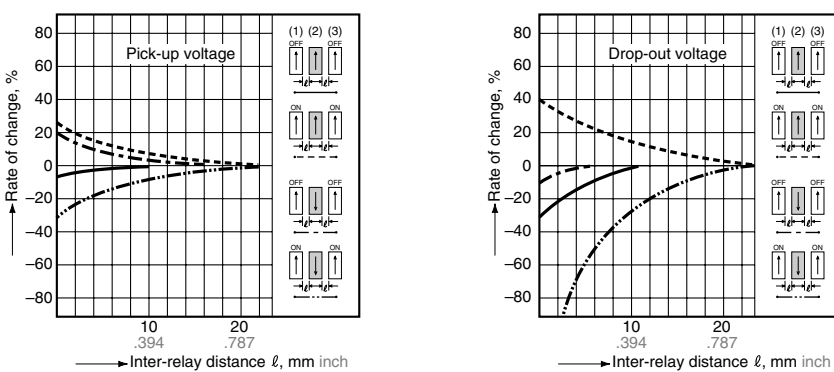

DS

DIMENSIONS (Unit: mm inch)

DS (1 Form C)

Single side stable, 2 coil latching

External dimensions

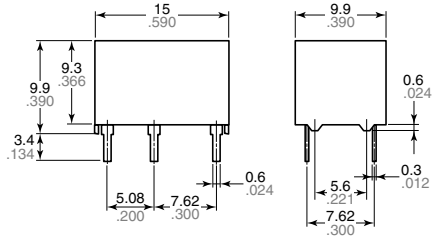

General tolerance: $\pm 0.3 \pm .012$

PC board pattern (Bottom view)
Single side stable 2 coil latching

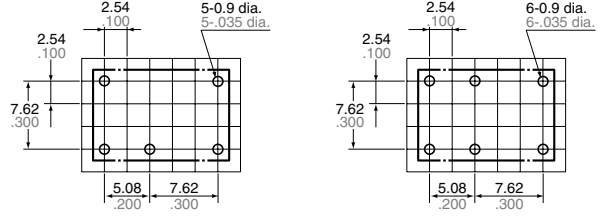

Schematic (Bottom view)

Single side stable

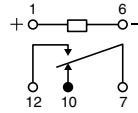

(Deenergized condition)

2 coil latching

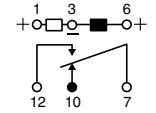

(Reset condition)

Tolerance: $\pm 0.1 \pm .004$

Note: External dimensions of 1 coil latching types are same as single side stable type.

DS (2 Form C)

Single side stable

External dimensions

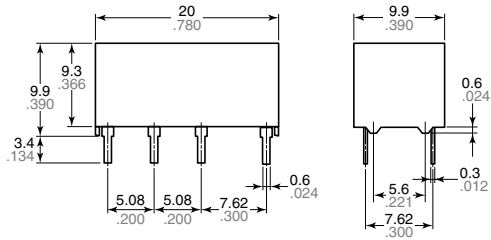

General tolerance: $\pm 0.3 \pm .012$

PC board pattern (Bottom view)

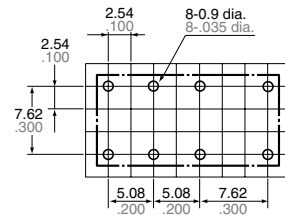

Schematic (Bottom view)

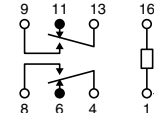

(Deenergized condition)

Tolerance: $\pm 0.1 \pm .004$

Note: External dimensions of 1 coil latching types are same as single side stable type.

DS (2 Form C)

2 coil latching

External dimensions

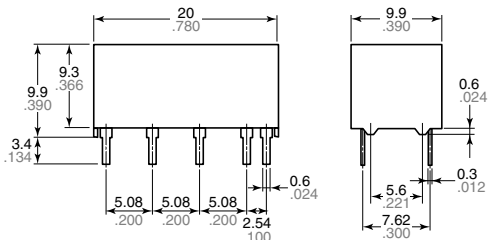

General tolerance: $\pm 0.3 \pm .012$

PC board pattern (Bottom view)

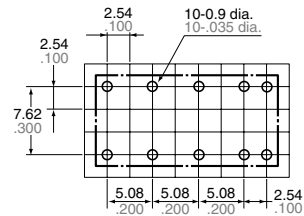

Schematic (Bottom view)

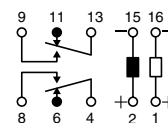

(Reset condition)

Tolerance: $\pm 0.1 \pm .004$

DS (4 Form C)

Single side stable

External dimensions

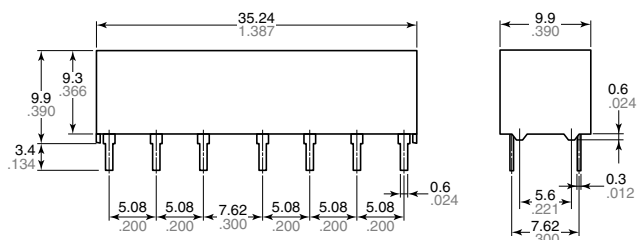

General tolerance: $\pm 0.3 \pm 0.12$

PC board pattern (Bottom view)

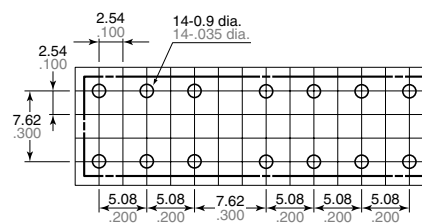

Schematic (Bottom view)

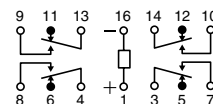

(Deenergized condition)

Note: External dimensions of 1 coil latching types are same as single side stable type.

Tolerance: $\pm 0.1 \pm 0.004$

DS (4 Form C)

2 coil latching

External dimensions

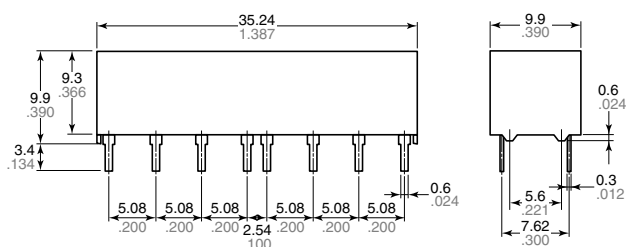

General tolerance: $\pm 0.3 \pm 0.12$

PC board pattern (Bottom view)

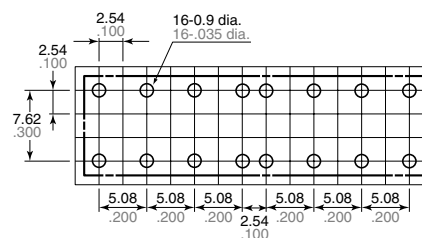

Schematic (Bottom view)

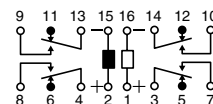

(Reset condition)

Tolerance: $\pm 0.1 \pm 0.004$

NOTES

1. Coil connection

When connecting coils, refer to the wiring diagram to prevent mis-operation or malfunction.



2. External magnetic field

Since DS relays are highly sensitive polarized relays, their characteristics will be affected by a strong external magnetic field. Avoid using the relay under that condition.

For Cautions for Use, see Relay Technical Information.

Looking for pricing, stock, or lifecycle information?

Click below to explore more details on WIN SOURCE:

-  [View DS4E-SL2-DC5V on WIN SOURCE](#)
-  [Panasonic Information](#)

Optimize Your Supply Chain with WIN SOURCE Solutions

-  Global Sourcing Solution
-  Obsolete Management
-  Cost Control Management
-  Shortage Management
-  Alternative Solution
-  Excess Inventory Management