



**THE DATASHEET OF
TPS61040EVM-001**



TPS61040EVM-001 Evaluation Module

User's Guide

IMPORTANT NOTICE

Texas Instruments Incorporated and its subsidiaries (TI) reserve the right to make corrections, modifications, enhancements, improvements, and other changes to its products and services at any time and to discontinue any product or service without notice. Customers should obtain the latest relevant information before placing orders and should verify that such information is current and complete. All products are sold subject to TI's terms and conditions of sale supplied at the time of order acknowledgment.

TI warrants performance of its hardware products to the specifications applicable at the time of sale in accordance with TI's standard warranty. Testing and other quality control techniques are used to the extent TI deems necessary to support this warranty. Except where mandated by government requirements, testing of all parameters of each product is not necessarily performed.

TI assumes no liability for applications assistance or customer product design. Customers are responsible for their products and applications using TI components. To minimize the risks associated with customer products and applications, customers should provide adequate design and operating safeguards.

TI does not warrant or represent that any license, either express or implied, is granted under any TI patent right, copyright, mask work right, or other TI intellectual property right relating to any combination, machine, or process in which TI products or services are used. Information published by TI regarding third-party products or services does not constitute a license from TI to use such products or services or a warranty or endorsement thereof. Use of such information may require a license from a third party under the patents or other intellectual property of the third party, or a license from TI under the patents or other intellectual property of TI.

Reproduction of information in TI data books or data sheets is permissible only if reproduction is without alteration and is accompanied by all associated warranties, conditions, limitations, and notices. Reproduction of this information with alteration is an unfair and deceptive business practice. TI is not responsible or liable for such altered documentation.

Resale of TI products or services with statements different from or beyond the parameters stated by TI for that product or service voids all express and any implied warranties for the associated TI product or service and is an unfair and deceptive business practice. TI is not responsible or liable for any such statements.

Mailing Address:

Texas Instruments
Post Office Box 655303
Dallas, Texas 75265

EVM IMPORTANT NOTICE

Texas Instruments (TI) provides the enclosed product(s) under the following conditions:

This evaluation kit being sold by TI is intended for use for **ENGINEERING DEVELOPMENT OR EVALUATION PURPOSES ONLY** and is not considered by TI to be fit for commercial use. As such, the goods being provided may not be complete in terms of required design-, marketing-, and/or manufacturing-related protective considerations, including product safety measures typically found in the end product incorporating the goods. As a prototype, this product does not fall within the scope of the European Union directive on electromagnetic compatibility and therefore may not meet the technical requirements of the directive.

Should this evaluation kit not meet the specifications indicated in the EVM User's Guide, the kit may be returned within 30 days from the date of delivery for a full refund. **THE FOREGOING WARRANTY IS THE EXCLUSIVE WARRANTY MADE BY SELLER TO BUYER AND IS IN LIEU OF ALL OTHER WARRANTIES, EXPRESSED, IMPLIED, OR STATUTORY, INCLUDING ANY WARRANTY OF MERCHANTABILITY OR FITNESS FOR ANY PARTICULAR PURPOSE.**

The user assumes all responsibility and liability for proper and safe handling of the goods. Further, the user indemnifies TI from all claims arising from the handling or use of the goods. Please be aware that the products received may not be regulatory compliant or agency certified (FCC, UL, CE, etc.). Due to the open construction of the product, it is the user's responsibility to take any and all appropriate precautions with regard to electrostatic discharge.

EXCEPT TO THE EXTENT OF THE INDEMNITY SET FORTH ABOVE, NEITHER PARTY SHALL BE LIABLE TO THE OTHER FOR ANY INDIRECT, SPECIAL, INCIDENTAL, OR CONSEQUENTIAL DAMAGES.

TI currently deals with a variety of customers for products, and therefore our arrangement with the user **is not exclusive.**

TI assumes **no liability for applications assistance, customer product design, software performance, or infringement of patents or services described herein.**

Please read the EVM User's Guide and, specifically, the EVM Warnings and Restrictions notice in the EVM User's Guide prior to handling the product. This notice contains important safety information about temperatures and voltages. For further safety concerns, please contact the TI application engineer.

Persons handling the product must have electronics training and observe good laboratory practice standards.

No license is granted under any patent right or other intellectual property right of TI covering or relating to any machine, process, or combination in which such TI products or services might be or are used.

Mailing Address:

Texas Instruments
Post Office Box 655303
Dallas, Texas 75265

EVM WARNINGS AND RESTRICTIONS

It is important to operate this EVM within the supply voltage range of 1.8 V to 6 V.

Exceeding the specified supply range may cause unexpected operation and/or irreversible damage to the EVM. If there are questions concerning the supply range, please contact a TI field representative prior to connecting the input power.

Applying loads outside of the specified output range may result in unintended operation and/or possible permanent damage to the EVM. Please consult the EVM User's Guide prior to connecting any load to the EVM output. If there is uncertainty as to the load specification, please contact a TI field representative.

During normal operation, some circuit components may have case temperatures greater than 125°C. The EVM is designed to operate properly with certain components above 125°C as long as the input and output ranges are maintained. These components include but are not limited to linear regulators, switching transistors, pass transistors, and current sense resistors. These types of devices can be identified using the EVM schematic located in the EVM User's Guide. When placing measurement probes near these devices during operation, please be aware that these devices may be very warm to the touch.

Mailing Address:

Texas Instruments
Post Office Box 655303
Dallas, Texas 75265

Preface

About This Manual

This users guide describes the characteristics, operation, and use of the TPS61040EVM LCD bias supply evaluation module (EVM). This EVM is a Texas Instruments high-efficiency boost converter that is configured to generate 18 V at 20 mA, for LCD bias supply, from a single cell Li-Ion battery. The users guide includes a schematic diagram, bill of materials (BOM), and test data.

How to Use This Manual

This document contains the following chapters:

- Chapter 1—Introduction
- Chapter 2—Setup and Test Results
- Chapter 3—Board Layout
- Chapter 4—Schematic and Bill of Materials

Related Documentation From Texas Instruments

- TPS601040/41*** data sheet (literature number SLVS413).

FCC Warning

This equipment is intended for use in a laboratory test environment only. It generates, uses, and can radiate radio frequency energy and has not been tested for compliance with the limits of computing devices pursuant to subpart J of part 15 of FCC rules, which are designed to provide reasonable protection against radio frequency interference. Operation of this equipment in other environments may cause interference with radio communications, in which case the user at his own expense will be required to take whatever measures may be required to correct this interference.



Contents

1	Introduction	1-1
1.1	Background	1-2
1.2	Performance Specification Summary	1-2
2	Setup and Test Results	2-1
2.1	Input/Output Connections	2-2
2.2	EVM Operation	2-2
2.3	Start-Up	2-2
2.4	Output Voltage Ripple	2-3
2.5	Switching Waveforms	2-4
2.6	Input Voltage Ripple	2-4
2.7	Efficiency	2-5
2.8	Output Adjust	2-6
	2.8.1 Variable Resistor Output Voltage Adjust	2-6
	2.8.2 Variable Control Voltage Output Voltage Adjust	2-6
3	Board Layout	3-1
3.1	Layout	3-1
4	Schematic and Bill of Materials	4-1
4.1	Schematic	4-2
4.2	Bill of Materials	4-2

Figures

2-1	Start-Up Waveforms	2-3
2-2	Output Ripple	2-3
2-3	SW Waveform	2-4
2-4	Input Ripple Voltage	2-5
2-5	Typical Efficiency	2-5
3-1	Assembly Layer	3-1
3-2	Top Layer Routing	3-2
3-3	Bottom Layer Routing	3-2
4-1	TPS61040EVM-001 Schematic	4-2

Tables

1-1	TPS61040 Performance Specification Summary	1-2
2-1	Input/Output Connections	2-2
4-1	TPS61040EVM-001 Bill of Materials	4-2

Introduction

This chapter contains background information for the TPS61040 and support documentation for the TPS61040EVM-001 evaluation module.

Topic	Page
1.1 Background	1-2
1.2 Performance Specification Summary	1-2

1.1 Background

This TPS61040EVM uses the TPS61040 boost converter to generate an 18-V output from a single cell Li-Ion battery (3 V to 4.2 V). This EVM operates over an input voltage range of 1.8 V to 6 V, but has been optimized over the 3-V to 5-V input range. Operation with an input voltage down to 1.8 V is possible, depending on the output current and voltage settings. The EVM includes an adjust pin that allows the user to adjust the LCD bias with either a variable resistance or an analog voltage.

The output voltage of the TPS61040EVM can be adjusted up to 28 V by modifying the resistor values used in resistor divider R1 & R2. The EVM can also be configured for higher or lower output currents. For lower currents, the TPS61040 may be replaced by the pin for pin compatible TPS61041. More information about output voltage adjustment and current ratings of TPS61040/41 devices can be found in the data sheet *Literature Number SLVS413*.

1.2 Performance Specification Summary

Table 1–1 provides a summary of the TPS61040EVM–001 performance specifications. All specifications are given for an ambient temperature of 25°C. The EVM may be modified to operate over different input and output currents and voltages, per the TPS61040 data sheet specifications.

Table 1–1. TPS61040 Performance Specification Summary

Specification	Test Conditions	Min	Typ	Max	Unit
Input voltage range	$I_O = 20 \text{ mA}$	3		5	V
Output voltage			18		V
Output current		5		20	mA
Output voltage ripple			100		mV
Efficiency			88.5%		

Setup and Test Results

This chapter describes how to properly connect, setup, and use the TPS61040EVM-001. This chapter also presents the test results for this EVM.

Topic	Page
2.1 Input/Output Connections	2-2
2.2 EVM Operation	2-2
2.3 Start-Up	2-2
2.4 Output Voltage Ripple	2-3
2.5 Switching Waveforms	2-4
2.6 Input Voltage Ripple	2-4
2.7 Efficiency	2-5
2.8 Output Adjust	2-6

2.1 Input/Output Connections

The TPS61040EVM-001 PWB has several connections, which are described in Table 2-1.

Table 2-1. Input/Output Connections

Reference Designator	Name	Description
J1	V _{in}	This is the positive connection to the input power supply. The leads to the input supply should be twisted and kept as short as possible.
J2	GND	This is the return connection to the input power supply.
J3	Adjust	A variable resistor may be connected between J3-1 and J3-2 to vary the output voltage of the EVM. J3-1 has a square pad and is connected directly to the FB pin of the TPS61040. J3-2 has a round pad and is connected directly to ground. The output voltage may also be adjusted by connecting an analog voltage through a resistor to J3-1.
J4	GND	This is the return pin for the load.
J5	V _{out}	This is the positive connection for the load.
JP1	Enable	Use this connector to enable and disable the power supply. Connect a jumper between the On pin and the center pin to enable the supply, and connect a jumper between the Off pin and the center pin to disable the supply. When the EN pin of the TPS61040 is left open, its state is undetermined. The jumper must either be connected to On (V _{in}) or to Off (GND) for the EVM to operate correctly.

2.2 EVM Operation

Connect an input supply and a load to the appropriate connectors provided on the EVM. The absolute maximum input voltage is 7 V. The TPS61040 is designed to operate with a maximum 6-V input voltage. Move the *adjust* jumper from the **Off** position to the **On** position to enable the supply.

Placing a variable resistor across the adjust pins of the EVM allows the user to vary the output voltage. Specific design equations may be found in the TPS61040 data sheet.

2.3 Start-Up

Figure 2-1 shows the startup voltage and current waveforms of the EVM. When the EVM is enabled, the TPS61040 goes through its programmed three-stage soft-start sequence to reduce inrush current at turn on.

Figure 2–1. Start-Up Waveforms

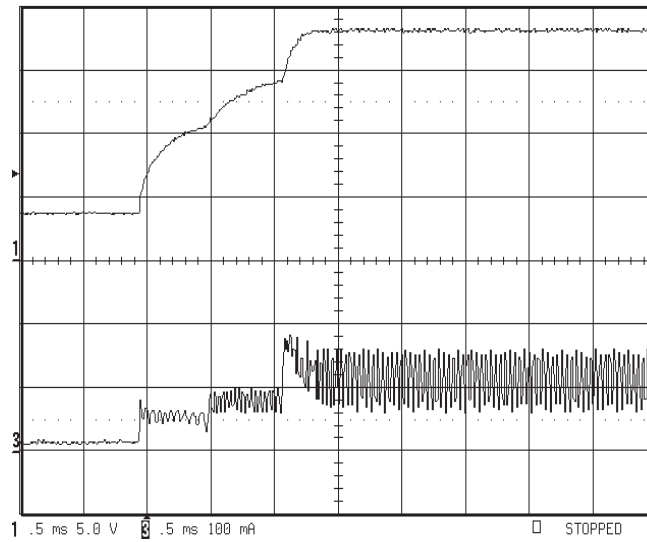

2.4 Output Voltage Ripple

Figure 2–2 shows the output voltage ripple with $I_O = 20$ mA. The top trace shows the ripple with 3.6-V input, and the bottom trace shows the ripple with a 4.2-V input. The difference in switching frequency between the two traces is expected and is explained in the data sheet.

Figure 2–2. Output Ripple

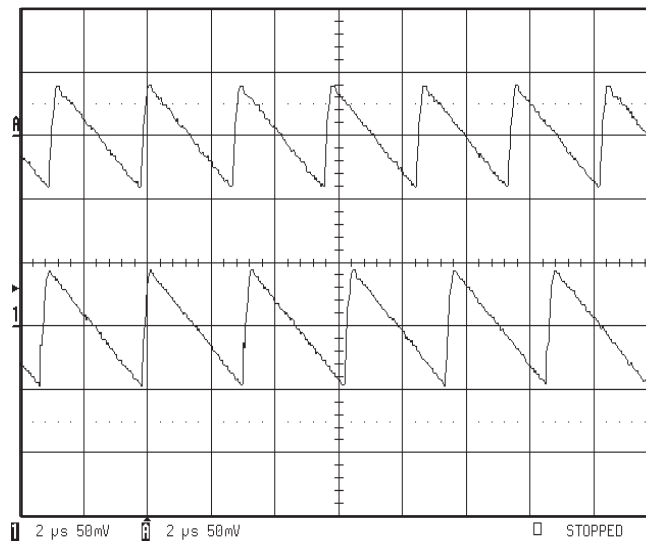

2.5 Switching Waveforms

Figure 2–3 shows the switching waveform at the SW pin of the TPS61040. When the internal FET turns on, the voltage at the SW pin is pulled to ground until the inductor current reaches 450 mA. When the inductor current reaches 450 mA, the FET turns off and the voltage at the SW pin rises to the output voltage plus the forward voltage drop of the diode. During this time, the inductor transfers its stored energy to the load and the output capacitor. When the inductor current decays to zero, the SW node rings at a frequency determined by the output inductor and the drain capacitance of the internal FET. This ringing is indicative of a discontinuous boost power supply topology.

Figure 2–3. SW Waveform

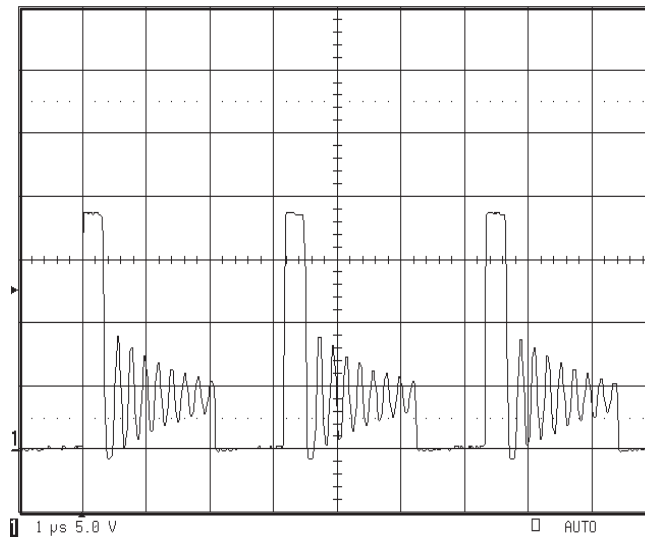

2.6 Input Voltage Ripple

Figure 2–4 shows the input voltage and current ripple of the supply with $V_{in} = 3.6$ V and $I_O = 20$ mA. The input capacitance of the TPS61040 and the impedance of the input voltage supply largely determine the input voltage and current ripple. Increasing the input capacitance or lowering the source impedance reduces the input voltage and current ripple.

Figure 2–4. Input Ripple Voltage

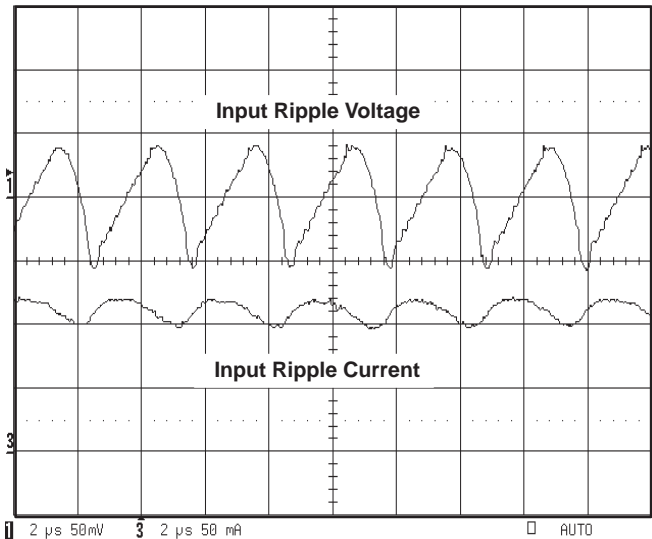

2.7 Efficiency

Figure 2–5 shows the measured efficiency of the TPS61040.

Figure 2–5. Typical Efficiency

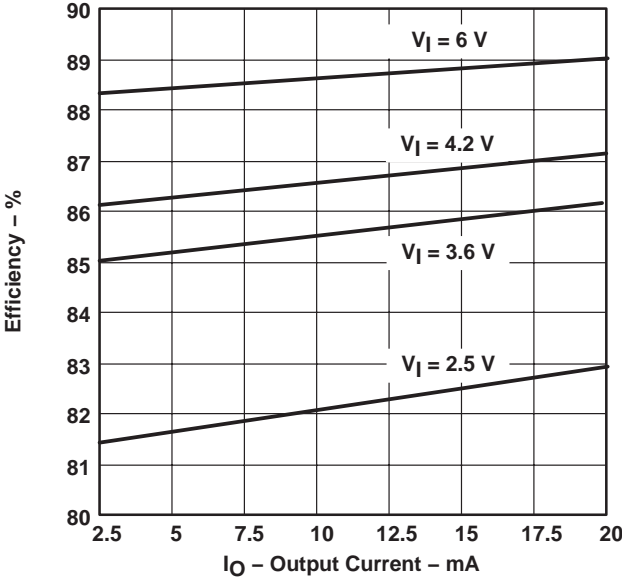

2.8 Output Adjust

The TPS61040EMV-001 provides two methods of output voltage adjustment for LCD contrast control. The first method of output voltage adjustment is accomplished with a variable resistor, while the second method is accomplished using a variable control voltage.

2.8.1 Variable Resistor Output Voltage Adjust

This method is accomplished by removing R2 on the EVM and then placing a variable resistor between J3-1 and ground. The equations provided below calculate the range of the variable resistor where:

- $R_{\text{(adjust),min}}$ = minimum value for R2
- $R_{\text{(adjust),max}}$ = maximum value for R2
- R1 = value for R1
- $V_{O,\text{max}}$ = maximum desired output voltage
- $V_{O,\text{min}}$ = minimum desired output voltage

$$R_{\text{adjust,min}} = 1.233 \text{ V} \times \frac{R1}{(V_{O,\text{max}} - 1.233 \text{ V})} \quad (1)$$

$$R_{\text{adjust,max}} = 1.233 \text{ V} \times \frac{R1}{(V_{O,\text{min}} - 1.233 \text{ V})} \quad (2)$$

For example, if $V_{O,\text{max}} = 19 \text{ V}$, $V_{O,\text{min}} = 17 \text{ V}$, and $R1 = 2.21 \text{ M}\Omega$, then $R_{\text{(adjust),min}} = 153.4 \text{ k}\Omega$, and $R_{\text{(adjust),max}} = 172.8 \text{ k}\Omega$. This scenario is best implemented using a 154-k Ω resistor in series with a 20-k Ω potentiometer.

2.8.2 Variable Control Voltage Output Voltage Adjust

This method is accomplished by connecting a variable control voltage through a resistor, $R_{\text{(adjust)}}$, to J3-1. The equations provided below calculate R2 and $R_{\text{(adjust)}}$ where:

$$R2 = 1.233 \text{ V} \times R1 \times \frac{(V_{\text{adjust,max}} - V_{\text{adjust,min}})}{\left[1.233 \text{ V}(V_{O,\text{min}} - V_{O,\text{max}} + V_{\text{adjust,min}} - V_{\text{adjust,max}}) - V_{\text{adjust,min}} \times V_{O,\text{min}} + V_{\text{adjust,max}} \times V_{O,\text{max}} \right]} \quad (3)$$

$$R_{\text{adjust}} = R2 \times R1 \times \frac{(V_{\text{adjust,max}} - 1.233 \text{ V})}{\left[1.233 \text{ V}(R2 + R1) - V_{O,\text{min}} \times R2 \right]} \quad (4)$$

For example, if $V_{O,\text{max}} = 19 \text{ V}$, $V_{O,\text{min}} = 17 \text{ V}$, $V_{\text{(adjust),min}} = 0 \text{ V}$, $V_{\text{(adjust),max}} = 3.3 \text{ V}$, and $R1 = 1 \text{ M}\Omega$, then $R2 = 72.4 \text{ k}\Omega$, and $R_{\text{(adjust)}} = 1.65 \text{ M}\Omega$. When $V_{\text{(adjust)}} = 0 \text{ V}$ then $V_O = 19 \text{ V}$. When $V_{\text{(adjust)}} = 3.3 \text{ V}$ then $V_O = 17 \text{ V}$.

Board Layout

This chapter provides the TPS61040EVM-001 board layout and illustrations.

Topic	Page
3.1 Layout	3-1

3.1 Layout

Board layout is critical for all switch mode power supplies. Figures 3-1, 3-2 and 3-3 show the board layout for the TPS61040EVM-001 PWB. The nodes with high-switching frequency are short and isolated from the noise-sensitive feedback circuitry. Careful attention has been given to the routing of high-frequency current loops. Refer to the data sheet for specific layout guidelines.

Figure 3-1. Assembly Layer

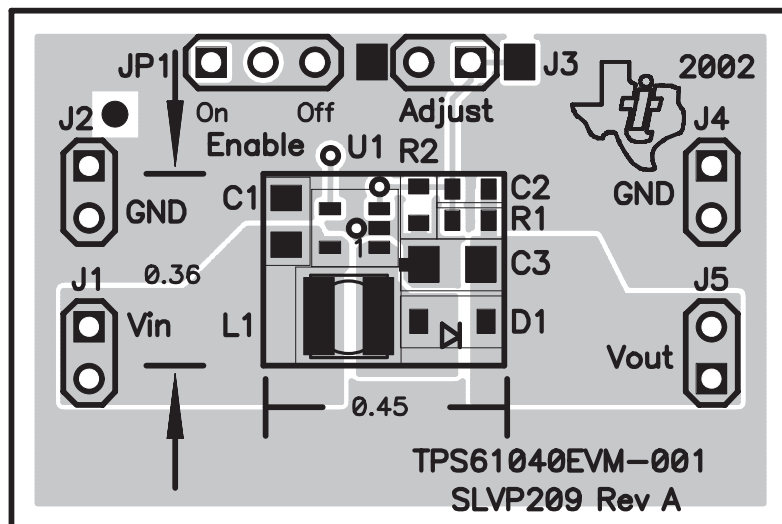

Figure 3–2. Top Layer Routing

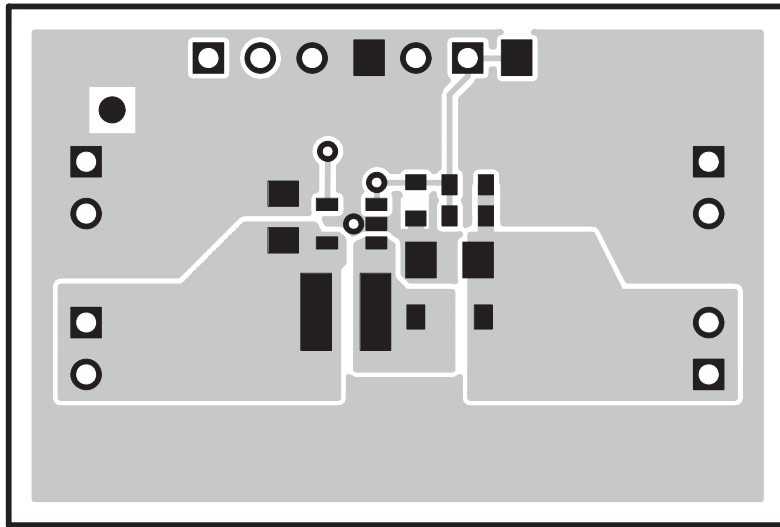
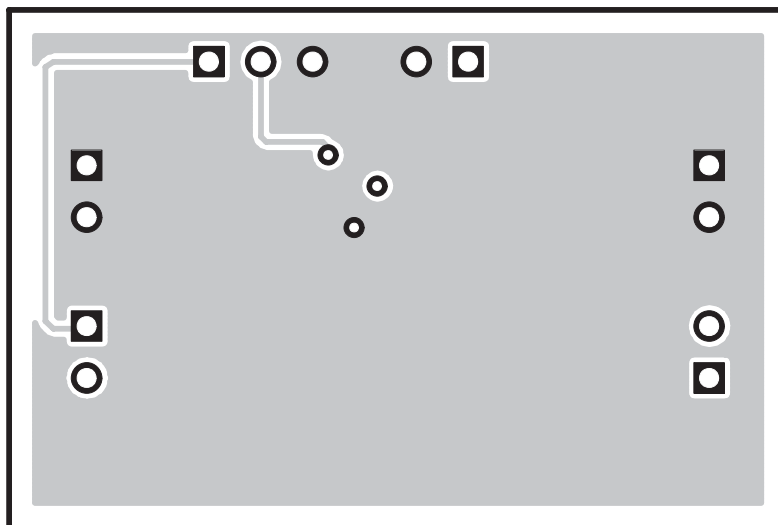

Figure 3–3. Bottom Layer Routing



Schematic and Bill of Materials

This chapter provides the TPS61040EVM-001 schematic and bill of materials.

Topic	Page
4.1 Schematic	4-2
4.2 Bill of Material	4-2

4.1 Schematic

Figure 4–1. TPS61040EVM–001 Schematic

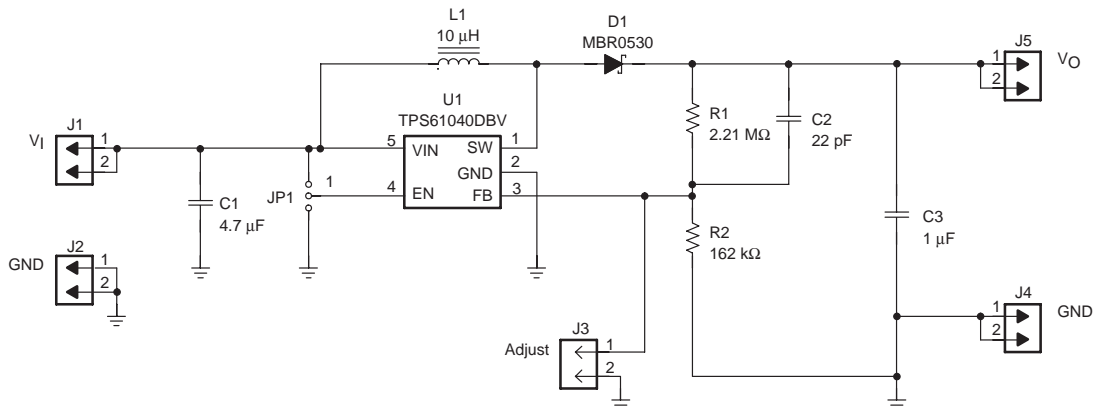

4.2 Bill of Materials

Table 4–1. TPS61040EVM–001 Bill of Materials

Reference	Description	Size	Qty.	MFG	Part #
C1	Capacitor, ceramic, 4.7 µF, 6.3 V, X5R, 15%	0805	1	Murata	GRM21B60J475KA11
C2	Capacitor, ceramic, 22 pF, 50 V, C0G, 5%	0603	1	Murata	GRM1885C1H220JZ01
C3	Capacitor, ceramic, 1 µF, 25 V, X7R, 10%	1206	1	Murata	GRM31MR7E105KC01
D1	Diode, Schottky 0.5 A 30 V	SOD–123	1	On Semi	MBR0530T1
J1 – J5	Header, 2-pin, 100-mil spacing (36-pin strip)	0.1 x 2"	5	Sullins	PTC36SAAN
JP1	Header, 3-pin, 100-mil spacing (36-pin strip)	0.1 x 3"	1	Sullins	PTC36SAAN
L1	Inductor, SMT, 10 µH, 0.76 A, 0.23 Ω	0.15 x 0.162	1	Sumida	CR32–100
R1	Resistor, chip, 2.21 MΩ, 1/16 W, 1%	0603	1	Standard	Standard
R2	Resistor, chip, 162 kΩ, 1/16 W, 1%	0603	1	Standard	Standard
U1	IC, high efficiency boost converter	SOT23–5 (DBV)	1	TI	TPS61040DBV
	PCB, 1.5' x 1" x 0.062"		1	Any	SLVP209
	Shunts, 100-mil, black	0.1 mm	1	3M	929950-00

Looking for pricing, stock, or lifecycle information?

Click below to explore more details on WIN SOURCE:

 [View TPS61040EVM-001](#) on WIN SOURCE

 [Texas Instruments](#) Information

Optimize Your Supply Chain with WIN SOURCE Solutions

-  Global Sourcing Solution
-  Obsolete Management
-  Cost Control Management
-  Shortage Management
-  Alternative Solution
-  Excess Inventory Management