



**THE DATASHEET OF
DC2810A**



LTM4673 Quad Output μ Module Regulator with Digital Power System Management

DESCRIPTION

Demonstration circuit 2810A features the [LTM[®]4673](#): the wide input and output voltage range, high efficiency and power density, quad output DC/DC step-down μ Module[®] regulator with Digital Interface for control and monitoring. The DC2810A default input voltage range is 4.5V to 15V. However, if V_{IN} is lower than 4.5V, minor modification to certain existing onboard components is required. Please refer to Step 8: Operation at $V_{IN} \leq 4.5V$ in Quick Start Procedure section. The factory default output voltages are $V_{OUT0} = 1V$, $V_{OUT3} = 0.9V$ at 12A per channel; $V_{OUT1} = 1.2V$, $V_{OUT2} = 1.8V$ at 5A per channel. The DC2810A output voltages can be adjusted from 0.6V up to 3.3V for channel 0 and channel 3 and from 0.6V to 5.5V for channel 1 and channel 2. The default switching frequencies are 600kHz for channel 0 and channel 3 and 1MHz for channel 1 and channel 2. Forced airflow and heatsink might also be used to further optimize the output power when all output rails are on and fully loaded. Programming the output voltages to values greater than 1.8V, may require derating output current based on thermal derating curves provided in the data sheet of the

LTM4673. The DC2810A comes with PMBus interface and digital power system management functions. An onboard 12-pin connector is available for users to connect the dongle [DC1613A](#) to the DC2810A and provides an easy way to communicate and program the part using LTpowerPlay[®] software development tool. LTpowerPlay software and I²C/PMBus/SMBus Dongle DC1613A allows users to monitor real time telemetry of input and output voltages, input and output current, internal IC die temperatures, and fault logs.

The LTM4673 is available in a thermally enhanced, low profile, 361-Lead (16mm \times 16mm \times 4.72mm) BGA package. It is recommended to read the data sheet and demo manual of LTM4673 prior to use or making any hardware changes to DC2810A.

LTpowerPlay software can be downloaded [here](#). The USB to PMBus Controller Dongle DC1613A for use with LTpowerPlay is available [here](#).

[Design files for this circuit board are available.](#)

All registered trademarks and trademarks are the property of their respective owners.

BOARD PHOTO Part marking is either ink mark or laser mark

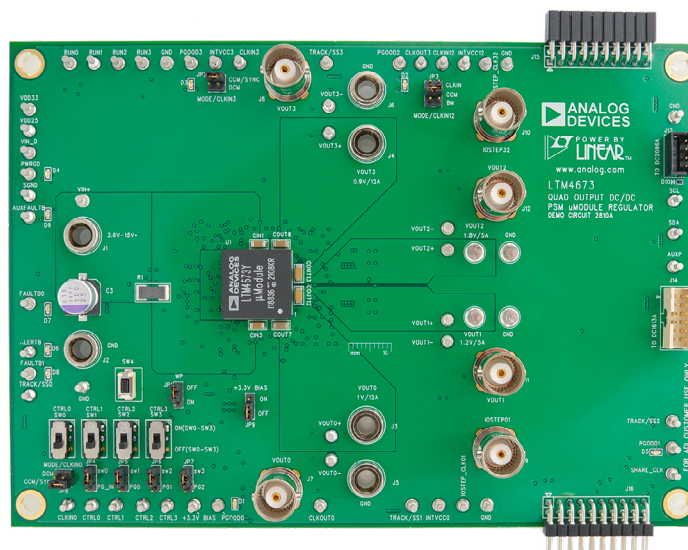

DEMO MANUAL DC2810A

PERFORMANCE SUMMARY Specifications are at $T_A = 25^\circ\text{C}$

PARAMETER	CONDITIONS	CHANNEL	MIN	TYP	MAX	UNITS
4-Phase Quad Output						
Input Voltage Range			4.5*	12	16	V
Demo Board Default Output Voltages	$V_{IN} = 4.5\text{V to }15\text{V}$; DAC Soft-Connect $I_{LOAD} = 0\text{A to }12\text{A}$ $I_{LOAD} = 0\text{A to }5\text{A}$ $I_{LOAD} = 0\text{A to }5\text{A}$ $I_{LOAD} = 0\text{A to }12\text{A}$	V_{OUT0} V_{OUT1} V_{OUT2} V_{OUT3}		1.0 1.2 1.8 0.9		V V V V
Default Switching Frequency	Factory Default Switching Frequency	V_{OUT0}, V_{OUT3} V_{OUT1}, V_{OUT2}		600 1000		kHz kHz
Maximum Continuous Output Current I_{OUT} per Channel	$V_{IN} = 4.5\text{V to }15\text{V}$ $V_{OUT0} = 1\text{V}$; $f_{SW} = 600\text{kHz}$ $V_{OUT1} = 1.2\text{V}$; $f_{SW} = 1000\text{kHz}$ $V_{OUT2} = 1.8\text{V}$; $f_{SW} = 1000\text{kHz}$ $V_{OUT3} = 0.9\text{V}$; $f_{SW} = 600\text{kHz}$	I_{OUT0} I_{OUT1} I_{OUT2} I_{OUT3}		12 5 5 12		A A A A
Efficiency	$V_{IN} = 4.5\text{V}$; CCM $V_{OUT0} = 1\text{V}$; $f_{SW} = 600\text{kHz}$; 12A Load $V_{OUT1} = 1.2\text{V}$; $f_{SW} = 1000\text{kHz}$; 5A Load $V_{OUT2} = 1.8\text{V}$; $f_{SW} = 1000\text{kHz}$; 5A Load $V_{OUT3} = 0.9\text{V}$; $f_{SW} = 600\text{kHz}$; 12A Load	CH0 CH1 CH2 CH3		86.3 81.4 86.3 85.3		% % % %
Efficiency	$V_{IN} = 12\text{V}$; CCM $V_{OUT0} = 1\text{V}$; $f_{SW} = 600\text{kHz}$; 12A Load $V_{OUT1} = 1.2\text{V}$; $f_{SW} = 1000\text{kHz}$; 5A Load $V_{OUT2} = 1.8\text{V}$; $f_{SW} = 1000\text{kHz}$; 5A Load $V_{OUT3} = 0.9\text{V}$; $f_{SW} = 600\text{kHz}$; 12A Load	CH0 CH1 CH2 CH3		84.6 79.5 85 82.9		% % % %

*See Step 8: Operation at $V_{IN} \leq 4.5\text{V}$ in Quick Start Procedure section for more information.

QUICK START PROCEDURE

Demonstration circuit 2810A is easy to setup to evaluate the performance of the LTM4673. Please refer to Figure 1 for proper measurement equipment setup and follow the test procedures below:

1. With power off, connect the input power supply between VIN (J1) and GND (J2).
2. Connect the first load between VOUT0 (J3) and GND (J5) for channel 0, connect the second load between VOUT1 (E16) and GND (E18) for channel 1, connect the third load between VOUT2 (E17) and GND (E19) for channel 2, connect the fourth load between VOUT3 (J4) and GND (J6) for channel 3. Preset all the loads to 0A.
3. Connect the DMM between the input test points: VIN+ (E1) and VIN- (E2) to monitor the input voltage. Connect DMMs between VOUT0+ (E4) and VOUT0 (E7), VOUT1+ (E44) and VOUT1- (E45), VOUT2+ (E46) and VOUT2- (E47), VOUT3+ (E5) and VOUT3- (E8), to monitor corresponding DC output voltages of channel 0, channel 1, channel 2 and channel 3.
4. Prior to powering up the DC2810A, check the default position of the jumpers and switches. Make sure the CONTROL switches are set in the "OFF" position before the next step. Refer to Table 1.

QUICK START PROCEDURE

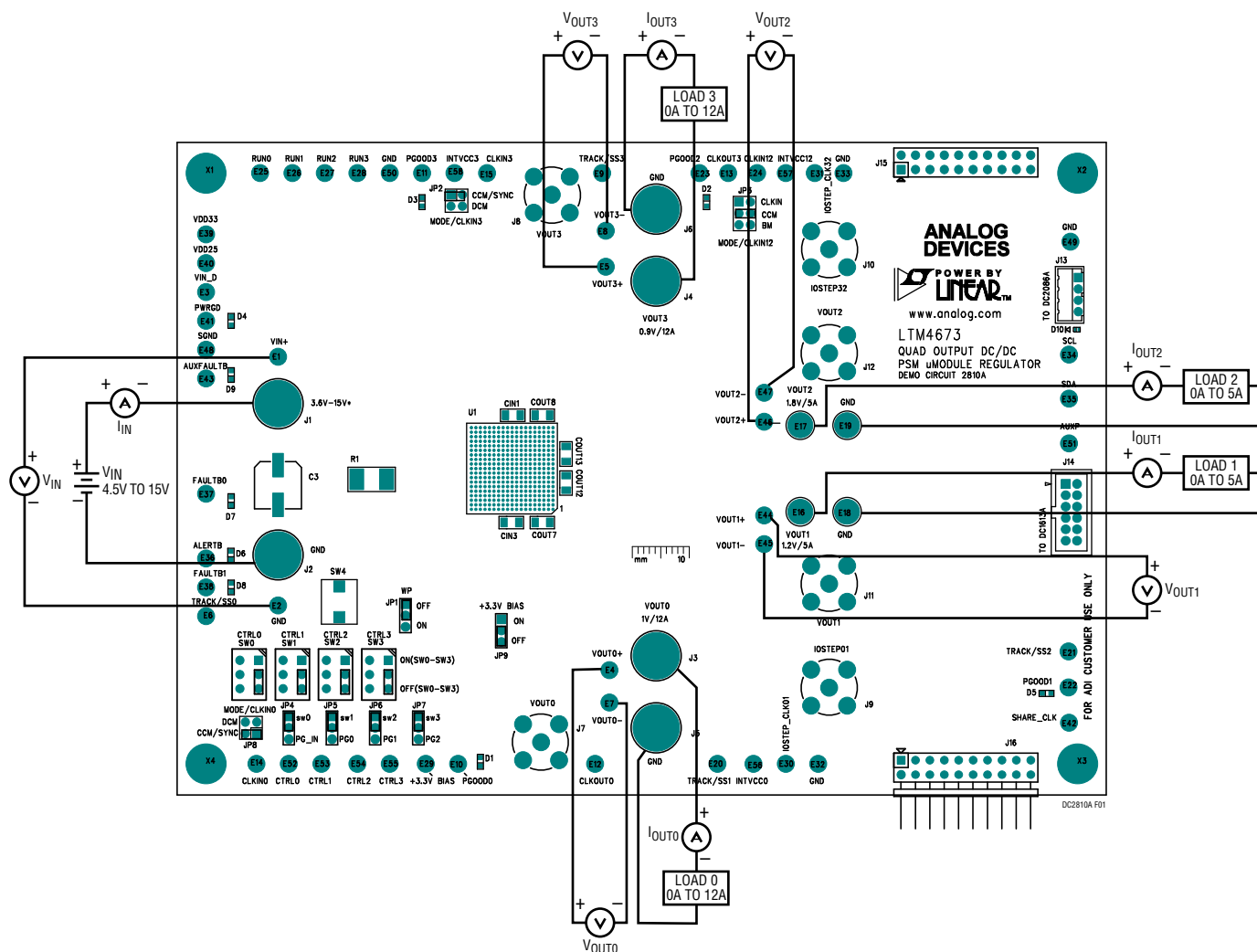

Figure 1. Proper Measurement Equipment Setup for DC2810A

Table 1. Demo Board Default Jumpers and Switches Position

JUMPER/SWITCH NAME	DESCRIPTION	DEFAULT POSITION
SW0, SW1, SW2, SW3	CTRL0, CTRL1, CTRL2, CTRL3	OFF
JP1	WP	OFF
JP2, JP3, JP8	MODE/CLKIN0, MODE/CLKIN12, MODE/CLKIN3	CCM
JP4	CH0 Sequence Configuration	SW0
JP5	CH1 Sequence Configuration	SW1
JP6	CH2 Sequence Configuration	SW2
JP7	CH3 Sequence Configuration	SW3
JP9	3.3V BIAS	OFF

QUICK START PROCEDURE

- Turn on the power supply at the input. Measure and bring up the input supply voltage to 12V. Flip SW0 (CTRL0), SW1 (CTRL1), SW2 (CTRL2), SW3 (CTRL3), to the “ON” position. The typical output voltages should be $1.0V \pm 0.5\%$ for V_{OUT0} , $1.2V \pm 0.5\%$ for V_{OUT1} , $1.8V \pm 0.5\%$ for V_{OUT2} , and $0.9V \pm 0.5\%$ for V_{OUT3} .
- Once the output voltages are properly established, vary the input voltage between 4.5V to 15V max. Vary the load current within the operating range of 0A to 12A for channels 0 and 3 and an operating range of 0A to 5A for channels 1 and 2. Observe the output voltage regulation, output ripple voltage, switching node waveforms, and other parameters.

NOTE: To measure the input/output voltage ripples properly, do not use the long ground lead on the oscilloscope probe. See Figure 2 for the proper probing technique of input/output voltage ripples. Short, stiff leads need to be soldered to the (+) and (-) terminals of an input or output capacitor. The probe's ground ring needs to touch the (-) lead and the probe tip needs to touch the (+) lead.

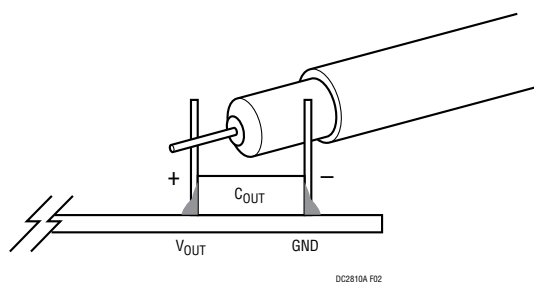

Figure 2. Scope Probe Placement for Measuring Input or Output Ripple Voltage

- DC2810A alternatively provides convenient onboard BNC terminals to accurately measure the output ripple voltage of channel 0, 1, 2 and 3. Connect short BNC cables from V_{OUT0} (J7), V_{OUT1} (J11), V_{OUT2} (J12), and V_{OUT3} (J8) to the input channels of an oscilloscope. (Scope probe ratio 1:1, AC-coupling) to observe the output ripple voltage.
- Operation at $V_{IN} \leq 4.5V$:
LTM4673 can be operated from 3.6V to 4.5V by using the onboard “3.3V bias” circuit. To use this circuit, set

3.3V Bias jumper to the ON position, remove R2 and stuff R4 and R77 with 0Ω resistors. Input Voltage parameters must be changed in LTpowerPlay to allow the part to operate at low V_{IN} voltages. Additional input electrolytic capacitors may be installed between V_{IN} (J1) and GND (J2) to prevent V_{IN} from drooping or overshoot to a voltage level that can exceed the specified minimum V_{IN} (3.6V) and maximum V_{IN} (4.5V) during large output load transient.

Similarly, the part can be run from a single 3.3V voltage supply by stuffing R4, R2 and R77 with 0Ω resistors and placing the 3.3V jumper in the OFF position. Do not exceed 3.6V when configuring the board this way.

- Onboard Load-Step Circuit:

DC2810A provides onboard load transient circuits to quickly check ΔV_{OUT} peak-to-peak deviation during rising or falling dynamic load transients for each channel.

The simple load-step circuit consists of a 20V N-channel power MOSFET in series with a $10m\Omega$, 0.5W, 1% current sense resistor. The MOSFET is configured as a voltage control current source (VCCS) device; therefore, the output current step and its magnitude is created and controlled by adjusting the amplitude of the applied input voltage step at the gate of the MOSFET. Use a function generator to provide a voltage pulse between IOSTEP_CLK01 (E30) and GND; this voltage pulse should be set at a pulse width less than $300\mu s$ and maximum duty cycle less than 2% to avoid excessive thermal stress on the MOSFET devices. The output current step is measured directly across the current sense resistors and monitored by connecting BNC cable from IOSTEP_01 (J9) to the input of the oscilloscope (scope probe ratio 1:1, DC-coupling). The equivalent voltage to current scale is $10mV/1A$. The load step current slew rate di/dt can be varied by adjusting the rise time and fall time of the input voltage pulse. The load-step circuit of channel 0 or channel 1 is connected to V_{OUT0} by default but can be used for V_{OUT1} by simply removing the zero-ohm resistor R94 and stuffing it at the position of R100 and vice versa. Only one resistor: R94 or R100 can be stuffed at a time to avoid shorting V_{OUT0} and V_{OUT1} together.

QUICK START PROCEDURE

Similarly, load-step transient evaluation of V_{OUT2} or V_{OUT3} can be performed using the same method described above using the second onboard dynamic load circuit.

10. Connecting a PC to DC2810A:

Refer to Figure 3 for proper demo board setup with PC. Users can use a PC to reconfigure the

power management features of the LTM4673 such as: nominal V_{OUT} , margin set points, OV/UV limits, OC/UC limits, temperature fault limits, sequencing parameters, the fault logs, fault responses, GPIOs and other functionality. The DC1613A dongle can be hot plugged when V_{IN} is present.

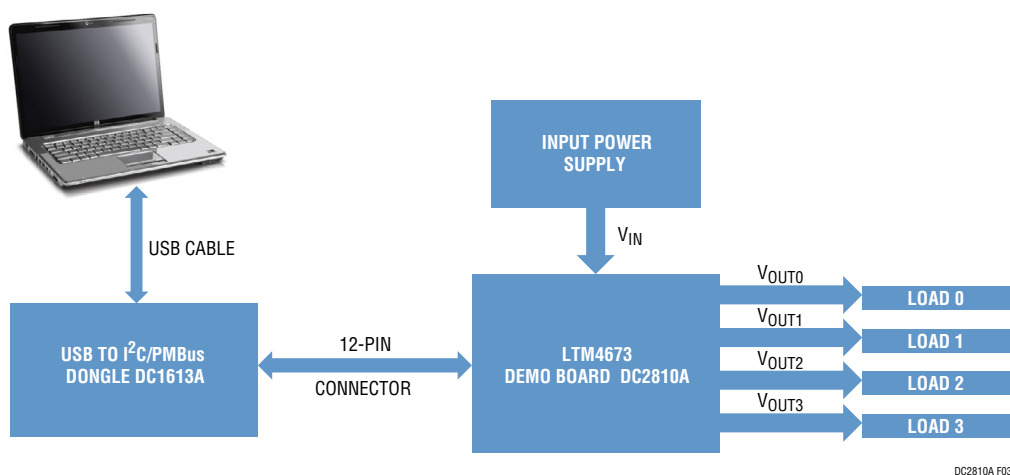
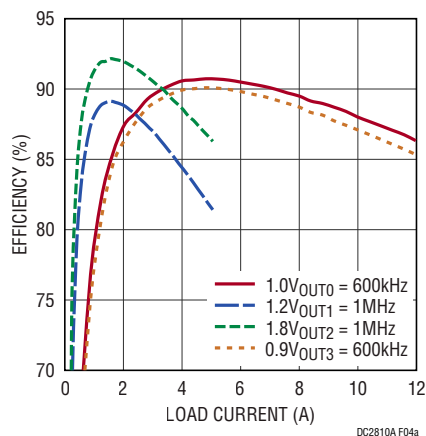
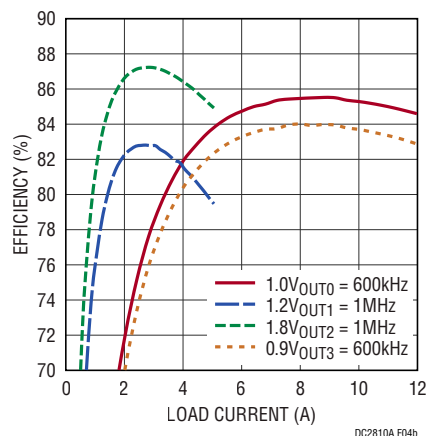

Figure 3. DC2810A Demo Board Setup with PC for DC2810A

TEST RESULTS



(a) 4.5 V_{IN} CCM Efficiency



(b) 12 V_{IN} CCM Efficiency

Figure 4. Measured Supply Efficiency

TEST RESULTS

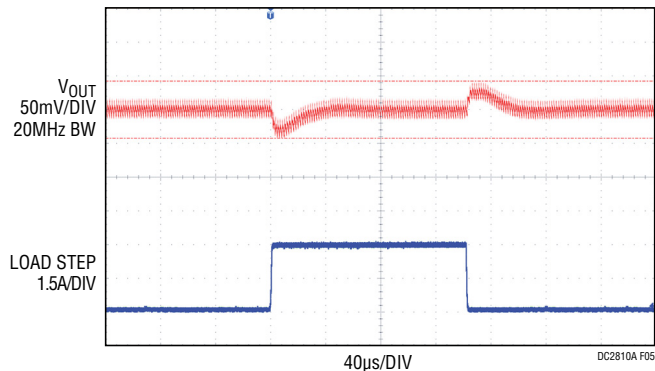

CHANNEL 0 SINGLE OUTPUT CONFIGURATION

$f_{SW} = 600\text{kHz}$
 $V_{IN} = 12\text{V}$, $V_{OUT} = 1.0\text{V}$
 INTERNAL COMP, $C_{FF} = 150\text{pF}$
 $I_{LOAD} = 0\text{A TO } 3\text{A TO } 0\text{A}$
 $V_{OUT} \text{ PEAK-TO-PEAK} = 84\text{mV}$

Figure 5. DC2810A: Channel 0 Load Transient Response

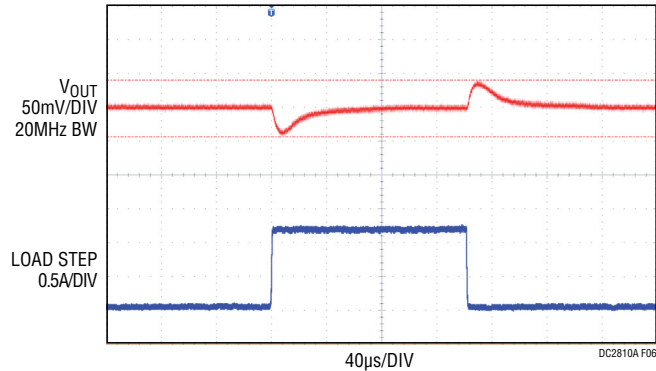

CHANNEL 1 SINGLE OUTPUT CONFIGURATION

$f_{SW} = 1000\text{kHz}$
 $V_{IN} = 12\text{V}$, $V_{OUT} = 1.2\text{V}$
 INTERNAL COMP, $C_{FF} = 22\text{pF}$
 $I_{LOAD} = 0\text{A TO } 1.25\text{A TO } 0\text{A}$
 $V_{OUT} \text{ PEAK-TO-PEAK} = 84\text{mV}$

Figure 6. DC2810A: Channel 1 Load Transient Response

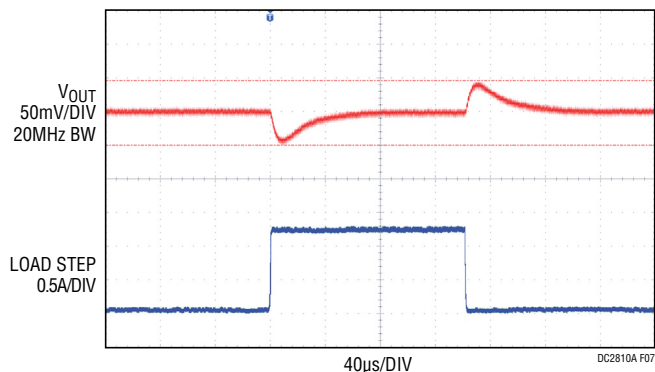

SINGLE OUTPUT CONFIGURATION

$f_{SW} = 1000\text{kHz}$
 $V_{IN} = 12\text{V}$, $V_{OUT} = 1.8\text{V}$
 INTERNAL COMP, $C_{FF} = 22\text{pF}$
 $I_{LOAD} = 0\text{A TO } 1.25\text{A TO } 0\text{A}$
 $V_{OUT} \text{ PEAK-TO-PEAK} = 96\text{mV}$

Figure 7. DC2810A: Channel 2 Load Transient Response

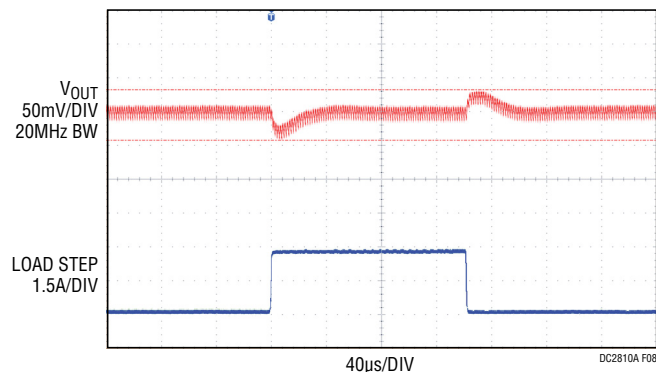

SINGLE OUTPUT CONFIGURATION

$f_{SW} = 600\text{kHz}$
 $V_{IN} = 12\text{V}$, $V_{OUT} = 0.9\text{V}$
 INTERNAL COMP, $C_{FF} = 150\text{pF}$
 $I_{LOAD} = 0\text{A TO } 3\text{A TO } 0\text{A}$
 $V_{OUT} \text{ PEAK-TO-PEAK} = 74\text{mV}$

Figure 8. DC2810A: Channel 3 Load Transient Response

TEST RESULTS

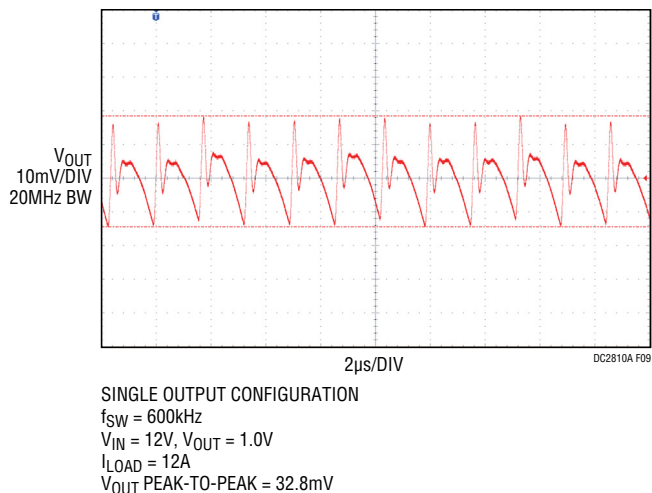

Figure 9. DC2810A: Channel 0 Output Voltage Ripple

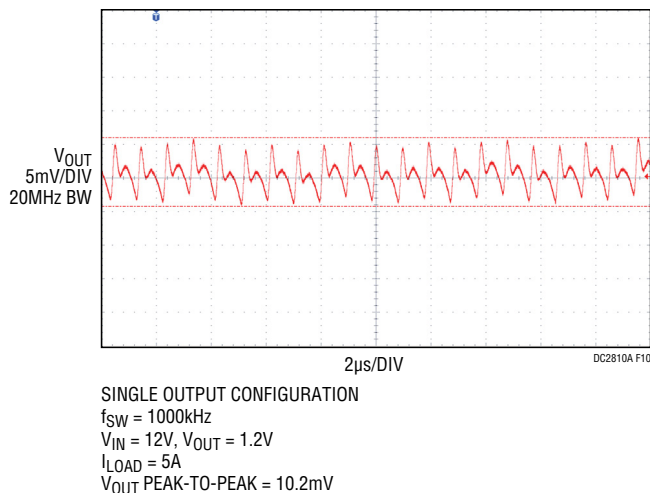

Figure 10. DC2810A: Channel 1 Output Voltage Ripple

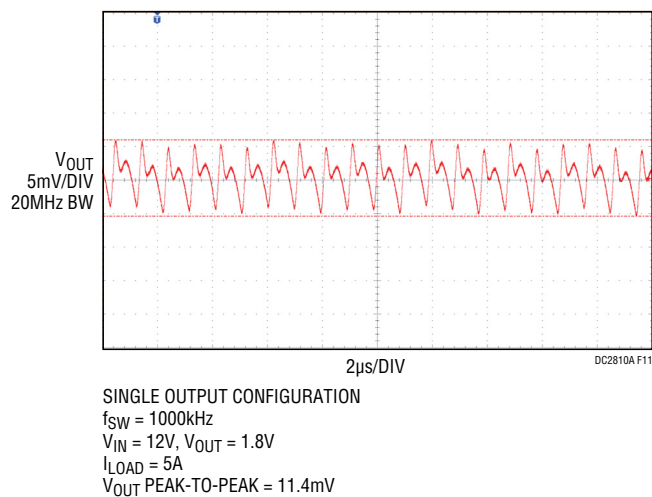

Figure 11. DC2810A: Channel 2 Output Voltage Ripple

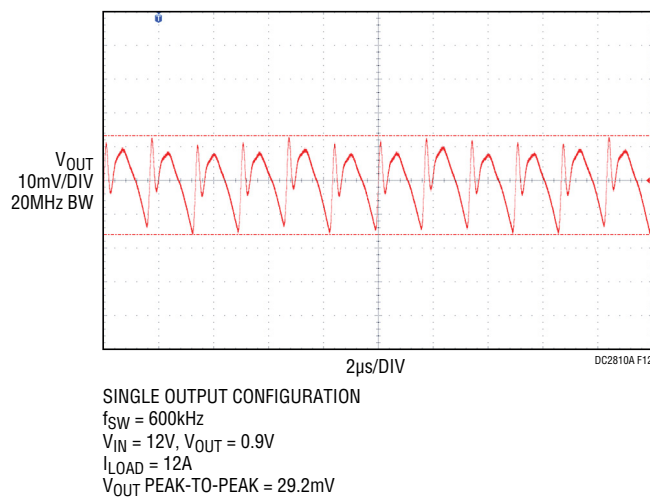
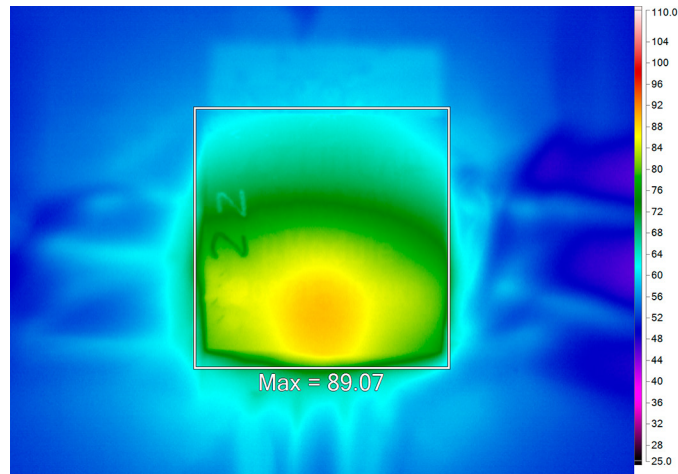

Figure 12. DC2810A: Channel 3 Output Voltage Ripple

TEST RESULTS



V_{IN} (V)	HEATSINK	AMBIENT ($^{\circ}$ C)	MAX CASE TEMP ($^{\circ}$ C)
4.5	NONE	23	89.07

CHANNEL	V_{OUT0}	V_{OUT1}	V_{OUT2}	V_{OUT3}
V_{OUT} (V)	1.0	1.2	1.8	0.9
I_{OUT} (A)	12	5	5	12

(a)

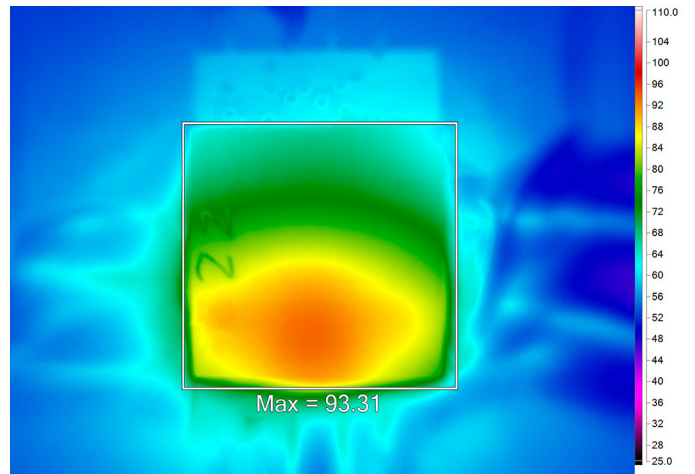

V_{IN} (V)	HEATSINK	AMBIENT ($^{\circ}$ C)	MAX CASE TEMP ($^{\circ}$ C)
12	NONE	23	93.31

CHANNEL	V_{OUT0}	V_{OUT1}	V_{OUT2}	V_{OUT3}
V_{OUT} (V)	1.0	1.2	1.8	0.9
I_{OUT} (A)	12	5	5	12

(b)

Figure 13. Measured Thermal Captures without Forced Airflow

LTpowerPlay QUICK START GUIDE

LTpowerPlay is a powerful Windows-based development environment that supports ADI power system management ICs. The software supports a variety of different tasks. You can use LTpowerPlay to evaluate ADI PSM ICs by connecting to a demo board system. LTpowerPlay can also be used in an offline mode (with no hardware present) to build a multichip configuration file that can be saved and reloaded anytime. LTpowerPlay provides unprecedented diagnostic tool and debug features. It becomes a valuable diagnostic tool during board bring-up to program or tweak the power management scheme in a system, or to diagnose power issues when bringing up rails. LTpowerPlay utilizes the DC1613A USB-to-SMBus

controller to communicate with one of many potential targets, including all the parts in PSM product category demo system. The software also provides an automatic update feature to keep the software current with the latest set of device drivers and documentation. The LTpowerPlay software can be downloaded [here](#).

To access technical support documents for ADI Digital Management Products, visit Help or view online help on the LTpowerPlay menu.

The following procedure describes how to use LTpowerPlay to monitor and change the settings of LTM4673:

1. Download and install the [LTpowerPlay GUI](#).

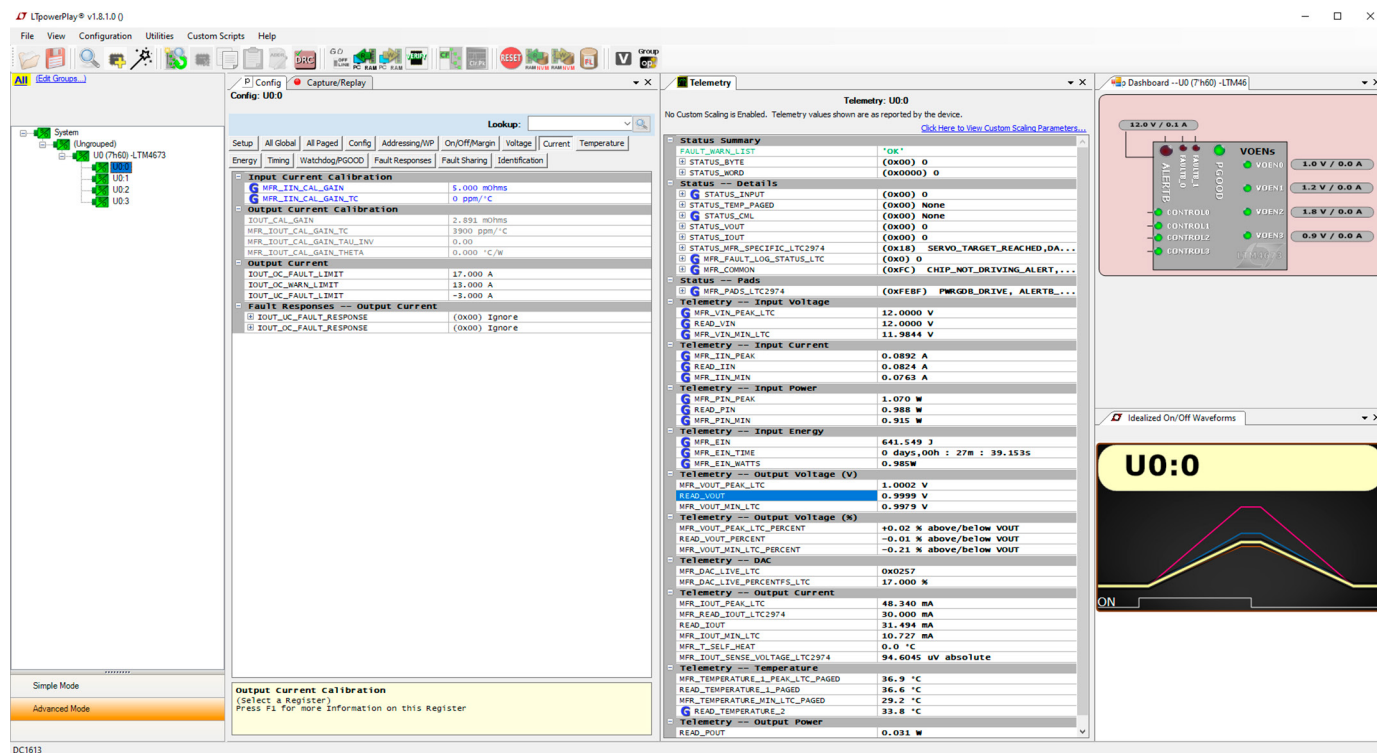

Figure 14. LTpowerPlay Main Interface

DEMO MANUAL DC2810A

LTpowerPlay QUICK START GUIDE

2. Launch the LTpowerPlay GUI.

a. The GUI should automatically identify the DC2810A.

The system tree on the left-hand side should look like this:

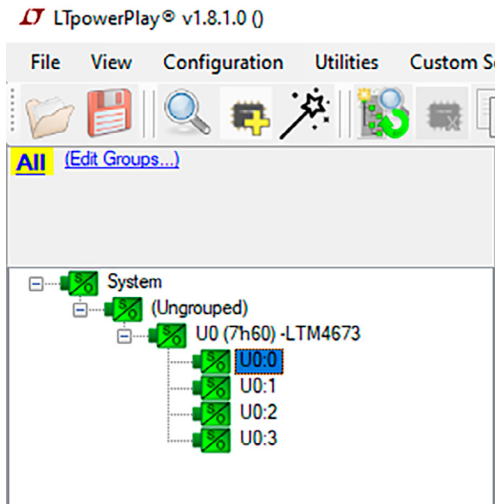

b. A message box shows for a few seconds in the lower left-hand corner, confirming that the LTM4673 is communicating:

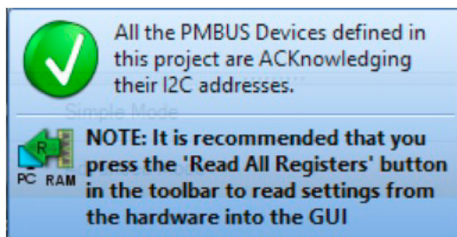

c. In the Toolbar, click the “R” (RAM to PC) icon to read the RAM from the LTM4673. The configuration is read from LTM4673 and loaded into the GUI.



d. For example, the V_{IN} Turn on voltage can be programmed to a different value: In the Config Tab, click on the “Voltage” box in the main menu bar and type in “5.0” in the VIN_ON box as shown below:

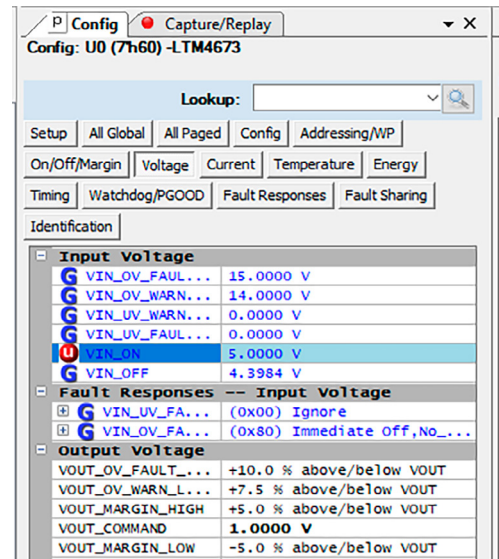

Then click the “W” (PC to RAM) icon to write these register values to the LTM4673.



The V_{IN} turn on voltage will change to 5V. If the write is successful, the following message should be seen:

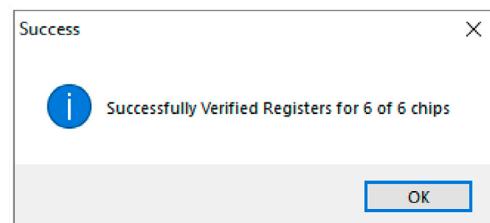

e. All user configurations or changes can be saved in to the NVM. In the toolbar, click “RAM to NVM” icon:



f. Save the demo board configuration to a (*.proj) file. Click the “Save” icon and save the file with a preferred file name.

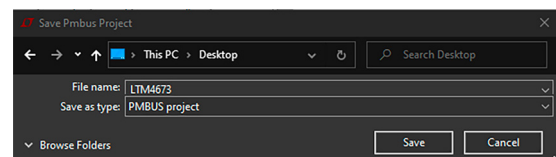

PARTS LIST

ITEM	QTY	REFERENCE	PART DESCRIPTION	MANUFACTURER/PART NUMBER
Required Circuit Components				
1	3	C1, C5, C12	CAP, 2.2µF, X5R, 6.3V, 10%, 0603	AVX, 06036D225KAT2A
2	9	C2, C6, C21, C22, C39, C41-C44	CAP, 0.1µF, X7R, 16V, 10%, 0603, FLEXITERM	AVX, 0603YC104KAZ2A
3	2	C3, C4	CAP, 100µF, ALUM, OS-CON, 25V, 20%, 8mm × 6.9mm SMD, E7, SVPF SERIES	PANASONIC, 25SVPF100M
4	3	C7, C9, C10	CAP, 1µF, X7R, 25V, 10%, 0603, AEC-Q200	MURATA, GCM188R71E105KA64D
5	1	C11	CAP, 10µF, X5R, 25V, 20%, 0603, NO SUBS. ALLOWED	MURATA, GRM188R61E106MA73D
6	2	C15, C16	CAP, 150pF, X7R, 50V, 10%, 0603	AVX, 06035C151KAT2A
7	2	C23, C24	CAP, 22pF, C0G, 50V, 5%, 0603	AVX, 06035A220JAT2A
8	6	C27, C28, C45-C48	CAP, 0.01µF, X7R, 16V, 10%, 0603	AVX, 0603YC103KAT2A
9	1	C29	CAP, 1µF, X7R, 16V, 10%, 0603	KEMET, C0603C105K4RAC7867
10	1	C35	CAP, 10µF, X7R, 25V, 10%, 1206	KEMET, C1206C106K3RACTU
11	1	C36	CAP, 10µF, X5R, 16V, 20%, 1210	AVX, 1210YD106MAT2A
12	1	C37	CAP, 0.01µF, X7R, 6.3V, 10%, 0603	AVX, 06036C103KAT2A
13	6	C38, C40, COUT3, COUT4, COUT7, COUT8	CAP, 100µF, X5R, 6.3V, 10%, 1206	MURATA, GRM31CR60J107KE39L
14	4	CIN1-CIN4	CAP, 22µF, X5R, 25V, 10%, 1206	AVX, 12063D226KAT2A
15	2	COUT2, COUT5	CAP, 330µF, TANT, POSCAP, 6.3V, 20%, 7343, 10mΩ, TPF	PANASONIC, 6TPF330M9L
16	2	COUT10, COUT15	CAP, 10µF, X5R, 6.3V, 10%, 0805	AVX, 08056D106KAT2A
17	4	COUT11-COUT14	CAP, 47µF, X5R, 6.3V, 20%, 1206	MURATA, GRM31CR60J476ME19L
18	5	D1-D5	LED, GREEN, WATER CLEAR, 0603	WURTH ELEKTRONIK, 150060GS75000
19	4	D6-D9	LED, RED, WATER CLEAR, 0603	WURTH ELEKTRONIK, 150060RS75000
20	1	D10	DIODE, SCHOTTKY, 20V, 0.5A, SOD-882, LEADLESS	NEXPERIA, PMEG2005AEL, 315
21	1	Q1	XSTR., MOSFET, P-CH, 30V, 3.3A, SOT-23-3	DIODES INC., DMP3068L-13
22	2	Q2, Q3	XSTR., MOSFET, N-CH, 40V, 14A, DPAK (TO-252)	VISHAY, SUD50N04-8M8P-4GE3
23	5	Q4-Q8	XSTR., MOSFET, N-CH, 60V, 220mA, SOT23-3, AEC-Q101	DIODES INC., 2N7002A-13
24	4	Q9-Q12	XSTR., MOSFET, P-CH, 20V, 5.9A, SOT-23-3 (TO-236-3)	VISHAY, Si2365EDS-T1-GE3
25	1	R1	RES., 0.005Ω, 1%, 3W, 2512, METAL, SENSE, AEC-Q200	PANASONIC, ERJMS4HF5MOU
26	16	R2, R12, R15, R18-R21, R30, R31, R34, R38, R39, R50, R51, R122, R124	RES., 0Ω, 1/10W, 0603, AEC-Q200	VISHAY, CRCW06030000Z0EA
27	6	R3, R37, R132-R135	RES., 10Ω, 1%, 1/10W, 0603	VISHAY, CRCW060310R0FKEA
28	2	R5, R6	RES., 100Ω, 1%, 1/10W, 0603, AEC-Q200	PANASONIC, ERJ3EKF1000V
29	2	R8, R9	RES., 1Ω, 1%, 1/10W, 0603	YAGEO, RC0603FR-071RL
30	4	R10, R11, R32, R33	RES., 0Ω, JUMPER, 0603, AEC-Q200	KOA SPEER, RK73Z1JTDD
31	1	R13	RES., 90.9k, 1%, 1/10W, 0603, AEC-Q200	VISHAY, CRCW060390K9FKEA
32	1	R14	RES., 121k, 1%, 1/10W, 0603	NIC, NRC06F1213TRF
33	4	R26, R27, R42, R43	RES., 100k, 1%, 1/10W, 0603	STACKPOLE ELECTRONICS, INC., RMC0603FG100K
34	1	R35	RES., 60.4k, 1%, 1/10W, 0603	NIC, NRC06F6042TRF
35	1	R36	RES., 30.1k, 0.1%, 1/10W, 0603, AEC-Q200	PANASONIC, ERA-3AEB3012V
36	6	R45, R47, R54, R81, R96, R98	RES., 10k, 1%, 1/10W, 0603	VISHAY, CRCW060310K0FKEC
37	5	R46, R48, R49, R129, R130	RES., 4.99k, 1%, 1/10W, 0603	PANASONIC, ERJ3EKF4991V
38	1	R52	RES., 715k, 1%, 1/10W, 0603	YAGEO, RC0603FR-07715KL
39	1	R56	RES., 590k, 1%, 1/10W, 0603, AEC-Q200	PANASONIC, ERJ3EKF5903V

DEMO MANUAL DC2810A

PARTS LIST

ITEM	QTY	REFERENCE	PART DESCRIPTION	MANUFACTURER/PART NUMBER
40	1	R59	RES., 402k, 1%, 1/10W, 0603	YAGEO, RC0603FR-07402KL
41	1	R60	RES., 787k, 0.1%, 1/10W, 0603, AEC-Q200	KOA SPEER, RN73H1JTTD7873B25
42	1	R80	RES., 422k, 1%, 1/10W, 0603, AEC-Q200	NIC, NRC06F4223TRF
43	1	R85	RES., 249k, 1%, 1/10W, 0603	YAGEO, RC0603FR-07249KL
44	2	R94, R95	RES., 0Ω, 1/2W, 1210, AEC-Q200	VISHAY, CRCW1210000Z0EA
45	2	R97, R99	RES., 0.01Ω, 1%, 2W, 2512, HIGH PWR, METAL, SENSE, AEC-Q200	VISHAY, WSL2512R0100FEA18
46	5	R102-R106	RES., 200Ω, 1%, 1/10W, 0603	VISHAY, CRCW0603200RFKEA
47	4	R111-R114	RES., 127Ω, 1%, 1/10W, 0603, AEC-Q200	NIC, NRC06F1270TRF
48	4	SW0-SW3	SWITCH, SLIDE, DPDT, 0.3A, 6VDC, PTH	C&K, JS202011CQN
49	1	SW4	SWITCH, TACT., SPST, 0.05A, 12VDC, VERT, 6mm × 3.5mm SMD, BLK, TOP PUSH	ALPS ELECTRIC, SKQMASE010
50	1	U1	IC, QUAD OUTPUT DC/D μModule REG., BGA-361	ANALOG DEVICES, LTM4673IY#PBF
51	1	U2	IC, 500mA, LDO μPOWER REG., ADJ., SO-8	ANALOG DEVICES, LT1763CS8#PBF
52	1	U3	IC, EEPROM, I ² C, TSSOP-8, 2Kb (256 × 8), 400kHz	MICROCHIP, 24LC024-I/ST

Additional Demo Board Circuit Components

1	0	C8, C13, C14, C17-C20, C25, C26, C30	CAP, OPTION, 0603	
2	0	COUT1, COUT6	CAP, OPTION, 7343	
3	0	COUT9, COUT16	CAP, OPTION, 1206	
4	0	R4, R7, R16, R17, R22-R25, R28, R29, R40, R41, R44, R53, R55, R57, R58, R61-R64, R73-R79, R82-R84, R86-R93, R107-R110, R115-R121, R123, R125-R128, R131, R136-R139	RES., OPTION, 0603	
5	0	R71	RES., OPTION, 2512	
6	0	R72	RES., OPTION, 1206	
7	0	R100, R101	RES., OPTION, 1210	

Hardware: For Demo Board Only

1	54	E1-E15, E20-E58	TEST POINT, TURRET, 0.064" MTG. HOLE, PCB 0.062" THK	MILL-MAX, 2308-2-00-80-00-00-07-0
2	4	E16-E19	TEST POINT, TURRET, 0.094" MTG. HOLE, PCB 0.062" THK	MILL-MAX, 2501-2-00-80-00-00-07-0
3	6	J1-J6	CONN., BANANA JACK, FEMALE, THT, NON INSULATED, SWAGE, 0.218"	KEYSTONE, 575-4
4	6	J7-J12	CONN., RF BNC, RCPT, JACK, 5-PIN, ST, THT, 50Ω	AMPHENOL RF, 112404
5	1	J13	CONN., HDR, SHROUDED, MALE, 1×4, 2mm, VERT, ST, THT	HIROSE ELECTRIC, DF3A-4P-2DSA
6	1	J14	CONN., HDR, SHROUDED, MALE, 2×6, 2mm, VERT, ST, THT	AMPHENOL, 98414-G06-12ULF
7	1	J15	CONN., HDR, RCPT, FEMALE, 2×10, 2.54mm, R/A, THT	MILL-MAX, 803-43-020-20-001000
8	1	J16	CONN., HDR, MALE, 2×10, 2.54mm, R/A, THT	MILL-MAX, 802-40-020-20-001000
9	6	JP1, JP4-JP7, JP9	CONN., HDR, MALE, 1×3, 2mm, VERT, ST, THT, NO SUBS. ALLOWED	SAMTEC, TMM-103-02-L-S
10	2	JP2, JP8	CONN., HDR, MALE, 2×2, 2mm, VERT, ST, THT, 10μ Au	SAMTEC, TMM-102-02-L-D
11	1	JP3	CONN., HDR, MALE, 2×3, 2mm, VERT, ST, THT	SAMTEC, TMM-103-02-L-D
12	4	MP1-MP4	STANDOFF, NYLON, SNAP-ON, 0.25" (6.4mm)	KEYSTONE, 8831
13	9	XJP1-XJP9	CONN., SHUNT, FEMALE, 2-POS, 2mm	SAMTEC, 2SN-BK-G

SCHEMATIC DIAGRAM

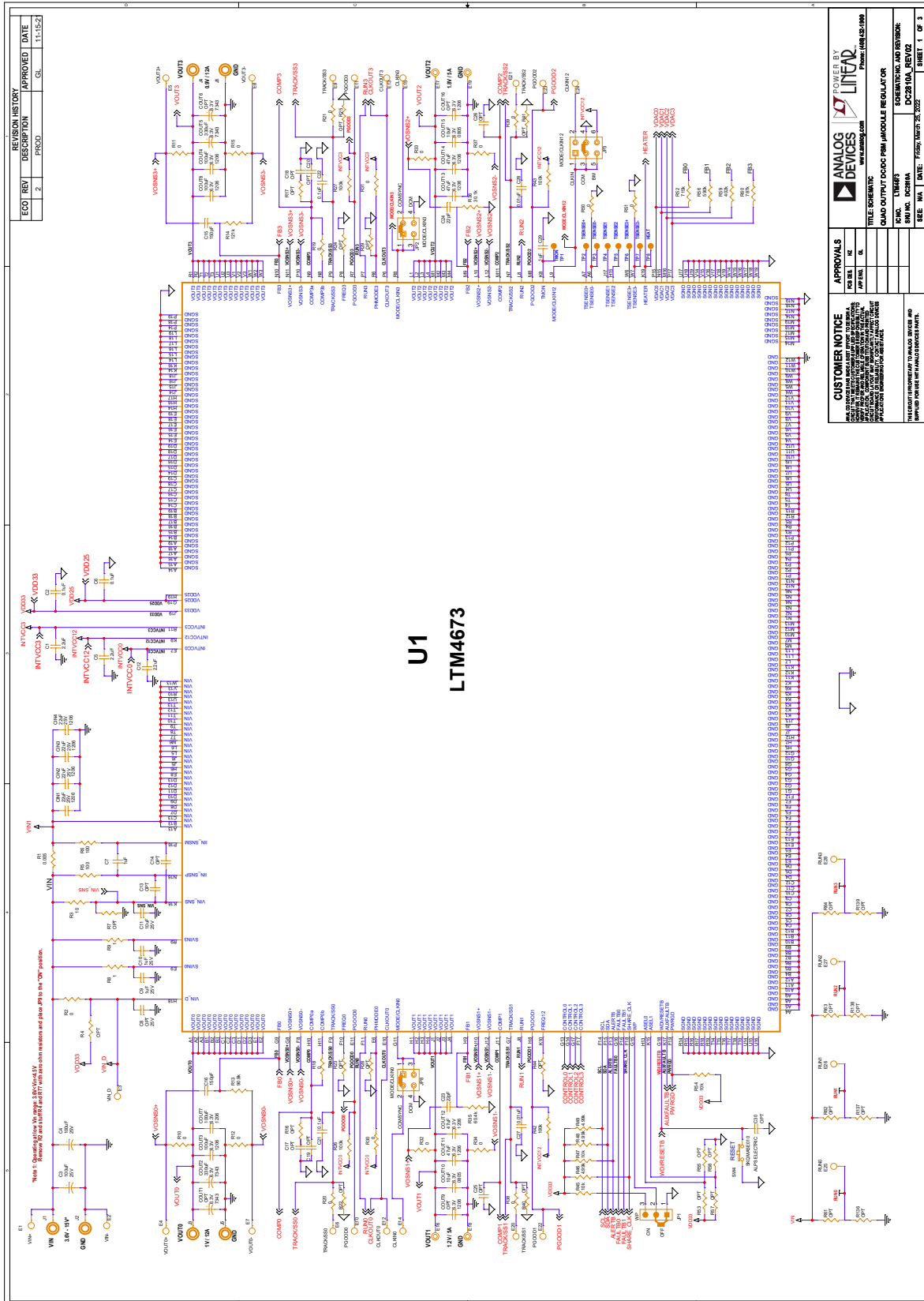

DEMO MANUAL DC2810A

SCHEMATIC DIAGRAM

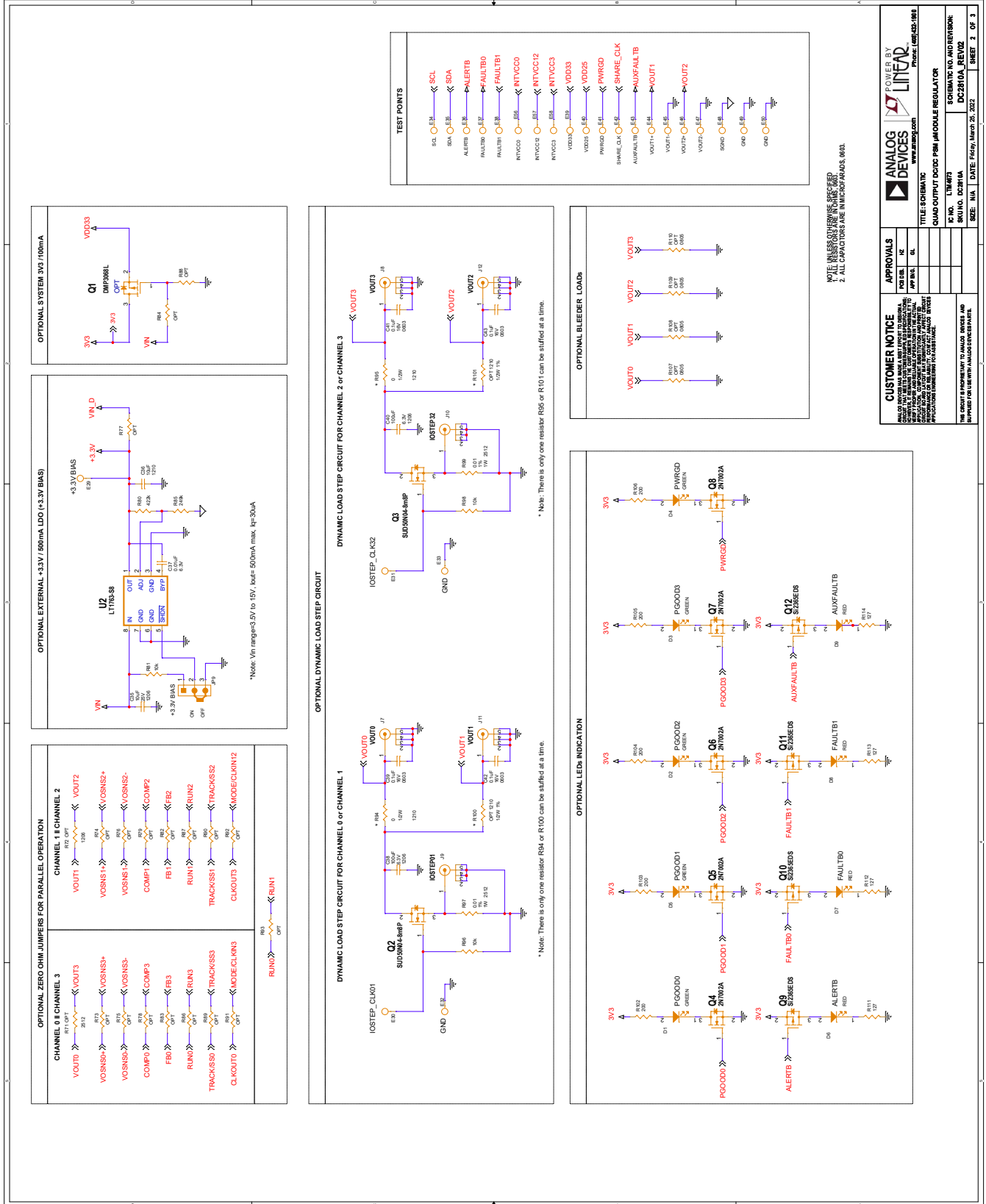

SCHEMATIC DIAGRAM

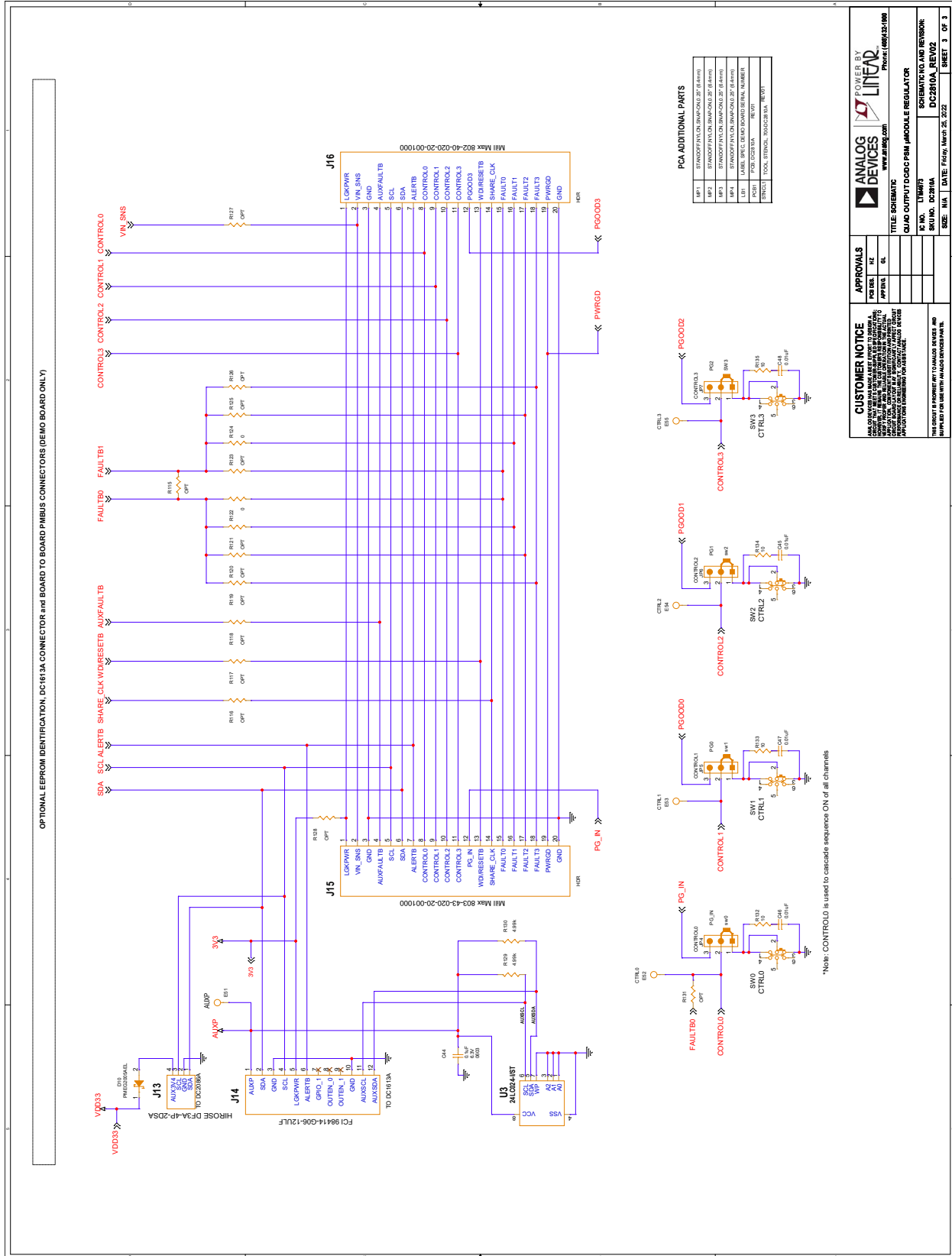



ESD Caution



ESD (electrostatic discharge) sensitive device. Charged devices and circuit boards can discharge without detection. Although this product features patented or proprietary protection circuitry, damage may occur on devices subjected to high energy ESD. Therefore, proper ESD precautions should be taken to avoid performance degradation or loss of functionality.

Legal Terms and Conditions

By using the evaluation board discussed herein (together with any tools, components documentation or support materials, the "Evaluation Board"), you are agreeing to be bound by the terms and conditions set forth below ("Agreement") unless you have purchased the Evaluation Board, in which case the Analog Devices Standard Terms and Conditions of Sale shall govern. Do not use the Evaluation Board until you have read and agreed to the Agreement. Your use of the Evaluation Board shall signify your acceptance of the Agreement. This Agreement is made by and between you ("Customer") and Analog Devices, Inc. ("ADI"), with its principal place of business at One Technology Way, Norwood, MA 02062, USA. Subject to the terms and conditions of the Agreement, ADI hereby grants to Customer a free, limited, personal, temporary, non-exclusive, non-sublicensable, non-transferable license to use the Evaluation Board FOR EVALUATION PURPOSES ONLY. Customer understands and agrees that the Evaluation Board is provided for the sole and exclusive purpose referenced above, and agrees not to use the Evaluation Board for any other purpose. Furthermore, the license granted is expressly made subject to the following additional limitations: Customer shall not (i) rent, lease, display, sell, transfer, assign, sublicense, or distribute the Evaluation Board; and (ii) permit any Third Party to access the Evaluation Board. As used herein, the term "Third Party" includes any entity other than ADI, Customer, their employees, affiliates and in-house consultants. The Evaluation Board is NOT sold to Customer; all rights not expressly granted herein, including ownership of the Evaluation Board, are reserved by ADI. CONFIDENTIALITY. This Agreement and the Evaluation Board shall all be considered the confidential and proprietary information of ADI. Customer may not disclose or transfer any portion of the Evaluation Board to any other party for any reason. Upon discontinuation of use of the Evaluation Board or termination of this Agreement, Customer agrees to promptly return the Evaluation Board to ADI. ADDITIONAL RESTRICTIONS. Customer may not disassemble, decompile or reverse engineer chips on the Evaluation Board. Customer shall inform ADI of any occurred damages or any modifications or alterations it makes to the Evaluation Board, including but not limited to soldering or any other activity that affects the material content of the Evaluation Board. Modifications to the Evaluation Board must comply with applicable law, including but not limited to the RoHS Directive. TERMINATION. ADI may terminate this Agreement at any time upon giving written notice to Customer. Customer agrees to return to ADI the Evaluation Board at that time. LIMITATION OF LIABILITY. THE EVALUATION BOARD PROVIDED HEREUNDER IS PROVIDED "AS IS" AND ADI MAKES NO WARRANTIES OR REPRESENTATIONS OF ANY KIND WITH RESPECT TO IT. ADI SPECIFICALLY DISCLAIMS ANY REPRESENTATIONS, ENDORSEMENTS, GUARANTEES, OR WARRANTIES, EXPRESS OR IMPLIED, RELATED TO THE EVALUATION BOARD INCLUDING, BUT NOT LIMITED TO, THE IMPLIED WARRANTY OF MERCHANTABILITY, TITLE, FITNESS FOR A PARTICULAR PURPOSE OR NON-INFRINGEMENT OF INTELLECTUAL PROPERTY RIGHTS. IN NO EVENT WILL ADI AND ITS LICENSORS BE LIABLE FOR ANY INCIDENTAL, SPECIAL, INDIRECT, OR CONSEQUENTIAL DAMAGES RESULTING FROM CUSTOMER'S POSSESSION OR USE OF THE EVALUATION BOARD, INCLUDING BUT NOT LIMITED TO LOST PROFITS, DELAY COSTS, LABOR COSTS OR LOSS OF GOODWILL. ADI'S TOTAL LIABILITY FROM ANY AND ALL CAUSES SHALL BE LIMITED TO THE AMOUNT OF ONE HUNDRED US DOLLARS (\$100.00). EXPORT. Customer agrees that it will not directly or indirectly export the Evaluation Board to another country, and that it will comply with all applicable United States federal laws and regulations relating to exports. GOVERNING LAW. This Agreement shall be governed by and construed in accordance with the substantive laws of the Commonwealth of Massachusetts (excluding conflict of law rules). Any legal action regarding this Agreement will be heard in the state or federal courts having jurisdiction in Suffolk County, Massachusetts, and Customer hereby submits to the personal jurisdiction and venue of such courts. The United Nations Convention on Contracts for the International Sale of Goods shall not apply to this Agreement and is expressly disclaimed.

Looking for pricing, stock, or lifecycle information?

Click below to explore more details on WIN SOURCE:

-  [View DC2810A on WIN SOURCE](#)
-  [Analog Devices Inc. Information](#)

Optimize Your Supply Chain with WIN SOURCE Solutions

-  Global Sourcing Solution
-  Obsolete Management
-  Cost Control Management
-  Shortage Management
-  Alternative Solution
-  Excess Inventory Management