



**THE DATASHEET OF
ANNA-B112-01B**



ANNA-B112

Stand-alone Bluetooth 5 low energy module

Data sheet

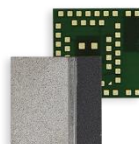

Abstract

This technical data sheet describes the ultra-compact ANNA-B112 stand-alone Bluetooth® 5 low energy module packed into a System-in-Package design. Despite the small size, ANNA-B112 offers an internal antenna option. With embedded Bluetooth low energy stack and u-connectXpress software, this SiP module is tailored for OEMs who wish to have the shortest time-to-market. ANNA-B112 offers full flexibility, and the OEMs can embed their own application on top of the integrated Bluetooth low energy stack using Nordic SDK or Arm® Mbed™ integrated development environment (IDE).

Document information

| | | |
|-------------------------------|---|-------------|
| Title | ANNA-B112 | |
| Subtitle | Stand-alone Bluetooth 5 low energy module | |
| Document type | Data sheet | |
| Document number | UBX-18011707 | |
| Revision and date | R12 | 14-Mar-2023 |
| Disclosure Restriction | C1-Public | |

| Product status | Corresponding content status | |
|--------------------------------------|-------------------------------------|--|
| Functional sample | Draft | For functional testing. Revised and supplementary data will be published later. |
| In development / Prototype | Objective specification | Target values. Revised and supplementary data will be published later. |
| Engineering sample | Advance information | Data based on early testing. Revised and supplementary data will be published later. |
| Initial production | Early production information | Data from product verification. Revised and supplementary data may be published later. |
| Mass production / End of life | Production information | Document contains the final product specification. |

This document applies to the following products:

| Product name | Type number | u-connectXpress software version | Hardware version | PCN reference | Product status |
|---------------------|--------------------|---|-------------------------|----------------------|-----------------------|
| ANNA-B112 | ANNA-B112-00B-00 | 1.0.0 | 03 | N/A | Mass production |
| ANNA-B112 | ANNA-B112-01B-00 | 2.0.0 | 03 | N/A | Mass production |
| ANNA-B112 | ANNA-B112-70B-00 | N/A | 03 | N/A | Mass production |
| ANNA-B112 | ANNA-B112-02B-00 | 4.0.0 | 03 | N/A | Mass production |

u-blox or third parties may hold intellectual property rights in the products, names, logos, and designs included in this document. Copying, reproduction, or modification of this document or any part thereof is only permitted with the express written permission of u-blox. Disclosure to third parties is permitted for clearly public documents only.

The information contained herein is provided "as is" and u-blox assumes no liability for its use. No warranty, either express or implied, is given, including but not limited to, with respect to the accuracy, correctness, reliability, and fitness for a particular purpose of the information. This document may be revised by u-blox at any time without notice. For the most recent documents, visit www.u-blox.com.

Copyright © u-blox AG.

Contents

| | |
|--|-----------|
| Document information | 2 |
| Contents | 3 |
| 1 Functional description | 5 |
| 1.1 Overview | 5 |
| 1.2 Product features | 6 |
| 1.3 Block diagram | 7 |
| 1.4 Product description | 8 |
| 1.5 Software options | 8 |
| 1.5.1 u-connectXpress software | 9 |
| 1.5.2 Open CPU | 9 |
| 1.6 Bluetooth device address | 9 |
| 2 Interfaces | 10 |
| 2.1 Power management | 10 |
| 2.1.1 Module supply input (VCC) | 10 |
| 2.2 RF antenna interfaces | 10 |
| 2.2.1 2.4 GHz Bluetooth low energy (ANT) | 10 |
| 2.2.2 Near Field Communication (NFC) | 10 |
| 2.3 Low Power Oscillator interface | 10 |
| 2.4 System functions | 11 |
| 2.4.1 Module power-on | 11 |
| 2.4.2 Module power-off | 11 |
| 2.4.3 Standby mode | 11 |
| 2.4.4 Sleep mode | 12 |
| 2.4.5 Module reset | 12 |
| 2.4.6 Real Time Counter (RTC) | 12 |
| 2.5 Serial interfaces | 12 |
| 2.5.1 Asynchronous serial interface (UART) | 13 |
| 2.5.2 Serial peripheral interface (SPI) | 13 |
| 2.5.3 I2C interface | 13 |
| 2.5.4 I2S interface | 14 |
| 2.6 GPIO | 14 |
| 2.6.1 PWM | 15 |
| 2.7 Analog interfaces | 15 |
| 2.7.1 ADC | 15 |
| 2.7.2 Comparator | 15 |
| 2.7.3 Low power comparator | 15 |
| 2.7.4 Analog pin options | 15 |
| 2.8 u-connectXpress software features | 16 |
| 2.8.1 u-blox Serial Port Service (SPS) | 16 |
| 2.8.2 System status signals | 16 |
| 2.8.3 System control signals | 16 |

| | | |
|--------------------------|--|-----------|
| 2.8.4 | UART signals..... | 16 |
| 2.8.5 | IO signals..... | 17 |
| 2.9 | Debug interfaces..... | 17 |
| 2.9.1 | SWD..... | 17 |
| 2.9.2 | Trace – Serial Wire Viewer..... | 17 |
| 3 | Pin definition..... | 18 |
| 3.1 | Open CPU pin assignment..... | 18 |
| 3.2 | u-connectXpress pin assignment..... | 21 |
| 4 | Electrical specifications..... | 24 |
| 4.1 | Absolute maximum ratings..... | 24 |
| 4.1.1 | Maximum ESD ratings..... | 24 |
| 4.2 | Operating conditions..... | 24 |
| 4.2.1 | Operating temperature range..... | 24 |
| 4.2.2 | Supply/Power pins..... | 25 |
| 4.2.3 | Current consumption..... | 25 |
| 4.2.4 | RF performance..... | 25 |
| 4.2.5 | Throughput characteristics..... | 26 |
| 4.2.6 | Latency..... | 26 |
| 4.2.7 | ANNA-B112 radiation patterns..... | 27 |
| 4.2.8 | RESET_N pin..... | 29 |
| 4.2.9 | Digital pins..... | 29 |
| 5 | Qualifications and approvals..... | 30 |
| 5.1 | Bluetooth qualification..... | 30 |
| 6 | Mechanical specifications..... | 31 |
| 7 | Product handling..... | 32 |
| 7.1 | Packaging..... | 32 |
| 7.2 | Reels..... | 32 |
| 7.3 | Tapes..... | 33 |
| 7.4 | Moisture sensitivity levels..... | 34 |
| 7.5 | Reflow soldering..... | 34 |
| 7.6 | ESD precautions..... | 34 |
| 8 | Marking and ordering information..... | 35 |
| 8.1 | Product marking..... | 35 |
| 8.2 | Product identifiers..... | 36 |
| 8.3 | Identification codes..... | 36 |
| 8.4 | Ordering information..... | 36 |
| Appendix | | 37 |
| A | Glossary..... | 37 |
| Related documents | | 38 |
| Revision history | | 38 |
| Contact | | 39 |

1 Functional description

1.1 Overview

ANNA-B112 is an ultra-small, high-performing, standalone Bluetooth low energy module. The System-in-Package (SiP) module features Bluetooth 5, a powerful Arm® Cortex®-M4 microprocessor with FPU, with state-of-the-art power performance.

ANNA-B112 is delivered with u-connectXpress software that provides support for u-blox Bluetooth Low Energy Serial Port Service, GATT client and server, beacons, NFC™, and simultaneous peripheral and central roles – all configurable from a host by using AT commands.

The module supports two alternative antenna implementations. Utilize the integrated internal antenna together with an external antenna tuning strip, or optionally connect an external antenna to the available antenna pin during the design-in. Although the reach of external antennas can vary, the internal antenna of the module – including the external antenna strip – has a transceiver range of up to 160 m.

ANNA-B112 has full modular approval for Europe (RED), Great Britain (UKCA), US (FCC), Canada (IC / ISED RSS), Japan (MIC), Taiwan (NCC), South Korea (KCC), Australia / New Zealand (ACMA), Brazil (ANATEL), South Africa (ICASA), and China (SRRC).

1.2 Product features

| | ANNA-B112 | |
|-------------------------------------|------------|-----|
| Grade | | |
| Automotive | | |
| Professional | • | |
| Standard | | |
| Radio | | |
| Chip inside | nRF52832 | |
| Bluetooth qualification | v5.0 | |
| Bluetooth low energy | • | |
| Bluetooth output power EIRP [dBm] * | 5 / 8 | |
| Max range [meters] * | 160 / 190 | |
| NFC | • | |
| Antenna type (see footnotes) | chip / pin | |
| Application software | | |
| u-connectXpress | • | |
| Open CPU for embedded applications | | • |
| Interfaces | | |
| UART | 1 | ◆ |
| SPI | | ◆ |
| I ² C | | ◆ |
| I ² S | | ◆ |
| PDM and PWM | | ◆ |
| GPIO pins | 11 | 25 |
| AD converters [number of bits] | | 12 |
| Features | | |
| AT command interface | • | |
| MCU (see footnotes) | | M4F |
| RAM [kB] | | 64 |
| Flash [kB] | | 512 |
| Simultaneous GATT server and client | • | ◆ |
| Low Energy Serial Port Service | • | |
| Throughput [Mbit/s] | 0.8 | 1.4 |
| Maximum Bluetooth connections | 7 | 20 |
| Bluetooth mesh | | ◆ |
| FOTA | | ◆ |

* = The different values are for use with internal/external antenna

◆ = Feature enabled by HW. The actual support depends on the open CPU application SW.

pin = Antenna pin
chip = Internal chip antenna
M4F = 64 MHz Arm® Cortex-M4 with FPU

Table 1: ANNA-B112 main features summary

1.3 Block diagram

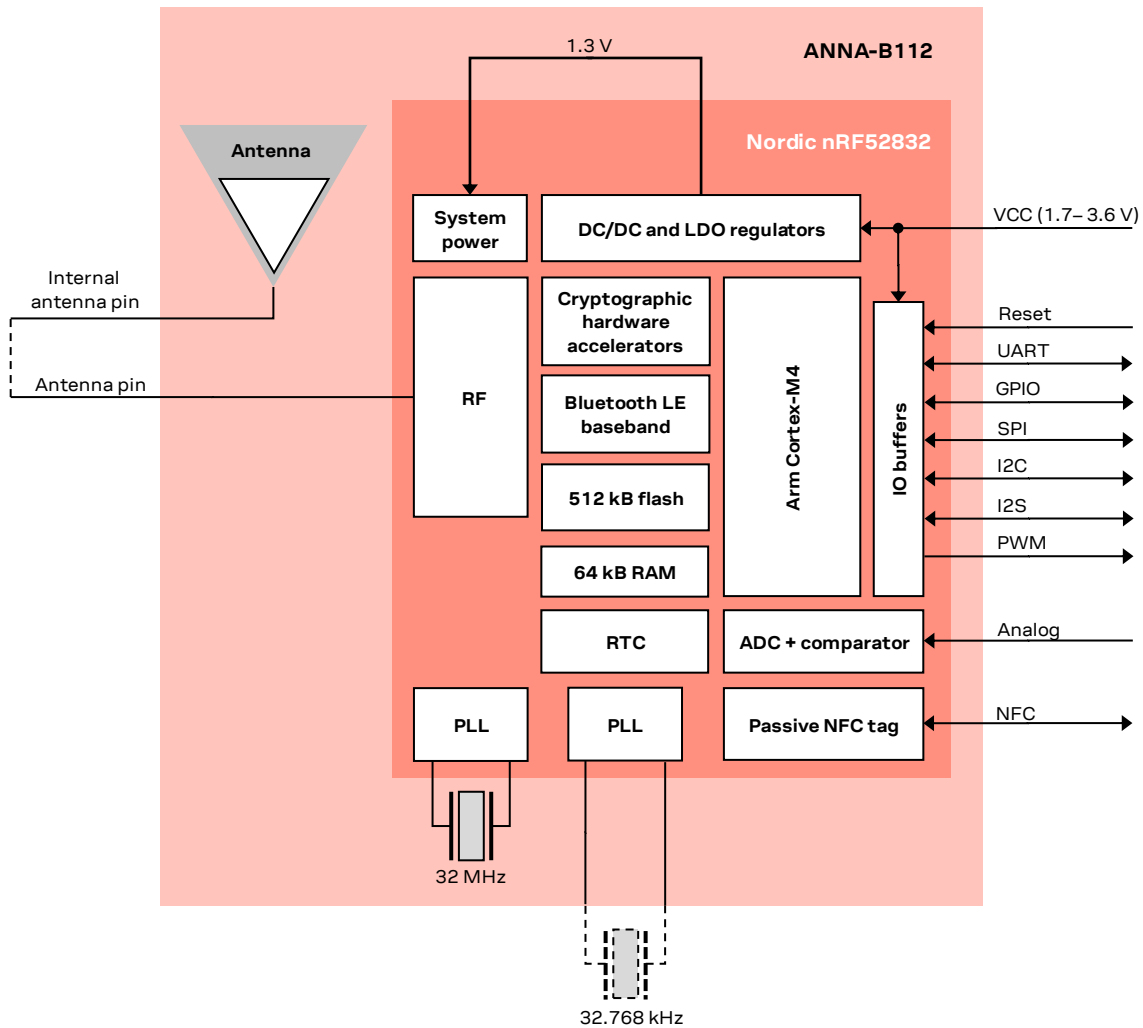

Figure 1: ANNA-B112 block diagram

The ANNA-B112 SiP module has an integrated antenna. The RF signal pin can either be connected directly to the adjacent antenna pin to use the internal antenna or routed to an external antenna or antenna connector.

The module does not have its own low power oscillator (LPO) and depending on the power supply requirement, you could connect an external LPO crystal or oscillator.

An integrated DC/DC converter is used for higher efficiency under heavy load situations. See also [Module supply input \(VCC\)](#).

1.4 Product description

| Item | ANNA-B112 |
|--|----------------------|
| Bluetooth version | 5.0 |
| Band support | 2.4 GHz, 40 channels |
| Typical conducted output power | +4 dBm |
| Max radiated output power with internal antenna (EIRP) | +5 dBm |
| Max radiated output power with external antenna (EIRP) | +9 dBm |
| Sensitivity (conducted) | -91 dBm |
| Best sensitivity with internal antenna (EIRP) | -92 dBm |
| Best sensitivity with external antenna (EIRP) | -96 dBm |
| Data rates | 1 and 2 Mbps GFSK |
| Module size | 6.5 x 6.5 x 1.2 mm |

Table 2: ANNA-B112 characteristics summary

1.5 Software options

The integrated application processor of the ANNA-B112 module is an Arm Cortex-M4 with FPU that has 512 kB flash memory and 64 kB RAM. The software structure of any program running on the module can be broken down into the following components:

- Radio stack
- Bootloader (optional)
- Application

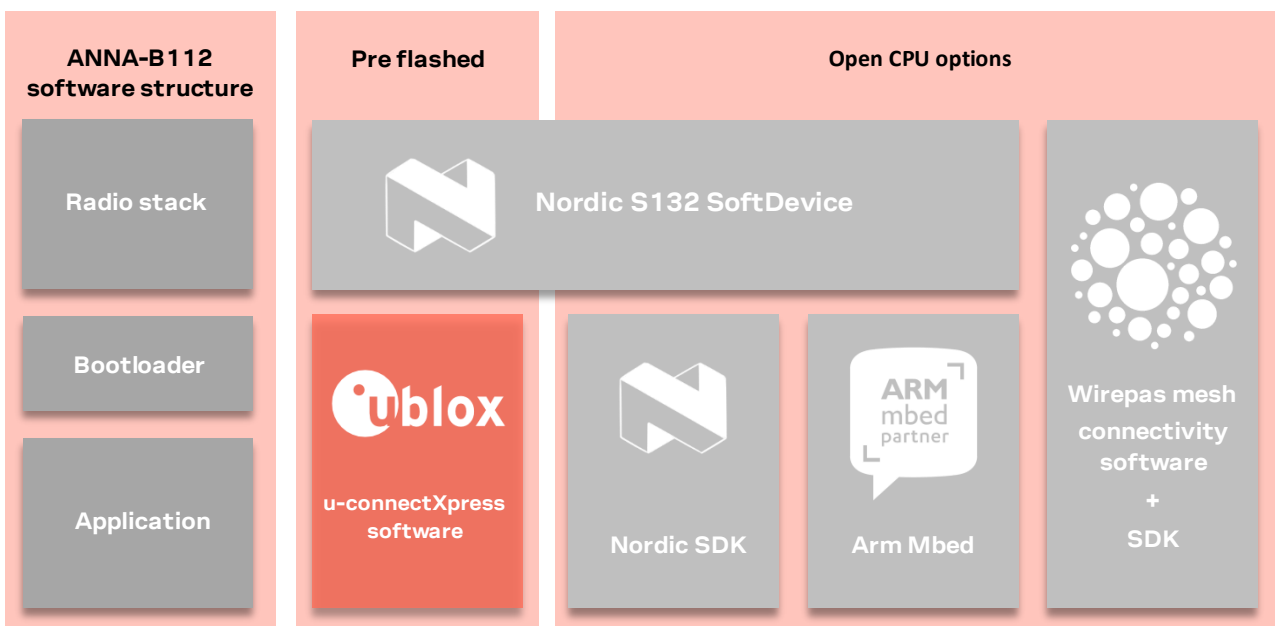

Figure 2: ANNA-B112 software structure and available software options



More information on each option, see also the ANNA-B112 system integration manual [\[1\]](#).

1.5.1 u-connectXpress software

ANNA-B1 is preflashed with u-connectXpress software.

The u-connectXpress software enables the use of the u-blox Low Energy Serial Port Service, controlled by AT commands over the UART interface. You can configure ANNA-B112 modules with AT commands or with the u-blox s-center software. The s-center evaluation software can be downloaded from the u-blox website and is available free of charge.

For information about the features, capabilities, and use of the u-blox Low Energy Serial Port Service, see also the u-connectXpress software user guide [3] and the u-connectXpress AT commands manual [2].

1.5.2 Open CPU

A custom application can be embedded in the ANNA-B112-70B module, or any ANNA-B112 variant, if the module memory is erased first. The supported development environments are described below.

nRF Connect SDK and Zephyr

The nRF Connect SDK is the most current SW development environment for nRF52-based devices. It includes a broad selection of drivers, libraries, and example applications, and is continually developed.

Nordic SDK

The Nordic nRF5 SDK provides a rich and well tested software development environment for nRF52-based devices. It includes a broad selection of drivers, libraries, and example applications.

 For new applications nRF Connect SDK and Zephyr is recommended.

Arm Mbed OS

Arm Mbed OS is an open-source, embedded operating system designed specifically for the "things" in the "Internet of Things". It includes all features to develop a connected product, including security, connectivity, an RTOS, and drivers for sensors and I/O devices. ANNA-B112 fully supports Mbed OS 5.

 For new applications nRF Connect SDK and Zephyr is recommended.

Wirepas Mesh stack

ANNA-B112 modules can also be used together with the Wirepas Mesh stack. The stack enables ANNA-B1 to be used in large-scale, mesh environments. The Wirepas mesh stack is a third-party licensed software from Wirepas.

For more information about the Wirepas mesh stack, [contact](#) your local u-blox support team or contact Wirepas directly.

1.6 Bluetooth device address

Each ANNA-B1 module is preprogrammed with a unique 48-bit Bluetooth device address.

2 Interfaces

2.1 Power management

2.1.1 Module supply input (VCC)

ANNA-B112 uses an integrated step-down converter to transform the supply voltage presented at the **VCC** pin into a stable system voltage. As a result, ANNA-B112 modules are compatible for use in battery-powered designs without the use of an additional voltage converter. You can choose one of the following board voltage converter options:

- A low-dropout (LDO) converter
- A DC/DC buck converter

ANNA-B112 automatically switches between these converters to suit the prevailing current consumption. The DC/DC converter is more efficient under high loads when the radio is active, while the LDO converter is better suited for power saving modes. It is possible to configure the module to use only the LDO mode, if needed.

2.2 RF antenna interfaces

2.2.1 2.4 GHz Bluetooth low energy (ANT)

The ANNA-B112 2.4 GHz antenna interface can be implemented in two possible ways:

- With an external antenna or antenna connector: Connect a carrier board or antenna connector to the antenna pin (**ANT**) of the module using a controlled impedance trace. The **ANT** pin has a nominal characteristic impedance of 50 Ω . For more information, see also the ANNA-B112 system integration manual [1].
- With the internal antenna: Connect the internal antenna **ANT_INT** pin to the **ANT** pin to utilize the integrated internal antenna onboard the module. Additionally, connect the **ANT_PCB**, **ANT_GND1** and **ANT_GND2** pins to an external antenna tuning strip, as described in the ANNA-B112 system integration manual [1], Appendix B.

2.2.2 Near Field Communication (NFC)

ANNA-B112 modules include a Near Field Communication interface, capable of operating as a 13.56 MHz NFC tag at a bit rate of 106 kbps. As an NFC tag, data can be read from or written to ANNA-B112 modules using an NFC reader, ANNA-B112 modules are not capable of reading other tags or initiating NFC communications. Two pins are available for connecting to an external NFC antenna: **NFC1** and **NFC2**. For more information about NFC antenna design considerations, see also the ANNA-B112 system integration manual [1].

2.3 Low Power Oscillator interface

During standby mode, ANNA-B112 needs a 32.768 kHz clock source (accuracy ± 250 ppm or better). Several clock options are available, as shown in [Table 3](#).

| Source | Current consumption | Comment |
|----------------------------------|----------------------|--|
| External 32.768kHz crystal | 300 nA | Connected to the XL1 and XL2 pins. See also Pin definition . |
| Internal RC oscillator | 620 nA + calibration | Needs recalibration every 8 s |
| External 32.768 kHz clock signal | – | Connected to the XL1 pin. See also Pin definition . |

Table 3: Supported low power clock sources for ANNA-B112

For more information about the different 32.768 kHz clock source alternatives, see also the ANNA-B112 system integration manual [1].

2.4 System functions

ANNA-B112 modules are power efficient devices capable of operating in different power saving modes and configurations. Different sections of the module can be powered off when they are not needed, and complex wake-up events can be generated from different external and internal inputs. The radio part of the module operates independently from the CPU.

The two main power saving modes are:

- Standby mode
- Sleep mode

Depending on the application, the module should spend most of its time in sleep mode to conserve battery life.

2.4.1 Module power-on

ANNA-B112 can be switched on in one of the following ways, which causes the module to reboot:

- Rising edge on the VCC pin to a valid supply voltage
- Issuing a reset of the module

A wake-up event from sleep mode to active mode can be issued by:

- Changing the state of any digital I/O pin, which may be enabled /disabled for each pin.

If waking up from standby mode, an event can also be issued by:

- The on-board Real Time Counter (RTC)
- A programmable digital or analog sensor event. For example, rising voltage level on an analog comparator pin

2.4.2 Module power-off

There is no dedicated pin to power off ANNA-B112 modules. You can configure any GPIO pin to enter or exit the [Sleep mode](#), which essentially powers down the module.

An under-voltage (brown-out) shutdown occurs on ANNA-B112 modules when the **VCC** supply drops below the operating range minimum limit. If this occurs, it is not possible to store the current parameter settings in the non-volatile memory of the module. For more information, see also the ANNA-B112 system integration manual [1].

2.4.3 Standby mode

Standby mode is one of the power saving modes that essentially powers down ANNA-B112 but keeps the system RAM intact. It allows for a few low-power digital interfaces (including SPI) and analog functions to run continuously. It also allows for complex, autonomous, power-up events, including periodic RTC events and radio events.

The following events can be used to bring the module out of the standby mode:

- External wake-up events
- Internal wake-up events from RTC, radio, NFC and so on
- Analog or digital sensor event (programmable voltage level or edge detection)

 During standby mode, the module needs a 32.768 kHz clock source. For more information about the different alternatives for the 32.768 kHz clock source, see also [Low Power Oscillator interface](#).

2.4.4 Sleep mode

Sleep mode is the deepest power saving mode of ANNA-B112 modules. During sleep mode, all functionality is stopped to ensure minimum power consumption. The module needs an external event to wake up from sleep mode.

The following events can be used to wake up the module out of the sleep mode:

- External event on a digital pin
- External event on a low power comparator pin
- Detection of NFC field

When using the u-connectXpress software, the module can be manually switched on or off with proper storage of current settings using the UART **DSR** pin.

ANNA-B112 can be programmed to latch the digital values present at its GPIO pins during sleep. The module keeps the values latched, and a change of state on any of these pins triggers a wake up to active mode.

The module always reboots after wake up from the sleep mode; however, different sections of the RAM can be configured to remain intact during and after the entry into sleep mode.

2.4.5 Module reset

ANNA-B112 modules are reset in one of the following ways:

- Applying a low logic level on the **RESET_N** input pin, which is normally pulled high using an internal pull-up resistor. This causes an “external” or “hardware” reset of the module. The prevailing parameter settings are not saved in the non-volatile module memory and a proper network detach is not performed.
- Using the `AT+CPWROFF` command to initiate an “internal” or “software” reset of the module. The current parameter settings are saved in the non-volatile module memory and a proper network detach is performed.

2.4.6 Real Time Counter (RTC)

A key system feature available on the module is the Real Time Counter. This counter can generate multiple interrupts and events to the CPU and radio as well as internal and external hardware blocks. These events can be precisely timed ranging from microseconds up to hours and allow for periodic advertising of Bluetooth LE events without involving the main CPU. The RTC can be operated in power-on and standby modes.

 During standby mode, the module needs a 32.768 kHz clock source. See also [Low Power Oscillator interface](#).

2.5 Serial interfaces

ANNA-B112 modules support the following serial communication interfaces:

- 1x UART interface: 4-wire unbalanced asynchronous serial interface used for AT commands interface, data communication and u-connectXpress software upgrades using FOTA.
- 3x SPI interfaces: Up to three serial peripheral interfaces can be used simultaneously.
- 2x I2C interfaces: Inter-Integrated Circuit (I2C) interface for communication with digital sensors.

 Radio performance parameters, such as sensitivity, can be affected by high-frequency, digital I/O signals with a large sink/source current. Consequently, all pins described as “standard-drive, low-frequency GPIO only” in [Table 7](#) should not be used for high-frequency signals.

 All digital interface pins on the module are shared between the digital and analog interfaces and GPIOs. Any function can be assigned to any pin that is not already occupied.

2.5.1 Asynchronous serial interface (UART)

The UART interface supports hardware flow control and baud-rates up to 1 Mbps. Other characteristics of the UART interface are listed below:

- Data lines (RXD as input, TXD as output) and hardware flow control lines (CTS as input, RTS as output) are provided.
- Hardware flow control (default) or no flow control is supported.
- Power saving indication available on the hardware flow control output (CTS line): The line is driven to the OFF state when the module is not ready to accept data signals.
- Programmable baud-rate generator allows most industry standard rates, as well as non-standard rates up to 1 Mbps.
- Frame format configuration:
 - 8 data bits
 - Even or no-parity bit
 - 1 stop bit
- Default frame configuration is 8N1, meaning eight (8) data bits, no (N) parity bit, and one (1) stop bit.

 Radio performance parameters, such as sensitivity, can be affected by high-frequency, digital I/O signals with a large sink/source current. Consequently, all pins described as “standard-drive, low-frequency GPIO only” in [Table 7](#) should not be used for high-frequency signals. Do not allocate these pins to the UART interface.

2.5.2 Serial peripheral interface (SPI)

ANNA-B112 supports up to three Serial Peripheral Interfaces that can operate in both master and slave mode with a maximum serial clock frequency of 8 MHz in both modes. The SPI interfaces use four signals: **SCLK**, **MOSI**, **MISO**, and **CS**. When using the SPI interface in master mode, it is possible to use GPIOs as additional Chip Select (**CS**) signals to allow addressing of multiple slaves.

 Radio performance parameters, such as sensitivity, can be affected by high-frequency, digital I/O signals with a large sink/source current. Consequently, all pins described as “standard-drive, low-frequency GPIO only” in [Table 7](#) should not be used for high-frequency signals. Do not allocate these pins to the SPI interface.

2.5.3 I2C interface

The Inter-Integrated Circuit interfaces can be used to transfer or receive data on a 2-wire bus network. ANNA-B112 modules can operate as both master and slave on the I2C bus using both standard (100 kbps) and fast (400 kbps) transmission speeds. The interface uses the **SCL** signal-to-clock instructions and data on the **SDA** signal.

 Radio performance parameters, such as sensitivity, can be affected by high-frequency, digital I/O signals with a large sink/source current. Consequently, all pins described as “standard-drive, low-frequency GPIO only” in [Table 7](#) should not be used for high-frequency signals. Do not allocate these pins to the I2C interface.

2.5.4 I2S interface

The Inter-IC Sound (I2S) interface can be used to transfer audio sample streams between ANNA-B112 and external audio devices such as codecs, DACs, and ADCs. It supports original I2S and left or right-aligned interface formats in both master and slave mode.

It uses up to five signals:

- Master clock (**MCK**)
- Left right clock or Word clock (**LRCK**)
- Serial clock (**SCK**)
- Serial data in (**SDIN**)
- Serial data out (**SDOUT**)

The Master side of the interface always provides the **LRCK** and **SCK** clock signals, but as an addition ANNA-B112 can supply a **MCK** clock signal in both master and slave mode to provide to external systems that cannot generate their own clock signal. The two data signals - **SDIN** and **SDOUT** allow for simultaneous bi-directional audio streaming. The interface supports 8, 16 and 24-bit sample widths with up to 48 kHz sample rate.

 Radio performance parameters, such as sensitivity, can be affected by high-frequency, digital I/O signals with a large sink/source current. Consequently, all pins described as “standard-drive, low-frequency GPIO only” in [Table 7](#) should not be used for high-frequency signals. Do not allocate these pins to the I2C interface.

2.6 GPIO

ANNA-B112 modules have a versatile pin-out. If left un-configured, there are 25 GPIO pins in total – with no analog or digital interfaces. All digital interfaces or functions must then be allocated to a GPIO pin before use. Eight out of the 25 GPIO pins are analog enabled and can consequently have an analog function allocated to them. [Table 4](#) shows the number of digital and analog functions that can be assigned to a GPIO pin in addition to the serial interfaces.

| Function | Description | Default ANNA pin | Configurable GPIOs |
|------------------------------|---|------------------|--------------------|
| General purpose input | Digital input with configurable edge detection and interrupt generation | | Any |
| General purpose output | Digital output with configurable drive strength, pull-up, pull-down, open-source, open-drain and/or slew rate | | Any |
| Pin disabled | Pin is disconnected from input buffers and output drivers. All* | | Any |
| Timer/ counter | High precision time measurement between two pulses/ Pulse counting with interrupt/event generation | | Any |
| Interrupt/ Event trigger | Interrupt/event trigger to the software application/ Wake up event | | Any |
| ADC input | 8/10/12-bit analog to digital converter | | Any analog |
| Analog comparator input | Compare two voltages, capable of generating wake-up events and interrupts | | Any analog |
| PWM output | Output complex pulse width modulation waveforms | | Any |
| Connection status indication | Indicates if a BLE connection is maintained | BLUE** | Any |

* = If left unconfigured

** = If using the u-connectXpress software

Table 4: GPIO custom functions configuration

 The pins dedicated to the NFC antenna function (**NFC1** and **NFC2**) have some limitation when the pins are configured for normal GPIO operation. The pin capacitance is higher on those, and you can expect some increased leakage current between the two pins if they are used in GPIO mode and are driven to different logical values. To save power, the two pins should always be set to the same logical value whenever entering one of the device power saving modes. See also [Digital pins](#).

2.6.1 PWM

ANNA-B112 modules provide up to 12 independent PWM channels that can be used to generate complex waveforms. These waveforms can be used to control motors, dim LEDs and as audio signals, if connected to speakers. Duty-cycle sequences may be stored in RAM to be chained and looped into complex sequences without CPU intervention. Each channel uses a single GPIO pin as output.

2.7 Analog interfaces

8 of the 25 digital GPIOs can be multiplexed to analog functions. The following analog functions are available for use:

- 1x 8-channel ADC
- 1x Analog comparator*
- 1x Low-power analog comparator*

*Only one of the comparators can be used simultaneously.

2.7.1 ADC

The Analog to Digital Converter (ADC) can sample up to 200 kHz using different inputs as sample triggers. It supports 8/10/12-bit resolution. Any of the 8 analog inputs can be used both as single-ended inputs and as differential pairs for measuring the voltage across them. The ADC supports full 0 V to VCC input range.

2.7.2 Comparator

The comparator compares voltages from any analog pin with different references as shown in [Table 5](#). It supports full 0 V to VCC input range and can generate different software events to the rest of the system.

2.7.3 Low power comparator

The low-power comparator operates in the same way as the normal comparator, with some reduced functionality. It can be used during sleep mode as a wake-up source.

2.7.4 Analog pin options

[Table 5](#) shows the supported connections of the analog functions.

 An analog pin may not be simultaneously connected to multiple functions.

| Analog function | Can be connected to |
|--------------------------|--|
| ADC single-ended input | Any analog pin or VCC |
| ADC differential input | Any analog pin or VCC pair |
| Comparator IN+ | Any analog pin |
| Comparator IN- | Pin 19 or 20, VCC, 1.2 V, 1.8 V, 2.4 V |
| Low-power comparator IN+ | Any analog pin |
| Low-power comparator IN- | Pin 19 or 20, 1/16 to 15/16 VCC in steps of 1/16 VCC |

Table 5: Possible uses of analog pin

2.8 u-connectXpress software features

This section describes the available features when using ANNA-B112 with u-connectXpress software. See also the u-connect AT commands manual [2].

2.8.1 u-blox Serial Port Service (SPS)

The serial port service feature enables serial port emulation over Bluetooth low energy.

2.8.2 System status signals

The **RED**, **GREEN** and **BLUE** pins are used to signal the system status according to Table 6. The pins are active low and are intended to be routed to an RGB LED.

| Mode | Status | RGB LED color | RED | GREEN | BLUE |
|-------------------------------|------------|---------------|------|-------|------|
| Data\Extended Data mode (EDM) | IDLE | Green | HIGH | LOW | HIGH |
| Command mode | IDLE | Orange | LOW | LOW | HIGH |
| EDM/Data mode, Command mode | CONNECTING | Purple | LOW | HIGH | LOW |
| EDM/Data mode, Command mode | CONNECTED* | Blue | HIGH | HIGH | LOW |

* = LED flashes on data activity

Table 6: System status indication

 CONNECTING and CONNECTED statuses indicate u-blox SPS connections.

2.8.3 System control signals

The following input signals are used to control the system:

- **RESET_N** is used to reset the system. See also [Module reset](#).
- If **SWITCH_2** is driven low during start up, the UART serial settings are restored to their default values.
- **SWITCH_2** can be used to open a Bluetooth LE connection with a peripheral device.
- If both **SWITCH_1** and **SWITCH_2** are driven low during start up, the system will enter the bootloader mode.
- If both **SWITCH_1** and **SWITCH_2** are driven low during start up and held low for 10 seconds, the system will exit the bootloader mode and restore all settings to their factory default.

2.8.4 UART signals

In addition to the normal **RXD**, **TXD**, **CTS**, and **RTS** signals, the u-connectXpress software adds the **DSR** and **DTR** pins to the UART interface. Note that they are not used as originally intended, but to control the state of the ANNA module. For example, depending on the current configuration:

The **DSR** pin can be used to:

- Enter command mode
- Disconnect and/or toggle connectable status
- Enable/disable the rest of the UART interface
- Enter/wake up from sleep mode

The **DTR** pin can be used to indicate:

- The system mode
- If the SPS peers are connected
- If a Bluetooth LE bonded device is connected
- A Bluetooth LE GAP connection

 See also the u-connect AT commands manual [2].

2.8.5 IO signals

When using the u-connectXpress software, 11 module pins can be used for manual, digital read/write operations. These pins can be configured as outputs or inputs, with or without pull-up/pull-down, using AT commands. For more information, see also the u-connect AT commands manual [2].

 In this data sheet, these signals are defined as IO signals to distinguish from the GPIO signals described in [GPIO](#). The IO signals are used with u-connectXpress software only and controlled using AT commands. The GPIO signals, representing hardware functionality, can only be used by writing a custom software application.

2.9 Debug interfaces

2.9.1 SWD

ANNA-B112 series modules provide an SWD interface for flashing and debugging. The SWD interface consists of two pins: **SWDCLK** and **SWDIO**.

2.9.2 Trace – Serial Wire Viewer

A serial trace option is also available as an additional pin: **SWO**. The Serial Wire Output is used to:

- Support printf style debugging
- Trace OS and application events
- Emit diagnostic system information

A debugger that supports Serial Wire Viewer (SWV) is required. The trace function can be used only when developing a custom application.

3 Pin definition

3.1 Open CPU pin assignment

Figure 3 shows the pin-out of the module in an unconfigured state. Alternatively, you can use the [pin assignment for u-connectXpress software](#).

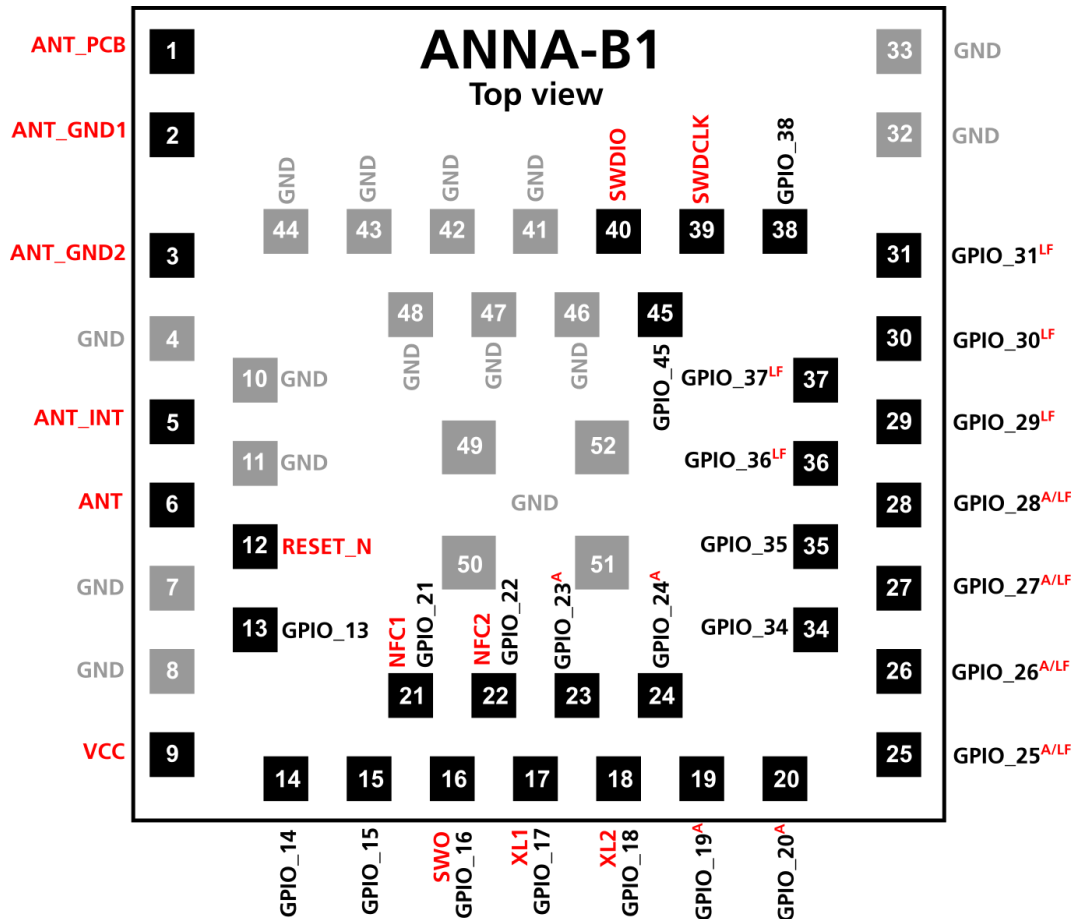

A = Analog function capable pin LF = Low Frequency, low drive I/O only
 Signals that are highlighted in red are locked to a specific pin, the grey pins are GND pins.

Figure 3: ANNA-B112 pin assignment open CPU (top view)

All digital or analog functions described in this data sheet may be freely assigned to any GPIO pin. Analog functions are limited to analog capable pins.

GPIO pins 25–31 and 36–37 are connected to pins located close to the radio part of the RF chip. It is advisable to avoid using these pins for high-speed digital interfaces or sinking/sourcing large currents through them. Doing so can adversely affect RF performance.

Do not apply an NFC field to the NFC pins when they are configured as GPIOs as it can cause permanent damage to the module. When driving different logic levels on these pins in GPIO mode, a small current leakage occurs. Ensure that they are set to the same logic level before entering any power saving modes. See also [Digital pins](#).

| No. | Name | I/O | Description | nRF52 port | Remarks |
|-------|--------------|-----|--|------------|--|
| 1 | ANT_PCB | – | Antenna pattern on carrier board if the module is mounted in a corner. | | Should only be connected if the module is mounted in a corner. See also 2.4 GHz Bluetooth Low Energy (ANT) . |
| 2 | ANT_GND1 | – | Antenna ground pattern if the module is mounted in the middle of a side. | | Should only be connected if the module is mounted in the middle of a side. See also 2.4 GHz Bluetooth Low Energy (ANT) . |
| 3 | ANT_GND2 | – | Antenna grounding if the module is mounted in the middle of a side. | | Should only be connected if the module is mounted in the middle of a side. See also 2.4 GHz Bluetooth Low Energy (ANT) . |
| 4 | GND | – | Ground | | |
| 5 | ANT_INT | – | Feeding to internal antenna of the module. | | Connect to ANT pin if the internal antenna is used. See also 2.4 GHz Bluetooth Low Energy (ANT) . |
| 6 | ANT | – | Tx/Rx antenna interface. | | 50 Ω nominal characteristic impedance. Connect to ANT pin if the internal antenna is used. See also 2.4 GHz Bluetooth Low Energy (ANT) . |
| 7–8 | GND | – | Ground | | |
| 9 | VCC | – | Module supply voltage input | | 1.7–3.6 V range |
| 10–11 | GND | – | Ground | | |
| 12 | RESET_N | I/O | System reset input | P0.21 | Active low |
| 13 | GPIO_13 | I/O | General purpose I/O | P0.14 | |
| 14 | GPIO_14 | I/O | General purpose I/O | P0.15 | |
| 15 | GPIO_15 | I/O | General purpose I/O | P0.16 | |
| 16 | SWO/GPIO_16 | I/O | Serial Wire debug trace data output | P0.18 | May be used as a GPIO |
| 17 | XL1 | I/O | Connection for 32.768 kHz crystal (LFXO) | P0.00 | If internal RC-oscillator is used, ground XL1 and XL2. |
| 18 | XL2 | I/O | Connection for 32.768 kHz crystal (LFXO) | P0.01 | If an external clock source is used instead of a crystal: <ul style="list-style-type: none"> • Apply external low swing signal to XL1, ground XL2. • Apply external full swing signal to XL1, leave XL2 grounded or unconnected. • May be used as a GPIO. |
| 19 | GPIO_19 | I/O | Analog function enabled GPIO | P0.03 | Pin is analog capable |
| 20 | GPIO_20 | I/O | Analog function enabled GPIO | P0.02 | Pin is analog capable |
| 21 | NFC1/GPIO_21 | I/O | NFC pin 1 (default) | P0.09 | May be used as a GPIO |
| 22 | NFC2/GPIO_22 | I/O | NFC pin 2 (default) | P0.10 | May be used as a GPIO |
| 23 | GPIO_23 | I/O | Analog function enabled GPIO | P0.05 | Pin is analog capable |
| 24 | GPIO_24 | I/O | Analog function enabled GPIO | P0.04 | Pin is analog capable |
| 25 | GPIO_25 | I/O | Analog function enabled GPIO | P0.31 | Pin is analog capable. Use as standard drive, low frequency GPIO only. |
| 26 | GPIO_26 | I/O | Analog function enabled GPIO | P0.30 | Pin is analog capable. Use as standard drive, low frequency GPIO only. |

| No. | Name | I/O | Description | nRF52 port | Remarks |
|-------|---------|-----|-------------------------------------|------------|--|
| 27 | GPIO_27 | I/O | Analog function enabled GPIO | P0.29 | Pin is analog capable. Use as standard drive, low frequency GPIO only. |
| 28 | GPIO_28 | I/O | Analog function enabled GPIO | P0.28 | Pin is analog capable. Use as standard drive, low frequency GPIO only. |
| 29 | GPIO_29 | I/O | General purpose I/O | P0.27 | Use as standard drive, low frequency GPIO only. |
| 30 | GPIO_30 | I/O | General purpose I/O | P0.25 | Use as standard drive, low frequency GPIO only. |
| 31 | GPIO_31 | I/O | General purpose I/O | P0.26 | Use as standard drive, low frequency GPIO only. |
| 32-33 | GND | - | Ground | | |
| 34 | GPIO_34 | I/O | General purpose I/O | P0.11 | |
| 35 | GPIO_35 | I/O | General purpose I/O | P0.19 | |
| 36 | GPIO_36 | I/O | General purpose I/O | P0.22 | Use as standard drive, low frequency GPIO only. |
| 37 | GPIO_37 | I/O | General purpose I/O | P0.23 | Use as standard drive, low frequency GPIO only. |
| 38 | GPIO_38 | I/O | General purpose I/O | P0.24 | |
| 39 | SWDCLK | I | Serial Wire Debug port clock signal | | |
| 40 | SWDIO | I/O | Serial Wire Debug port data signal | | |
| 41-44 | GND | - | Ground | | |
| 45 | GPIO_45 | I/O | General purpose I/O | P0.20 | |
| 46-48 | GND | - | Ground | | |
| 49-52 | EGP | - | Exposed Ground Pins | | The exposed pins in the center of the module should be connected to GND. |

Table 7: ANNA-B112 pin-out open CPU

3.2 u-connectXpress pin assignment

Figure 4 shows the pin-out and pin configuration for use with u-connectXpress software. The grey pins are GND pins. The function of each pin is described in Table 8.

The pin assignments are only applicable for the latest u-connectXpress software version.

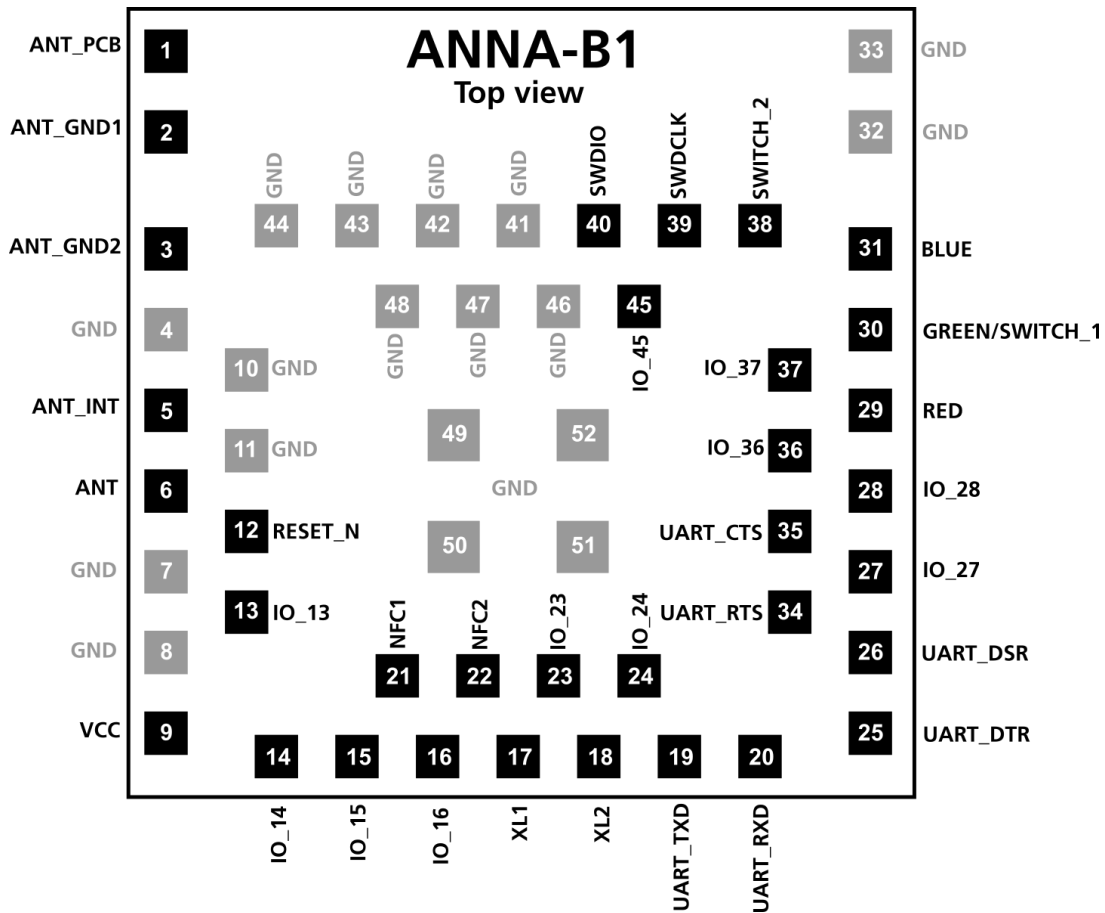

Figure 4: ANNA-B112 pin assignment (top view) applicable for u-connectXpress software

This pin layout must be followed when using u-connectXpress software. No additional interfaces can be added.

| No. | Name | I/O | Description | Remarks |
|-------|----------------|-----|---|---|
| 1 | ANT_PCB | - | Antenna pattern on carrier board if the module is mounted in a corner. | Should only be connected if the module is mounted in a corner. See also 2.4 GHz Bluetooth Low Energy (ANT) . |
| 2 | ANT_GND1 | - | Antenna ground pattern if the module is mounted in the middle of a side. | Should only be connected if the module is mounted in the middle of a side. See also 2.4 GHz Bluetooth Low Energy (ANT) . |
| 3 | ANT_GND2 | - | Antenna grounding if the module is mounted in the middle of a side. | Should only be connected if the module is mounted in the middle of a side. See also 2.4 GHz Bluetooth Low Energy (ANT) . |
| 4 | GND | - | Ground | |
| 5 | ANT_INT | - | Feeding to internal antenna of the module. | Connect to ANT pin if the internal antenna is used. See also 2.4 GHz Bluetooth Low Energy (ANT) . |
| 6 | ANT | - | Tx/Rx antenna interface. | 50 Ω nominal characteristic impedance. Connect to ANT pin if the internal antenna is used. See also 2.4 GHz Bluetooth Low Energy (ANT) . |
| 7-8 | GND | - | Ground | |
| 9 | VCC | - | Module supply voltage input | 1.7-3.6 V range. |
| 10-11 | GND | - | Ground | |
| 12 | RESET_N | I | System reset input | Active low |
| 13 | IO_13 | I/O | u-connectXpress software IO pin | Can be used for manual digital I/O |
| 14 | IO_14 | I/O | u-connectXpress software IO pin | Can be used for manual digital I/O |
| 15 | IO_15 | I/O | u-connectXpress software IO pin | Can be used for manual digital I/O |
| 16 | IO_16 | I/O | u-connectXpress software IO pin | Can be used for manual digital I/O |
| 17 | XL1 | - | Connection for 32.768 kHz crystal (LFXO) | If internal RC-oscillator is used, ground XL1 and XL2. |
| 18 | XL2 | - | Connection for 32.768 kHz crystal (LFXO) | If an external clock source is used instead of a crystal: Apply external low swing signal to XL1, ground XL2. Apply external full swing signal to XL1, leave XL2 grounded or unconnected. |
| 19 | UART_TXD | O | UART data output | |
| 20 | UART_RXD | I | UART data input | |
| 21 | NFC1 | I/O | NFC pin 1 | |
| 22 | NFC2 | I/O | NFC pin 2 | |
| 23 | IO_23 | I/O | u-connectXpress software IO pin | Can be used for manual digital I/O |
| 24 | IO_24 | I/O | u-connectXpress software IO pin | Can be used for manual digital I/O |
| 25 | UART_DTR | O | UART data terminal ready signal | Used to indicate system status |
| 26 | UART_DSR | I | UART data set ready signal | Used to change system modes |
| 27 | IO_27 | I/O | u-connectXpress software IO pin | Can be used for manual digital I/O |
| 28 | IO_28 | I/O | u-connectXpress software IO pin | Can be used for manual digital I/O |
| 29 | RED | O | RED system status signal | Active low, should be routed to an RGB LED |
| 30 | GREEN/SWITCH_1 | I/O | This signal is multiplexed: GREEN: System status signal. SWITCH_1: Multiple functions | Active low. GREEN: Should be routed to an RGB LED. SWITCH_1: See also System control signals . |
| 31 | BLUE | O | BLUE system status signal | Active low, should be routed to an RGB LED |
| 32-33 | GND | - | Ground | |

| No. | Name | I/O | Description | Remarks |
|-------|----------|-----|-------------------------------------|---|
| 34 | UART_RTS | O | UART request to send control signal | Used only when hardware flow control is enabled |
| 35 | UART_CTS | I | UART clear to send control signal | Used only when hardware flow control is enabled |
| 36 | IO_36 | I/O | u-connectXpress software IO pin | Can be used for manual digital I/O |
| 37 | IO_37 | I/O | u-connectXpress software IO pin | Can be used for manual digital I/O |
| 38 | SWITCH_2 | I | Multiple functions | Active low. See also System control signals . |
| 39 | SWDCLK | I | Serial Wire Debug port clock signal | |
| 40 | SWDIO | I/O | Serial Wire Debug port data signal | |
| 41-44 | GND | - | Ground | |
| 45 | IO_45 | I/O | u-connectXpress software IO pin | Can be used for manual digital I/O |
| 46-48 | GND | - | Ground | |
| 49-52 | EGP | - | Exposed Ground Pins | The exposed pins in the center of the module should be connected to GND |

Table 8: ANNA-B112 and u-connectXpress software pin-out

4 Electrical specifications

Stressing the device above one or more of the ratings listed in the [Absolute maximum ratings](#) can cause permanent damage. These are stress ratings only. Operating the module at these or at any conditions other than those specified in the [Operating conditions](#) should be avoided. Exposure to absolute maximum rating conditions for extended periods can affect device reliability.

All given application information is only advisory and does not form part of the specification.

4.1 Absolute maximum ratings

| Symbol | Description | Condition | Min | Max | Unit |
|--------|---------------------------|-------------------------------|------|-----|------|
| VCC | Module supply voltage | Input DC voltage at VCC pin | -0.3 | 3.9 | V |
| P_ANT | Maximum power at receiver | Input RF power at antenna pin | | +10 | dBm |

Table 9: Absolute maximum ratings

The product is not protected against overvoltage or reversed voltages. If necessary, voltage spikes exceeding the power supply voltage specification, given in table above, must be limited to values within the specified boundaries by using appropriate protection devices.

4.1.1 Maximum ESD ratings

| Parameter | Min | Typical | Max | Unit | Remarks |
|---|-----|---------|-----|------|---|
| ESD sensitivity for all pins except ANT pin | | | 2 | kV | Human body model according to JEDEC JS001 |
| | | | 500 | V | Charged device model according to JESD22-C101 |
| ESD indirect contact discharge | | | ±8* | kV | According to EN 301 489-1 |

*Tested on EVK-ANNA-B1

Table 10: Maximum ESD ratings

ANNA-B112 modules are Electrostatic Sensitive Devices and require special precautions while handling. See also [ESD precautions](#).

4.2 Operating conditions

Unless otherwise specified, all operating condition specifications are at an ambient temperature of 25°C and a supply voltage of 3.3 V.

Operation beyond the specified operating conditions is not recommended and extended exposure beyond them may affect device reliability.

4.2.1 Operating temperature range

| Parameter | Min | Max | Unit |
|-----------------------|-----|-----|------|
| Storage temperature | -40 | +85 | °C |
| Operating temperature | -40 | +85 | °C |

Table 11: Temperature range

4.2.2 Supply/Power pins

| Symbol | Parameter | Min | Typ | Max | Unit |
|------------|---|-----|-----|-----|------|
| VCC | Input supply voltage | 1.7 | 3.0 | 3.6 | V |
| t_RVCC | Supply voltage rise time | | | 60 | ms |
| VCC_ripple | VCC input noise peak to peak, 10–100 KHz | | | 100 | mV |
| | VCC input noise peak to peak, 100 KHz–1 MHz | | | 50 | mV |
| | VCC input noise peak to peak, 1–3 MHz | | | 25 | mV |

Table 12: Input characteristics of voltage supply pins

4.2.3 Current consumption

Table 13 shows the typical current consumption of the ANNA-B112 module at 3.0 V and DCDC.

| Condition | Typ | Max |
|--|--------|-----|
| No clocks running, no RAM data retention | 300 nA | |
| No clocks running, 64 kB RAM data retention | 620 nA | |
| RTC and 64 kB RAM data retention. System running on 32.768 kHz clock from crystal. | 2.2 µA | |
| CPU running benchmarking tests @ 64 MHz clock speed, all interfaces idle | 3.7 mA | |
| Radio RX only | 5.4 mA | |
| Radio TX only, +0dBm output power | 5.3 mA | |

Table 13: Module VCC current consumption

Table 14 shows the current consumption during some typical use cases when using the u-connectXpress software 2.0.0 and an external 32.768 kHz crystal – unless specified otherwise:

| Mode | Condition | 3.3 V VCC | | 1.8 V VCC | |
|---------|--|-----------|--------|-----------|--------|
| | | Average | Peak | Average | Peak |
| Active | Advertising 1s periods with +4 dBm output power and 31 bytes payload, CPU and UART interface is running | 1.3 mA | 12 mA | 1.9 mA | 20 mA |
| Standby | Advertising 1s periods with +4 dBm output power and 31 bytes payload, <i>external 32.768 kHz crystal</i> | 26 µA | 9.3 mA | 34 µA | 16 mA |
| Standby | Advertising 1s periods with +4 dBm output power and 31 bytes payload, <i>internal RC-oscillator and 4s calibration period</i> | 32 µA | 9.3 mA | 40 µA | 16 mA |
| Standby | One advertisement event (4.7 ms), +4 dBm output power and 31 bytes payload | 3.4 mA | 9.3 mA | 5.1 mA | 16 mA |
| Active | Connected as peripheral, connection events 30 ms periods, +4 dBm output power and 0 bytes payload, CPU and UART interface is running | 1.4 mA | 12 mA | 2.0 mA | 20 mA |
| Standby | Connected as peripheral, connection events 30 ms periods, +4 dBm output power and 0 bytes payload | 120 µA | 9.3 mA | 150 µA | 16 mA |
| Sleep | UART DSR pin is used to enter sleep mode. No RAM retention | 300 nA | 2.3 mA | 300 nA | 2.3 mA |

Table 14: Current consumption during typical use cases

4.2.4 RF performance

| Parameter | Test condition | Min | Typ | Max | Unit |
|----------------------------|--------------------|-----|-----|-----|------|
| Receiver input sensitivity | Conducted at 25 °C | | -91 | | dBm |
| Output power | Conducted at 25 °C | | +4 | | dBm |

Table 15: RF performance

4.2.5 Throughput characteristics

Table 16 shows some typical values for the throughput, using the u-blox SPS service, of the ANNA-B112 modules in room environment at short range. The test is performed between two ANNA-B112 modules running u-connectXpress 4.0.0.

Several connected devices reduce the throughput.

| Radio mode | Activity | Power mode | Role | Typical value (kbit/s) | | Remarks |
|--------------|-----------------------------------|------------|----------------------|------------------------|-----|--|
| Bluetooth LE | Transmitting (Simplex) | ACTIVE | Central->Peripheral | 780 | | PHY 2M, MTU 247, UART 1 Mbps, connection interval 7.5 ms |
| | Transmitting + Receiving (Duplex) | ACTIVE | Central<->Peripheral | 555 | 555 | PHY 2M, MTU 247, UART 1 Mbps, connection interval 7.5 ms |

Table 16: Throughput characteristics

4.2.6 Latency

Latency is measured with two modules connected to the same host and is calculated as the time between when the string is written to UART on module 1 and when it is read in full on UART of module 2. The string is sent between the modules over SPS.

| String length | UART speed | Connection interval | Latency (ms) | | Remarks |
|---------------|------------|---------------------|--------------|------|---------|
| | | | Median | Max | |
| 1 | 1 Mbps | 7.5 ms | 6.7 | 10.7 | MTU 247 |
| 20 | 1 Mbps | 7.5 ms | 7.4 | 11.4 | MTU 247 |
| 244 | 1 Mbps | 7.5 ms | 16.3 | 20.5 | MTU 247 |

Table 17: Approximate latency values

Latency measurements are performed in an automatic test system with a low latency host, where the UART driver latency is set to 1 ms.

4.2.7 ANNA-B112 radiation patterns

The antenna radiation test set-up utilizes the reference design and is performed with ANNA-B112 situated in the corner of the evaluation board, EVK-ANNA-B112C. For more information, see also the ANNA-B112 system integration manual [1].

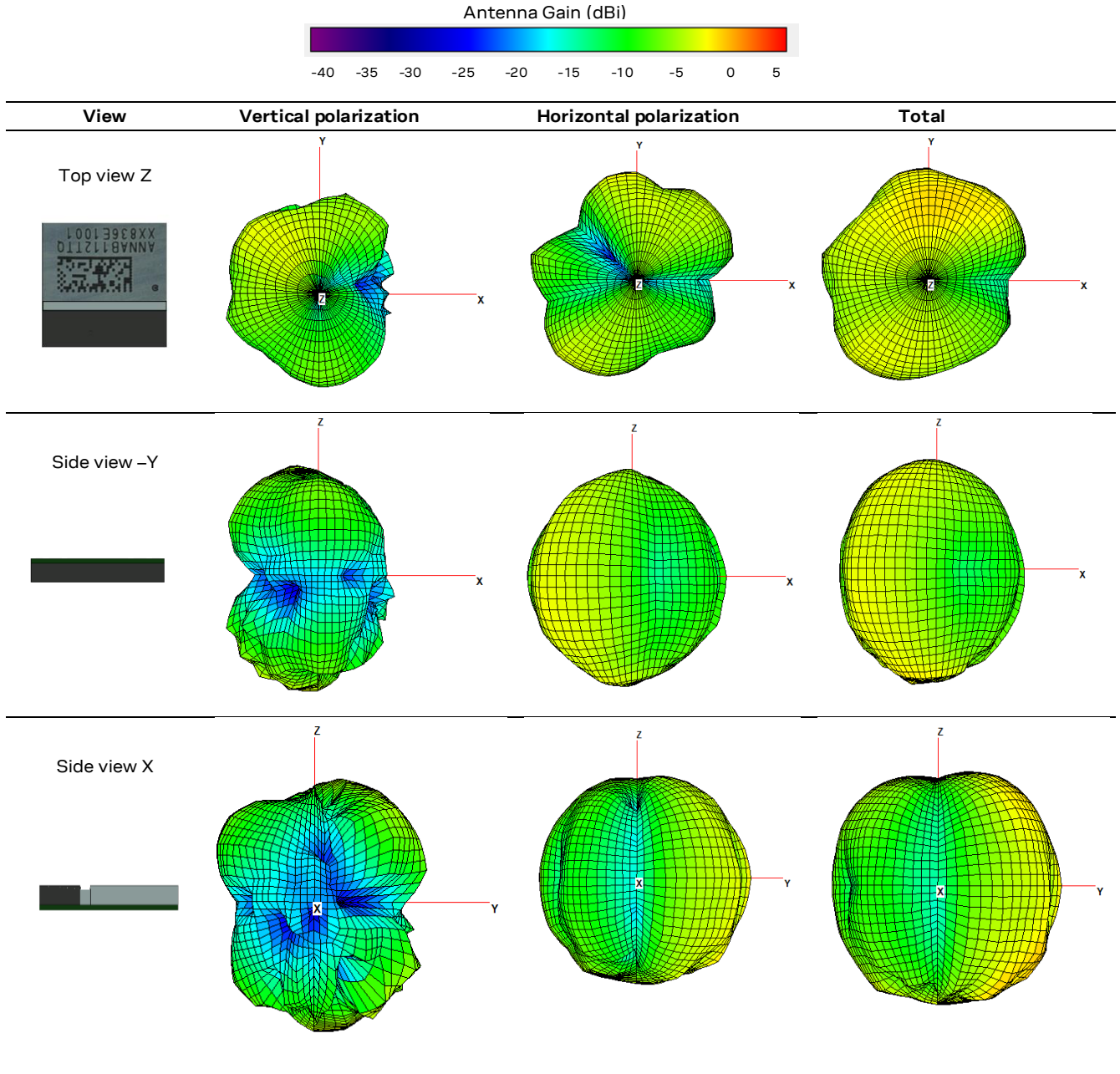

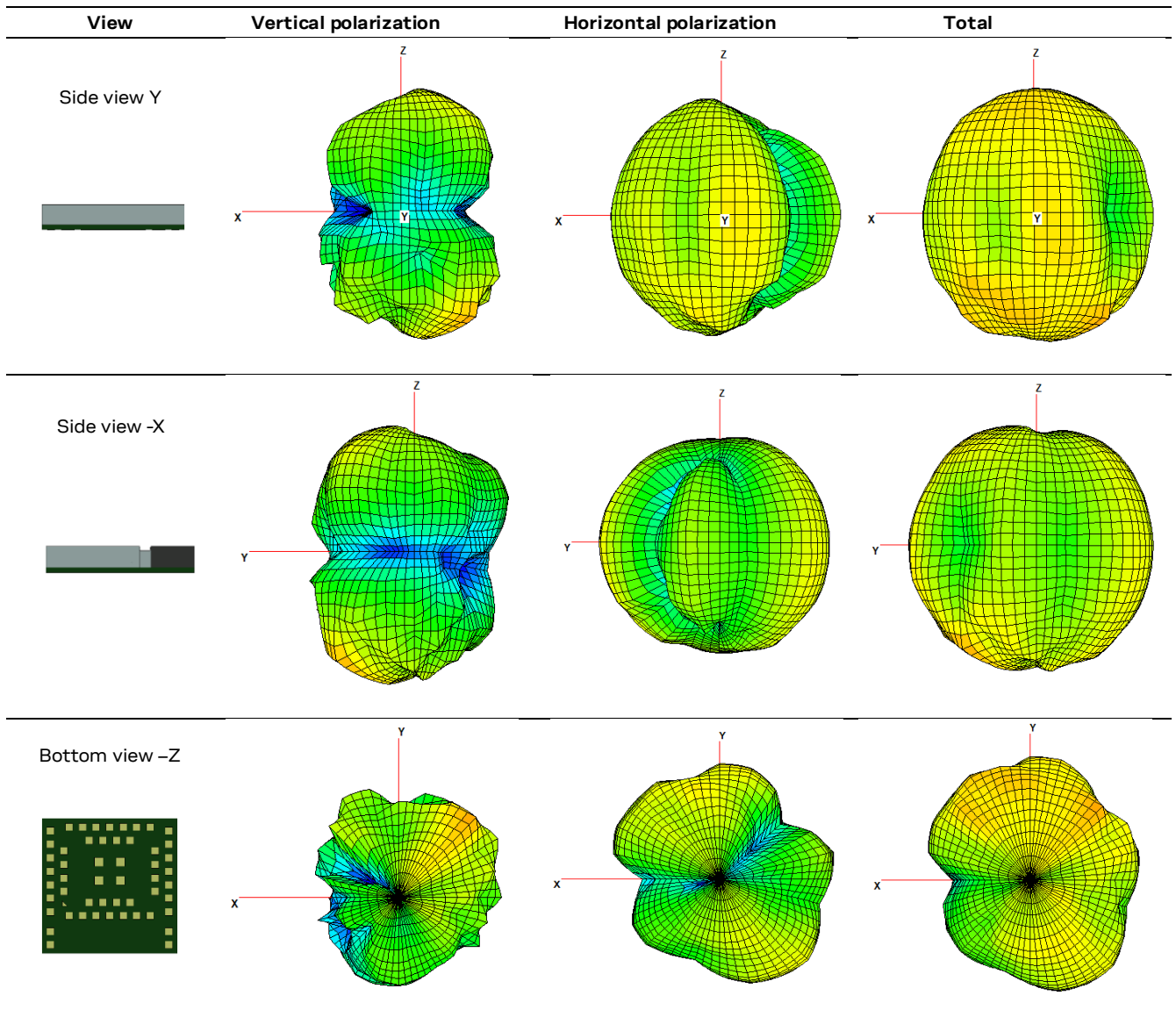

Table 18: Antenna radiation patterns

4.2.8 RESET_N pin

| Pin name | Parameter | Min | Typ | Max | Unit | Remarks |
|----------|-----------------------------|-----|-----|---------|------|------------------------------------|
| RESET_N | Low-level input | 0 | | 0.3*VCC | V | |
| | Internal pull-up resistance | | 13 | | kΩ | |
| | RESET duration | | | 55 | ms | Time taken to release a pin reset. |

Table 19: RESET_N pin characteristics

4.2.9 Digital pins

| Pin name | Parameter | Min | Typ | Max | Unit | Remarks | |
|---|---|-----|---------|---------|------|---------------------------------------|-----------------------|
| Any digital pin | Input characteristic: Low-level input | 0 | | 0.3*VCC | V | | |
| | Input characteristic: high-level input | | 0.7*VCC | VCC | V | | |
| | Output characteristic: Low-level output | | 0 | | 0.4 | V | Normal drive strength |
| | | | 0 | | 0.4 | V | High drive strength |
| | Output characteristic: High-level output | | VCC-0.4 | | VCC | V | Normal drive strength |
| | | | VCC-0.4 | | VCC | V | High drive strength |
| | Pull-up resistance | 11 | 13 | 16 | kΩ | | |
| Pull-down resistance | 11 | 13 | 16 | kΩ | | | |
| Any digital pin except IO_28 and IO_29 | Pin capacitance | | 3 | | pF | | |
| IO_28 and IO_29 | Leakage current | | 2 | 10 | μA | When driven to different logic levels | |
| | Pin capacitance | | 4 | | pF | | |

Table 20: Digital pin characteristics

5 Qualifications and approvals

ANNA-B112 modules are certified for use in the following countries/regions:

- Europe (ETSI RED)
- Great Britain (UKCA)
- US (FCC/CFR 47 part 15 unlicensed modular transmitter approval)
- Canada (IC/ISED RSS)
- Japan (MIC)
- Taiwan (NCC)
- South Korea (KCC)
- Australia / New Zealand (ACMA / RCM mark)
- Brazil (ANATEL)
- South Africa (ICASA)
- China (SRRC)

For compliance information, see the ANNA-B112 system integration manual [\[1\]](#).

5.1 Bluetooth qualification

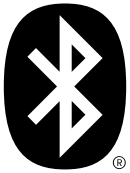

ANNA-B112 modules are qualified in accordance with Bluetooth version 5.0 specifications. For end products integrating ANNA-B112 modules used together with the pre-installed u-connectXpress software, and Open CPU configurations that use u-blox Bluetooth LE modules based on Nordic nRF5 chipsets, no further testing is required. If the End Product is to be Bluetooth listed, see the ANNA-B112 system integration manual [\[1\]](#) for further information.

6 Mechanical specifications

Figure 5 shows the mechanical outline of the ANNA-B112 package.

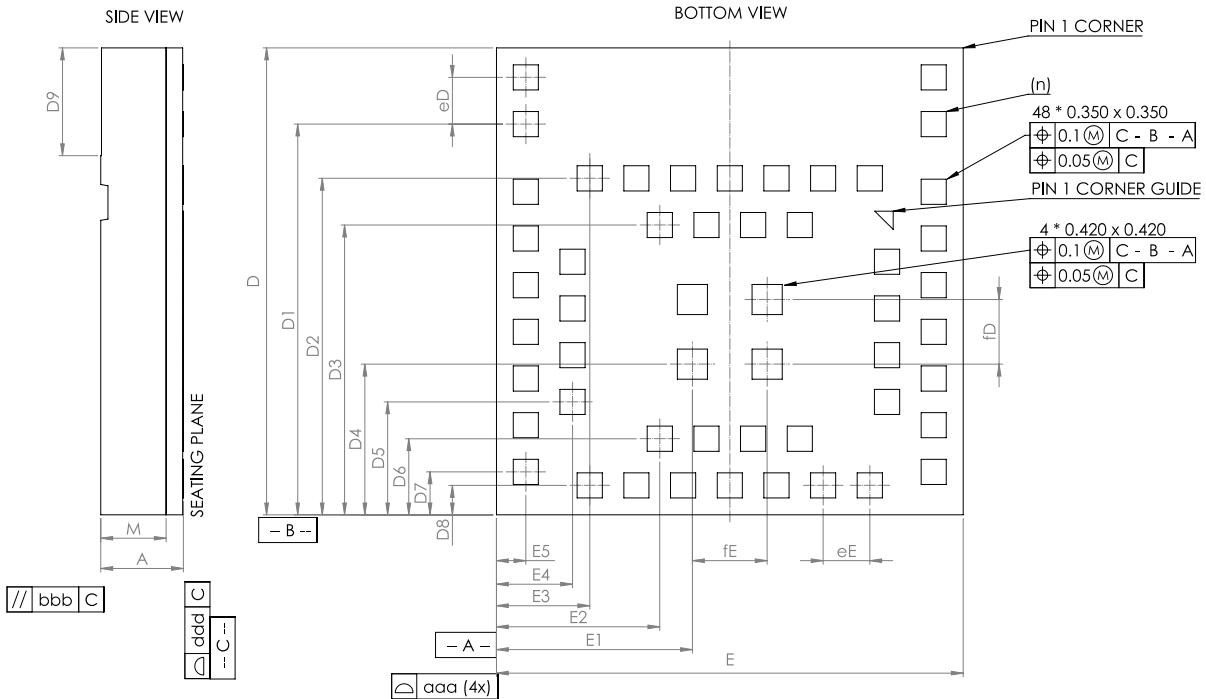

| Description | Symbol | Dimensions (mm) | Tolerance (mm) |
|------------------------|--------|-----------------|----------------|
| Package | PIM | | |
| Width | E | 6.500 | +/- 0.100 |
| Length | D | 6.500 | +/- 0.100 |
| Outer Pitch | eE | 0.650 | |
| Outer Pitch | eD | 0.650 | |
| Inner Pitch | fE | 1.040 | |
| Inner Pitch | fD | 0.900 | |
| Total thickness | A | 1.150 | +/- 0.100 |
| Mold thickness | M | 0.210 | |
| | E1 | 2.730 | |
| | E2 | 2.275 | |
| | E3 | 1.300 | |
| | E4 | 1.060 | |
| | E5 | 0.410 | |
| | D1 | 5.440 | |
| | D2 | 4.685 | |
| | D3 | 4.035 | |
| | D4 | 2.083 | |
| | D5 | 1.573 | |
| | D6 | 1.060 | |
| | D7 | 0.598 | |
| | D8 | 0.410 | |
| Antenna Area | D9 | 1.50 | |
| Lead Count | n | 52 | |
| Package Edge Tolerance | aaa | 0.100 | |
| Mold Flatness | bbb | 0.100 | |
| Coplanarity | ddd | 0.100 | |

Figure 5: ANNA-B112 mechanical specifications

7 Product handling

7.1 Packaging

ANNA-B112 modules are delivered as hermetically sealed, reeled tapes to enable efficient production, production lot setup and tear-down.

7.2 Reels

The reel types and part numbers for ANNA-B112 modules are described in [Table 21](#). See also the Product packaging guide [\[6\]](#).

| Model | Reel type | Reel part number | Qty |
|-----------|-----------|------------------|--------------|
| ANNA-B112 | F | MYR-131-BB | 500 pcs/reel |

Table 21: Reel type for ANNA-B112

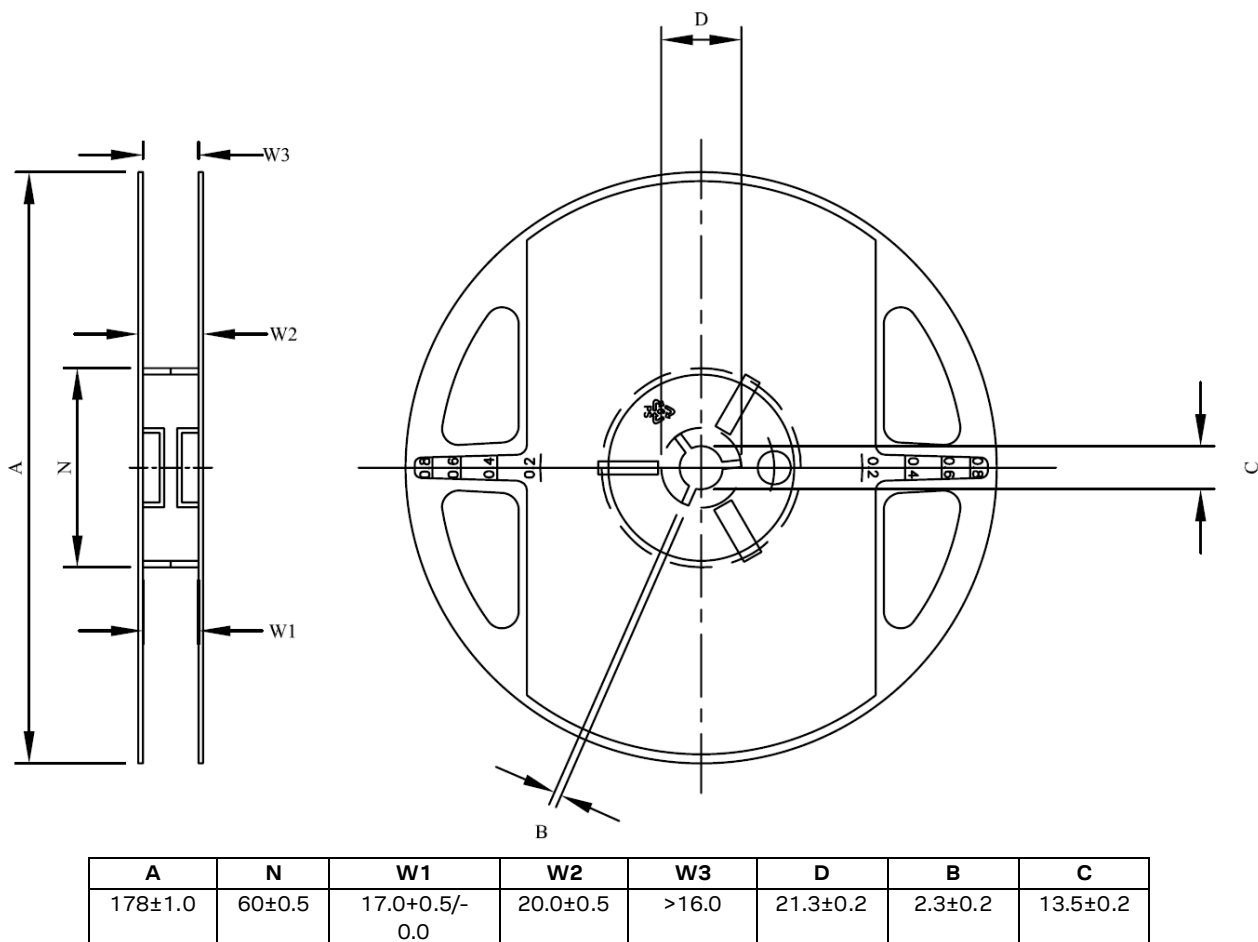

Figure 6: Seven-inch reel for ANNA-B112 modules

7.3 Tapes

Figure 7 shows the position and orientation of ANNA-B112 modules as they are delivered on tape. The dimensions of the tapes are specified in Figure 8.



Figure 7: Orientation of ANNA-B112 modules on tape

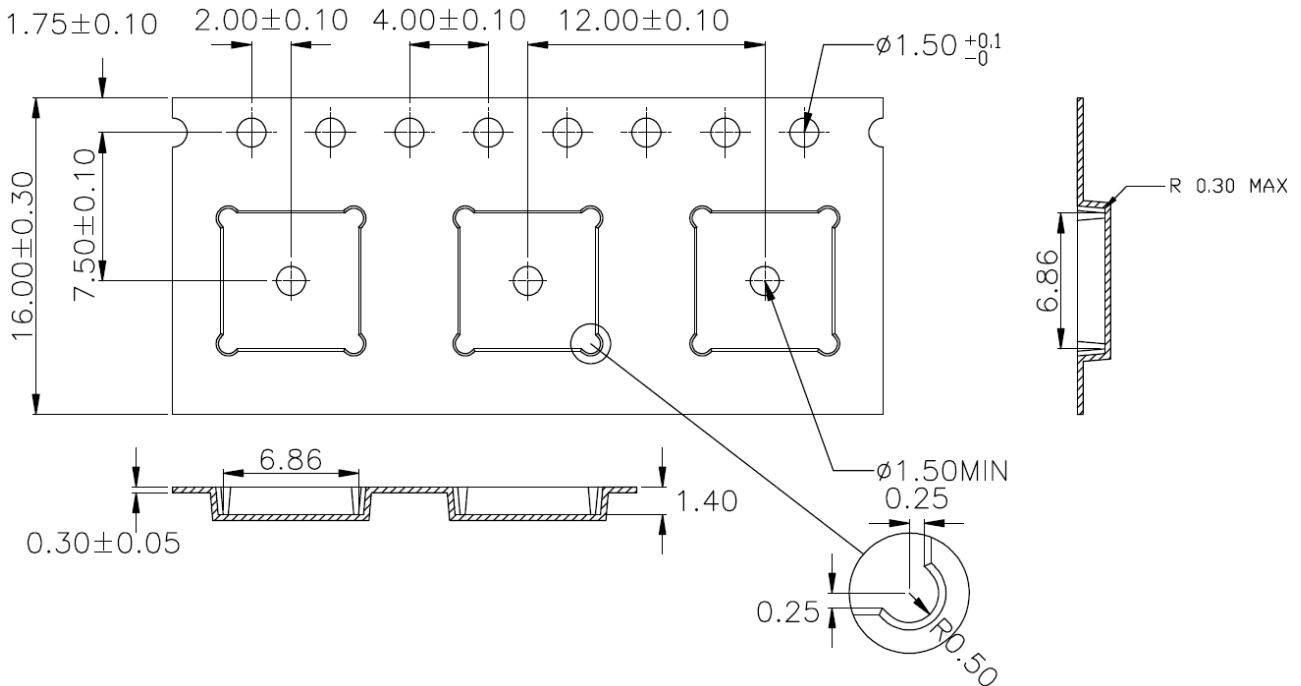



Sprocket hole pitch cumulative tolerance ± 0.20 .
 Carrier camber is within 1mm in 250 mm.
 Material: Black Conductive Polyester Allow (ABS+PS).
 All dimensions meet EIA-481-D requirements.
 Thickness: 0.30 ± 0.05 mm.
 Surface resistivity: $105 \sim 109 \Omega/\text{sq}$.

Figure 8: ANNA-B112 tape dimensions

7.4 Moisture sensitivity levels

-  ANNA-B112 modules are rated as MSL Level 3 devices in accordance with the IPC/JEDEC J-STD-020 standard. For detailed information, see the moisture sensitive warning label on the MBB (Moisture Barrier Bag).

After opening the dry pack, the modules must be mounted within 168 hours in factory conditions of maximum 30 °C/60%RH or must be stored at less than 10%RH. The modules require baking if the humidity indicator card shows more than 10% when read at 23±5 °C or if the conditions mentioned above are not met. For information about the bake procedure, see also the J-STD-033B standard.

-   For more information regarding MSL (Moisture Sensitivity Level), labeling, and storage, see also the Packaging information guide [\[6\]](#).

7.5 Reflow soldering

ANNA-B112 series modules are approved for two-time reflow processes.

-  Reflow soldering profiles must be selected in accordance with u-blox soldering recommendations described in the ANNA-B112 system integration manual [\[1\]](#). Failure to observe these recommendations can result in severe damage to the product.

7.6 ESD precautions

-  ANNA-B112 series modules are Electrostatic Sensitive Devices that demand the observance of special handling precautions against static damage. Failure to observe these precautions can result in severe damage to the product. See also [Maximum ESD ratings](#).

Proper ESD handling and packaging procedures must be applied throughout the processing, handling, and operation of any application that incorporates the ANNA-B112 module. ESD precautions are particularly relevant when handling the application board on which the module is mounted.

For further information about the handling of ANNA-B112 series modules, see also the ANNA-B112 system integration manual [\[1\]](#).

8 Marking and ordering information

8.1 Product marking

Important product and associated production data is included in a laser mark on all ANNA-B112 modules, as shown in [Figure 9](#).

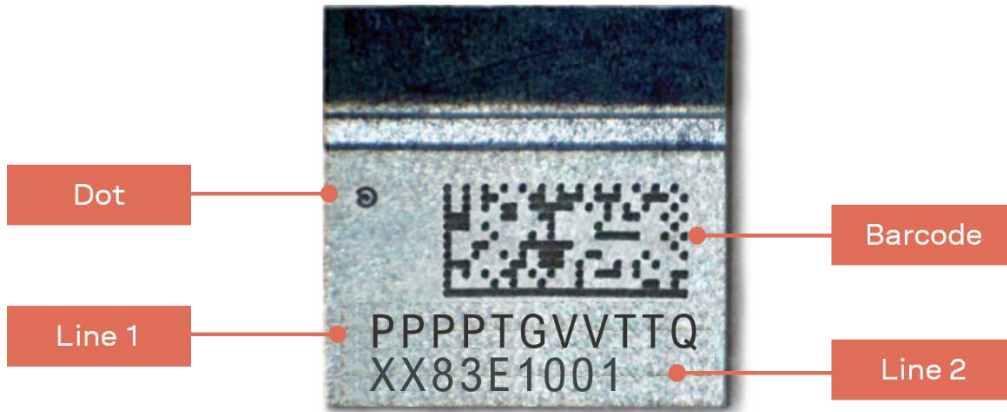

Figure 9: Product marking on the ANNA-B112 module

The product marking provides information that describes the production date, product type number, and version. The exact nomenclature of the product marking is described in [Table 22](#).

| Item | Description | Example | | | | | | | | | | | | | | | | | | | | | | | | | | | | | | | | | | | | | | | | | | | | | | | | | |
|----------------|---|----------------------------|---|---|---|---|----------|---|----|--------|----|--------|----|--------|----|----|----|------|----------------------|--|--|--|--|--|----------|--|--|--------|--|--------|--|--------|--|----------------|---|---|---|---|---|---|---|---|---|---|---|---|---|---|---|---|--|
| Dot | Pin 1 corner indication for assembly orientation. | - | | | | | | | | | | | | | | | | | | | | | | | | | | | | | | | | | | | | | | | | | | | | | | | | | |
| Line 1 | Product name, major version, and product grade ANNAB112: Product name TT = Major product version Q = Quality grade | ANNAB112 00 B | | | | | | | | | | | | | | | | | | | | | | | | | | | | | | | | | | | | | | | | | | | | | | | | | |
| Line 2 | Minor version and production date XX = Minor product version 8 = Y = Last digit of production year 36 = WW = Week number of production date E1 = EE = Assembly mother lot, last digits 001 = SSS: Assembly sub lot number | 00 8 36 E1 001 | | | | | | | | | | | | | | | | | | | | | | | | | | | | | | | | | | | | | | | | | | | | | | | | | |
| 2D code | <table border="1"> <thead> <tr> <th>1</th> <th>2</th> <th>3</th> <th>4</th> <th>5</th> <th>6</th> <th>7</th> <th>8</th> <th>9</th> <th>10</th> <th>11</th> <th>12</th> <th>13</th> <th>14</th> <th>15</th> <th>16</th> </tr> </thead> <tbody> <tr> <td>Year</td> <td colspan="6">Assembly mother lot#</td> <td colspan="3">Sub lot#</td> <td colspan="2">Strip#</td> <td colspan="2">X axis</td> <td colspan="2">Y axis</td> </tr> <tr> <td>Example</td> <td>8</td> <td>3</td> <td>6</td> <td>U</td> <td>B</td> <td>E</td> <td>1</td> <td>0</td> <td>0</td> <td>1</td> <td>0</td> <td>1</td> <td>0</td> <td>1</td> <td>0</td> <td>1</td> </tr> </tbody> </table> | 1 | 2 | 3 | 4 | 5 | 6 | 7 | 8 | 9 | 10 | 11 | 12 | 13 | 14 | 15 | 16 | Year | Assembly mother lot# | | | | | | Sub lot# | | | Strip# | | X axis | | Y axis | | Example | 8 | 3 | 6 | U | B | E | 1 | 0 | 0 | 1 | 0 | 1 | 0 | 1 | 0 | 1 | |
| 1 | 2 | 3 | 4 | 5 | 6 | 7 | 8 | 9 | 10 | 11 | 12 | 13 | 14 | 15 | 16 | | | | | | | | | | | | | | | | | | | | | | | | | | | | | | | | | | | | |
| Year | Assembly mother lot# | | | | | | Sub lot# | | | Strip# | | X axis | | Y axis | | | | | | | | | | | | | | | | | | | | | | | | | | | | | | | | | | | | | |
| Example | 8 | 3 | 6 | U | B | E | 1 | 0 | 0 | 1 | 0 | 1 | 0 | 1 | 0 | 1 | | | | | | | | | | | | | | | | | | | | | | | | | | | | | | | | | | | |

Table 22: ANNA-B112 marking description

See also

8.2 Product identifiers

Table 23 describes the three product identifiers; specifically, the Product name, Ordering code and Type number.

| Format | Description | Nomenclature |
|---------------|--|--|
| Product name | Describes the form factor, platform technology and platform variant. Used mostly in product documentation like this data sheet, the product name represents the most common identity for all u-blox products | PPPPTGVV (Line1, position 1–8) |
| Ordering code | Comprises the product name – with additional identifiers to describe the major product version and quality grade | PPPPTGVVTTQ (Line1, position 1–11) |
| Type number | Comprises the product name and ordering code – with additional identifiers to describe minor product versions. | PPPP-TGVV-TTQ-XX (Line1, position 1–11) (Line 2, position 1–2) |

Table 23: Product code formats

8.3 Identification codes

Table 24 explains the parts of the product code.

| Code | Meaning | Example |
|------|---|---|
| PPPP | Form factor | ANNA |
| TG | Platform (Technology and Generation) T – Dominant technology, For example, W: Wi-Fi, B: Bluetooth G – Generation | B1: Bluetooth Generation 1 |
| VV | Variant based on the same platform; range [00...99] | 12: default mounting, with internal antenna |
| TT | Major Product Version | 00: first revision |
| Q | Quality grade <ul style="list-style-type: none"> • A: Automotive • B: Professional • C: Standard | B: professional grade |
| XX | Minor product version (not relevant for certification) | Default value is 00 |

Table 24: Part identification code

8.4 Ordering information

| Ordering Code | Product |
|---------------|--|
| ANNA-B112-00B | ANNA-B1 module pre-flashed with u-connectXpress software v1.0.0 for optional use with either an internal or external antenna. |
| ANNA-B112-01B | ANNA-B1 module pre-flashed with u-connectXpress software v2.0.0 for optional use with either an internal antenna or an external antenna. |
| ANNA-B112-02B | ANNA-B1 module pre-flashed with u-connectXpress software v4.0.0 for optional use with either an internal antenna or an external antenna. |
| ANNA-B112-70B | ANNA-B1 module with open CPU architecture and optional use of either an internal or external antenna. |

Table 25: Product ordering codes

Appendix

A Glossary

| Abbreviation | Definition |
|--------------|---|
| ADC | Analog to digital converter |
| BLE | Bluetooth low energy |
| BPF | Band pass filter |
| CTS | Clear to send |
| ESD | Electro static discharge |
| FCC | Federal Communications Commission |
| GATT | Generic ATtribute profile |
| GPIO | General purpose input/output |
| IC | Industry Canada |
| I2C | Inter-integrated circuit |
| ICS | Inter-IC Sound |
| LPO | Low power oscillator |
| MCU | Micro controller unit |
| MSD | Moisture sensitive device |
| RF | Radio frequency |
| RTOS | Real time operating system |
| SiP | System in package |
| SPI | Serial peripheral interface |
| UART | Universal asynchronous receiver/transmitter |

Table 26: Explanation of the abbreviations and terms used

Related documents

- [1] ANNA-B112 system integration manual, [UBX-18009821](#)
- [2] u-connectXpress AT commands manual, [UBX-14044127](#)
- [3] u-connectXpress software user guide, [UBX-16024251](#)
- [4] ANNA-B112 EU declaration of conformity, [UBX-18058993](#)
- [5] ANNA-B112 UKCA declaration of conformity, [UBX-22026465](#)
- [6] Product packaging guide, [UBX-14001652](#)

 For product change notifications and regular updates of u-blox documentation, register on our website, www.u-blox.com.

Revision history

| Revision | Date | Name | Comments |
|----------|-------------|------------------|--|
| R01 | 28-Mar-2018 | mwej, kgom | Initial release. |
| R02 | 14-May-2018 | mwej, kgom | Changed product status to Engineering Sample. Updated main features summary (Table 1) and the block diagram (Figure 1). Updated the countries for modular type approvals. |
| R03 | 15-Nov-2018 | mwej, hekf, kgom | Changed product status to Initial Production. Updated RoHS compliance from RoHS 2 to RoHS 3. Inserted table of antenna radiation patterns. Updated package thickness and added missing dimensions in the mechanical drawing. Updated the number of units on a reel in section 7.2. Included information about Approved antennas. Added reference to the ANNA-B112 Getting Started Guide. Updated range figures in Table 1. Updated product marking in section 8.1. Updated information about the completed certifications for ETSI (Europe), FCC (USA), IC (Canada), Japan. Updated Tape information in section 7.3. Added Bluetooth qualification listing information i |
| R04 | 24-Dec-2018 | mwej, hekf | Added information about the completed certification for Taiwan. |
| R05 | 2-Apr-2019 | mwej, hekf | Added Hardware revision information (page 2). Updated the product ordering codes (Table 25) with software version 2.0.0 Updated Table 1. Replaced "u-blox connectivity software" with "u-connectXpress software" in all instances. Replaced all references to the "ANNA-B112 Getting Started" guide with the new document "u-connectXpress User Guide". Updated the document name of the "u-blox Short Range AT Commands Manual" to the new name - "u-connect AT Commands Manual". Added KCC to Approved antennas. Added information about the completed certification for South Korea. |
| R06 | 29-Oct-2019 | hekf | Updated Table 1. Changed the current consumption values in Table 14 and also mentioned that they are valid for u-connectXpress software version 2.0.0. Added information about the completed certification for Brazil, Australia/New Zealand and South Africa, and. Removed the mode column in Table 13 for better readability. Added information in Table 8 about grounding pins XL1 and XL2 if the internal RC-oscillator is used with the u-connectXpress software. |
| R07 | 25-Mar-2020 | hekf | Changed product status to Mass production. |
| R08 | 02-Nov-2020 | hekf | Changed ESD HBM to 2 kV, CDM to 500 V and highlighted ESD indirect contact discharge in Table 10. |
| R09 | 21-Dec-2020 | hekf | Clarified the need of antenna strips in combination with integrated antennas in sections 1.1 and 2.2. Added product description and ordering information for the ANNA-B112-70B open CPU variant in sections 1.4 and in 8.4 with associated changes in the Document information. |
| R10 | 10-Aug-21 | fkru, hisa | Added information about the completed certification for SRRC China Radio Transmission Equipment Type Approval . Added ANNA-B112-02B-00 product. Revised all document cross references and included editorial edits in all chapters. |



| Revision | Date | Name | Comments |
|----------|-------------|------------------|---|
| R11 | 02-Mar-22 | hisa, mape, hekf | Changed X and Y axis in Table 22 . Added chapters Throughput characteristics and Latency . Revised product status of ANNA-B112-02B-00 and ANNA-B112-70B-00 module variants to Mass production in Document information . Removed ambiguous description of operating condition ranges in Electrical specifications . Updated information describing Moisture sensitivity levels , Reflow soldering , and ESD precautions . Included other minor editorial changes. Reformatted Block diagram to show component boundaries more clearly. |
| R12 | 14-Mar-2023 | ctur | Reorganized Qualifications and approvals section with compliance content moved to the ANNA-B112 system integration manual [1] and rationalized information describing Bluetooth qualification . Updated Marking and ordering information . |

Contact







For further support and contact information, visit us at www.u-blox.com/support.

Looking for pricing, stock, or lifecycle information?

Click below to explore more details on WIN SOURCE:

-  [View ANNA-B112-01B on WIN SOURCE](#)
-  [U-blox Information](#)

Optimize Your Supply Chain with WIN SOURCE Solutions

-  Global Sourcing Solution
-  Obsolete Management
-  Cost Control Management
-  Shortage Management
-  Alternative Solution
-  Excess Inventory Management