



**THE DATASHEET OF  
NVT4857UKAZ**



# NVT4857UK

SD 3.0-SDR104 compliant integrated auto-direction control

Rev. 3.0 — 19 July 2023

Product data sheet

## 1 General description

---

The device is an SD 3.0-compliant bidirectional dual voltage level translator with auto-direction control. It is designed to interface between a memory card operating at 1.8 V or 3.0 V signal levels and a host with a nominal supply voltage of 1.2 V to 1.8 V.

The device supports SD 3.0 SDR104, SDR50, DDR50, SDR25, SDR12 and SD 2.0 High-Speed (50 MHz) and Default-Speed (25 MHz) modes. The device has an integrated voltage selectable low dropout regulator to supply the card-side I/Os, an auto-enable/ disable function connected to the  $V_{SD}$  supply pin, built-in EMI filters and robust ESD protections (IEC 61000-4-2, level 4).

## 2 Features and benefits

---

- Supports up to 208 MHz clock rate
- SD 3.0 specification-compliant voltage translation to support SDR104, SDR50, DDR50, SDR25, SDR12, High-Speed and Default-Speed modes
- 1.2 V to 1.8 V host side interface voltage support
- Feedback channel for clock synchronization
- 100 mA Low dropout voltage regulator to supply the card-side I/Os
- Low power consumption by push-pull output stage with break-before-make architecture
- Automatic enable and disable through  $V_{SD}$
- Integrated pull-up and pull-down resistors: no external resistors required
- Integrated EMI filters suppress higher harmonics of digital I/Os
- Integrated 8 kV ESD protection according to IEC 61000-4-2, level 4 on card side
- Level shifting buffers keep ESD stress away from the host (zero-clamping concept)
- 20-ball WLCSP; pitch 0.4 mm

## 3 Applications

---

- Smart phones
- Mobiles handsets
- Digital cameras
- Tablet PCs
- Laptop computers
- SD, MMC or microSD card readers



## 4 Ordering information

Table 1. Ordering information

Type number	Topside mark	Package		
		Name	Description	Version
NVT4857UK	N4857	WLCSP20	wafer level chip-size package; 20 bumps (5 × 4), size 1.7 x 2.1 x 0.49 mm, 0.4 mm pitch	SOT1397-10

### 4.1 Ordering options

Table 2. Ordering options

Type number	Orderable part number	Package	Packing method	Minimum order quantity	Temperature
NVT4857UK	NVT4857UKZ	WLCSP20	REEL 7" Q1/T1 *SPECIAL MARK CHIPS DP	500	T <sub>amb</sub> = -40 °C to +85 °C
NVT4857UK	NVT4857UKAZ	WLCSP20	REEL 13" Q1/T1 *SPECIAL MARK CHIPS DP	10000	T <sub>amb</sub> = -40 °C to +85 °C

5 Block diagram

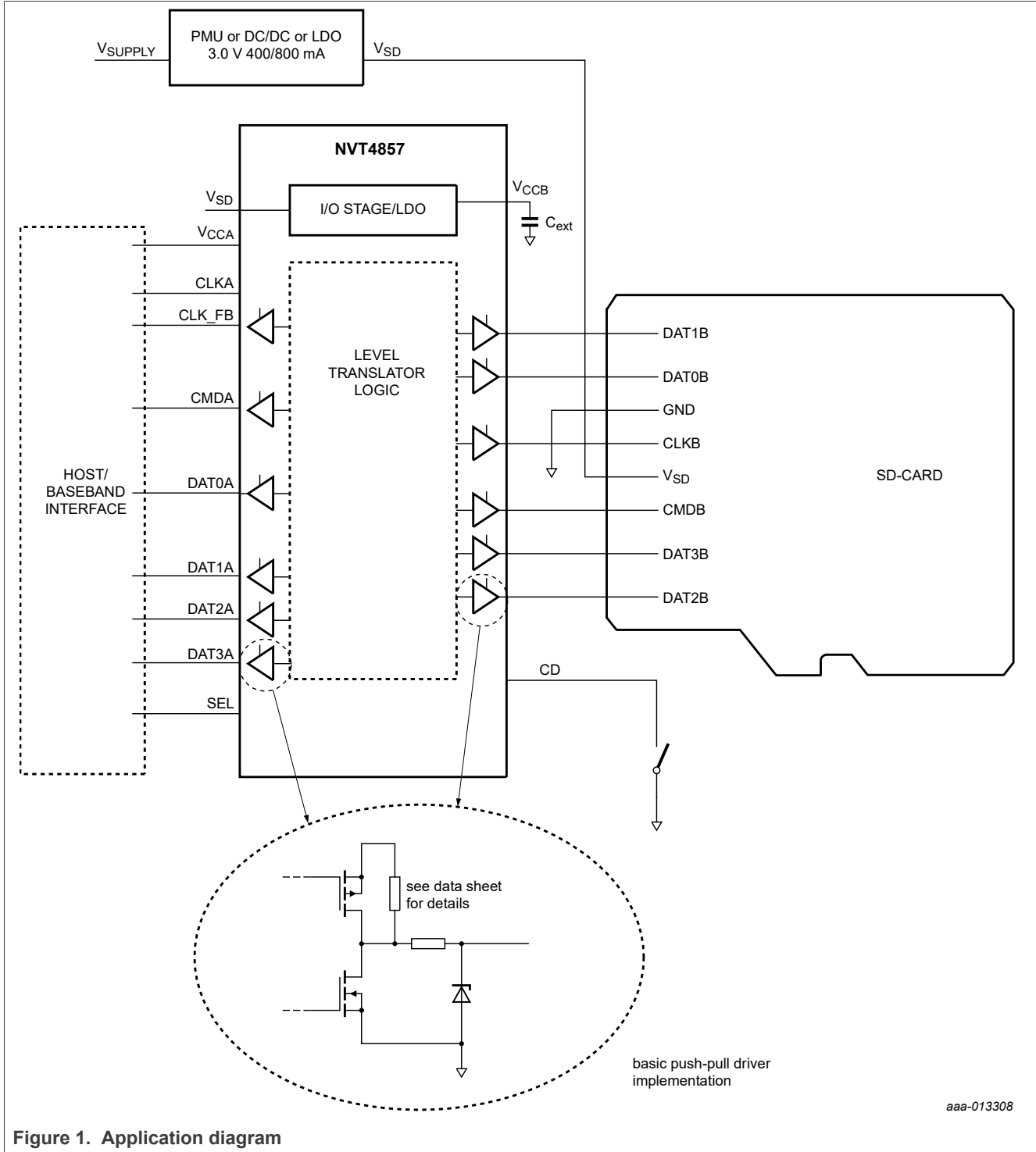

Figure 1. Application diagram

### 6 Functional diagram

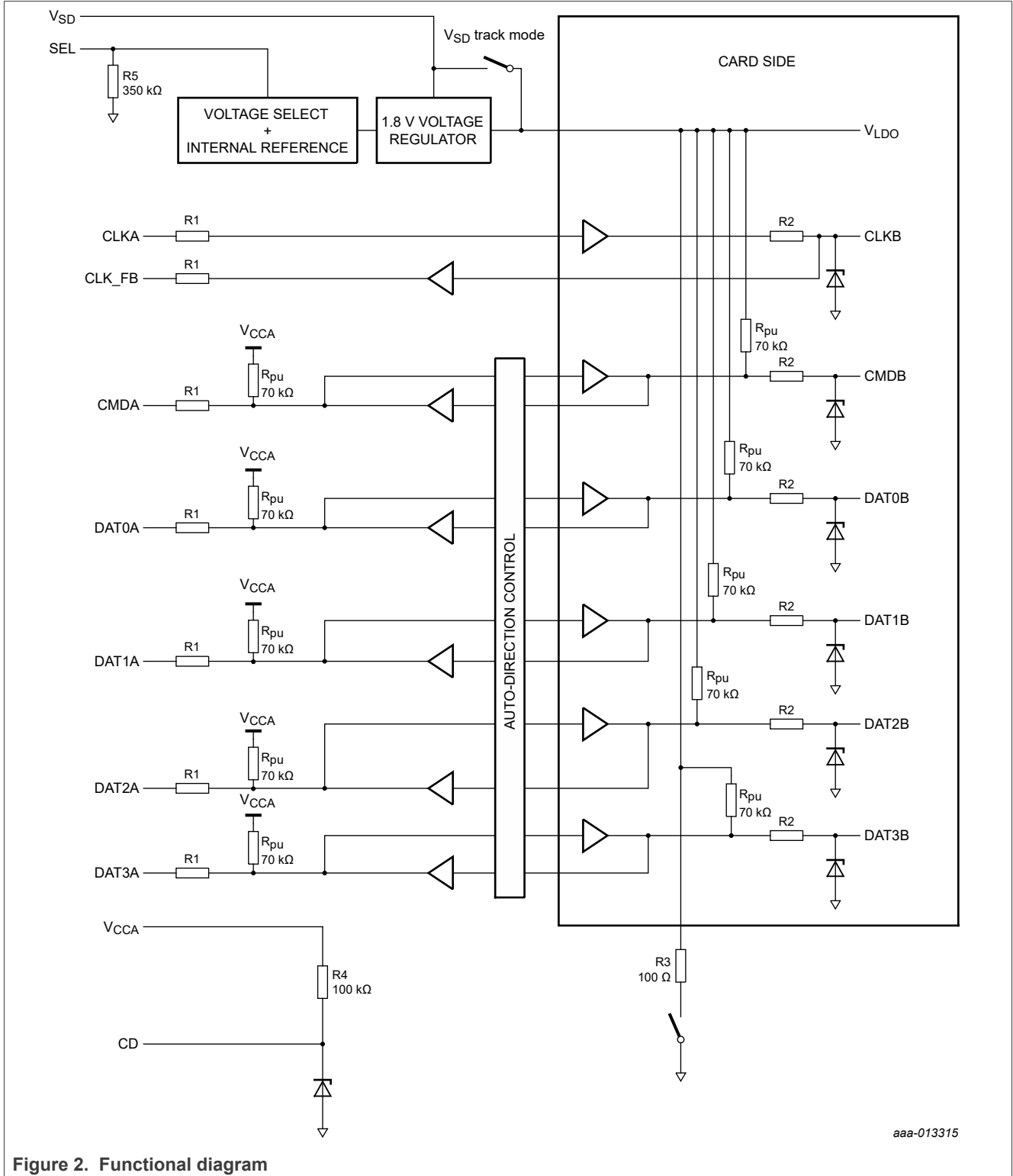

Figure 2. Functional diagram

## 7 Pinning information

### 7.1 Pinning

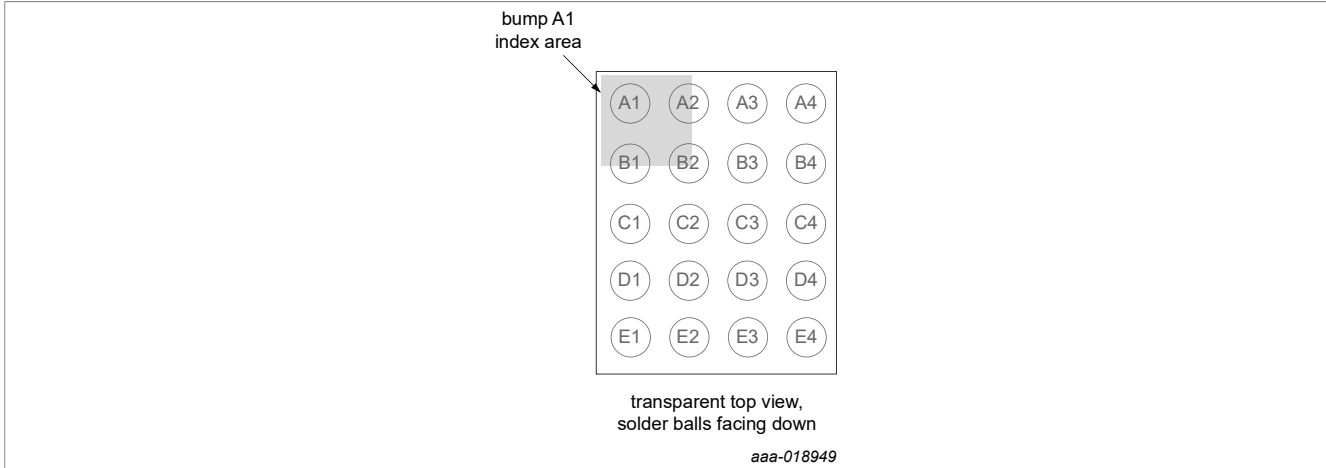

Figure 3. Pin configuration WLCSP20

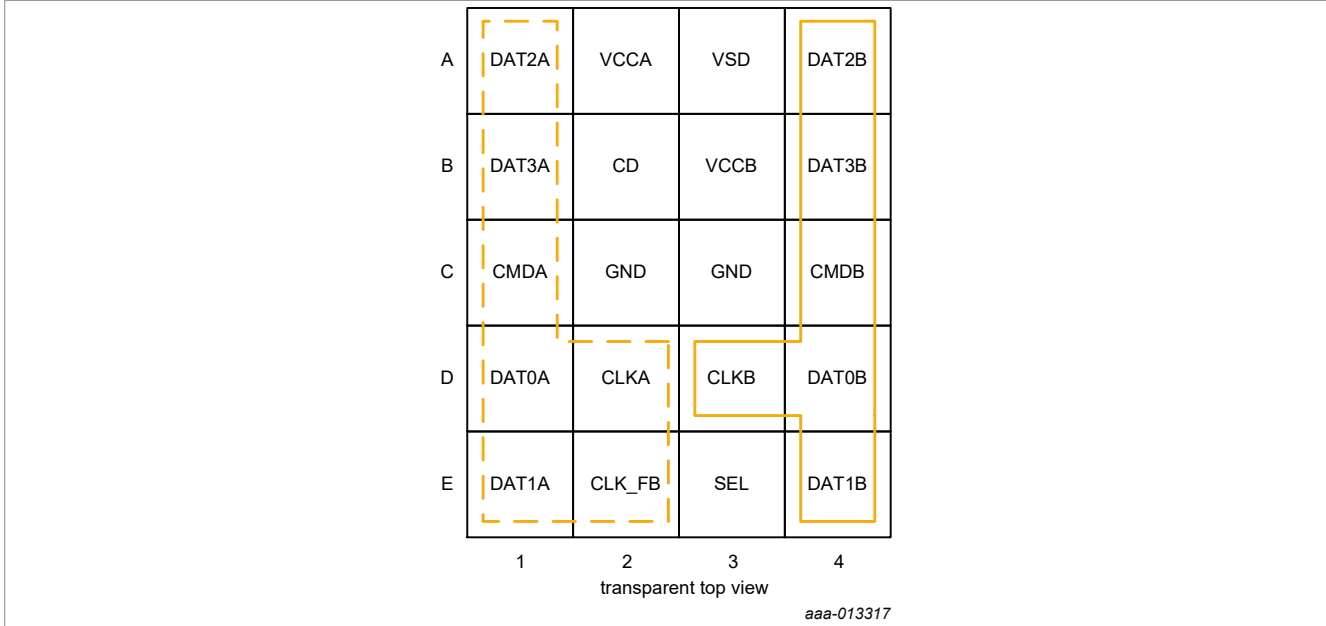

Figure 4. NVT4857UK pinout transparent top view

Table 3. Pin allocation table

Pin	Symbol	Pin	Symbol	Pin	Symbol	Pin	Symbol
A1	DAT2A	A2	V <sub>CCA</sub>	A3	V <sub>SD</sub>	A4	DAT2B
B1	DAT3A	B2	CD	B3	V <sub>CCB</sub>	B4	DAT3B
C1	CMDA	C2	GND	C3	GND	C4	CMDB
D1	DAT0A	D2	CLKA	D3	CLKB	D4	DAT0B
E1	DAT1A	E2	CLK_FB	E3	SEL	E4	DAT1B

## 7.2 Pin description

Table 4. Pin description

Symbol <sup>[1]</sup>	Pin	Type <sup>[2]</sup>	Description
DAT2A	A1	I/O	data 2 input or output on host side
V <sub>CCA</sub>	A2	S	supply voltage from host side
V <sub>SD</sub>	A3	S	supply voltage
DAT2B	A4	I/O	data 2 input or output on memory card side
DAT3A	B1	I/O	data 3 input or output on host side
CD	B2	O	card detect switch biasing output
V <sub>CCB</sub>	B3	S	internal supply decoupling (V <sub>LDO</sub> )
DAT3B	B4	I/O	data 3 input or output on memory card side
CMDA	C1	I/O	command input or output on host side
GND	C2	S	supply ground
GND	C3	S	supply ground
CMDB	C4	I/O	command input or output on memory card side
DAT0A	D1	I/O	data 0 input or output on host side
CLKA	D2	I	clock signal input on host side
CLKB	D3	O	clock signal output on memory card side
DAT0B	D4	I/O	data 0 input or output on memory card side
DAT1A	E1	I/O	data 1 input or output on host side
CLK_FB	E2	O	clock feedback output on host side
SEL	E3	I	card side I/O voltage level select
DAT1B	E4	I/O	data 1 input or output on memory card side

[1] The pin names relate particularly to SD memory cards, but also apply to microSD and MMC memory cards.

[2] I = input, O = output, I/O = input and output, S = power supply

## 8 Functional description

### 8.1 Level translator

The bidirectional level translator shifts the data between the I/O supply levels of the host and the memory card. The voltage translator has to support several clock and data transfer rates at the signaling levels specified in the SD 3.0 standard specification.

Table 5. Supported modes

Bus speed mode	Signal level (V)	Clock rate (MHz)	Data rate (MB/s)
Default-Speed	3.3	25	12.5
High-Speed	3.3	50	25
SDR12	1.8	25	12.5
SDR25	1.8	50	25
SDR50	1.8	100	50

Table 5. Supported modes...continued

Bus speed mode	Signal level (V)	Clock rate (MHz)	Data rate (MB/s)
SDR104	1.8	208	104
DDR50	1.8	50	50

### 8.2 Enable and direction control

The device contains an auto-enable feature. If  $V_{SD}$  rises above 2.65 V, the LDO and the level translator logic is enabled automatically. As soon as  $V_{SD}$  drops below the  $V_{SD\text{disable}}$ , as specified in Table 10, the LDO and the card side drivers and the level translator logic is disabled. All host side pins excluding CLKA<sup>1</sup> are configured as inputs with a 70 kΩ resistor pulled up to  $V_{CCA}$ .

### 8.3 Integrated voltage regulator

The low dropout voltage regulator delivers supply voltage for the voltage translators and the card-side input/output stages. It has to support 1.8 V and 3 V signaling modes as stipulated in the SD 3.0 specification. The switching time between the two output voltage modes is compliant with SD 3.0 specification. Depending on the signaling level at pin SEL, the regulator delivers 1.8 V (SEL = HIGH) or 3.0 V (SEL = LOW).

Table 6. SD card side voltage level control signal truth table

Input	Output		
SEL <sup>[1]</sup>	$V_{CCB}$	Pin <sup>[2]</sup>	Function
H	1.8 V	DAT0B to DAT3B, CLKB	low supply voltage level (1.8 $V_{typ}$ )
L	tracking $V_{SD}$	DAT0B to DAT3B, CLKB	high supply voltage level (tracking $V_{SD}$ )

[1] H = HIGH; L = LOW; X = don't care  
 [2] Host-side pins are not influenced by SEL.

An external capacitor is needed between the regulator output pin  $V_{CCB}$  and ground for proper operation of the integrated voltage regulator. See Table 8 for recommended capacitance and equivalent series resistance. It is recommended to place the capacitor close to the  $V_{SD}$  and  $V_{CCB}$  pin and maintain short connections of both to ground.

### 8.4 Feedback clock channel

The clock is transmitted from the host to the memory card side. The voltage translator and the Printed-Circuit Board (PCB) tracks introduce some amount of delay. It reduces timing margin for data read back from memory card, especially at higher data rates. Therefore, a feedback path is provided to compensate the delay. The reasoning behind this approach is the fact that the clock is always delivered by the host, while the data in the timing critical read mode comes from the card.

### 8.5 EMI filter

All input/output driver stages are equipped with EMI filters to reduce interferences towards sensitive mobile communication.

<sup>1</sup> CLKA is a pure high-ohmic input. Please refer to Figure 2 for more detail.

### 8.6 ESD protection

The device has robust ESD protections on all memory card pins as well as on the  $V_{SD}$  pin. The architecture prevents any stress for the host: the voltage translator discharges any stress to supply ground.

Pin Card Detection (CD) might be pulled down by the memory card which has to be detected by the host. The pin is equipped with International Electrotechnical Commission (IEC) system-level ESD protection and pull-up resistor connected to the host supply  $V_{CCA}$ .

## 9 Limiting values

Table 7. Limiting values

In accordance with the Absolute Maximum Rating System (IEC 60134).

Symbol	Parameter	Conditions	Min	Max	Unit
$V_{CC}$	supply voltage	4 ms transient			
		on pin $V_{SD}$	-0.5	+4.6	V
		on pin $V_{CCA}$	-0.5	+4.6	V
$V_I$	input voltage	4 ms transient at I/O pins	-0.5	+4.6	V
$P_{tot}$	total power dissipation	$T_{amb} = -40\text{ °C to }+85\text{ °C}$	-	1000	mW
$T_{stg}$	storage temperature		-55	+150	°C
$T_{amb}$	ambient temperature		-40	+85	°C
$V_{ESD}$	electrostatic discharge voltage	IEC 61000-4-2, level 4, all memory card-side pins, $V_{SD}$ and CD to ground	[1]		
		contact discharge	-8	+8	kV
		air discharge	-15	+15	kV
		Human Body Model (HBM) JEDEC JESD22-A114 F; all pins	-2000	+2000	V
		Charge Device Model (CDM) JEDEC JESD22-C101E; all pins	-500	+500	V
$I_{lu(I/O)}$	input/output latch-up current	JESD 78B: $-0.5 \times V_{CC} < V_I < 1.5 \times V_{CC}$ ; $T_j < 125\text{ °C}$	-100	+100	mA

[1] All system level tests are performed with the application-specific capacitors connected to the supply pins  $V_{SUPPLY}$ ,  $V_{LDO}$  and  $V_{CCA}$ .

## 10 Recommended operating conditions

Table 8. Operating conditions

Symbol	Parameter	Conditions	Min	Typ	Max	Unit
$V_{CC}$	supply voltage	on pin $V_{SD}$	[1] 2.9	-	3.6	V
		on pin $V_{CCA}$	1.1	-	2.0	V
$V_I$	input voltage	host side	[2] -0.3	-	$V_{CCA} + 0.3$	V
		memory card side	-0.3	-	$V_{O(LDO)} + 0.3$	V
$C_{ext}$	external capacitance	recommended capacitor at pin $V_{CCB}$	-	2.2	-	µF
ESR	equivalent series resistance	at pin $V_{LDO}$	0	-	50	mΩ

Table 8. Operating conditions...continued

Symbol	Parameter	Conditions	Min	Typ	Max	Unit
C <sub>ext</sub>	external capacitance	recommended capacitor at pin V <sub>SD</sub>	-	0.1	-	μF
		recommended capacitor at pin V <sub>CCA</sub>	-	0.1	-	μF

[1] By minimum value the device is still fully functional, but the voltage on pin V<sub>LDO</sub> might drop below the recommended memory card supply voltage.  
 [2] The voltage must not exceed 3.6 V.

Table 9. Integrated resistors

T<sub>amb</sub> = 25 °C; unless otherwise specified.

Symbol	Parameter	Conditions	Min	Typ	Max	Unit	
R <sub>pd</sub>	pull-down resistance	R3; tolerance ±30 %		70	100	130	Ω
		R5		200	350	500	kΩ
R <sub>pu</sub>	pull-up resistance	all data lines and CMDx		49	70	91	kΩ
		R4		70	100	130	kΩ
R <sub>s</sub>	series resistance	host side; R1; tolerance ±30 %	[1]	-	22.5	-	Ω
		card side; R2; tolerance ±30 %	[1]	-	15	-	Ω

[1] Guaranteed by design.

## 11 Static characteristics

Table 10. Static characteristics

At recommended operating conditions; T<sub>amb</sub> = -40 °C to +85 °C; voltages are referenced to GND (ground = 0 V); C<sub>ext</sub> = 2.2 μF at pin V<sub>CCB</sub>; guaranteed by design and characterization; unless otherwise specified.

Symbol	Parameter	Conditions	Min	Typ <sup>[1]</sup>	Max	Unit
<b>Automatic enable feature: V<sub>SD</sub></b>						
V <sub>SDen</sub>	device enable voltage level	V <sub>CCA</sub> ≥ 1.0 V, V <sub>SD</sub> rising edge	2.25	2.45	2.65	V
V <sub>SDdisable</sub>	device disable voltage level	V <sub>CCA</sub> ≥ 1.0 V, V <sub>SD</sub> falling edge	2.2	2.4	2.6	V
ΔV <sub>SDen</sub>	V <sub>SDen</sub> hysteresis voltage		-	50	-	mV
<b>Supply voltage regulator for card-side I/O pin: V<sub>CCB</sub></b>						
V <sub>O(LDO)</sub>	regulator/switch output voltage	SEL = LOW; 3.0 V ≤ V <sub>SD</sub> ≤ 3.6 V; I <sub>O</sub> < 100 mA	V <sub>SD</sub> -0.2	V <sub>SD</sub> -0.1	V <sub>SD</sub>	V
		SEL = HIGH; V <sub>SD</sub> ≥ 2.9 V; I <sub>O</sub> < 100 mA	1.7	1.8	1.95	V
I <sub>O(LDO)</sub>	regulator/switch output current		-	-	100	mA
<b>Host-side input signals: CMDA and DAT0A to DAT3A, CLKA; 1.1 V ≤ V<sub>CCA</sub> ≤ 2.0 V</b>						
V <sub>IH</sub>	HIGH-level input voltage		0.75 × V <sub>CCA</sub>	-	V <sub>CCA</sub> + 0.3	V
V <sub>IL</sub>	LOW-level input voltage		-0.3	-	0.25 × V <sub>CCA</sub>	V
<b>Host-side control signals; 1.1 V ≤ V<sub>CCA</sub> ≤ 2.0 V</b>						
SEL						

SD 3.0-SDR104 compliant integrated auto-direction control

**Table 10. Static characteristics...continued**

At recommended operating conditions;  $T_{amb} = -40\text{ °C to }+85\text{ °C}$ ; voltages are referenced to GND (ground = 0 V);  $C_{ext} = 2.2\text{ }\mu\text{F}$  at pin  $V_{CCB}$ ; guaranteed by design and characterization; unless otherwise specified.

Symbol	Parameter	Conditions	Min	Typ <sup>[1]</sup>	Max	Unit
$V_{IH}$	HIGH-level input voltage		$0.75 \times V_{CCA}$	-	$V_{CCA} + 0.3$	V
$V_{IL}$	LOW-level input voltage		-0.3	-	$0.25 \times V_{CCA}$	V
<b>Host-side output signals: CLK_FB, CMDA and DAT0A to DAT3A; <math>1.1\text{ V} \leq V_{CCA} \leq 2.0\text{ V}</math></b>						
$V_{OH}$	HIGH-level output voltage for CLK_FB	$I_O = 2\text{ mA}$ ; $V_I = V_{IH}$ (card side)	$0.8 \times V_{CCA}$	-	-	V
	HIGH-level output voltage for CMDA, DATxA	$I_O = 2\text{ }\mu\text{A}$ ; $V_I = V_{IH}$ (card side)	$0.8 \times V_{CCA}$	-	-	V
$V_{OL}$	LOW-level output voltage	$I_O = -2\text{ mA}$ ; $V_I = V_{IL}$ (card side)	-	-	$0.15 \times V_{CCA}$	V
<b>Card-side input signals: CMDB and DAT0B to DAT3B</b>						
$V_{IH}$	HIGH-level input voltage	SEL = LOW (3.0 V card interface)	$0.625 \times V_{O(LDO)}$	-	$V_{O(LDO)} + 0.3$	V
		SEL = HIGH (1.8 V card interface)	$0.625 \times V_{O(LDO)}$	-	$V_{O(LDO)} + 0.3$	V
$V_{IL}$	LOW-level input voltage	SEL = LOW (3.0 V card interface)	-0.3	-	$0.3 \times V_{O(LDO)}$	V
		SEL = HIGH (1.8 V card interface)	-0.3	-	$0.35 \times V_{O(LDO)}$	V
<b>Card-side output signal</b>						
CMDB and DAT0B to DAT3B, CLKB						
$V_{OH}$	HIGH-level output voltage for CLKB only	$I_O = 4\text{ mA}$ ; $V_I = V_{IH}$ (host side); SEL = LOW (3.0 V card interface)	$0.85 \times V_{O(LDO)}$	-	$V_{O(LDO)} + 0.3$	V
		$I_O = 2\text{ mA}$ ; $V_I = V_{IH}$ (host side); SEL = HIGH (1.8 V card interface)	$0.85 \times V_{O(LDO)}$	-	2.0	V
	HIGH-level output voltage for CMDB, DATxB	$I_O = 2\text{ }\mu\text{A}$ ; $V_I = V_{IH}$ (host side); SEL = HIGH (1.8 V card interface)	$0.85 \times V_{O(LDO)}$	-	2.0	V
$V_{OL}$	LOW-level output voltage	$I_O = -4\text{ mA}$ ; $V_I = V_{IL}$ (host side); SEL = LOW (2.9 V card interface)	-0.3	-	$0.125 \times V_{O(LDO)}$	V
		$I_O = -2\text{ mA}$ ; $V_I = V_{I\text{ card L}}$ (host side); SEL = HIGH (1.8 V interface)	-0.3	-	$0.125 \times V_{O(LDO)}$	V
Pin capacitance						
$C_{io}$	input/output capacitance	host side	-	2	4	pF
		card side	-	6	9	pF
<b>Current consumption</b>						
$I_{CC(stat)}$	static supply current	$V_{SD} \geq V_{SDen}$ (active mode); all inputs = HIGH;				
		SEL = LOW (3.0 V card interface)	-	-	100	$\mu\text{A}$
		SEL = HIGH (1.8 V card interface)	-	-	100	$\mu\text{A}$

**Table 10. Static characteristics...continued**

At recommended operating conditions;  $T_{amb} = -40\text{ }^{\circ}\text{C}$  to  $+85\text{ }^{\circ}\text{C}$ ; voltages are referenced to GND (ground = 0 V);  $C_{ext} = 2.2\text{ }\mu\text{F}$  at pin  $V_{CCB}$ ; guaranteed by design and characterization; unless otherwise specified.

Symbol	Parameter	Conditions	Min	Typ <sup>[1]</sup>	Max	Unit
$I_{CC(stb)}$	standby supply current	$V_{SD} \leq V_{SDen}$ and $V_{CCA} \geq 1.0\text{ V}$ (inactive mode); all host side inputs = HIGH	-	-	7	$\mu\text{A}$

[1] Typical values are measured at  $T_{amb} = 25\text{ }^{\circ}\text{C}$ .

## 12 Dynamic characteristics

### 12.1 Voltage regulator

**Table 11. Voltage regulator**

$T_{amb} = 25\text{ }^{\circ}\text{C}$ ; unless otherwise specified.

Symbol	Parameter	Conditions	Min	Typ	Max	Unit
<b>Voltage regulator output pin: <math>V_{CCB}</math></b>						
$t_{startup(LDO)}$	regulator start-up time	$V_{CCA} = 1.8\text{ V}$ ; $V_{SD} = 3.0\text{ V}$ ; $C_{ext} = 2.2\text{ }\mu\text{F}$ ; see <a href="#">Figure 6</a>	-	-	400	$\mu\text{s}$
$t_{f(o)}$	output fall time	$V_{O(LDO)} = 3.0\text{ V}$ to $1.8\text{ V}$ ; SEL = LOW to HIGH; see <a href="#">Figure 5</a>	-	-	1	ms
$t_{r(o)}$	output rise time	$V_{O(LDO)} = 1.8\text{ V}$ to $3.0\text{ V}$ ; SEL = HIGH to LOW; see <a href="#">Figure 5</a>	-	-	100	$\mu\text{s}$

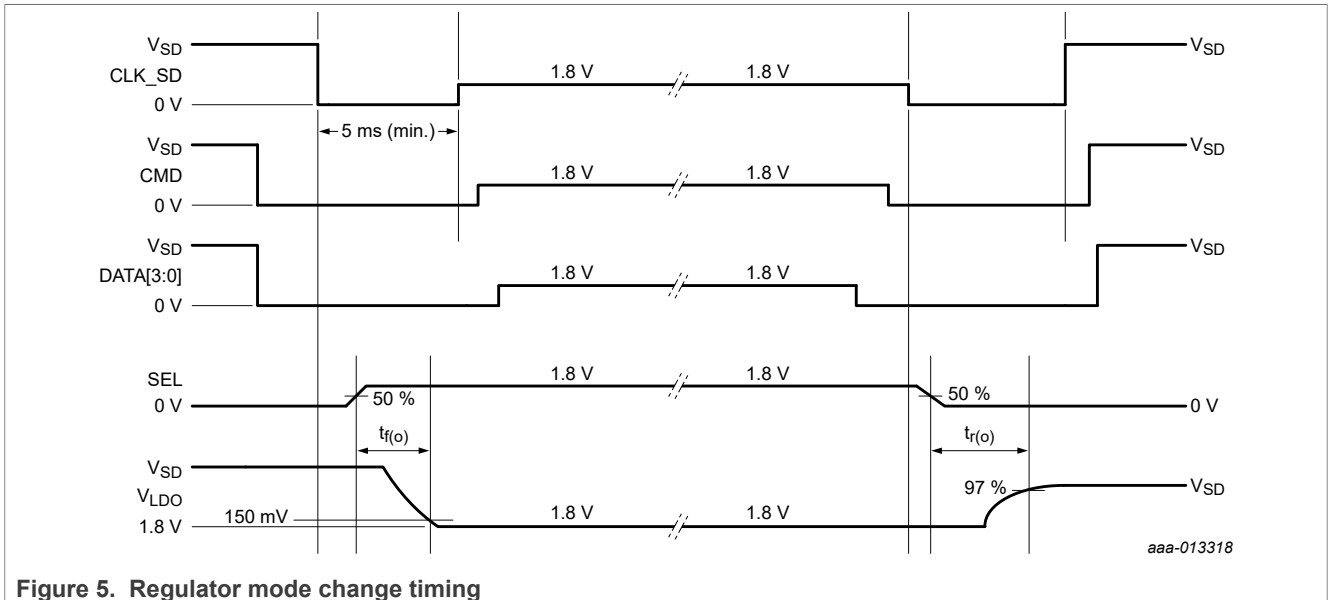

**Figure 5. Regulator mode change timing**

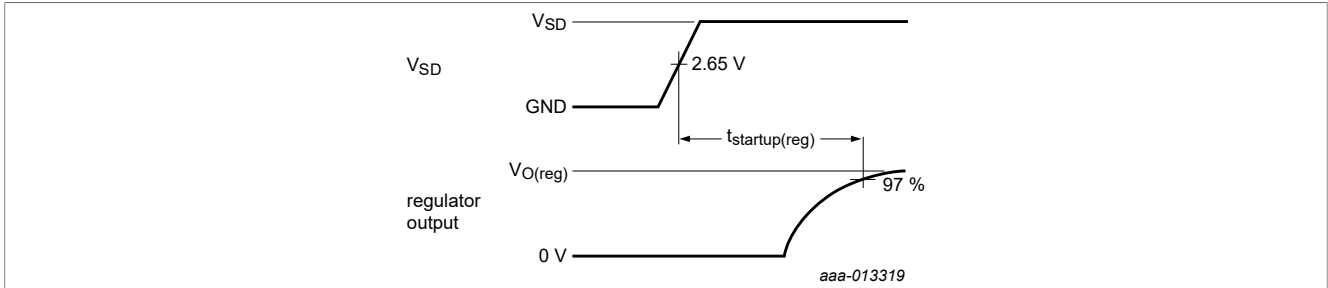

Measuring points:  $V_{SD}$  signal at 2.65 V and regulator output signal at 0.97  $V_{O(LDO)}$ .

Figure 6. Regulator start-up time

## 12.2 Level translator

Table 12. Level translator dynamic characteristics

At recommended operating conditions;  $V_{CCA} = 1.2\text{ V}$ ;  $T_{amb} = 25\text{ }^\circ\text{C}$ ; unless otherwise specified.

Symbol	Parameter	Conditions	Min	Typ	Max	Unit
<b>Host side transition times</b>						
$t_r$	rise time	SEL = HIGH (1.8 V card interface); $V_{CCA} = 1.8\text{ V}$	[1] -	0.4	1.0	ns
$t_f$	fall time		[1] -	0.4	1.0	ns
$t_r$	rise time	SEL = HIGH (1.8 V card interface); $V_{CCA} = 1.2\text{ V}$	[1] -	0.4	1.0	ns
$t_f$	fall time		[1] -	0.4	1.0	ns
<b>Card side transition times</b>						
$t_r$	rise time	SEL = HIGH (1.8 V card interface); $-40\text{ }^\circ\text{C} \leq T_{amb} \leq +85\text{ }^\circ\text{C}$	[2] 0.4	0.88	1.32	ns
$t_f$	fall time		[2] 0.4	0.88	1.32	ns
<b>Card input transition times</b>						
$t_r$	rise time	SEL = HIGH (1.8 V card interface); $-40\text{ }^\circ\text{C} \leq T_{amb} \leq +85\text{ }^\circ\text{C}$	[3] 0.2	0.5	0.96	ns
$t_f$	fall time		[3] 0.2	0.45	0.96	ns
<b>Host to card propoagation delay</b>						
DATxA to DATxB, CMDA to CMDB, CLKA to CLKB						
$t_{pd}$	propagation delay	SEL = HIGH (1.8 V card interface); $V_{CCA} = 1.2\text{ V}$	-	3.0	5.5	ns
CLKA to CLK_FB						
$t_{pd}$	propagation delay	SEL = HIGH (1.8 V card interface); $V_{CCA} = 1.2\text{ V}$	-	5.5	10.0	ns
<b>Card to host propagation delay</b>						
DATxB to DATxA, CMDB to CMDA						
$t_{pd}$	propagation delay	SEL = HIGH (1.8 V card interface); $V_{CCA} = 1.2\text{ V}$	-	2.5	4.5	ns

[1] transition between  $V_{OL} = 0.35 * V_{CCA}$  and  $V_{OH} = 0.65 * V_{CCA}$

[2] transition between  $V_{OL} = 0.45\text{ V}$  and  $V_{OH} = 1.4\text{ V}$

[3] Guaranteed by design; transition between  $V_{IL} = 0.58\text{ V}$  and  $V_{IH} = 1.27\text{ V}$  with  $C_{trace} = 3.5\text{ pF}$  and  $C_{card+CRADLE} = 12\text{ pF}$ , trace length = 11 mm

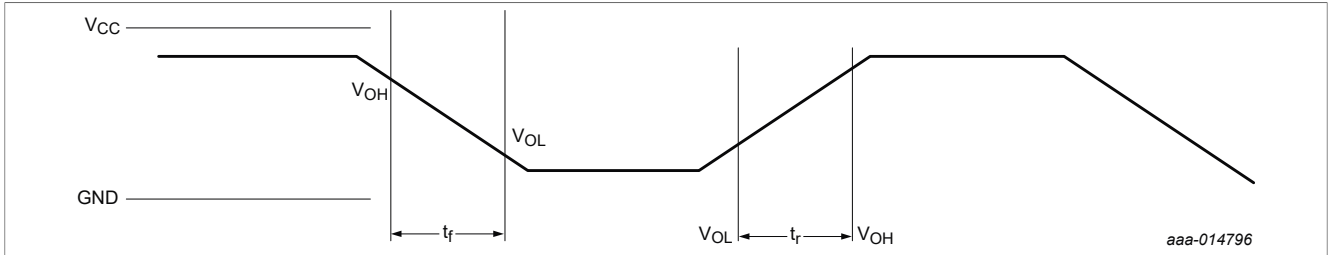

V<sub>OH</sub> and V<sub>OL</sub> are specified in Table 12 as [1] and [2]

Figure 7. Output rise and fall times

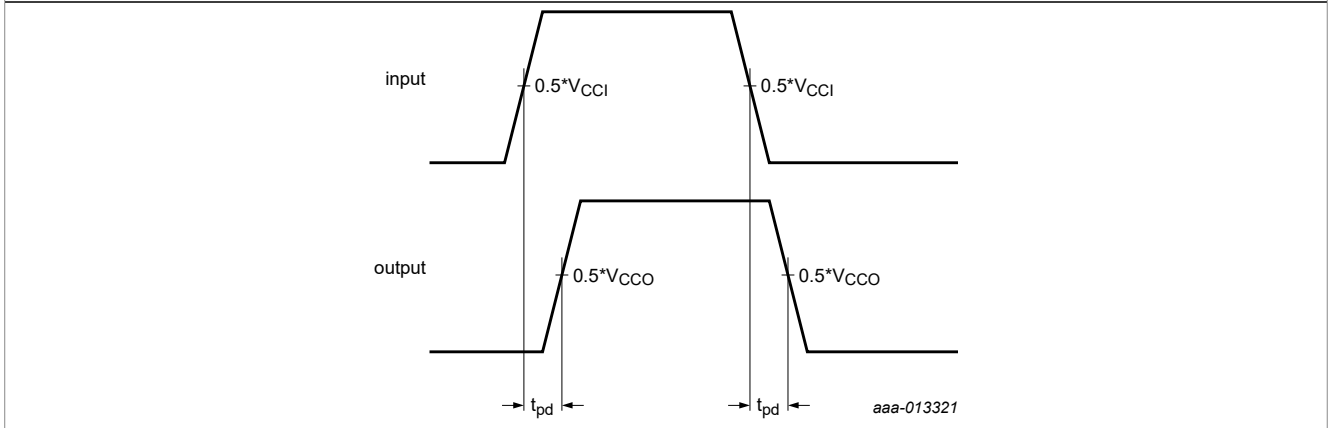

Output delay is for every single channel, from input to output, 0.5\*V<sub>CCI</sub> to 0.5\*V<sub>CCO</sub>, in which V<sub>CCI</sub> and V<sub>CCO</sub> are the input and output voltage domain.

Figure 8. Output delay timing

### 12.3 ESD characteristic of pin card detect

Table 13. ESD characteristic of card detect

At recommended operating conditions; T<sub>amb</sub> = +25 °C; voltages are referenced to GND (ground = 0 V); unless otherwise specified

Symbol	Parameter	Conditions	Min	Typ	Max	Unit
<b>ESD protection pins: CD</b>						
V <sub>BR</sub>	breakdown voltage	TLP; I = 1 mA	-	8	-	V
r <sub>dyn</sub>	dynamic resistance	positive transient	[1] -	0.5	-	Ω
		negative transient	[1] -	0.5	-	Ω

[1] TLP according to ANSI-ESD STM5.5.1/IEC 62615 Z<sub>0</sub> = 50 Ω; pulse width = 100 ns; rise time = 200 ps; averaging window = 50 ns to 80 ns

### 13 Test information

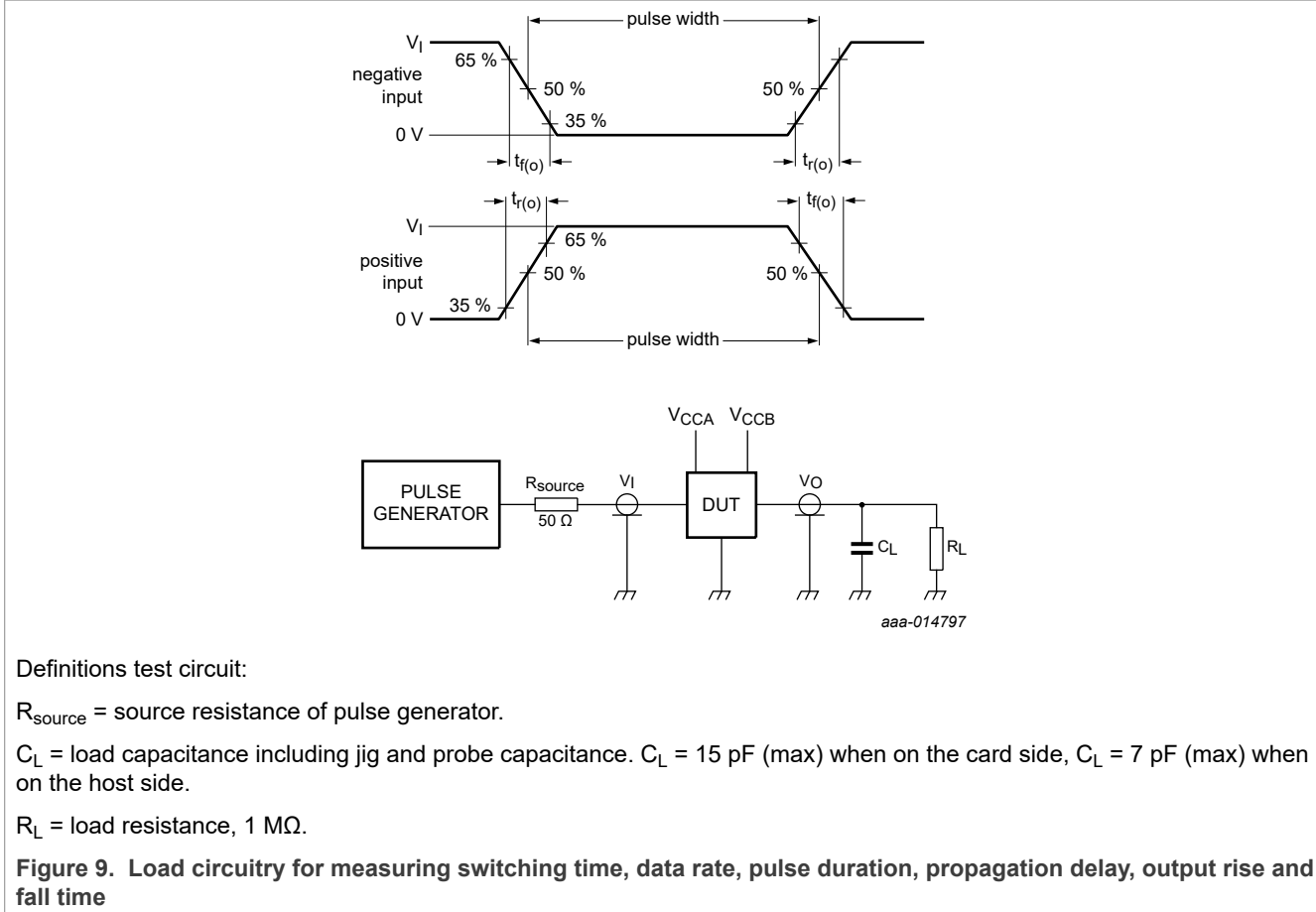

Definitions test circuit:

$R_{source}$  = source resistance of pulse generator.

$C_L$  = load capacitance including jig and probe capacitance.  $C_L = 15 \text{ pF}$  (max) when on the card side,  $C_L = 7 \text{ pF}$  (max) when on the host side.

$R_L$  = load resistance,  $1 \text{ M}\Omega$ .

**Figure 9. Load circuitry for measuring switching time, data rate, pulse duration, propagation delay, output rise and fall time**

14 Package outline

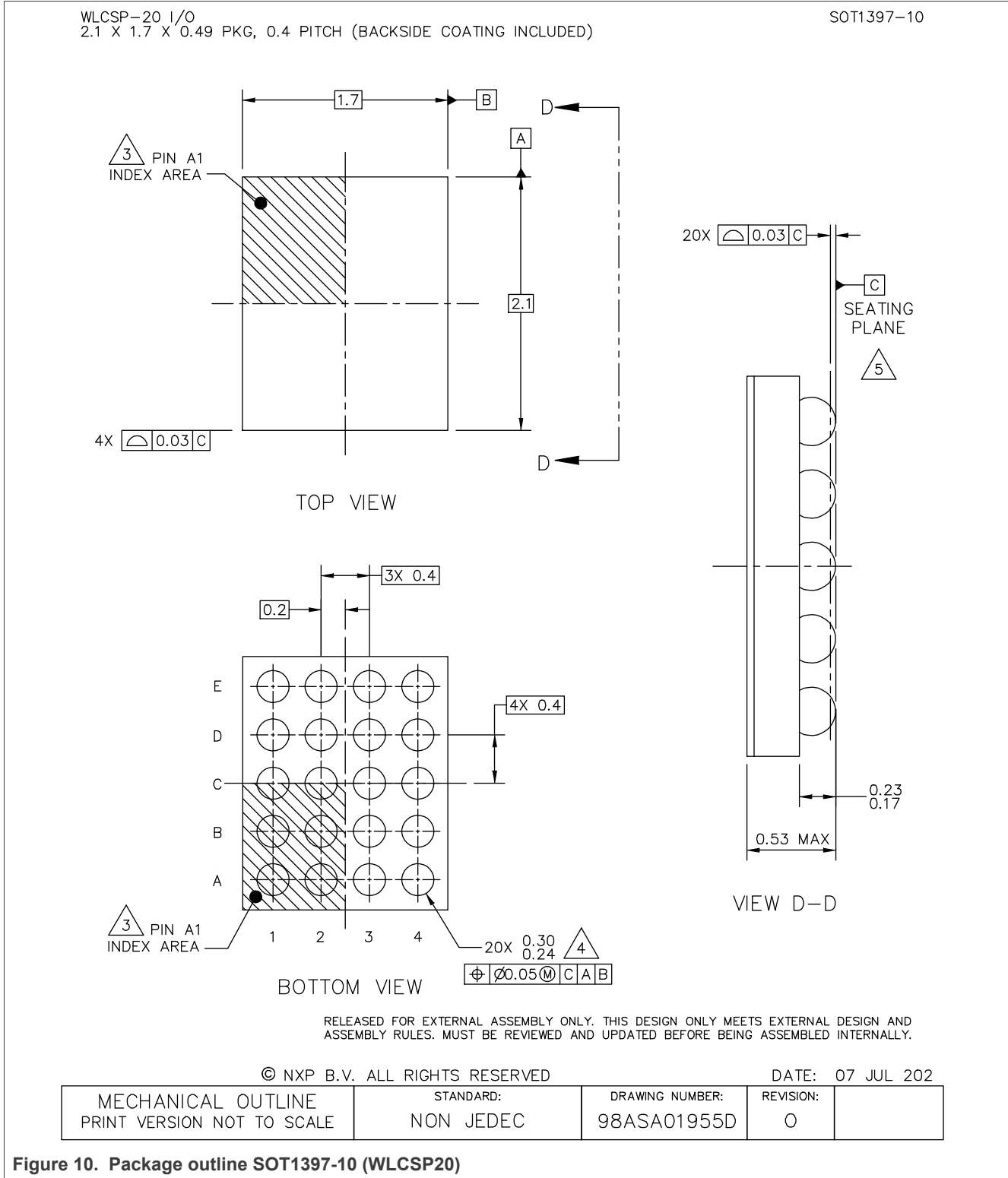

Figure 10. Package outline SOT1397-10 (WLCSP20)

## 15 Packing information

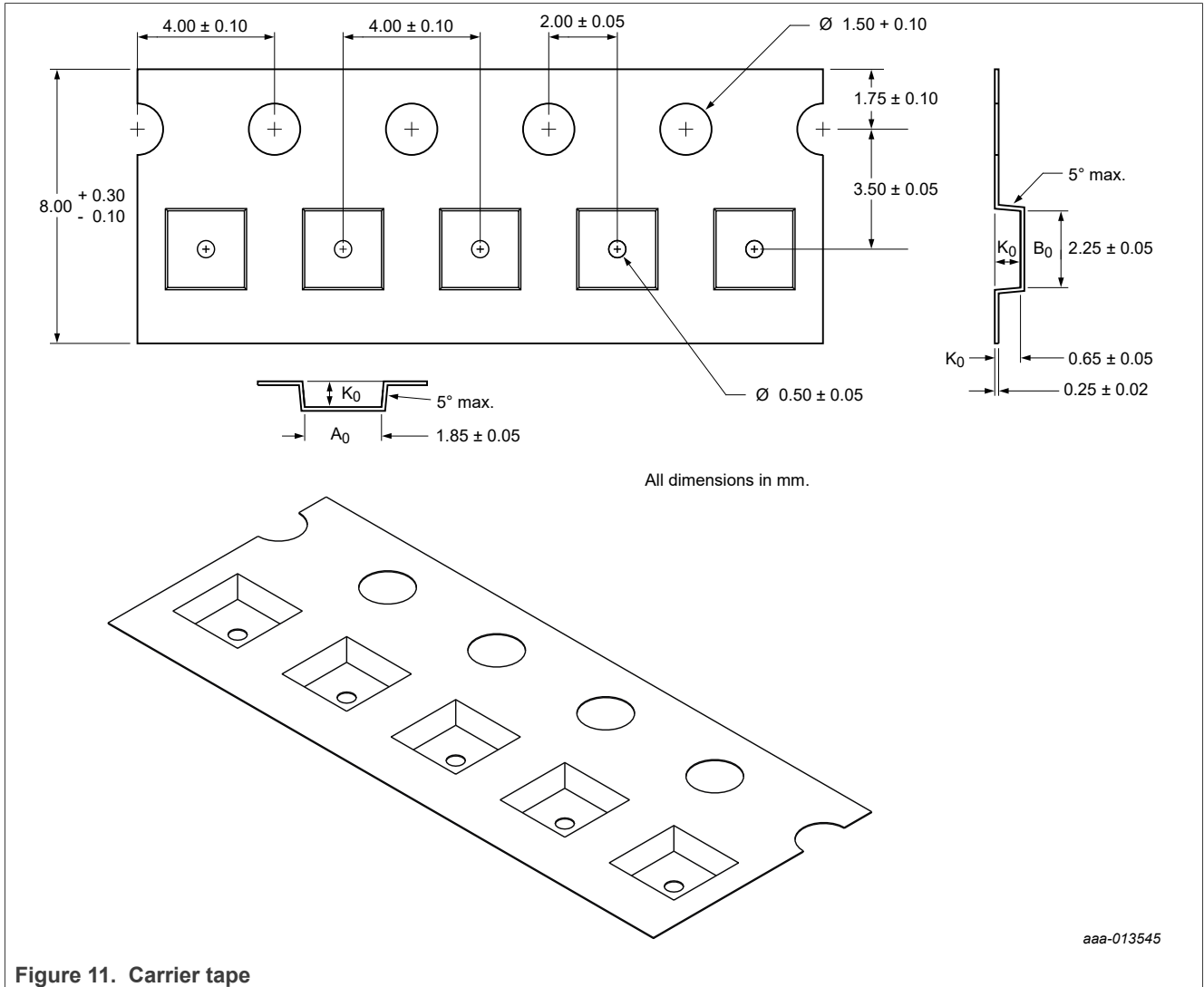

Figure 11. Carrier tape

## 16 Soldering of WLCSP packages

### 16.1 Introduction to soldering WLCSP packages

This text provides a very brief insight into a complex technology. A more in-depth account of soldering WLCSP (Wafer Level Chip-Size Packages) can be found in application note AN10439 “Wafer Level Chip Scale Package” and in application note AN10365 “Surface mount reflow soldering description”.

Wave soldering is not suitable for this package.

All NXP WLCSP packages are lead-free.

### 16.2 Board mounting

Board mounting of a WLCSP requires several steps:

1. Solder paste printing on the PCB
2. Component placement with a pick and place machine
3. The reflow soldering itself

**16.3 Reflow soldering**

Key characteristics in reflow soldering are:

- Lead-free versus SnPb soldering; note that a lead-free reflow process usually leads to higher minimum peak temperatures (see [Figure 12](#)) than a SnPb process, thus reducing the process window
- Solder paste printing issues, such as smearing, release, and adjusting the process window for a mix of large and small components on one board
- Reflow temperature profile; this profile includes preheat, reflow (in which the board is heated to the peak temperature), and cooling down. It is imperative that the peak temperature is high enough for the solder to make reliable solder joints (a solder paste characteristic) while being low enough that the packages and/or boards are not damaged. The peak temperature of the package depends on package thickness and volume and is classified in accordance with [Table 14](#).

**Table 14. Lead-free process (from J-STD-020D)**

Package thickness (mm)	Package reflow temperature (°C)		
	Volume (mm <sup>3</sup> )		
	< 350	350 to 2 000	> 2 000
< 1.6	260	260	260
1.6 to 2.5	260	250	245
> 2.5	250	245	245

Moisture sensitivity precautions, as indicated on the packing, must be respected at all times.

Studies have shown that small packages reach higher temperatures during reflow soldering, see [Figure 12](#).

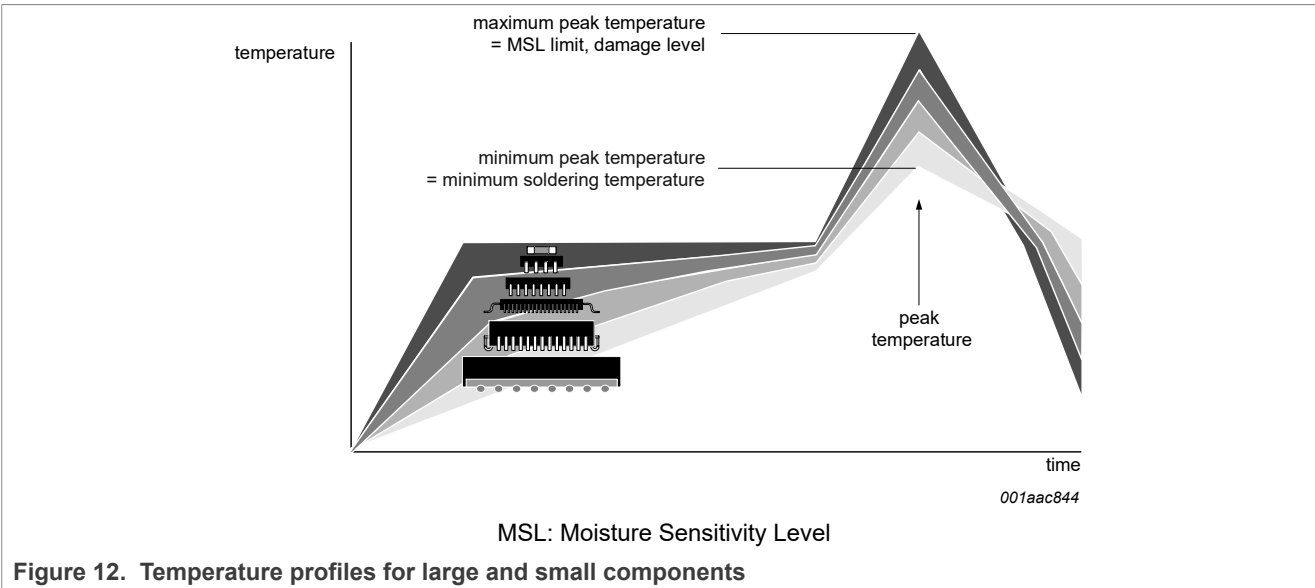

**Figure 12. Temperature profiles for large and small components**

For further information on temperature profiles, refer to Application Note AN10365 “Surface mount reflow soldering description”.

## 16.4 Stand off

The stand off between the substrate and the chip is determined by:

- The amount of printed solder on the substrate
- The size of the solder land on the substrate
- The bump height on the chip

The higher the stand off, the better the stresses are released due to TEC (Thermal Expansion Coefficient) differences between substrate and chip.

## 16.5 Quality of solder joint

A flip-chip joint is considered to be a good joint when the entire solder land has been wetted by the solder from the bump. The surface of the joint should be smooth and the shape symmetrical. The soldered joints on a chip should be uniform. Voids in the bumps after reflow can occur during the reflow process in bumps with high ratio of bump diameter to bump height, i.e. low bumps with large diameter. No failures have been found to be related to these voids. Solder joint inspection after reflow can be done with X-ray to monitor defects such as bridging, open circuits and voids.

## 16.6 Rework

In general, rework is not recommended. By rework we mean the process of removing the chip from the substrate and replacing it with a new chip. If a chip is removed from the substrate, most solder balls of the chip will be damaged. In that case it is recommended not to re-use the chip again. Device removal can be done when the substrate is heated until it is certain that all solder joints are molten. The chip can then be carefully removed from the substrate without damaging the tracks and solder lands on the substrate. Removing the device must be done using plastic tweezers, because metal tweezers can damage the silicon. The surface of the substrate should be carefully cleaned and all solder and flux residues and/or underfill removed. When a new chip is placed on the substrate, use the flux process instead of solder on the solder lands. Apply flux on the bumps at the chip side as well as on the solder pads on the substrate. Place and align the new chip while viewing with a microscope. To reflow the solder, use the solder profile shown in application note AN10365 "Surface mount reflow soldering description".

## 16.7 Cleaning

Cleaning can be done after reflow soldering.

## 17 Abbreviations

Table 15. Abbreviations

Acronym	Description
DUT	Device Under Test
EMI	ElectroMagnetic Interference
ESD	ElectroStatic Discharge
MMC	MultiMedia Card
PCB	Printed-Circuit Board
RoHS	Restriction of Hazardous Substances
SD	Secure Digital
WLCSP	Wafer-Level Chip-Scale Package

## 18 Revision history

Table 16. Revision history

Document ID	Release date	Data sheet status	Change notice	Supersedes
NVT4857UK v.3.0	20230719	Product data sheet	-	NVT4857UK v.2
Modifications:	<ul style="list-style-type: none"> <li>• Updated <a href="#">Figure 2</a></li> <li>• <a href="#">Table 10</a>: Changed "C<sub>ch</sub>" to "C<sub>io</sub>", removed conditions and table note [2], updated typ and max values</li> <li>• <a href="#">Figure 9</a>: Deleted R<sub>term</sub> and ground from the circuit; updated definitions</li> </ul>			
NVT4857UK v.2.1	20221107	Product data sheet	-	NVT4857UK v.2
NVT4857UK v.2	20180606	Product data sheet	201805042I	NVT4857UK v.1.1
NVT4857UK v.1.1	20161213	Product data sheet	201612019I	NVT4857UK v.1
NVT4857UK v.1	20151120	Product data sheet	-	-

## 19 Legal information

### 19.1 Data sheet status

Document status <sup>[1][2]</sup>	Product status <sup>[3]</sup>	Definition
Objective [short] data sheet	Development	This document contains data from the objective specification for product development.
Preliminary [short] data sheet	Qualification	This document contains data from the preliminary specification.
Product [short] data sheet	Production	This document contains the product specification.

[1] Please consult the most recently issued document before initiating or completing a design.

[2] The term 'short data sheet' is explained in section "Definitions".

[3] The product status of device(s) described in this document may have changed since this document was published and may differ in case of multiple devices. The latest product status information is available on the Internet at URL <http://www.nxp.com>.

### 19.2 Definitions

**Draft** — A draft status on a document indicates that the content is still under internal review and subject to formal approval, which may result in modifications or additions. NXP Semiconductors does not give any representations or warranties as to the accuracy or completeness of information included in a draft version of a document and shall have no liability for the consequences of use of such information.

**Short data sheet** — A short data sheet is an extract from a full data sheet with the same product type number(s) and title. A short data sheet is intended for quick reference only and should not be relied upon to contain detailed and full information. For detailed and full information see the relevant full data sheet, which is available on request via the local NXP Semiconductors sales office. In case of any inconsistency or conflict with the short data sheet, the full data sheet shall prevail.

**Product specification** — The information and data provided in a Product data sheet shall define the specification of the product as agreed between NXP Semiconductors and its customer, unless NXP Semiconductors and customer have explicitly agreed otherwise in writing. In no event however, shall an agreement be valid in which the NXP Semiconductors product is deemed to offer functions and qualities beyond those described in the Product data sheet.

### 19.3 Disclaimers

**Limited warranty and liability** — Information in this document is believed to be accurate and reliable. However, NXP Semiconductors does not give any representations or warranties, expressed or implied, as to the accuracy or completeness of such information and shall have no liability for the consequences of use of such information. NXP Semiconductors takes no responsibility for the content in this document if provided by an information source outside of NXP Semiconductors.

In no event shall NXP Semiconductors be liable for any indirect, incidental, punitive, special or consequential damages (including - without limitation - lost profits, lost savings, business interruption, costs related to the removal or replacement of any products or rework charges) whether or not such damages are based on tort (including negligence), warranty, breach of contract or any other legal theory.

Notwithstanding any damages that customer might incur for any reason whatsoever, NXP Semiconductors' aggregate and cumulative liability towards customer for the products described herein shall be limited in accordance with the Terms and conditions of commercial sale of NXP Semiconductors.

**Right to make changes** — NXP Semiconductors reserves the right to make changes to information published in this document, including without limitation specifications and product descriptions, at any time and without notice. This document supersedes and replaces all information supplied prior to the publication hereof.

**Suitability for use** — NXP Semiconductors products are not designed, authorized or warranted to be suitable for use in life support, life-critical or safety-critical systems or equipment, nor in applications where failure or malfunction of an NXP Semiconductors product can reasonably be expected to result in personal injury, death or severe property or environmental damage. NXP Semiconductors and its suppliers accept no liability for inclusion and/or use of NXP Semiconductors products in such equipment or applications and therefore such inclusion and/or use is at the customer's own risk.

**Applications** — Applications that are described herein for any of these products are for illustrative purposes only. NXP Semiconductors makes no representation or warranty that such applications will be suitable for the specified use without further testing or modification.

Customers are responsible for the design and operation of their applications and products using NXP Semiconductors products, and NXP Semiconductors accepts no liability for any assistance with applications or customer product design. It is customer's sole responsibility to determine whether the NXP Semiconductors product is suitable and fit for the customer's applications and products planned, as well as for the planned application and use of customer's third party customer(s). Customers should provide appropriate design and operating safeguards to minimize the risks associated with their applications and products.

NXP Semiconductors does not accept any liability related to any default, damage, costs or problem which is based on any weakness or default in the customer's applications or products, or the application or use by customer's third party customer(s). Customer is responsible for doing all necessary testing for the customer's applications and products using NXP Semiconductors products in order to avoid a default of the applications and the products or of the application or use by customer's third party customer(s). NXP does not accept any liability in this respect.

**Limiting values** — Stress above one or more limiting values (as defined in the Absolute Maximum Ratings System of IEC 60134) will cause permanent damage to the device. Limiting values are stress ratings only and (proper) operation of the device at these or any other conditions above those given in the Recommended operating conditions section (if present) or the Characteristics sections of this document is not warranted. Constant or repeated exposure to limiting values will permanently and irreversibly affect the quality and reliability of the device.

**Terms and conditions of commercial sale** — NXP Semiconductors products are sold subject to the general terms and conditions of commercial sale, as published at <http://www.nxp.com/profile/terms>, unless otherwise agreed in a valid written individual agreement. In case an individual agreement is concluded only the terms and conditions of the respective agreement shall apply. NXP Semiconductors hereby expressly objects to applying the customer's general terms and conditions with regard to the purchase of NXP Semiconductors products by customer.

**No offer to sell or license** — Nothing in this document may be interpreted or construed as an offer to sell products that is open for acceptance or the grant, conveyance or implication of any license under any copyrights, patents or other industrial or intellectual property rights.

**Quick reference data** — The Quick reference data is an extract of the product data given in the Limiting values and Characteristics sections of this document, and as such is not complete, exhaustive or legally binding.

**Export control** — This document as well as the item(s) described herein may be subject to export control regulations. Export might require a prior authorization from competent authorities.

**Suitability for use in non-automotive qualified products** — Unless this document expressly states that this specific NXP Semiconductors product is automotive qualified, the product is not suitable for automotive use. It is neither qualified nor tested in accordance with automotive testing or application requirements. NXP Semiconductors accepts no liability for inclusion and/or use of non-automotive qualified products in automotive equipment or applications.

In the event that customer uses the product for design-in and use in automotive applications to automotive specifications and standards, customer (a) shall use the product without NXP Semiconductors' warranty of the product for such automotive applications, use and specifications, and (b) whenever customer uses the product for automotive applications beyond NXP Semiconductors' specifications such use shall be solely at customer's own risk, and (c) customer fully indemnifies NXP Semiconductors for any liability, damages or failed product claims resulting from customer design and use of the product for automotive applications beyond NXP Semiconductors' standard warranty and NXP Semiconductors' product specifications.

**Translations** — A non-English (translated) version of a document, including the legal information in that document, is for reference only. The English version shall prevail in case of any discrepancy between the translated and English versions.

**Security** — Customer understands that all NXP products may be subject to unidentified vulnerabilities or may support established security standards or specifications with known limitations. Customer is responsible for the design and operation of its applications and products throughout their lifecycles to reduce the effect of these vulnerabilities on customer's applications and products. Customer's responsibility also extends to other open and/or proprietary technologies supported by NXP products for use in customer's applications. NXP accepts no liability for any vulnerability. Customer should regularly check security updates from NXP and follow up appropriately.

Customer shall select products with security features that best meet rules, regulations, and standards of the intended application and make the ultimate design decisions regarding its products and is solely responsible for compliance with all legal, regulatory, and security related requirements concerning its products, regardless of any information or support that may be provided by NXP.

NXP has a Product Security Incident Response Team (PSIRT) (reachable at [PSIRT@nxp.com](mailto:PSIRT@nxp.com)) that manages the investigation, reporting, and solution release to security vulnerabilities of NXP products.

## 19.4 Trademarks

Notice: All referenced brands, product names, service names, and trademarks are the property of their respective owners.

**NXP** — wordmark and logo are trademarks of NXP B.V.

## Tables

Tab. 1.	Ordering information .....	2	Tab. 9.	Integrated resistors .....	9
Tab. 2.	Ordering options .....	2	Tab. 10.	Static characteristics .....	9
Tab. 3.	Pin allocation table .....	5	Tab. 11.	Voltage regulator .....	11
Tab. 4.	Pin description .....	6	Tab. 12.	Level translator dynamic characteristics .....	12
Tab. 5.	Supported modes .....	6	Tab. 13.	ESD characteristic of card detect .....	13
Tab. 6.	SD card side voltage level control signal truth table .....	7	Tab. 14.	Lead-free process (from J-STD-020D) .....	17
Tab. 7.	Limiting values .....	8	Tab. 15.	Abbreviations .....	18
Tab. 8.	Operating conditions .....	8	Tab. 16.	Revision history .....	19

## Figures

Fig. 1.	Application diagram .....	3	Fig. 9.	Load circuitry for measuring switching time, data rate, pulse duration, propagation delay, output rise and fall time .....	14
Fig. 2.	Functional diagram .....	4	Fig. 10.	Package outline SOT1397-10 (WLCSP20) .....	15
Fig. 3.	Pin configuration WLCSP20 .....	5	Fig. 11.	Carrier tape .....	16
Fig. 4.	NVT4857UK pinout transparent top view .....	5	Fig. 12.	Temperature profiles for large and small components .....	17
Fig. 5.	Regulator mode change timing .....	11			
Fig. 6.	Regulator start-up time .....	12			
Fig. 7.	Output rise and fall times .....	13			
Fig. 8.	Output delay timing .....	13			

## Contents

---

<b>1</b>	<b>General description</b> .....	<b>1</b>
<b>2</b>	<b>Features and benefits</b> .....	<b>1</b>
<b>3</b>	<b>Applications</b> .....	<b>1</b>
<b>4</b>	<b>Ordering information</b> .....	<b>2</b>
4.1	Ordering options .....	2
<b>5</b>	<b>Block diagram</b> .....	<b>3</b>
<b>6</b>	<b>Functional diagram</b> .....	<b>4</b>
<b>7</b>	<b>Pinning information</b> .....	<b>5</b>
7.1	Pinning .....	5
7.2	Pin description .....	6
<b>8</b>	<b>Functional description</b> .....	<b>6</b>
8.1	Level translator .....	6
8.2	Enable and direction control .....	7
8.3	Integrated voltage regulator .....	7
8.4	Feedback clock channel .....	7
8.5	EMI filter .....	7
8.6	ESD protection .....	8
<b>9</b>	<b>Limiting values</b> .....	<b>8</b>
<b>10</b>	<b>Recommended operating conditions</b> .....	<b>8</b>
<b>11</b>	<b>Static characteristics</b> .....	<b>9</b>
<b>12</b>	<b>Dynamic characteristics</b> .....	<b>11</b>
12.1	Voltage regulator .....	11
12.2	Level translator .....	12
12.3	ESD characteristic of pin card detect .....	13
<b>13</b>	<b>Test information</b> .....	<b>14</b>
<b>14</b>	<b>Package outline</b> .....	<b>15</b>
<b>15</b>	<b>Packing information</b> .....	<b>16</b>
<b>16</b>	<b>Soldering of WLCSP packages</b> .....	<b>16</b>
16.1	Introduction to soldering WLCSP packages .....	16
16.2	Board mounting .....	16
16.3	Reflow soldering .....	17
16.4	Stand off .....	18
16.5	Quality of solder joint .....	18
16.6	Rework .....	18
16.7	Cleaning .....	18
<b>17</b>	<b>Abbreviations</b> .....	<b>18</b>
<b>18</b>	<b>Revision history</b> .....	<b>19</b>
<b>19</b>	<b>Legal information</b> .....	<b>20</b>



---

Please be aware that important notices concerning this document and the product(s) described herein, have been included in section 'Legal information'.

---

## Looking for pricing, stock, or lifecycle information?

Click below to explore more details on WIN SOURCE:

-  [View NVT4857UKAZ on WIN SOURCE](#)
-  [NXP / Nexperia Information](#)

## Optimize Your Supply Chain with WIN SOURCE Solutions

-  Global Sourcing Solution
-  Obsolete Management
-  Cost Control Management
-  Shortage Management
-  Alternative Solution
-  Excess Inventory Management