



**THE DATASHEET OF  
9774015151R**



# SMD Steel Spacer

**WA-SMSI, WA-SMST & WA-SMSE**

**Performance  
Testing**



## **Content**

1. Shear Force
2. Pull Strength
3. Breaking Torque
4. Additional Information
5. Test Conditions

# Shear Force

Distance pressure point 1mm



Performance Testing with lead-free solder paste				
Test Sample	Shearforce (in N)			
	9771xxx360	9774xxx360 9774xxx960	9774xxx151 9774xxx951	9774xxx243
1	665	529	353	174
2	563	540	411	184
3	564	699	449	245
4	652	706	405	203
5	632	645	393	188
6	762	630	386	250
7	799	613	431	211
8	654	520	445	173
9	686	565	413	212
10	669	711	440	214
11	715	697	481	203
12	678	596	425	190
13	812	726	392	225
14	700	451	428	229
15	602	763	408	196
16	702	625	444	228
17	570	525	449	190
18	772	713	450	223
19	634	569	419	228
20	729	760	411	198
21	614	606	477	237
22	668	721	355	203
23	604	471	370	247
24	631	573	461	223
25	727	682	473	241
26	647	506	407	248
27	732	716	372	253
28	804	604	444	252
29	657	501	387	184
30	676	681	434	211
<b>Min.</b>	<b>563</b>	<b>451</b>	<b>353</b>	<b>173</b>
<b>Max.</b>	<b>812</b>	<b>763</b>	<b>481</b>	<b>253</b>
<b>Average</b>	<b>677</b>	<b>621</b>	<b>420</b>	<b>215</b>

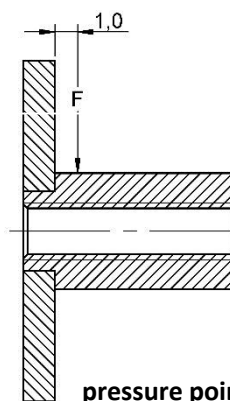
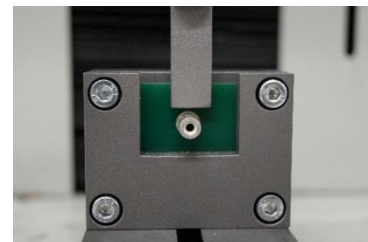
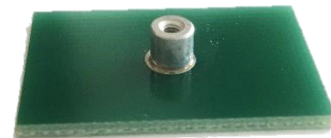

pressure point Shearforce (distance 1mm)

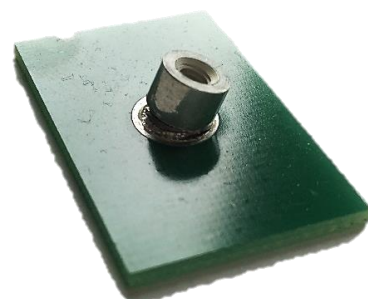

Test PCB for the Checking fixture Shearforce

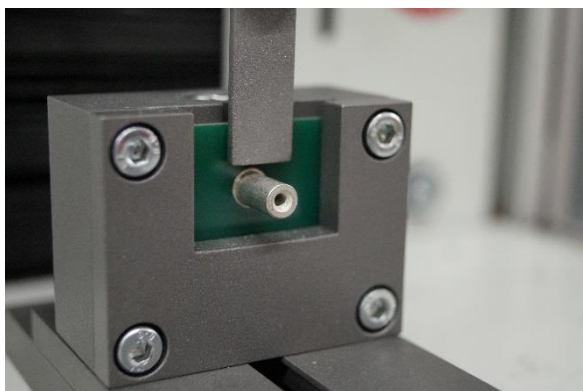

Checking fixture Shearforce

The Data is only for reference. The performance always depends on the application. The parts are tested under laboratory conditions and after the specification of Würth Elektronik eiSos. We would be pleased to provide you samples for testing.

# Shear Force

Distance pressure point 6mm



Performance Testing with lead-free solder paste				
Test Sample	Shearforce (in N)			
	9771xxx360	9774xxx360 9774xxx960	9774xxx151 9774xxx951	9774xxx243
1	372	205	164	139
2	360	179	175	132
3	285	197	144	117
4	362	196	152	122
5	340	200	159	153
6	365	225	139	150
7	345	167	145	143
8	384	188	145	126
9	330	202	160	120
10	282	176	153	114
11	340	189	151	131
12	320	212	148	146
13	330	191	146	121
14	290	186	150	155
15	295	221	135	152
16	340	202	150	124
17	300	219	160	124
18	350	200	163	138
19	300	200	141	130
20	320	220	144	138
21	334	174	140	137
22	330	226	145	123
23	385	221	140	146
24	290	203	184	124
25	314	224	182	153
26	280	192	142	153
27	320	203	172	119
28	350	181	139	136
29	290	162	136	153
30	330	178	203	133
<b>Min.</b>	<b>280</b>	<b>162</b>	<b>135</b>	<b>114</b>
<b>Max.</b>	<b>385</b>	<b>226</b>	<b>203</b>	<b>155</b>
<b>Average</b>	<b>328</b>	<b>198</b>	<b>154</b>	<b>135</b>

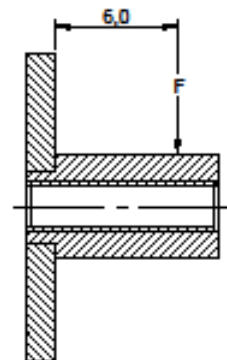
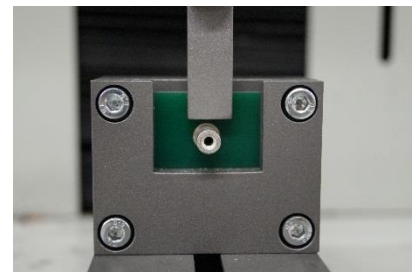
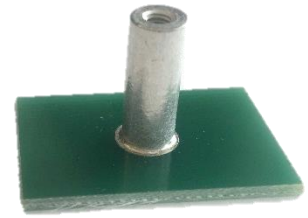

pressure point Shearforce (distance 6mm)

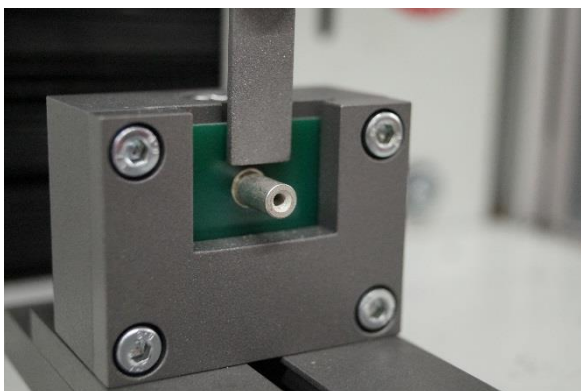

Checking fixture Shearforce

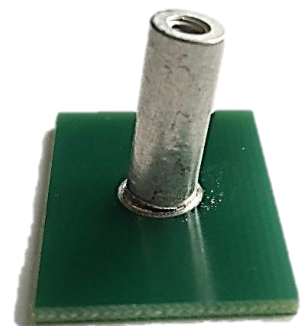

Test PCB for the Checking fixture Shearforce

The Data is only for reference. The performance always depends on the application. The parts are tested under laboratory conditions and after the specification of Würth Elektronik eiSos. We would be pleased to provide you samples for testing.

# Pull Strength



Performance Testing with lead-free solder paste				
Test Sample	Pull Strength (in N)			
	9771xxx360	9774xxx360 9774xxx960	9774xxx151 9774xxx951	9774xxx243
1	500	530	339	470
2	450	350	357	380
3	580	540	316	363
4	600	450	303	353
5	620	480	286	360
6	630	340	427	244
7	570	500	244	274
8	690	400	348	405
9	710	340	352	256
10	800	350	329	330
11	550	350	449	337
12	620	320	427	246
13	610	440	381	289
14	650	350	335	414
15	630	450	324	404
16	500	500	243	258
17	620	380	328	254
18	610	340	279	405
19	520	350	491	246
20	630	350	368	313
21	570	450	336	402
22	640	340	278	459
23	600	500	346	201
24	700	380	331	182
25	780	430	276	179
26	780	360	195	274
27	640	470	323	441
28	740	420	373	452
29	620	440	313	222
30	650	380	205	248
<b>Min.</b>	<b>450</b>	<b>320</b>	<b>195</b>	<b>179</b>
<b>Max.</b>	<b>800</b>	<b>540</b>	<b>491</b>	<b>470</b>
<b>Average</b>	<b>627</b>	<b>409</b>	<b>330</b>	<b>322</b>

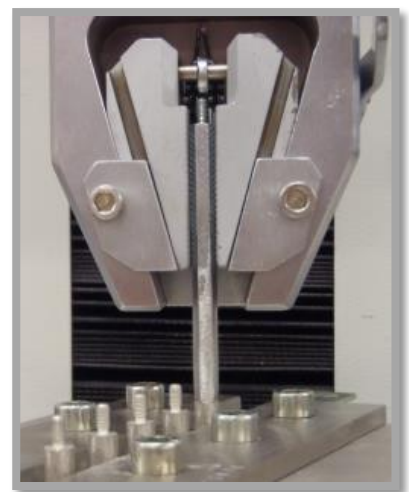

Checking fixture Pull Strength

The Data is only for reference. The performance always depends on the application. The parts are tested under laboratory conditions and after the specification of Würth Elektronik eiSos. We would be pleased to provide you samples for testing.

# Breaking Torque

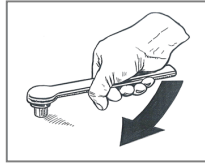

Performance Testing with lead-free Solder paste

Test Sample	Breaking Torque							
	9771xxx360		9774xxx360 / 9774xxx960		9774xxx151 / 9774xxx951		9774xxx243	
	Nm	Point of breaking	Nm	Point of breaking	Nm	Point of breaking	Nm	Point of breaking
1	1,2	Thread	1,8	Solder	1,0	Solder Joint	0,7	Solder Joint
2	1,1	Thread	1,9	Solder	1,1	Solder Joint	0,8	Screw
3	1,3	Thread	1,8	Solder	0,9	Solder Joint	0,7	Solder Joint
4	1,3	Thread	1,9	Solder	1,1	Solder Joint	0,7	Solder Joint
5	1,3	Thread	2,1	Solder	1,2	Solder Joint	0,7	Solder Joint
6	1,1	Thread	1,9	Solder	1,0	Solder Joint	0,7	Screw
7	1,2	Thread	1,6	Solder	1,1	Solder Joint	0,6	Solder Joint
8	1,3	Thread	1,9	Solder	1,2	Solder Joint	0,7	Screw
9	1,3	Thread	2,1	Solder	1,1	Solder Joint	0,7	Solder Joint
10	1,1	Thread	1,7	Solder	1,1	Solder Joint	0,7	Solder Joint
11	1,2	Thread	2,0	Solder	1,1	Solder Joint	0,7	Solder Joint
12	1,4	Thread	1,8	Solder	1,0	Solder Joint	0,7	Solder Joint
13	1,4	Thread	1,7	Solder	1,1	Solder Joint	0,8	Solder Joint
14	1,3	Thread	1,8	Solder	1,0	Solder Joint	0,7	Solder Joint
15	1,4	Thread	1,8	Solder	1,0	Solder Joint	0,8	Solder Joint
16	1,2	Thread	1,6	Solder	1,2	Solder Joint	0,7	Screw
17	1,1	Thread	2,1	Solder	0,9	Solder Joint	0,7	Solder Joint
18	1,2	Thread	1,7	Solder	1,0	Solder Joint	0,7	Screw
19	1,1	Solder	1,7	Solder	1,0	Solder Joint	0,7	Solder Joint
20	1,3	Thread	1,9	Solder	1,0	Solder Joint	0,7	Solder Joint
21	1,2	Thread	1,7	Solder	1,2	Solder Joint	0,7	Solder Joint
22	1,2	Thread	1,6	Solder	1,2	Solder Joint	0,7	Solder Joint
23	1,4	Thread	1,6	Solder	1,8	Solder Joint	0,7	Solder Joint
24	1,4	Thread	1,7	Solder	1,1	Solder Joint	0,8	Solder Joint
25	1,4	Thread	1,8	Solder	1,1	Solder Joint	0,7	Solder Joint
26	1,4	Thread	1,6	Solder	1,0	Solder Joint	0,7	Solder Joint
27	1,1	Thread	1,9	Solder	1,2	Solder Joint	0,7	Screw
28	1,2	Thread	1,6	Solder	1,0	Solder Joint	0,7	Screw
29	1,4	Thread	1,7	Solder	1,1	Solder Joint	0,7	Screw
30	1,2	Thread	1,9	Solder	1,1	Solder Joint	0,7	Solder Joint
<b>Min.</b>	<b>1,1</b>		<b>1,6</b>		<b>0,9</b>		<b>0,6</b>	
<b>Max.</b>	<b>1,4</b>		<b>2,1</b>		<b>1,8</b>		<b>0,8</b>	
<b>Average</b>	<b>1,3</b>		<b>1,8</b>		<b>1,1</b>		<b>0,7</b>	

Digital torque wrench for Breaking Torque

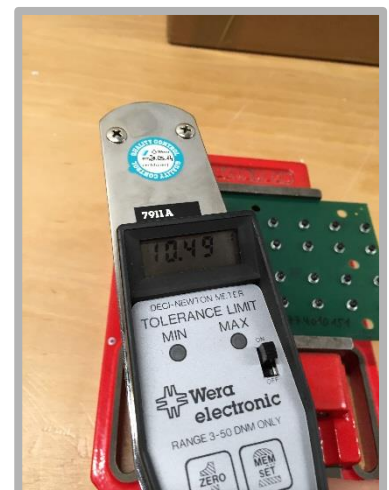

Test assembly according to **DIN 267/ Part 25**. Using metric screws with property class 12.9 and hexagonal recess according to DIN 912.

The Data is only for reference. The performance always depends on the application. The parts are tested under laboratory conditions and after the specification of Würth Elektronik eiSos. We would be pleased to provide you samples for testing.

# Additional Test

second reflow process with upside down circuit board

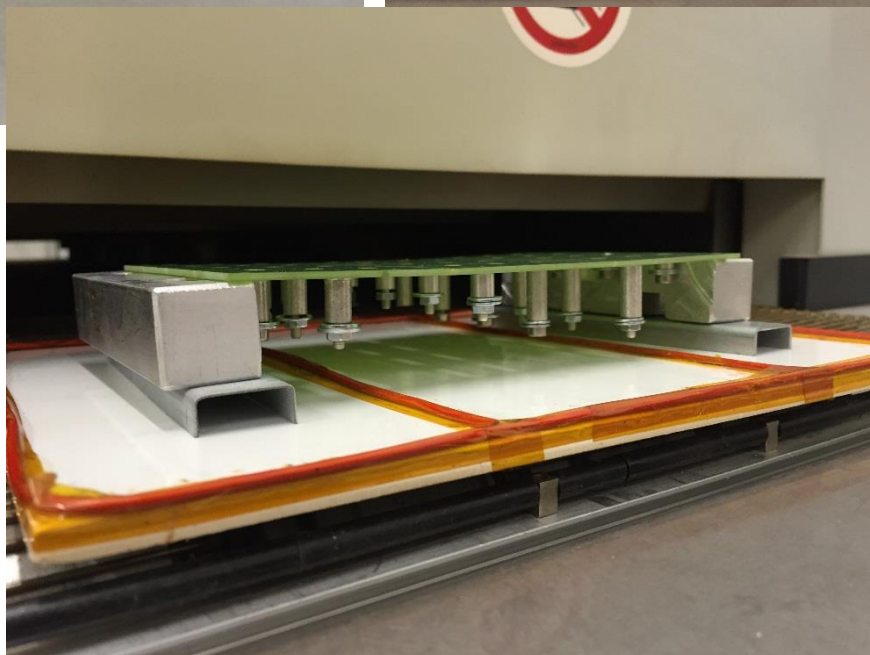
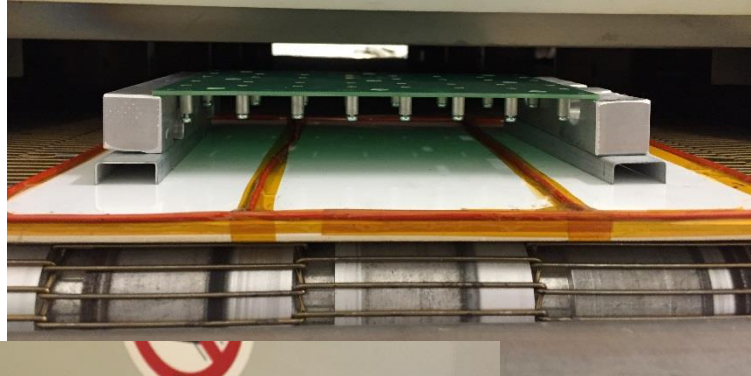

The Data is only for reference. The performance always depends on the application. The parts are tested under laboratory conditions and after the specification of Würth Elektronik eiSos. We would be pleased to provide you samples for testing.

# Land Pattern & Stencil Suggestion



## WA-SMSE

### M3

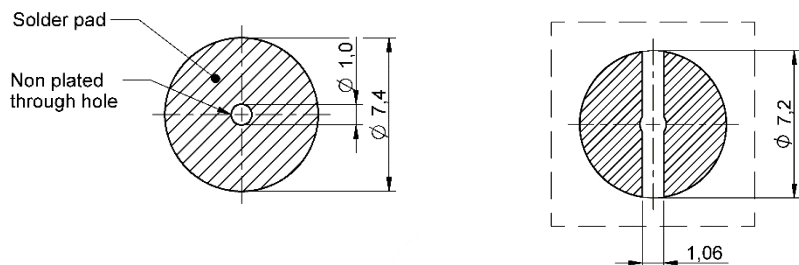

## WA-SMSI / WA-SMST

### M3

Through Hole 3.3mm

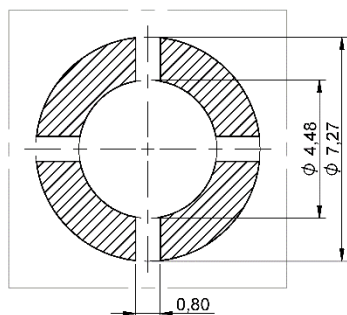
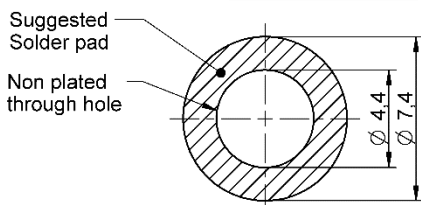

### M2.5

Through Hole 2.7mm

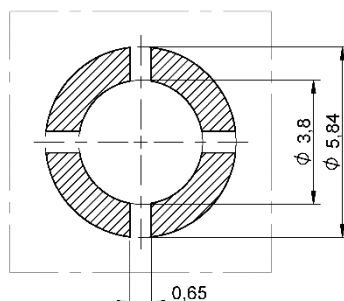
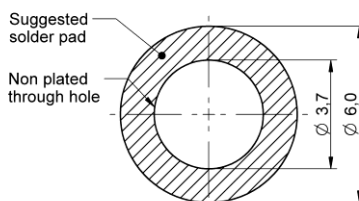

### M2

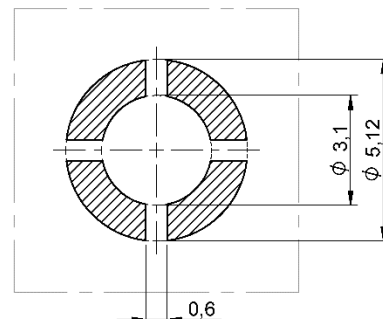
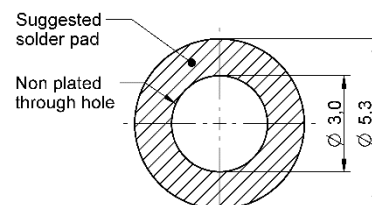

- The Drill Hole in the circuit board for the alignment pin and the screw must not be through-contacted.

# Our Requirements for SMD Steel Spacer



## ✓ Five Time Reflow Test

- *J-STD-020D*

## ✓ Solderability

- *JESD22-B102*

## ✓ Thermal Shock

- **MIL-STD-202, Method 107**
  - *Temperature -55°C to 155°C*
  - *Dwell time 30 minutes*
  - *Cycles: 500*
  - *Transfer time max. 20s*

## ✓ Vibration Test

- **MIL-STD-202, Method 204**
  - *10g's for 20minutes*
  - *12 cycles each of 3 orientations*
  - *15-2000Hz*

## ✓ Moisture Resistance

- **MIL-STD-202, Method 106**
  - *Temperature: 65°C*
  - *Humidity: 95%*
  - *Duration: 500h*

## ✓ RoHS & REACH Compliant

### Conditions:

- |                        |  |
|------------------------|--|
| ▪ Oven:                | Solano RO 500  |
| ▪ Soldering profile:   | IPC/JEDEC J-STD-020D   |
| ▪ Highest Temperature: | 305 °C   |
| ▪ PCB                  | 1,55mm thick, double Layer FP-4  |
| ▪ PCB Surface:         | 35µ Cu, NiAu-finish  |
| ▪ Solder Paste:        | Keatin: Alloy Sn96,5AG3CU0,5/Metall 88%  |
| ▪ Stencil thickness:   | 150 µm   |
| ▪ Vias:                | None   |
| ▪ Spokes:              | 9771xxx360 – 2-spoke stencil<br>9774xxx360/9774xxx151/9774xxx234 – 4-spoke stencil |

## Looking for pricing, stock, or lifecycle information?

Click below to explore more details on WIN SOURCE:

 [View 9774015151R on WIN SOURCE](#)

 [Wurth Electronics Inc Information](#)

## Optimize Your Supply Chain with WIN SOURCE Solutions

-  Global Sourcing Solution
-  Obsolete Management
-  Cost Control Management
-  Shortage Management
-  Alternative Solution
-  Excess Inventory Management