



**THE DATASHEET OF**  
**34.51.7.005.0010**



# Ultra-slim PCB Relays (EMR or SSR) 0.1 - 0.2 - 2 - 6 A



Bottling plant



Packaging machines



Labelling machines



Road / tunnel lighting



Burners, boilers and furnaces



Timers and lighting controls

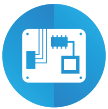

Electronic circuit boards



Programmable controllers

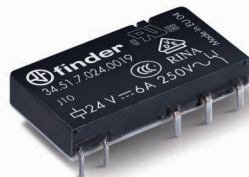
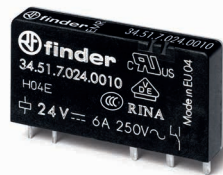



**Ultra-slim 1 Pole - 6 A relay**

**Printed circuit mount**

- direct or via PCB socket (according to type)

**35 mm rail mount**

- via screw, screwless or push-in terminal sockets

- 1 Pole changeover contacts or 1 Pole normally open contact
- Ultra slim (5 mm), package
- Sensitive DC coil - 170 mW (Dual AC/DC coil drive possible using 93 series sockets)
- UL Listing (certain relay/socket combinations)
- Cadmium Free contact materials
- 8/8 mm clearance/creepage distance
- 6 kV (1.2/50 μs) insulation, coil-contacts

FOR UL RATINGS SEE:

"General technical information" page V

For outline drawing see page 9

**Contact specification**

Contact configuration

**34.51-xx10**



- 5 mm wide
- Low coil power
- PCB or 93 series sockets
- Contact AgNi

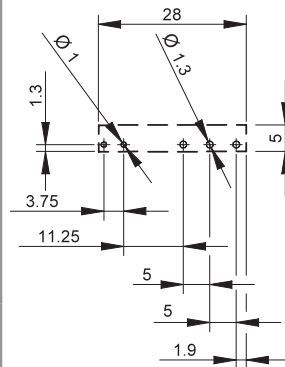
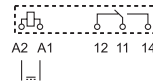

Copper side view

**34.51-5x10**



- 5 mm wide
- Low coil power
- PCB or 93 series sockets
- Contact AgNi + Au

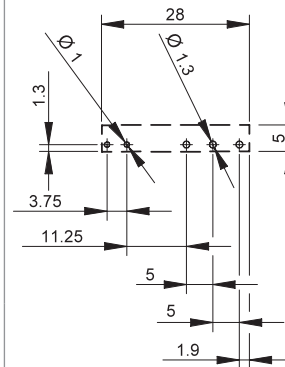
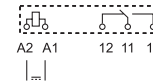

Copper side view

**34.51- 0000**



- 5 mm wide
- Low coil power
- PCB only
- Contact AgSnO<sub>2</sub>

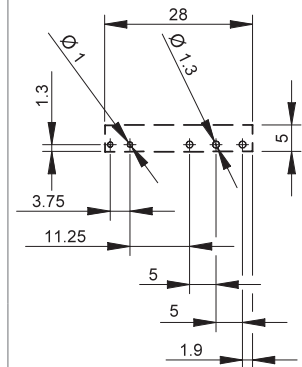
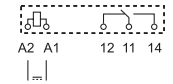

Copper side view

**Coil specification**

Nominal voltage (U<sub>N</sub>)

V AC (50/60 Hz)

—

—

—

V DC

5 - 12 - 24 - 48 - 60

5 - 12 - 24 - 48 - 60

12 - 24

Rated power AC/DC

VA (50 Hz)/W

—/0.17

—/0.17

—/0.17

Operating range

AC

—

—

—

DC

(0.7...1.5)U<sub>N</sub>

(0.7...1.5)U<sub>N</sub>

(0.7...1.5)U<sub>N</sub>

Holding voltage

AC/DC

—/0.4 U<sub>N</sub>

—/0.4 U<sub>N</sub>

—/0.4 U<sub>N</sub>

Must drop-out voltage

AC/DC

—/0.05 U<sub>N</sub>

—/0.05 U<sub>N</sub>

—/0.05 U<sub>N</sub>

**Technical data**

Mechanical life AC/DC

cycles

—/10 · 10<sup>6</sup>

—/10 · 10<sup>6</sup>

—/10 · 10<sup>6</sup>

Electrical life at rated load AC1

cycles

60 · 10<sup>3</sup>

60 · 10<sup>3</sup>

60 · 10<sup>3</sup>

Operate/release time

ms

5/3

5/3

5/3

Insulation between coil and contacts (1.2/50 μs)

kV

6 (8 mm)

6 (8 mm)

6 (8 mm)

Dielectric strength between open contacts

V AC

1000

1000

1000

Ambient temperature range

°C

−40...+85

−40...+85

−40...+85

Environmental protection

RT II

RT II

RT III

**Approvals** (according to type)



**Ultra-slim Solid State Relays**

**Printed circuit mount**

- direct or via PCB socket

**35 mm rail mount**

- via screw, screwless or push-in terminal sockets

- Single circuit output switching options
  - 6 A, 24 V DC
  - 2 A, 240 V AC
- Silent, high speed switching with long electrical life
- Ultra slim (5 mm), package
- Sensitive DC Input circuits (Dual AC/DC input drive possible using 93 series sockets)
- UL Listing (certain relay/socket combinations)
- Wash tight: RT III
- 3000 V AC insulation, input-output

**NEW 34.81.7.xxx.9024**



- 6 A, 24 V DC output switching
- PCB or 93 series sockets

**34.81.7.xxx.8240**



- 2 A, 240 V AC output switching
- Zero crossing switching
- PCB or 93 series sockets

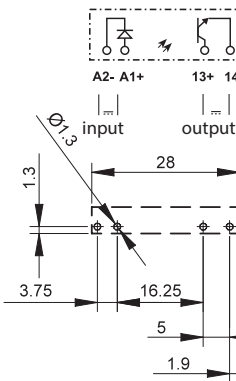

Copper side view

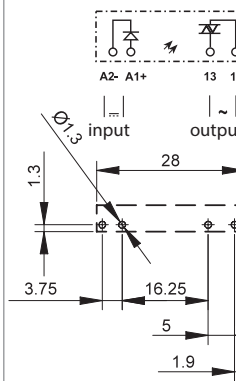

Copper side view

For outline drawing see page 9

**Output circuit**

Contact configuration		1 NO (SPST-NO)	1 NO (SPST-NO)
Rated current/ Maximum peak current (10 ms)	A	6/50	2/80
Rated switching voltage	V	24 DC	240 AC (50/60 Hz)
Switching voltage range	V	(1.5...33)DC	(12...275)AC
Maximum blocking voltage	V	33	—
Repetitive peak off-state voltage	V <sub>pk</sub>	—	800
Rated load DC13	W	36	—
Rated load AC15	VA	—	300
Minimum switching current	mA	1	35
Max. "OFF-state" leakage current	mA	0.001	1.5
Max. "ON-state" voltage drop	V	0.4	1.6

**Supply specification**

Nominal voltage (U <sub>N</sub> )	V DC	5	12	24	60	5	12	24	60
Rated power	W	0.035	0.085	0.17	0.21	0.06	0.085	0.17	0.21
Operating range	V DC	35...12	8...17	16...30	35...72	35...10	8...17	16...30	35...72
Control current	mA	7	7	7	3.5	12	7	7	3.5
Release voltage	V DC	4	4	10	20	1	4	10	20

**Technical data**

Electrical life at rated load	cycles	> 10 <sup>6</sup>				> 10 <sup>6</sup>			
Operate/release time	ms	0.02/0.2				11/11			
Insulation between input and output (1.2/50μs)	kV	4				4			
Ambient temperature range	°C	-20...+70*				-20...+50*			
Environmental protection		RT III				RT III			

**Approvals** (according to type)



\* Note: all technical data relates to using the relay directly on PCB or PCB socket type 93.11.  
If the relay is used with 35 mm rail socket types 93.01 and 93.51, refer to the technical data of 38 Series; if used with types 93.60, 93.61, 93.62, 93.63, 93.64, 93.65, 93.66, 93.67, 93.68 and 93.69, refer to the technical data of the MasterINTERFACE 39 Series. See L34 diagrams page 8

**Ultra-slim Solid State Relays**

**Printed circuit mount**

- direct or via PCB socket

**35 mm rail mount**

- via screw, screwless or push-in terminal sockets

- Single circuit output switching options
  - 0.1 A, 48 V DC
  - 0.2 A, 220 V DC
- Silent, high speed switching with long electrical life
- Ultra slim (5 mm), package
- Sensitive DC Input circuits (Dual AC/DC input drive possible using 93 series sockets)
- UL Listing (certain relay/socket combinations)
- Wash tight: RT III
- 3000 V AC insulation, input-output

**34.81.7.xxx.7048**

**NEW 34.81.7.xxx.7220**

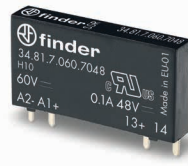

- 100 mA, 48 V DC output switching
- PCB or 93 series sockets

- 200 mA, 110/220 V DC output switching
- PCB or 93 series sockets

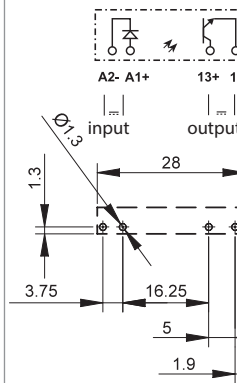
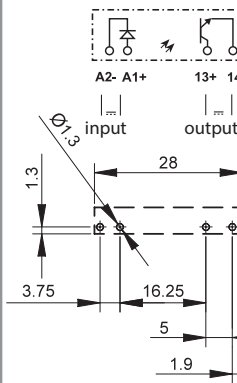

Copper side view

Copper side view

For outline drawing see page 9

**Output circuit**

Contact configuration		1 NO (SPST-NO)	1 NO (SPST-NO)
Rated current/ Maximum peak current (10 ms)	A	0.1/0.5	0.2/10
Rated switching voltage	V	48 DC	220 DC
Switching voltage range	V	(1.5...53)DC	(90...256)DC
Maximum blocking voltage	V	53	256
Rated load DC13	W	2.4	44
Minimum switching current	mA	0.05	0.05
Max. "OFF-state" leakage current	mA	0.001	0.001
Max. "ON-state" voltage drop	V	1	0.4

**Supply specification**

Nominal voltage (U <sub>N</sub> )	V DC	24	60	24	60
Rated power	W	0.17	0.21	0.17	0.21
Operating range	V DC	16...30	35...72	16...30	35...72
Control current	mA	7	3.5	7	3.5
Release voltage	V DC	10	20	10	20

**Technical data**

Electrical life at rated load	cycles	> 10 <sup>6</sup>	> 10 <sup>6</sup>
Operate/release time	ms	0.03/0.6	0.4/2.2
Insulation between input and output (1.2/50μs)	kV	4	4
Ambient temperature range	°C	-20...+70*	-20...+70*
Environmental protection		RT III	RT III

**Approvals (according to type)**



\* Note: all technical data relates to using the relay directly on PCB or PCB socket type 93.11.  
If the relay is used with 35 mm rail socket types 93.01 and 93.51, refer to the technical data of 38 Series; if used with types 93.60, 93.61, 93.62, 93.63, 93.64, 93.65, 93.66, 93.67, 93.68 and 93.69, refer to the technical data of the MasterINTERFACE 39 Series.

## Ordering information

### Electromechanical relay (EMR)

Example: 34 series Ultra-Slim electromechanical relay, 1 CO (SPDT) 6 A contacts, 24 V sensitive DC coil.

A

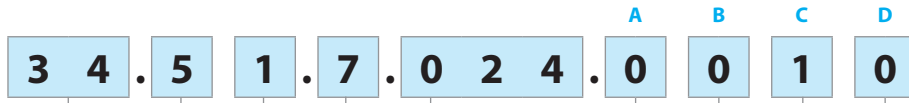

**Series** — 34

**Type** — 5 = Electromechanical type

**No. of poles** — 1 = 1 pole, 6 A

**Coil version** — 7 = Sensitive DC

**Coil voltage** — See coil specifications

**A: Contact material**  
 0 = Standard AgNi,  
 Standard AgSnO<sub>2</sub>  
 (for 34.51-0000 only)  
 4 = AgSnO<sub>2</sub>  
 5 = AgNi + Au

**B: Contact circuit**  
 0 = CO (SPDT)  
 3 = NO (SPST)

**D: Special versions**  
 0 = Standard version  
 9 = Flat version

**C: Options**  
 0 = Wash tight RT III  
 1 = Flux proof RT II

**Selecting features and options: only combinations in the same row are possible.**

Preferred selections for best availability are shown in **bold**.

Type	Coil version	A	B	C	D
34.51	sens. DC	<b>0</b> - 4 - 5	<b>0</b> - 3	<b>0</b> - 1	<b>0</b>
34.51	sens. DC	0 - 4 - 5	0	1	9

### Solid state relay (SSR)

Example: 34 series solid state relay, 6 A 24 V DC output, 24 V DC supply.



**Series** — 34

**Type** — 8 = SSR type

**Output** — 1 = 1 NO (SPST-NO)

**Input circuit** — See input specifications

**Output circuit**  
 9024 = 6 A - 24 V DC  
 7048 = 0.1 A - 48 V DC  
 7220 = 0.2 A - 220 V DC  
 8240 = 2 A - 240 V AC

## Flat pack version



Option = 34.51.7xxx.x019

Environmental protection RT I

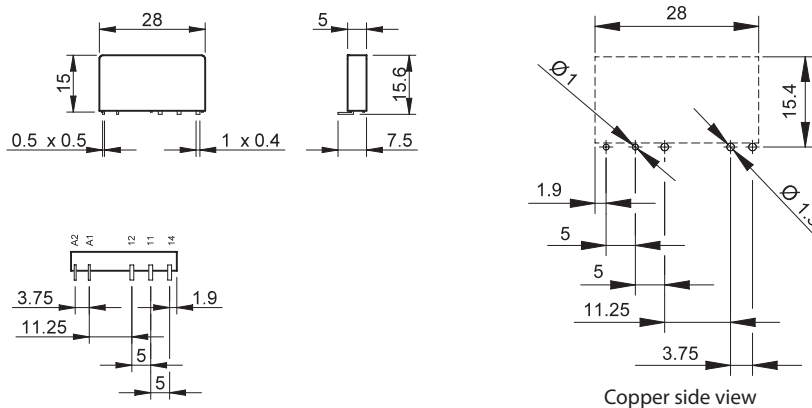

## Electromechanical relay

A

### Technical data

Insulation according to EN 61810-1			
Nominal voltage of supply system	V AC	230/400	
Rated insulation voltage	V AC	250	400
Pollution degree		3	2
Insulation between coil and contact set			
Type of insulation		Reinforced	
Overtoltage category		III	
Rated impulse voltage	kV (1.2/50 $\mu$ s)	6	
Dielectric strength	V AC	4000	
Insulation between open contacts			
Type of disconnection		Micro-disconnection	
Dielectric strength	V AC/kV (1.2/50 $\mu$ s)	1000/1.5	
Insulation between coil terminals			
Rated impulse voltage (surge) differential mode (according to EN 61000-4-5)	kV (1.2/50 $\mu$ s)	2	
Other data			
Bounce time: NO/NC	ms	1/6	
Vibration resistance (5...55)Hz: NO/NC	g	10/5	
Shock resistance	g	20/14	
Power lost to the environment	without contact current	W	0.2
	with rated current	W	0.5
Recommended distance between relays mounted on PCB	mm	$\geq 5$	

### Contact specification

F 34 - Electrical life (AC) v contact current

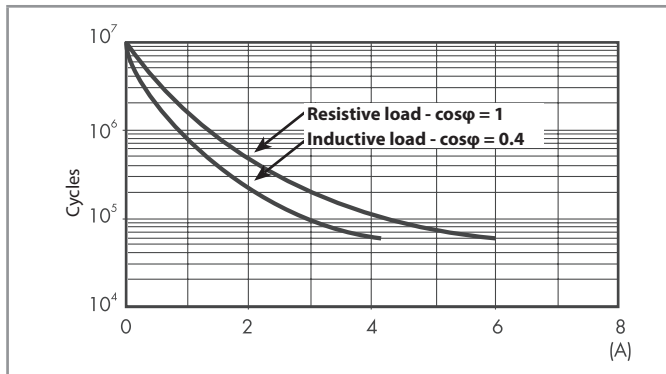

H 34 - Maximum DC1 breaking capacity

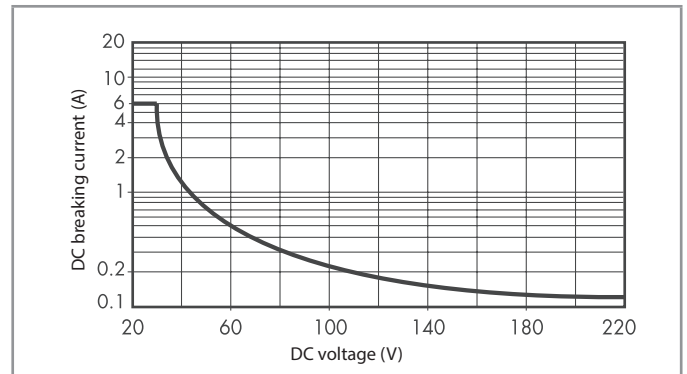

- When switching a resistive load (DC1) having voltage and current values under the curve, an electrical life of  $\geq 60 \cdot 10^3$  can be expected.
- In the case of DC13 loads, the connection of a diode in parallel with the load will permit a similar electrical life as for a DC1 load.  
Note: the release time for the load will be increased.

### Coil specifications

#### DC coil data

Nominal voltage	Coil code	Operating range		Resistance	Rated coil consumption
		$U_{min}$	$U_{max}$		
V		V	V	$\Omega$	mA
5	7.005	3.5	7.5	130	38.4
12	7.012	8.4	18	840	14.2
24	7.024	16.8	36	3350	7.1
48	7.048	33.6	72	12300	3.9
60	7.060	42	90	19700	3

R 34 - DC coil operating range v ambient temperature

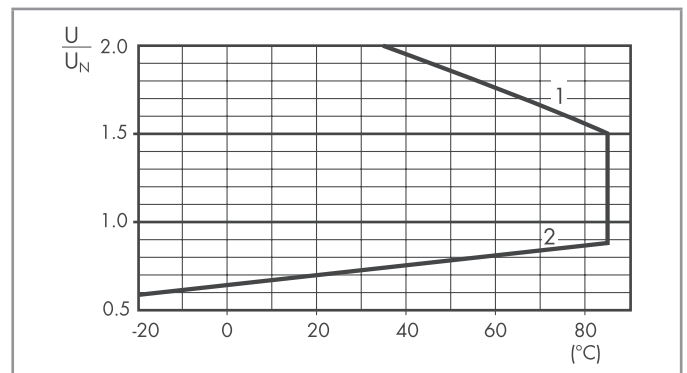

- 1 - Max. permitted coil voltage.
- 2 - Min. pick-up voltage with coil at ambient temperature.

Solid state relay

Technical data

A

Insulation		Dielectric strength	Impulse (1.2/50 µs)
Between input and output		3000 V AC	4 kV
EMC specifications		Reference standard	
Electrostatic discharge	contact discharge	EN 61000-4-2	4 kV
	air discharge	EN 61000-4-2	8 kV
Radiated electromagnetic field (80...1000 MHz)		EN 61000-4-3	10 V/m
Fast transients on supply terminals (burst 5/50 ns, 5 and 100 kHz)		EN 61000-4-4	2 kV
Voltage pulses on supply terminals (surge 1.2/50 µs)	common mode	EN 61000-4-5	0.7 kV
	differential mode	EN 61000-4-5	0.7 kV*
Radio-frequency common mode voltage (0.15...230 MHz)		EN 61000-4-6	10 V
Other data			
Power lost to the environment	without output current	W	0.15
	with rated current	W	0.4

\* For 34.81.7.005... = 0.3 kV; for 34.81.7.012... = 0.5 kV

Input specification

Input data - DC types

Nominal voltage $U_N$ V	Input code	Operating range		Release voltage V	Impedance $\Omega$	Control current I at $U_N$ mA
		$U_{min}$ V	$U_{max}$ V			
5	7.005	3.5	12*	1	715	7*
12	7.012	8	17	4	1715	7
24	7.024	16	30	10	3430	7
60	7.060	35	72	20	17000	3.5

\* For 34.81.7.005.8240:  $U_{MAX} = 10 V$ , I @ 5 V = 12 mA

Output specification

L 34-1 - Output DC current v ambient temperature

34.81.7...9024

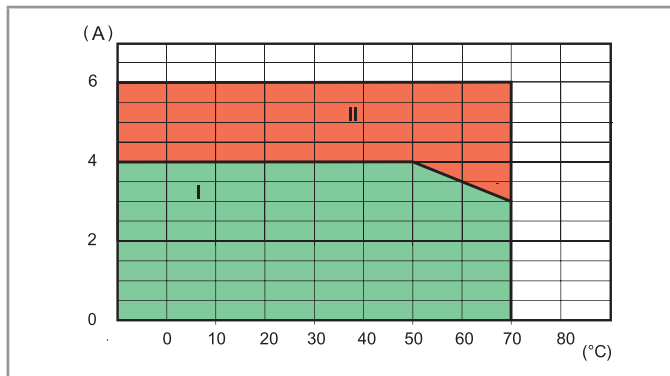

L 34 - Output AC current v ambient temperature

34.81.7...8240

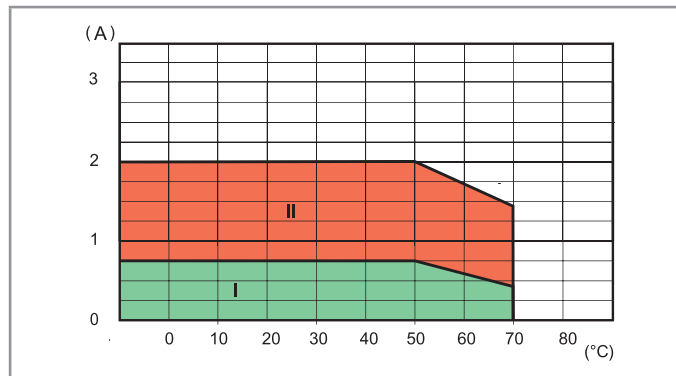

I: SSR installed on 93 series sockets as a group (without gap between sockets)

II: SSR installed individually in free air, or with a gap  $\geq 9$  mm, which implies a not significant influence from nearby components

Max recommended switching frequency (Cycles/Hour, with 50% Duty-cycle) at ambient temperature 50°C, single mounting

Load	34.81.7xxx.9024	34.81.7xxx.8240	34.81.7xxx.7048	34.81.7xxx.7220
24 V 6 A DC1	180 000	—	—	—
24 V 3 A DC L/R = 10 ms	5000	—	—	—
24 V 2 A DC L/R = 40 ms	3600	—	—	—
24 V 1 A DC L/R = 40 ms	6500	—	—	—
24 V 0.8 A DC L/R = 40 ms	9000	—	—	—
24 V 1.5 A DC L/R = 80 ms	3250	—	—	—
230 V 2 A AC1	—	60 000	—	—
230 V 1.25 A AC15	—	3600	—	—
48 V 0.1 A DC1	—	—	60 000	—
220 V 0.2 A DC1	—	—	—	60 000

### Outline drawings

Type 34.51

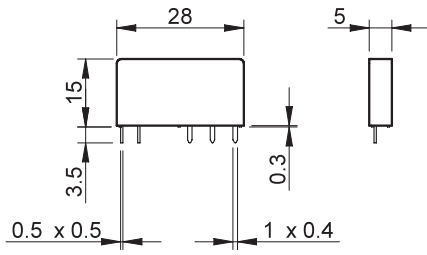

Type 34.81

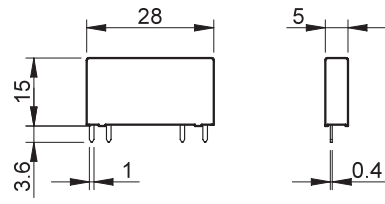

A

A

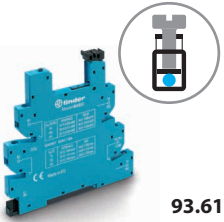

93.61

**Screw terminal socket** 35 mm rail mounting (EN 60715)

**Common features**

- Space saving 6.2 mm wide
- Connections for 16-way jumper link
- Integral coil indication and protection circuit
- Secure retention and easy ejection by plastic clip
- Dual screw head (blade+cross) terminals

For technical data and supply versions, refer to the Master **INTERFACE 39 Series** – “Relay interface module”

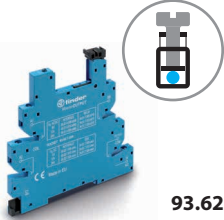

93.62

**Electromechanical Relay - EMR**

Supply voltage	Relay type	Socket type (reference with the 39 Series)				
		Master <b>BASIC</b> (39.11...)	Master <b>PLUS</b> (39.31...)	Master <b>INPUT</b> (39.41...)	Master <b>OUTPUT</b> (39.21...)	Master <b>TIMER</b> (39.81...)
6 V AC/DC	34.51.7.005.xx10	93.61.7.024	93.63.7.024	93.64.7.024	93.62.7.024	—
12 V AC/DC	34.51.7.012.xx10	93.61.7.024	93.63.7.024	93.64.7.024	93.62.7.024	93.68.0.024
24 V AC/DC	34.51.7.024.xx10	93.61.7.024	93.63.7.024	93.64.7.024	93.62.7.024	93.68.0.024
60 V AC/DC	34.51.7.060.xx10	—	93.63.7.060	—	—	—
(110...125)V AC/DC*	34.51.7.060.xx10	—	93.63.3.125	—	—	—
(220...240)V AC*	34.51.7.060.xx10	—	93.63.3.230	—	—	—
(110...125)V AC/DC	34.51.7.060.xx10	93.61.0.125	93.63.0.125	93.64.0.125	93.62.0.125	—
(24...240)V AC/DC	34.51.7.024.xx10	—	93.63.0.240	—	—	—
(220...240)V AC	34.51.7.060.xx10	93.61.8.230	93.63.8.230	93.64.8.230	93.62.8.230	—
(110...125)V DC	34.51.7.060.xx10	—	93.63.7.125	—	—	—
220 V DC	34.51.7.060.xx10	—	93.63.7.220	—	—	—

\* Leakage current suppression

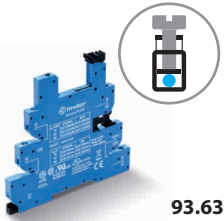

93.63

**Solid State Relay - SSR**



93.64

Supply voltage	Relay type	Socket type (reference with the 39 Series)				
		Master <b>BASIC</b> (39.10...)	Master <b>PLUS</b> (39.30...)	Master <b>INPUT</b> (39.40...)	Master <b>OUTPUT</b> (39.20...)	Master <b>TIMER</b> (39.80...)
12 V AC/DC	34.81.7.012.xxxx	—	—	—	—	93.68.0.024
24 V AC/DC	34.81.7.024.xxxx	—	93.63.0.024	93.64.0.024	—	93.68.0.024
(110...125)V AC/DC*	34.81.7.060.xxxx	—	93.63.3.125	—	—	—
(220...240)V AC*	34.81.7.060.xxxx	—	93.63.3.230	—	—	—
(110...125)V AC/DC	34.81.7.060.xxxx	93.61.0.125	93.63.0.125	93.64.0.125	93.62.0.125	—
(24...240)V AC/DC	34.81.7.024.xxxx	—	93.63.0.240	—	—	—
(220...240)V AC	34.81.7.060.xxxx	93.61.8.230	93.63.8.230	93.64.8.230	93.62.8.230	—
6 V DC	34.81.7.005.xxxx	93.61.7.024	93.63.7.024	93.64.7.024	93.62.7.024	—
12 V DC	34.81.7.012.xxxx	93.61.7.024	93.63.7.024	93.64.7.024	93.62.7.024	—
24 V DC	34.81.7.024.xxxx	93.61.7.024	93.63.7.024	93.64.7.024	93.62.7.024	—
60 V DC	34.81.7.060.xxxx	—	93.63.7.060	—	—	—
(110...125)V DC	34.81.7.060.xxxx	—	93.63.7.125	—	—	—
220 V DC	34.81.7.060.xxxx	—	93.63.7.220	—	—	—

\* Leakage current suppression

Approvals  
(according to type):



**Accessories**

16-way jumper link	093.16 (blue), 093.16.0 (black), 093.16.1 (red)
Dual-purpose plastic separator	093.60
Sheet of marker tags	060.48 and 093.48

**Technical data**

Rated values	6 A - 250 V
Dielectric strength	6 kV (1.2/50 μs) between coil and contacts
Protection category	IP 20
Ambient temperature	°C -40...+70
Screw torque	Nm 0.5
Wire strip length	mm 10
Max wire size	Solid wire and stranded wire
	mm <sup>2</sup> 1 x (0.5...2.5) / 2 x 1.5
	AWG 1 x (21...14) / 2 x 16



**Push-In terminal socket** 35 mm rail mounting (EN 60715)

**Common features**

- Space saving 6.2 mm wide
- Connections for 16-way jumper link
- Terminal doubler 093.62
- Integral coil indication and protection circuit
- Secure retention and easy ejection by plastic clip



93.60

For technical data and supply versions, refer to the Master**INTERFACE 39 Series** – “Relay interface module”



**Electromechanical Relay - EMR**



93.65

Supply voltage	Relay type	Socket type (reference with the 39 Series)				
		Master <b>BASIC</b> (39.01...)	Master <b>PLUS</b> (39.61...)	Master <b>INPUT</b> (39.71...)	Master <b>OUTPUT</b> (39.51...)	Master <b>TIMER</b> (39.91...)
6 V AC/DC	34.51.7.005.xx10	93.60.7.024	93.66.7.024	93.67.7.024	93.65.7.024	—
12 V AC/DC	34.51.7.012.xx10	93.60.7.024	93.66.7.024	93.67.7.024	93.65.7.024	93.69.0.024
24 V AC/DC	34.51.7.024.xx10	93.60.7.024	93.66.7.024	93.67.7.024	93.65.7.024	93.69.0.024
60 V AC/DC	34.51.7.060.xx10	—	93.66.7.060	—	—	—
(110...125)V AC/DC*	34.51.7.060.xx10	—	93.66.3.125	—	—	—
(220...240)V AC*	34.51.7.060.xx10	—	93.66.3.230	—	—	—
(110...125)V AC/DC	34.51.7.060.xx10	93.60.0.125	93.66.0.125	93.67.0.125	93.65.0.125	—
(24...240)V AC/DC	34.51.7.024.xx10	—	93.66.0.240	—	—	—
(220...240)V AC	34.51.7.060.xx10	93.60.8.230	93.66.8.230	93.67.8.230	93.65.8.230	—
(110...125)V DC	34.51.7.060.xx10	—	93.66.7.125	—	—	—
220 V DC	34.51.7.060.xx10	—	93.66.7.220	—	—	—

\* Leakage current suppression



93.66

**Solid State Relay - SSR**



93.67

Supply voltage	Relay type	Socket type (reference with the 39 Series)				
		Master <b>BASIC</b> (39.00...)	Master <b>PLUS</b> (39.60...)	Master <b>INPUT</b> (39.70...)	Master <b>OUTPUT</b> (39.50...)	Master <b>TIMER</b> (39.90...)
12 V AC/DC	34.81.7.012.xxxx	—	—	—	—	93.69.0.024
24 V AC/DC	34.81.7.024.xxxx	—	93.66.0.024	93.67.0.024	—	93.69.0.024
(110...125)V AC/DC*	34.81.7.060.xxxx	—	93.66.3.125	—	—	—
(220...240)V AC*	34.81.7.060.xxxx	—	93.66.3.230	—	—	—
(110...125)V AC/DC	34.81.7.060.xxxx	93.60.0.125	93.66.0.125	93.67.0.125	93.65.0.125	—
(24...240)V AC/DC	34.81.7.024.xxxx	—	93.66.0.240	—	—	—
(220...240)V AC	34.81.7.060.xxxx	93.60.8.230	93.66.8.230	93.67.8.230	93.65.8.230	—
6 V DC	34.81.7.005.xxxx	93.60.7.024	93.66.7.024	93.67.7.024	93.65.7.024	—
12 V DC	34.81.7.012.xxxx	93.60.7.024	93.66.7.024	93.67.7.024	93.65.7.024	—
24 V DC	34.81.7.024.xxxx	93.60.7.024	93.66.7.024	93.67.7.024	93.65.7.024	—
60 V DC	34.81.7.060.xxxx	—	93.66.7.060	—	—	—
(110...125)V DC	34.81.7.060.xxxx	—	93.66.7.125	—	—	—
220 V DC	34.81.7.060.xxxx	—	93.66.7.220	—	—	—

\* Leakage current suppression



93.69

Approvals  
(according to type):



Accessories	
16-way jumper link	093.16 (blue), 093.16.0 (black), 093.16.1 (red)
Dual-purpose plastic separator	093.60
Terminal doubler	093.62
Sheet of marker tags	060.48 and 093.48
Technical data	
Rated values	6 A - 250 V
Dielectric strength	6 kV (1.2/50 μs) between coil and contacts
Protection category	IP 20
Ambient temperature	°C -40...+70
Wire strip length	mm 8
Max wire size	Solid wire and stranded wire
	mm <sup>2</sup> 1 x (0.5...2.5)
	AWG 1 x (21...14)

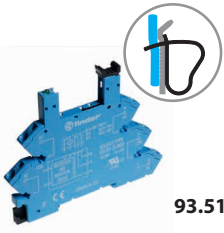

93.51

**Screw less terminal socket 35 mm rail mounting (EN 60715)****Common features**

- Space saving 6.2 mm wide
- Connections for 20-way jumper link
- Integral coil indication and protection circuit
- Secure retention and easy ejection by plastic clip

For technical data and supply versions, refer to the **38 Series** – “Relay interface module”Approvals  
(according to type):RINA cRU<sup>®</sup> US
 Certain relay/socket combinations
**Electromechanical Relay - EMR and Solid State Relay - SSR**

Supply voltage	Relay type (reference with the 38 Series)		Socket type
	Electromechanical relay - EMR (38.61...)	Solid State Relay - SSR (38.81...)	
12 V AC/DC	34.51.7.012.xx10	—	93.51.0.024
24 V AC/DC	34.51.7.024.xx10	—	93.51.0.024
(110...125)V AC/DC	34.51.7.060.xx10	34.81.7.060.xxxx	93.51.0.125
(220...240)V AC/DC	34.51.7.060.xx10	34.81.7.060.xxxx	93.51.0.240
(110...125)V AC/DC*	34.51.7.060.xx10	34.81.7.060.xxxx	93.51.3.125
(220...240)V AC*	34.51.7.060.xx10	34.81.7.060.xxxx	93.51.3.240
(220...240)V AC	34.51.7.060.xx10	34.81.7.060.xxxx	93.51.8.240
12 V DC	34.51.7.012.xx10	34.81.7.012.xxxx	93.51.7.024
24 V DC	34.51.7.024.xx10	34.81.7.024.xxxx	93.51.7.024
60 V DC	34.51.7.060.xx10	34.81.7.060.xxxx	93.51.7.060

\* Leakage current suppression

**Accessories**

20-way jumper link	093.20
Plastic separator	093.01
Sheet of marker tags	093.48

**Technical data**

Rated values	6 A - 250 V
Dielectric strength	6 kV (1.2/50 μs) between coil and contacts
Protection category	IP 20
Ambient temperature ( $U_N \leq 60$ V / $> 60$ V)	°C -40...+70 / -40...+55
Wire strip length	mm 10
Max wire size	Solid wire and stranded wire
	mm <sup>2</sup> 1 x 2.5 / 2 x 1.5
	AWG 1 x 14 / 2 x 16



93.11

Approvals  
(according to type):



<b>PCB socket with retaining and release clip</b>	<b>93.11 (blue)</b>
For relay type	34.51, 34.81
<b>Technical data</b>	
Rated values	6 A - 250 V
Dielectric strength	≥ 6 kV (1.2/50 μs) between coil and contacts
Protection category	IP 20
Ambient temperature	°C -40...+70

A

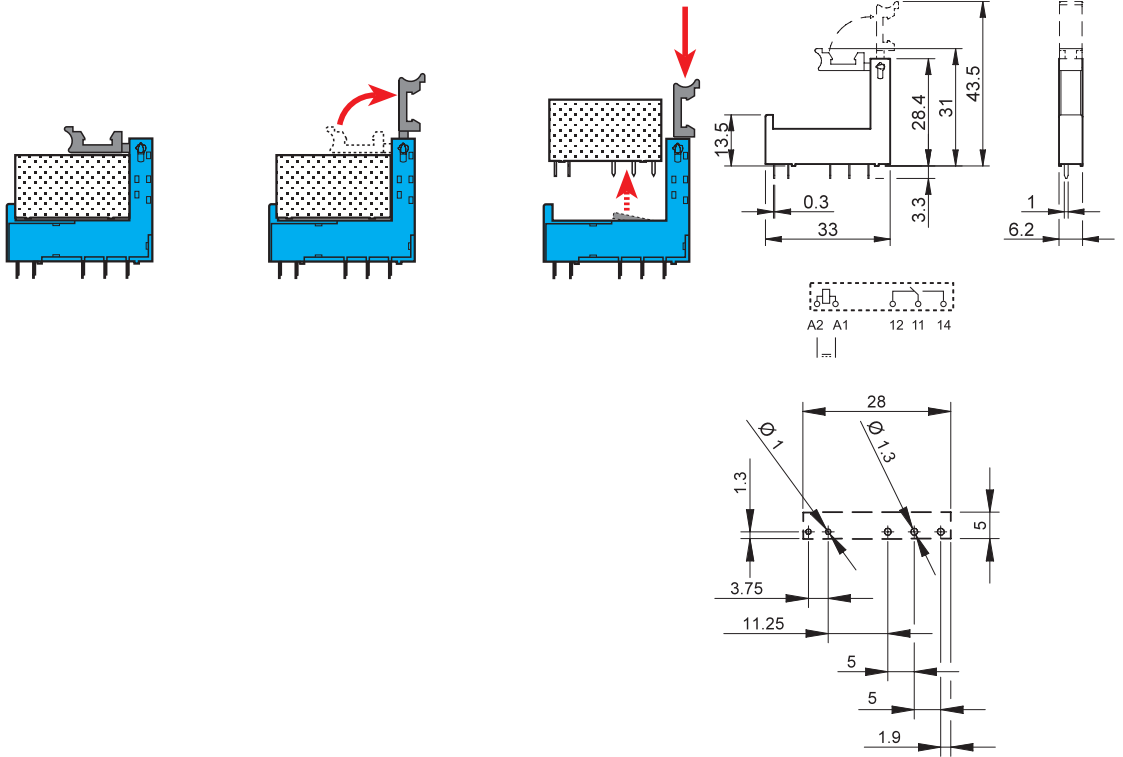

**Retaining and release clip use:**





## Looking for pricing, stock, or lifecycle information?

Click below to explore more details on WIN SOURCE:

-  [View 34.51.7.005.0010 on WIN SOURCE](#)
-  [Finder Relays, Inc. Information](#)

## Optimize Your Supply Chain with WIN SOURCE Solutions

-  Global Sourcing Solution
-  Obsolete Management
-  Cost Control Management
-  Shortage Management
-  Alternative Solution
-  Excess Inventory Management