



Notes:  
No. of Positions 64 with three key; Other positions with one key

TECHNICAL CHARACTERISTICS

MATERIAL  
INSULATOR: PBT  
FLAMABILITY RATING: UL94-V0  
COLOR: BLACK  
CONTACT MATERIAL: COPPER ALLOY  
CONTACT TYPE: STAMPED  
CONTACT PLATING: GOLD  
QUALITY CLASS: 3 AS PER CECC 75 301-802  
PITCH: 2.54 MM

ENVIRONMENTAL  
OPERATING TEMPERATURE: -40 UP TO 125°C  
COMPLIANCE: LEAD FREE AND ROHS

ELECTRICAL  
CURRENT RATING: 3A MAX  
WORKING VOLTAGE: 250 VAC  
INSULATOR RESISTANCE: >1000 MOHM  
DIELECTRIC WITHSTANDING VOLTAGE: 500 VAC/MM  
CONTACT RESISTANCE: 20 mOHM MAX

STANDARD  
CERTIFIED: E323964

SOLDERING  
JEDEC LEAD FREE WAVE SOLDERING PROCESS

PACKAGING  
TRAY

DIMENSION

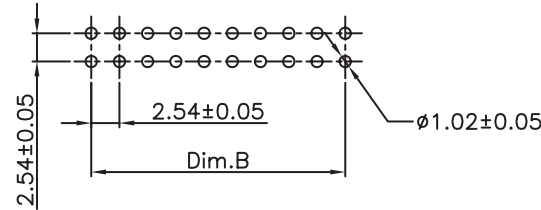

Recommended P.C.B Layout

Holes left and right appear from polarity 20

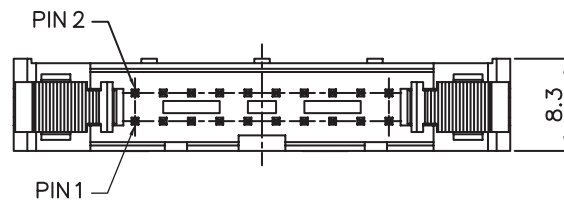
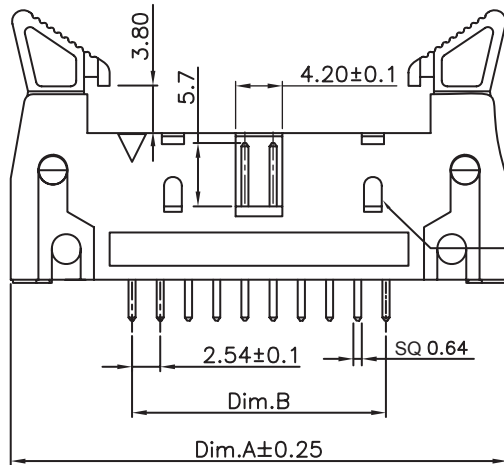
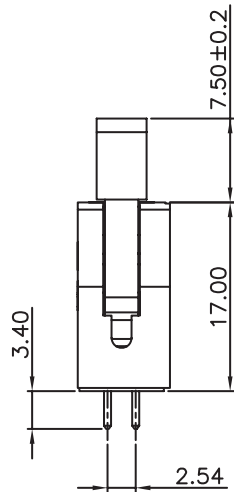

No. of Positions	Dim A	Dim B	No. of Positions	Dim A	Dim B
10	32.00	10.16	34	62.50	40.64
12	34.54	12.70	40	70.10	48.26
14	37.08	15.24	50	82.85	60.96
16	39.62	17.78	60	95.50	73.66
20	44.70	22.86			
24	49.78	27.94			
26	52.30	30.48			
30	57.40	35.56			

RoHS Compliant

PROJECTION:



GENERAL TOLERANCE

.X = +/- 0.2  
.XX = +/- 0.15



APPROVAL: GMo

UNIT: MM

SCALE:

SHEET: 1/3

DRAW: MIKE

DESCRIPTION: 2.54MM MALE BOX HEADER WITH SHORT LEVER

WERI PART NO: 612 0xx 220 21

SIZE

A4

REV	DATE	FILE	BY
K	26-JAN-16	TPK UPDATE	AK
J	22-SEP-15	NOTES	SBe
I	19-MAR-13	NOTES	AR
H	22-JAN-13	POLARITY REMOVE	QL

1

2

3

4

5

Note:

1.Dimension:

Tray Size:470(L)x270(W)x23(H) (mm)

Carton Size:470(L)x270(W)x350(H) (mm)

2.Quantity:

CIRCUITS	PCS/TRAY	TRAYS/CARTON	Q'TY
6	180	15	2700
8	168	15	2520
10	156	15	2340
14	132	15	1980
16	120	15	1800
20	108	15	1620
24-26	96	15	1440
30	84	15	1260
34-40	72	15	1080
50	60	15	900
60-64	48	15	720

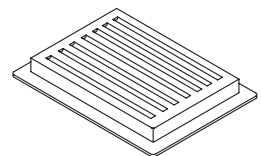
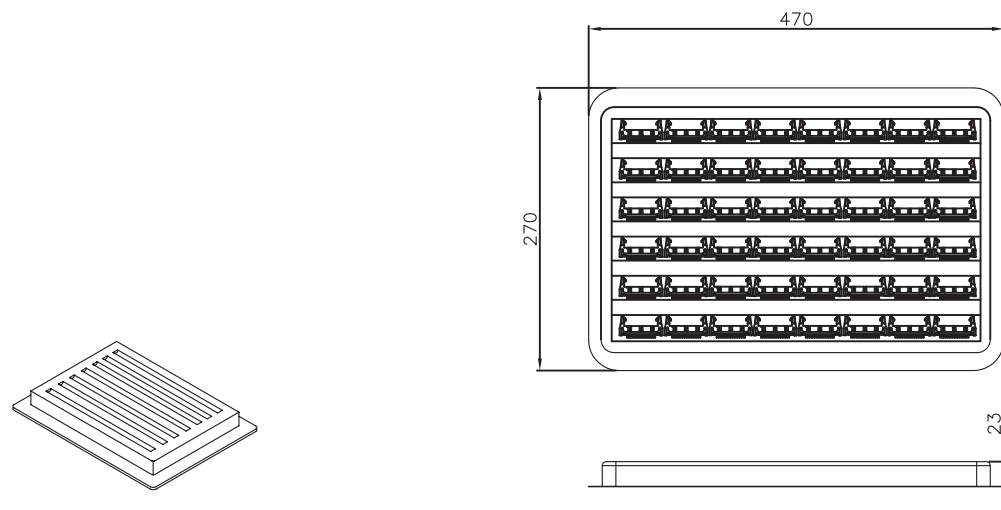

TRAY

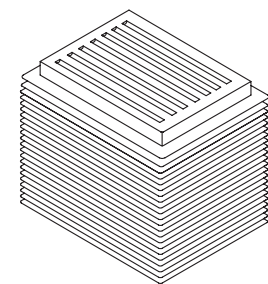

15TRAYS

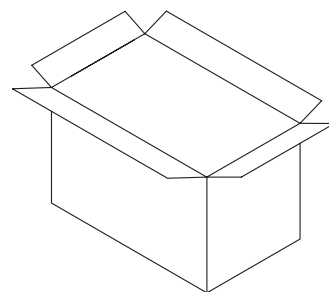

CARTON

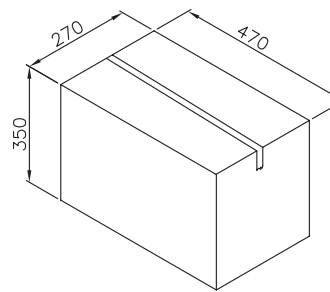

RoHS Compliant

PROJECTION:



GENERAL TOLERANCE

.X = +/- 0.2

.XX = +/- 0.15



APPROVAL: GMo

UNIT: MM

SCALE:

SHEET: 2/3

DRAW: PEARL

DESCRIPTION: 2.54MM MALE BOX HEADER WITH SHORT LEVER

WERI PART NO: 612 0xx 220 21

SIZE

A4

G							
F							
E							
D							
C							
B							
A							
REV	DATE	FILE	BY				

1

2

3

4

5

## Cautions and Warnings:

This electronic component is designed and developed with the intention for use in general electronics equipments.



Before incorporating the components into any equipments in the field such as aerospace, aviation, nuclear control, submarine, transportation, (automotive control, train control, ship control), transportation signal, disaster prevention, medical, public information network etc. where higher safety and reliability are especially required or if there is possibility of direct damage or injury to human body, Würth Elektronik must be asked for a written approval.

In addition, even electronic component in general electronic equipments, when used in electrical circuits that require high safety, reliability functions or performance, the sufficient reliability evaluation-check for the safety must be performed before by the user before usage.

A

B

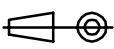
C

RoHS Compliant				PROJECTION: 	GENERAL TOLERANCE .X = +/- 0.2 .XX = +/- 0.15	 <b>WÜRTH ELEKTRONIK</b>	DESCRIPTION: DISCLAIMER	SIZE <b>A4</b>
G								
F								
E								
D								
C				APPROVAL: JC	UNIT: MM	WERI PART NO: DISCLAIMER	SIZE <b>A4</b>	
B				SCALE:				
A	10-SEP-14	PDF	QL	SHEET: 3/3				
REV	DATE	FILE	BY	DRAW: QL				

D

## Looking for pricing, stock, or lifecycle information?

Click below to explore more details on WIN SOURCE:

 [View 61201022021 on WIN SOURCE](#)

 [Wurth Electronics Inc Information](#)

## Optimize Your Supply Chain with WIN SOURCE Solutions

-  Global Sourcing Solution
-  Obsolete Management
-  Cost Control Management
-  Shortage Management
-  Alternative Solution
-  Excess Inventory Management