



**THE DATASHEET OF
DS36C278M/NOPB**



DS36C278 Low Power Multipoint EIA-RS-485 Transceiver

Check for Samples: [DS36C278](#)

FEATURES

- **100% RS-485 Compliant**
 - **Guaranteed RS-485 Device Interoperation**
- **Low Power CMOS Design: I_{CC} 500 μ A Max**
- **Built-In Power Up/Down Glitch-Free Circuitry**
 - **Permits Live Transceiver Insertion/Displacement**
- **PDIP and SOIC Packages Available**
- **Industrial Temperature Range: -40°C to $+85^{\circ}\text{C}$**
- **On-Board Thermal Shutdown Circuitry**
 - **Prevents Damage to the Device in the Event of Excessive Power Dissipation**
- **Wide Common Mode Range: -7V to $+12\text{V}$**
- **Receiver Open Input Fail-Safe ⁽¹⁾**
- **$\frac{1}{4}$ Unit Load (DS36C278): ≥ 12 Nodes**
- **$\frac{1}{2}$ Unit Load (DS36C278T): ≥ 64 Nodes**
- **ESD (Human Body Model): ≥ 2 kV**
- **Drop in Replacement for:**
 - **LTC485, MAX485, DS75176, DS3695**

⁽¹⁾ Non-terminated, open input only

Connection Diagram

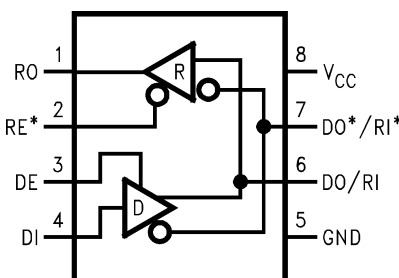

Figure 1. 8-Pin PDIP or SOIC Package Numbers D0008A and P0008E

DESCRIPTION

The DS36C278 is a low power differential bus/line transceiver designed to meet the requirements of RS-485 standard for multipoint data transmission. In addition it is compatible with TIA/EIA-422-B.

The CMOS design offers significant power savings over its bipolar and ALS counterparts without sacrificing ruggedness against ESD damage. The device is ideal for use in battery powered or power conscious applications. I_{CC} is specified at 500 μ A maximum.

The driver and receiver outputs feature TRI-STATE capability. The driver outputs operate over the entire common mode range of -7V to $+12\text{V}$. Bus contention or fault situations that cause excessive power dissipation within the device are handled by a thermal shutdown circuit, which forces the driver outputs into the high impedance state.

The receiver incorporates a fail safe circuit which guarantees a high output state when the inputs are left open. ⁽¹⁾

The DS36C278T is fully specified over the industrial temperature range (-40°C to $+85^{\circ}\text{C}$).



Please be aware that an important notice concerning availability, standard warranty, and use in critical applications of Texas Instruments semiconductor products and disclaimers thereto appears at the end of this data sheet.

All trademarks are the property of their respective owners.

Pin Descriptions

Pin No.	Name	Description
1	RO	Receiver Output: When RE (Receiver Enable) is LOW, the receiver is enabled (ON), if $DO/RI \geq DO^*/RI^*$ by 200 mV, RO will be HIGH. If $DO/RI \leq DO^*/RI^*$ by 200 mV, RO will be LOW. Additionally RO will be HIGH for OPEN (Non-terminated) Inputs.
2	RE*	Receiver Output Enable: When RE* is LOW the receiver output is enabled. When RE* is HIGH, the receiver output is in TRI-STATE (OFF).
3	DE	Driver Output Enable: When DE is HIGH, the driver outputs are enabled. When DE is LOW, the driver outputs are in TRI-STATE (OFF).
4	DI	Driver Input: When DE (Driver Enable) is HIGH, the driver is enabled, if DI is LOW, then DO/RI will be LOW and DO^*/RI^* will be HIGH. If DI is HIGH, then DO/RI is HIGH and DO^*/RI^* is LOW.
5	GND	Ground Connection.
6	DO/RI	Driver Output/Receiver Input, 485 Bus Pin.
7	DO^*/RI^*	Driver Output/Receiver Input, 485 Bus Pin.
8	V_{CC}	Positive Power Supply Connection: Recommended operating range for V_{CC} is +4.75V to +5.25V.

Table 1. Truth Table⁽¹⁾

DRIVER SECTION					
RE*	DE	DI	DO/RI	DO^*/RI^*	
X	H	H	H	L	
X	H	L	L	H	
X	L	X	Z	Z	
RECEIVER SECTION					
RE*	DE	RI-RI*		RO	
L	L	$\geq +0.2V$		H	
L	L	$\leq -0.2V$		L	
H	L	X		Z	
L	L	OPEN ⁽¹⁾		H	

(1) Non-terminated, open input only



These devices have limited built-in ESD protection. The leads should be shorted together or the device placed in conductive foam during storage or handling to prevent electrostatic damage to the MOS gates.

Absolute Maximum Ratings⁽¹⁾⁽²⁾

Supply Voltage (V_{CC})	+12V
Input Voltage (DE, RE*, & DI)	-0.5V to ($V_{CC} + 0.5V$)
Common Mode (V_{CM})	
Driver Output/Receiver Input	$\pm 15V$
Input Voltage (DO/RI , DO^*/RI^*)	$\pm 14V$
Receiver Output Voltage	-0.5V to ($V_{CC} + 0.5V$)
Maximum Package Power Dissipation	
@ +25°C	
D0008A Package 1190 mW, derate	9.5 mW/°C above +25°C
P0008E Package 744 mW, derate	6.0 mW/°C above +25°C
Storage Temperature Range	-65°C to +150°C
Lead Temperature (Soldering 4 sec)	+260°C

- (1) "Absolute Maximum Ratings" are those values beyond which the safety of the device cannot be guaranteed. They are not meant to imply that the devices should be operated at these limits. The table of "Electrical Characteristics" specifies conditions of device operation.
- (2) If Military/Aerospace specified devices are required, please contact the TI Sales Office/Distributors for availability and specifications.

Recommended Operating Conditions

	Min	Typ	Max	Units
Supply Voltage (V_{CC})	+4.75	+5.0	+5.25	V
Bus Voltage	-7		+12	V
Operating Free-Air Temperature (T_A)				
DS36C278T	-40	25	+85	°C
DS36C278	0	25	+70	°C

Electrical Characteristics ⁽¹⁾ ⁽²⁾

Over Supply Voltage and Operating Temperature ranges, unless otherwise specified

Parameter		Test Conditions	Reference	Min	Typ	Max	Units	
DIFFERENTIAL DRIVER CHARACTERISTICS								
V_{OD1}	Differential Output Voltage	$I_O = 0$ mA (No Load)	(422) (485)	1.5		5.0	V	
V_{OD0}	Output Voltage	$I_O = 0$ mA		0		5.0	V	
V_{OD0^*}	Output Voltage	(Output to GND)		0		5.0	V	
V_{OD2}	Differential Output Voltage (Termination Load)	$R_L = 50\Omega$	(422)	Figure 2	2.0	2.8	V	
		$R_L = 27\Omega$	(485)		1.5	2.3	5.0	V
ΔV_{OD2}	Balance of V_{OD2} $ V_{OD2} - V_{OD2^*} $	$R_L = 27\Omega$ or 50Ω	(3)		-0.2	0.1	+0.2	V
			(422, 485)					
V_{OD3}	Differential Output Voltage (Full Load)	$R1 = 54\Omega$, $R2 = 375\Omega$ $V_{TEST} = -7V$ to $+12V$	Figure 3		1.5	2.0	5.0	V
V_{OC}	Driver Common Mode Output Voltage	$R_L = 27\Omega$	(485)	Figure 2	0		3.0	V
		$R_L = 50\Omega$	(422)		0		3.0	V
ΔV_{OC}	Balance of V_{OC} $ V_{OC} - V_{OC^*} $	$R_L = 27\Omega$ or $R_L = 50\Omega$	(3) (422, 485)		-0.2		+0.2	V
I_{OSD}	Driver Output Short-Circuit Current	$V_O = +12V$	(485)			200	+250	mA
		$V_O = -7V$	(485)			-190	-250	mA
RECEIVER CHARACTERISTICS								
V_{TH}	Differential Input High Threshold Voltage	$V_O = V_{OH}$, $I_O = -0.4V$ $-7V \leq V_{CM} \leq +12V$	(4)			+0.035	+0.2	V
V_{TL}	Differential Input Low Threshold Voltage	$V_O = V_{OL}$, $I_O = 0.4$ mA $-7V \leq V_{CM} \leq +12V$	(422, 485)		-0.2	-0.035		V
V_{HST}	Hysteresis	$V_{CM} = 0V$	(5)			70		mV
R_{IN}	Input Resistance	$-7V \leq V_{CM} \leq +12V$	DS36C278T		24	68		k Ω
R_{IN}	Input Resistance	$-7V \leq V_{CM} \leq +12V$	DS36C278		48	68		k Ω
I_{IN}	Line Input Current (6)	Other Input = 0V,	DS36C278	$V_{IN} = +12V$	0	0.19	0.25	mA
		$DE = V_{IL}$, $RE^* = V_{IL}$,		$V_{IN} = -7V$	0	-0.1	-0.2	mA
		$V_{CC} = 4.75$ to 5.25	DS36C278T	$V_{IN} = +12V$	0	0.19	0.5	mA
		or 0V		$V_{IN} = -7V$	0	-0.1	-0.4	mA
I_{ING}	Line Input Current Glitch (6)	Other Input = 0V,	DS36C278	$V_{IN} = +12V$	0	0.19	0.25	mA
		$DE = V_{IL}$, $RE^* = V_{IL}$,		$V_{IN} = -7V$	0	-0.1	-0.2	mA
		$V_{CC} = +3.0V$ or $0V$,	DS36C278T	$V_{IN} = +12V$	0	0.19	0.5	mA
		$T_A = 25^\circ C$		$V_{IN} = -7V$	0	-0.1	-0.4	mA
I_B	Input Balance Test	$RS = 500\Omega$	(422) (7)				± 400	mV

- (1) Current into device pins is defined as positive. Current out of device pins is defined as negative. All voltages are referenced to ground except V_{OD1} and V_{OD2} .
- (2) All typicals are given for: $V_{CC} = +5.0V$, $T_A = +25^\circ C$.
- (3) Delta $|V_{OD2}|$ and Delta $|V_{OC}|$ are changes in magnitude of V_{OD2} and V_{OC} , respectively, that occur when input changes state.
- (4) Threshold parameter limits specified as an algebraic value rather than by magnitude.
- (5) Hysteresis defined as $V_{HST} = V_{TH} - V_{TL}$.
- (6) I_{IN} includes the receiver input current and driver TRI-STATE leakage current.
- (7) For complete details of test, see RS-485.

Electrical Characteristics ⁽¹⁾ ⁽²⁾ (continued)

Over Supply Voltage and Operating Temperature ranges, unless otherwise specified

Parameter		Test Conditions		Reference	Min	Typ	Max	Units
V _{OH}	High Level Output Voltage	I _{OH} = -4 mA, V _{ID} = +0.2V		RO Figure 12	3.5	4.6		V
V _{OL}	Low Level Output Voltage	I _{OL} = +4 mA, V _{ID} = -0.2V				0.3	0.5	V
I _{OSR}	Short Circuit Current	V _O = GND		RO	7	35	85	mA
I _{OZR}	TRI-STATE Leakage Current	V _O = 0.4V to 2.4V					±1	µA
DEVICE CHARACTERISTICS								
V _{IH}	High Level Input Voltage			DE, RE*, DI	2.0		V _{CC}	V
V _{IL}	Low Level Input Voltage				GND		0.8	V
I _{IH}	High Level Input Current	V _{IH} = V _{CC}					2	µA
I _{IL}	Low Level Input Current	V _{CC} = 5V	V _{IL} = 0V				-2	µA
		V _{CC} = +3.0V				-2	µA	
I _{CC}	Power Supply Current	Driver and Receiver ON		V _{CC}		200	500	µA
I _{CCR}	(No Load)	Driver OFF, Receiver ON				200	500	µA
I _{CCD}		Driver ON, Receiver OFF				200	500	µA
I _{CCZ}		Driver and Receiver OFF				200	500	µA

Switching Characteristics ⁽¹⁾ ⁽²⁾

Over Supply Voltage and Operating Temperature ranges, unless otherwise specified

Parameter		Test Conditions		Reference	Min	Typ	Max	Units
DRIVER CHARACTERISTICS								
t _{PHLD}	Differential Propagation Delay High to Low	R _L = 54Ω, C _L = 100 pF		Figure 7	10	39	80	ns
t _{PLHD}	Differential Propagation Delay Low to High				10	40	80	ns
t _{SKD}	Differential Skew t _{PHLD} - t _{PLHD}				0	1	10	ns
t _r	Rise Time				3	25	50	ns
t _f	Fall Time				3	25	50	ns
t _{PHZ}	Disable Time High to Z	C _L = 15 pF		Figure 8, Figure 9	—	80	200	ns
t _{PLZ}	Disable Time Low to Z	RE * = L		Figure 10, Figure 11	—	80	200	ns
t _{PZH}	Enable Time Z to High	C _L = 100 pF		Figure 8, Figure 9	—	50	200	ns
t _{PZL}	Enable Time Z to Low	RE * = L		Figure 10, Figure 11	—	65	200	ns
RECEIVER CHARACTERISTICS								
t _{PHL}	Propagation Delay High to Low	C _L = 15 pF		Figure 13, Figure 14	30	210	400	ns
t _{PLH}	Propagation Delay Low to High				30	190	400	ns
t _{SK}	Skew, t _{PHL} - t _{PLH}				0	20	50	ns
t _{PLZ}	Output Disable Time	C _L = 15 pF		Figure 15, Figure 16, Figure 17	—	50	150	ns
t _{PHZ}					—	55	150	ns
t _{PZL}	Output Enable Time				—	40	150	ns
t _{PZH}					—	45	150	ns

(1) All typicals are given for: V_{CC} = +5.0V, T_A = +25°C.

(2) C_L includes probe and jig capacitance.

PARAMETER MEASUREMENT INFORMATION

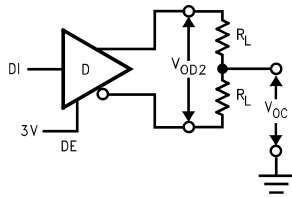

Figure 2. Driver V_{OD2} and V_{OC}

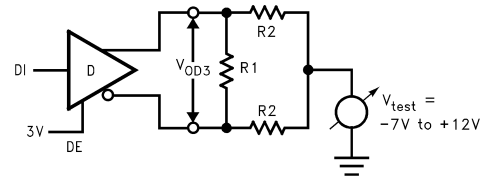
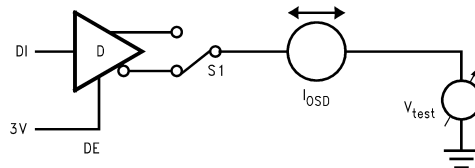

Figure 3. Driver V_{OD3}



Figure 4. Driver V_{OH} and V_{OL}



$V_{test} = -7V$ to $+12V$

Figure 5. Driver I_{0SD}

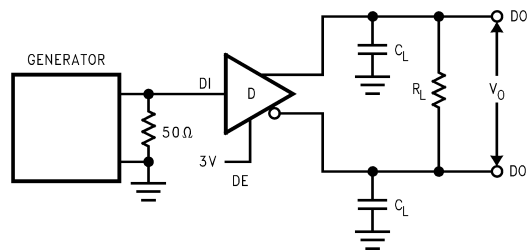

Figure 6. Driver Differential Propagation Delay Test Circuit

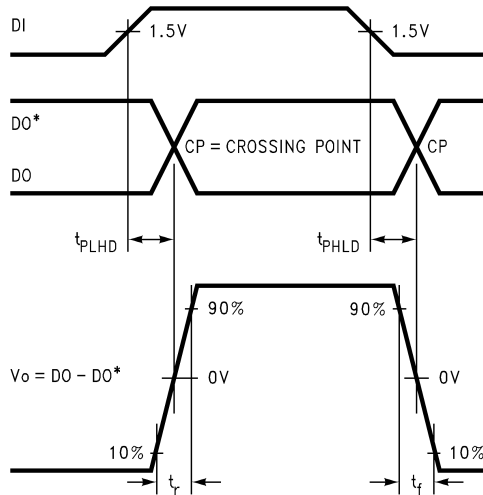

Figure 7. Driver Differential Propagation Delays and Differential Rise and Fall Times

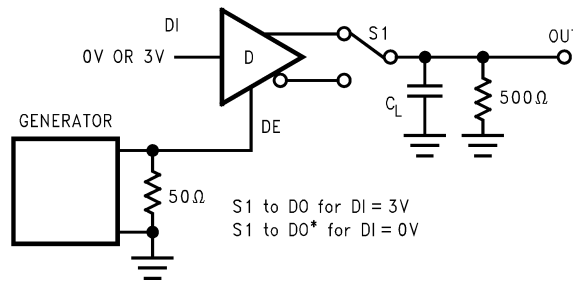

Figure 8. TRI-STATE Test Circuit (t_{PZH} , t_{PHZ})

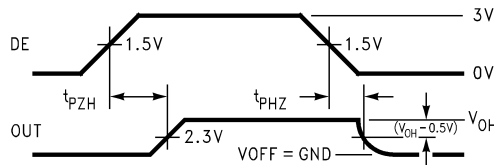

Figure 9. TRI-STATE Waveforms (t_{PZH} , t_{PHZ})

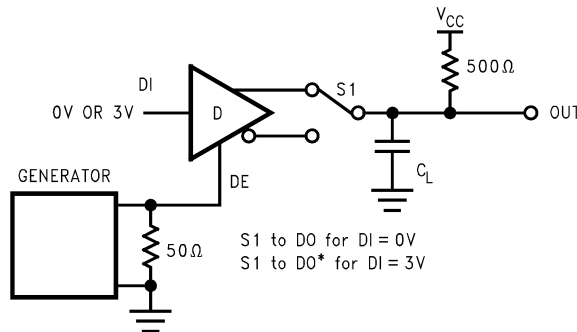

Figure 10. TRI-STATE Test Circuit (t_{PZL} , t_{PLZ})

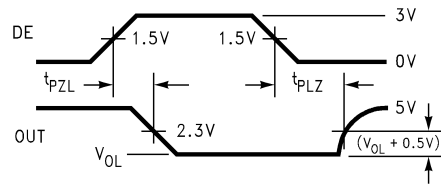

Figure 11. TRI-STATE Waveforms (t_{PZL} , t_{PLZ})

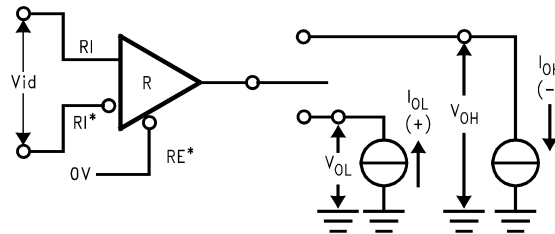

Figure 12. Receiver V_{OH} and V_{OL}

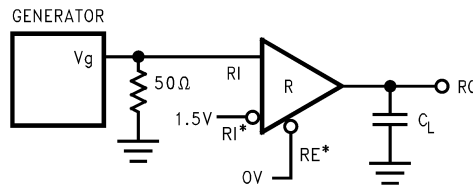

Figure 13. Receiver Differential Propagation Delay Test Circuit

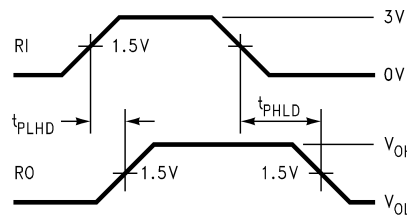

Figure 14. Receiver Differential Propagation Delay Waveforms

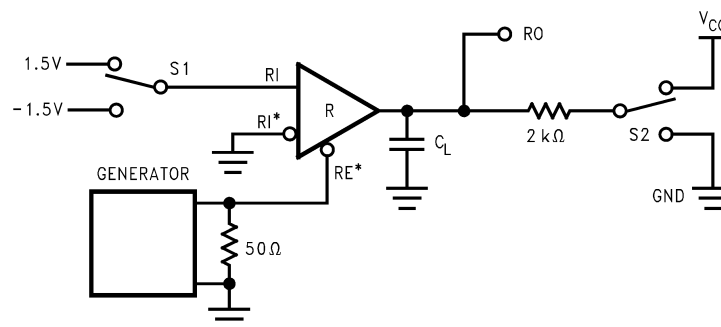

Figure 15. Receiver TRI-STATE Test Circuit

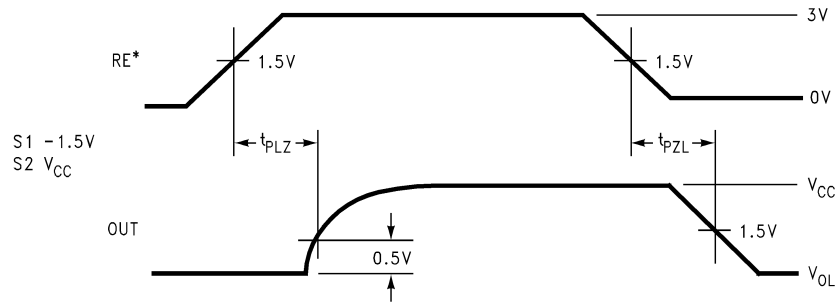

Figure 16. Receiver Enable and Disable Waveforms (t_{PLZ} , t_{PZL})

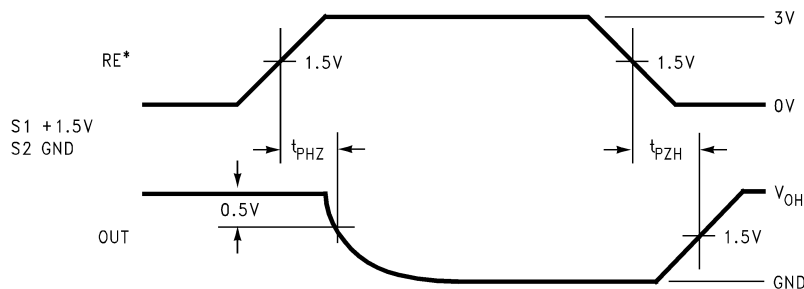

Figure 17. Receiver Enable and Disable Waveforms (t_{PHZ} , t_{PZH})

Typical Application Information

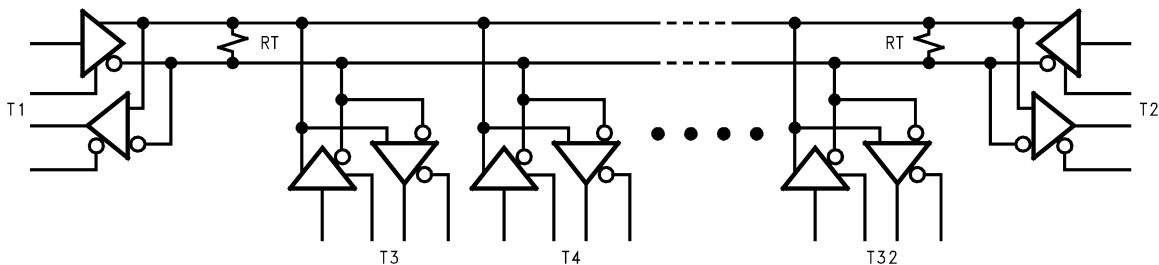

Figure 18. Typical RS-485 Bus Interface

Unit Load

A unit load for an RS-485 receiver is defined by the input current versus the input voltage curve. The gray shaded region is the defined operating range from -7V to $+12\text{V}$. The top border extending from -3V at 0 mA to $+12\text{V}$ at $+1\text{ mA}$ is defined as one unit load. Likewise, the bottom border extending from $+5\text{V}$ at 0 mA to -7V at -0.8 mA is also defined as one unit load (see Figure 19). An RS-485 driver is capable of driving up to 32 unit loads. This allows up to 32 nodes on a single bus. Although sufficient for many applications, it is sometimes desirable to have even more nodes. For example, an aircraft that has 32 rows with 4 seats per row would benefit from having 128 nodes on one bus. This would allow signals to be transferred to and from each individual seat to 1 main station. Usually there is one or two less seats in the last row of the aircraft near the restrooms and food storage area. This frees the node for the main station.

The DS36C278, the DS36C279, and the DS36C280 all have $\frac{1}{2}$ unit load and $\frac{1}{4}$ unit load (UL) options available. These devices will allow up to 64 nodes or 128 nodes guaranteed over temperature depending upon which option is selected. The $\frac{1}{2}$ UL option is available in industrial temperature and the $\frac{1}{4}$ UL is available in commercial temperature.

First, for a ½ UL device the top and bottom borders shown in Figure 19 are scaled. Both 0 mA reference points at +5V and -3V stay the same. The other reference points are +12V at +0.5 mA for the top border and -7V at -0.4 mA for the bottom border (see Figure 19). Second, for a ¼ UL device the top and bottom borders shown in Figure 19 are scaled also. Again, both 0 mA reference points at +5V and -3V stay the same. The other reference points are +12V at +0.25 mA for the top border and -7V at -0.2 mA for the bottom border (see Figure 19).

The advantage of the ½ UL and ¼ UL devices is the increased number of nodes on one bus. In a single master multi-slave type of application where the number of slaves exceeds 32, the DS36C278/279/280 may save in the cost of extra devices like repeaters, extra media like cable, and/or extra components like resistors.

The DS36C279 and DS36C280 have an additional feature which offers more advantages. The DS36C279 has an automatic sleep mode function for power conscious applications. The DS36C280 has a slew rate control for EMI conscious applications. Refer to the sleep mode and slew rate control portion of the application information section in the corresponding datasheet for more information on these features.

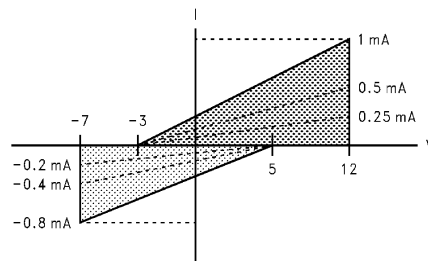

Figure 19. Input Current vs Input Voltage Operating Range

REVISION HISTORY

Changes from Revision B (April 2013) to Revision C	Page
• Changed layout of National Data Sheet to TI format	9

PACKAGING INFORMATION

Orderable Device	Status (1)	Package Type	Package Drawing	Pins	Package Qty	Eco Plan (2)	Lead/Ball Finish (6)	MSL Peak Temp (3)	Op Temp (°C)	Device Marking (4/5)	Samples
DS36C278M/NOPB	LIFEBUY	SOIC	D	8	95	Green (RoHS & no Sb/Br)	CU SN	Level-1-260C-UNLIM	0 to 70	DS36C278M	
DS36C278MX/NOPB	LIFEBUY	SOIC	D	8	2500	Green (RoHS & no Sb/Br)	CU SN	Level-1-260C-UNLIM	0 to 70	DS36C278M	
DS36C278TM	LIFEBUY	SOIC	D	8	95	TBD	Call TI	Call TI	0 to 70	36C278TM	
DS36C278TM/NOPB	LIFEBUY	SOIC	D	8	95	Green (RoHS & no Sb/Br)	CU SN	Level-1-260C-UNLIM	0 to 70	36C278TM	
DS36C278TMX	LIFEBUY	SOIC	D	8	2500	TBD	Call TI	Call TI	0 to 70	36C278TM	
DS36C278TMX/NOPB	NRND	SOIC	D	8	2500	Green (RoHS & no Sb/Br)	CU SN	Level-1-260C-UNLIM	0 to 70	36C278TM	

(1) The marketing status values are defined as follows:

ACTIVE: Product device recommended for new designs.

LIFEBUY: TI has announced that the device will be discontinued, and a lifetime-buy period is in effect.

NRND: Not recommended for new designs. Device is in production to support existing customers, but TI does not recommend using this part in a new design.

PREVIEW: Device has been announced but is not in production. Samples may or may not be available.

OBSELETE: TI has discontinued the production of the device.

(2) **RoHS:** TI defines "RoHS" to mean semiconductor products that are compliant with the current EU RoHS requirements for all 10 RoHS substances, including the requirement that RoHS substance do not exceed 0.1% by weight in homogeneous materials. Where designed to be soldered at high temperatures, "RoHS" products are suitable for use in specified lead-free processes. TI may reference these types of products as "Pb-Free".

RoHS Exempt: TI defines "RoHS Exempt" to mean products that contain lead but are compliant with EU RoHS pursuant to a specific EU RoHS exemption.

Green: TI defines "Green" to mean the content of Chlorine (Cl) and Bromine (Br) based flame retardants meet JS709B low halogen requirements of <=1000ppm threshold. Antimony trioxide based flame retardants must also meet the <=1000ppm threshold requirement.

(3) MSL, Peak Temp. - The Moisture Sensitivity Level rating according to the JEDEC industry standard classifications, and peak solder temperature.

(4) There may be additional marking, which relates to the logo, the lot trace code information, or the environmental category on the device.

(5) Multiple Device Markings will be inside parentheses. Only one Device Marking contained in parentheses and separated by a "~" will appear on a device. If a line is indented then it is a continuation of the previous line and the two combined represent the entire Device Marking for that device.

⁽⁶⁾ Lead/Ball Finish - Orderable Devices may have multiple material finish options. Finish options are separated by a vertical ruled line. Lead/Ball Finish values may wrap to two lines if the finish value exceeds the maximum column width.



Important Information and Disclaimer:The information provided on this page represents TI's knowledge and belief as of the date that it is provided. TI bases its knowledge and belief on information provided by third parties, and makes no representation or warranty as to the accuracy of such information. Efforts are underway to better integrate information from third parties. TI has taken and continues to take reasonable steps to provide representative and accurate information but may not have conducted destructive testing or chemical analysis on incoming materials and chemicals. TI and TI suppliers consider certain information to be proprietary, and thus CAS numbers and other limited information may not be available for release.

In no event shall TI's liability arising out of such information exceed the total purchase price of the TI part(s) at issue in this document sold by TI to Customer on an annual basis.

D (R-PDSO-G8)

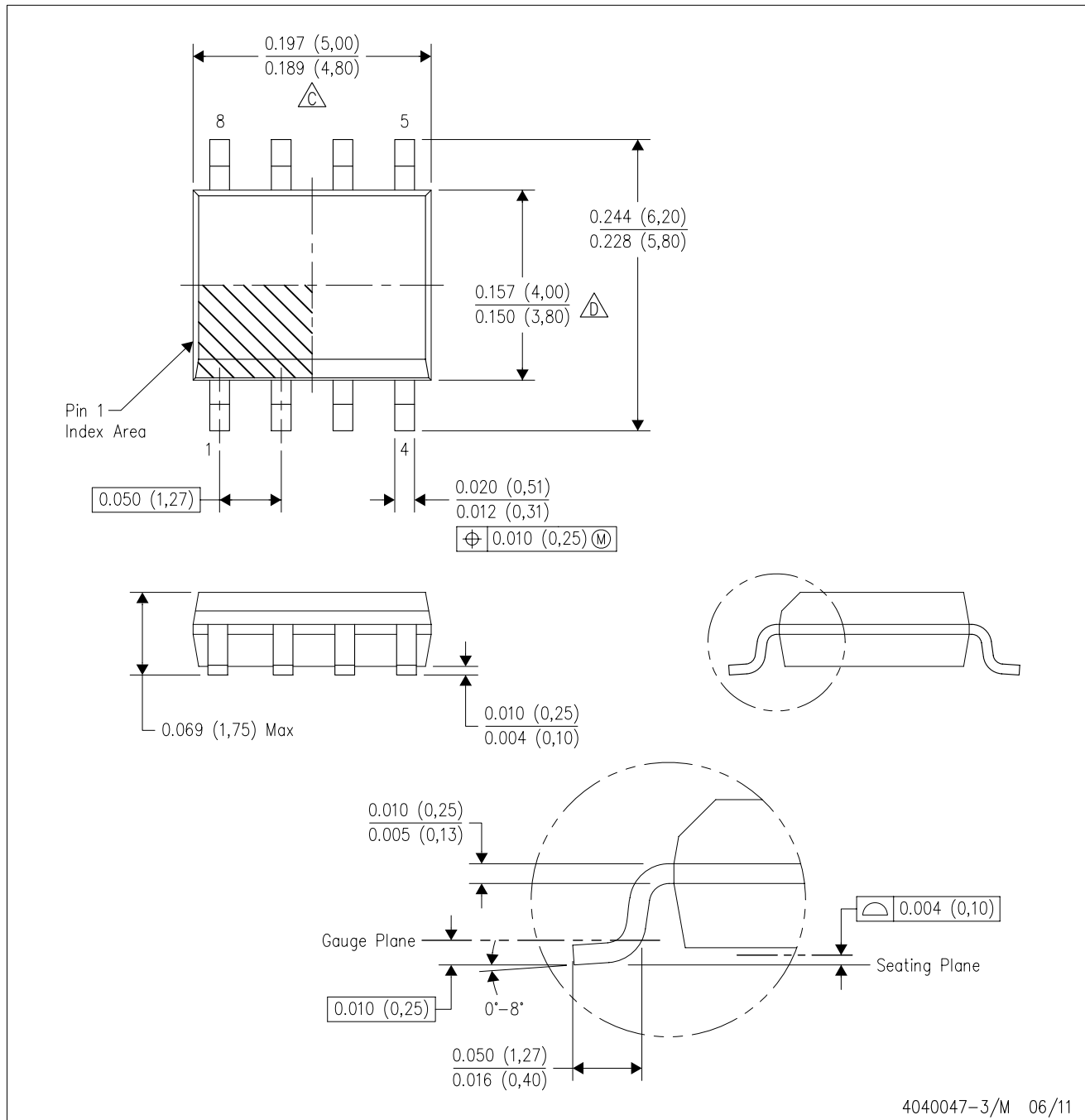
PLASTIC SMALL OUTLINE



- NOTES:
- A. All linear dimensions are in inches (millimeters).
 - B. This drawing is subject to change without notice.
 -  Body length does not include mold flash, protrusions, or gate burrs. Mold flash, protrusions, or gate burrs shall not exceed 0.006 (0,15) each side.
 -  Body width does not include interlead flash. Interlead flash shall not exceed 0.017 (0,43) each side.
 - E. Reference JEDEC MS-012 variation AA.

IMPORTANT NOTICE

Texas Instruments Incorporated (TI) reserves the right to make corrections, enhancements, improvements and other changes to its semiconductor products and services per JESD46, latest issue, and to discontinue any product or service per JESD48, latest issue. Buyers should obtain the latest relevant information before placing orders and should verify that such information is current and complete.

TI's published terms of sale for semiconductor products (<http://www.ti.com/sc/docs/stdterms.htm>) apply to the sale of packaged integrated circuit products that TI has qualified and released to market. Additional terms may apply to the use or sale of other types of TI products and services.

Reproduction of significant portions of TI information in TI data sheets is permissible only if reproduction is without alteration and is accompanied by all associated warranties, conditions, limitations, and notices. TI is not responsible or liable for such reproduced documentation. Information of third parties may be subject to additional restrictions. Resale of TI products or services with statements different from or beyond the parameters stated by TI for that product or service voids all express and any implied warranties for the associated TI product or service and is an unfair and deceptive business practice. TI is not responsible or liable for any such statements.

Buyers and others who are developing systems that incorporate TI products (collectively, "Designers") understand and agree that Designers remain responsible for using their independent analysis, evaluation and judgment in designing their applications and that Designers have full and exclusive responsibility to assure the safety of Designers' applications and compliance of their applications (and of all TI products used in or for Designers' applications) with all applicable regulations, laws and other applicable requirements. Designer represents that, with respect to their applications, Designer has all the necessary expertise to create and implement safeguards that (1) anticipate dangerous consequences of failures, (2) monitor failures and their consequences, and (3) lessen the likelihood of failures that might cause harm and take appropriate actions. Designer agrees that prior to using or distributing any applications that include TI products, Designer will thoroughly test such applications and the functionality of such TI products as used in such applications.

TI's provision of technical, application or other design advice, quality characterization, reliability data or other services or information, including, but not limited to, reference designs and materials relating to evaluation modules, (collectively, "TI Resources") are intended to assist designers who are developing applications that incorporate TI products; by downloading, accessing or using TI Resources in any way, Designer (individually or, if Designer is acting on behalf of a company, Designer's company) agrees to use any particular TI Resource solely for this purpose and subject to the terms of this Notice.

TI's provision of TI Resources does not expand or otherwise alter TI's applicable published warranties or warranty disclaimers for TI products, and no additional obligations or liabilities arise from TI providing such TI Resources. TI reserves the right to make corrections, enhancements, improvements and other changes to its TI Resources. TI has not conducted any testing other than that specifically described in the published documentation for a particular TI Resource.

Designer is authorized to use, copy and modify any individual TI Resource only in connection with the development of applications that include the TI product(s) identified in such TI Resource. NO OTHER LICENSE, EXPRESS OR IMPLIED, BY ESTOPPEL OR OTHERWISE TO ANY OTHER TI INTELLECTUAL PROPERTY RIGHT, AND NO LICENSE TO ANY TECHNOLOGY OR INTELLECTUAL PROPERTY RIGHT OF TI OR ANY THIRD PARTY IS GRANTED HEREIN, including but not limited to any patent right, copyright, mask work right, or other intellectual property right relating to any combination, machine, or process in which TI products or services are used. Information regarding or referencing third-party products or services does not constitute a license to use such products or services, or a warranty or endorsement thereof. Use of TI Resources may require a license from a third party under the patents or other intellectual property of the third party, or a license from TI under the patents or other intellectual property of TI.

TI RESOURCES ARE PROVIDED "AS IS" AND WITH ALL FAULTS. TI DISCLAIMS ALL OTHER WARRANTIES OR REPRESENTATIONS, EXPRESS OR IMPLIED, REGARDING RESOURCES OR USE THEREOF, INCLUDING BUT NOT LIMITED TO ACCURACY OR COMPLETENESS, TITLE, ANY EPIDEMIC FAILURE WARRANTY AND ANY IMPLIED WARRANTIES OF MERCHANTABILITY, FITNESS FOR A PARTICULAR PURPOSE, AND NON-INFRINGEMENT OF ANY THIRD PARTY INTELLECTUAL PROPERTY RIGHTS. TI SHALL NOT BE LIABLE FOR AND SHALL NOT DEFEND OR INDEMNIFY DESIGNER AGAINST ANY CLAIM, INCLUDING BUT NOT LIMITED TO ANY INFRINGEMENT CLAIM THAT RELATES TO OR IS BASED ON ANY COMBINATION OF PRODUCTS EVEN IF DESCRIBED IN TI RESOURCES OR OTHERWISE. IN NO EVENT SHALL TI BE LIABLE FOR ANY ACTUAL, DIRECT, SPECIAL, COLLATERAL, INDIRECT, PUNITIVE, INCIDENTAL, CONSEQUENTIAL OR EXEMPLARY DAMAGES IN CONNECTION WITH OR ARISING OUT OF TI RESOURCES OR USE THEREOF, AND REGARDLESS OF WHETHER TI HAS BEEN ADVISED OF THE POSSIBILITY OF SUCH DAMAGES.

Unless TI has explicitly designated an individual product as meeting the requirements of a particular industry standard (e.g., ISO/TS 16949 and ISO 26262), TI is not responsible for any failure to meet such industry standard requirements.

Where TI specifically promotes products as facilitating functional safety or as compliant with industry functional safety standards, such products are intended to help enable customers to design and create their own applications that meet applicable functional safety standards and requirements. Using products in an application does not by itself establish any safety features in the application. Designers must ensure compliance with safety-related requirements and standards applicable to their applications. Designer may not use any TI products in life-critical medical equipment unless authorized officers of the parties have executed a special contract specifically governing such use. Life-critical medical equipment is medical equipment where failure of such equipment would cause serious bodily injury or death (e.g., life support, pacemakers, defibrillators, heart pumps, neurostimulators, and implantables). Such equipment includes, without limitation, all medical devices identified by the U.S. Food and Drug Administration as Class III devices and equivalent classifications outside the U.S.

TI may expressly designate certain products as completing a particular qualification (e.g., Q100, Military Grade, or Enhanced Product). Designers agree that it has the necessary expertise to select the product with the appropriate qualification designation for their applications and that proper product selection is at Designers' own risk. Designers are solely responsible for compliance with all legal and regulatory requirements in connection with such selection.

Designer will fully indemnify TI and its representatives against any damages, costs, losses, and/or liabilities arising out of Designer's non-compliance with the terms and provisions of this Notice.

Looking for pricing, stock, or lifecycle information?

Click below to explore more details on WIN SOURCE:

 [View DS36C278M/NOPB on WIN SOURCE](#)

 [Texas Instruments](#) Information

Optimize Your Supply Chain with WIN SOURCE Solutions

-  Global Sourcing Solution
-  Obsolete Management
-  Cost Control Management
-  Shortage Management
-  Alternative Solution
-  Excess Inventory Management