



**THE DATASHEET OF
SPMWHT541MD5WAT0S2**



LM561B – 5630 Middle Power LED



Introduction

Features

- Beam Angle: 120°
- Precondition : JEDEC Level 2a
- Dimension : 5.6 x 3.0 x 0.8 mm
- ESD withstand Voltage : up to ± 5 KV [HBM]

Applications

- INDOOR LIGHTING : Ambient Light, LED tube, Down light, LED bulb and Ceiling Light

Simpex Electronic AG
Binzackerstrasse 33
CH-8622 Wetzikon
Telefon +41-44-931 10 40
Telefax +41-44-931 10 41

www.simpex.ch
contact@simpex.ch
MwSt Nr. 235 049



SAMSUNG ELECTRONICS

95, Samsung2-Ro, Giheung-Gu,
Yongin-City, Gyeonggi-Do 446-711, KOREA

Copyright © 1995-2013 SAMSUNG ELECTRONICS Co.,Ltd. All rights reserved. The information in this document is subject to change without notice. SAMSUNG,  SAMSUNG is a registered trademark of SAMSUNG ELECTRONICS.

Contents

1. Product Code Information	-----	3
2. Characteristics	-----	9
3. Typical Characteristics Graph	-----	10
4. Outline Drawing & Dimension	-----	16
5. Reliability Test Items & Conditions	-----	17
6. Solder Conditions	-----	18
7. Tape & Reel	-----	19
8. Label Structure	-----	20
9. Packing Structure	-----	21
10. Precaution For Use	-----	23
11. Hazard Substance Analysis Report	-----	26
Revision History	-----	46

1. Product Code Information

1) Luminous Flux Bins ($T_s = 25^\circ\text{C}$)

Nominal CCT	Product Code	Flux Rank	Sorting Condition $I_m @65\text{mA}$
			Flux Range (Φ_v, I_m)
2700K	SPMWHT541MD5WAW0S1	S1	24.0 ~ 26.0
	SPMWHT541MD5WAW0S2	S2	26.0 ~ 28.0
	SPMWHT541MD5WAW0S3	S3	28.0 ~ 30.0
3000K	SPMWHT541MD5WAV0S1	S1	24.5 ~ 26.5
	SPMWHT541MD5WAV0S2	S2	26.5 ~ 28.5
	SPMWHT541MD5WAV0S3	S3	28.5 ~ 30.5
3500K	SPMWHT541MD5WAU0S1	S1	25.0 ~ 27.0
	SPMWHT541MD5WAU0S2	S2	27.0 ~ 29.0
	SPMWHT541MD5WAU0S3	S3	29.0 ~ 31.0
4000K	SPMWHT541MD5WAT0S1	S1	26.0 ~ 28.0
	SPMWHT541MD5WAT0S2	S2	28.0 ~ 30.0
	SPMWHT541MD5WAT0S3	S3	30.0 ~ 32.0
5000K	SPMWHT541MD5WAR0S1	S1	27.0 ~ 29.0
	SPMWHT541MD5WAR0S2	S2	29.0 ~ 31.0
	SPMWHT541MD5WAR0S3	S3	31.0 ~ 33.0
5700K	SPMWHT541MD5WAQ0S1	S1	26.5 ~ 28.5
	SPMWHT541MD5WAQ0S2	S2	28.5 ~ 30.5
	SPMWHT541MD5WAQ0S3	S3	30.5 ~ 32.5
6500K	SPMWHT541MD5WAP0S1	S1	26.0 ~ 28.0
	SPMWHT541MD5WAP0S2	S2	28.0 ~ 30.0
	SPMWHT541MD5WAP0S3	S3	30.0 ~ 32.0

Notes: SAMSUNG ELECTRONICS maintains a tolerance of $\pm 5\%$ on Luminous Flux measurements

2) Color Bins ($T_s = 25^\circ\text{C}$)

1) Color Binning

Nominal CCT	Product Code	Color Rank	Chromaticity Bins
2700K	SPMWHT541MD5WAW0S1 SPMWHT541MD5WAW0S2 SPMWHT541MD5WAW0S3	W0(Whole bin)	W1, W2, W3, W4, W5, W6, W7, W8, W9, WA, WB, WC, WD, WE, WF, WG
3000K	SPMWHT541MD5WAV0S1 SPMWHT541MD5WAV0S2 SPMWHT541MD5WAV0S3	V0(Whole bin)	V1, V2, V3, V4, V5, V6, V7, V8, V9, VA, VB, VC, VD, VE, VF, VG
3500K	SPMWHT541MD5WAU0S1 SPMWHT541MD5WAU0S2 SPMWHT541MD5WAU0S3	U0(Whole bin)	U1, U2, U3, U4, U5, U6, U7, U8, U9, UA, UB, UC, UD, UE, UF, UG
4000K	SPMWHT541MD5WAT0S1 SPMWHT541MD5WAT0S2 SPMWHT541MD5WAT0S3	T0(Whole bin)	T1, T2, T3, T4, T5, T6, T7, T8, T9, TA, TB, TC, TD, TE, TF, TG
5000K	SPMWHT541MD5WAR0S1 SPMWHT541MD5WAR0S2 SPMWHT541MD5WAR0S3	R0(Whole bin)	R1, R2, R3, R4, R5 R6, R7, R8, R9 ,RA
5700K	SPMWHT541MD5WAQ0S1 SPMWHT541MD5WAQ0S2 SPMWHT541MD5WAQ0S3	Q0(Whole bin)	Q1, Q2, Q3, Q4, Q5 Q6, Q7, Q8, Q9, QA
6500K	SPMWHT541MD5WAP0S1 SPMWHT541MD5WAP0S2 SPMWHT541MD5WAP0S3	P0(Whole bin)	P1, P2, P3, P4, P5 P6, P7, P8, P9, PA

2) Chromaticity Region & Coordinates

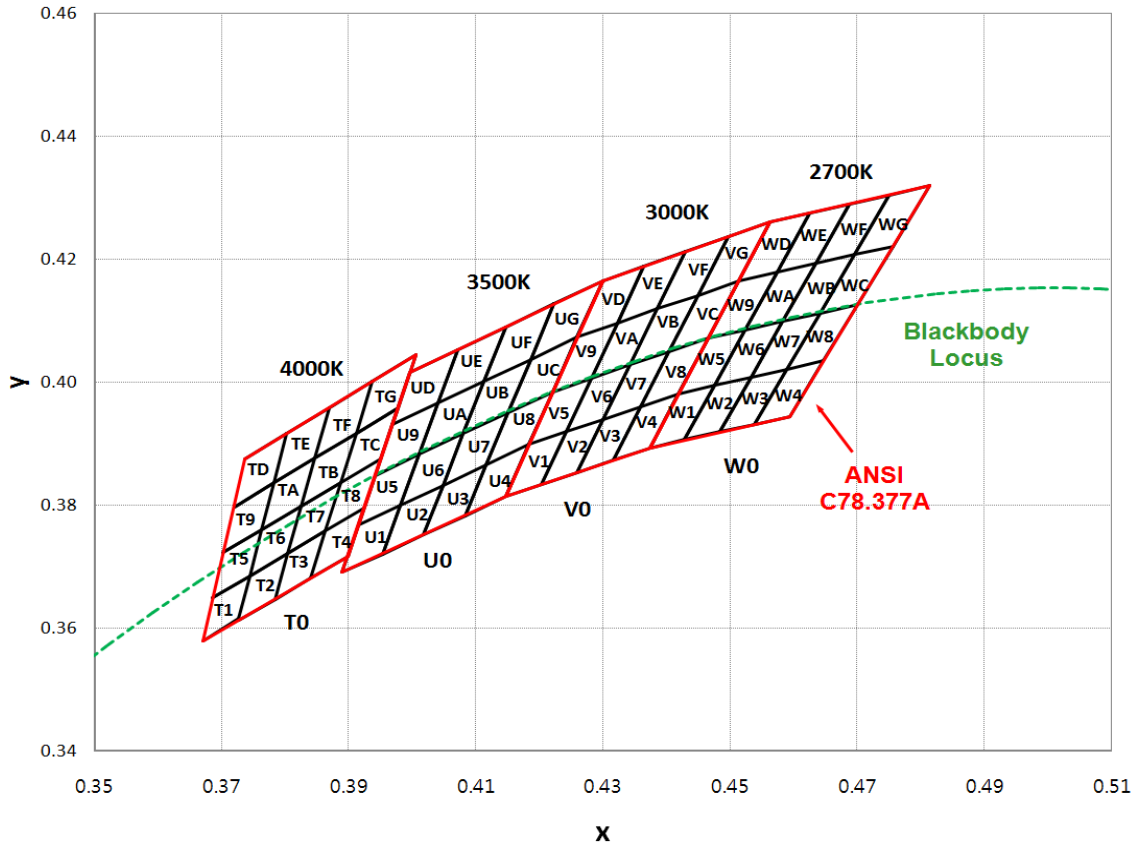



2) Chromaticity Region & Coordinates (Continued)

Region	CIE X	CIE Y	Region	CIE X	CIE Y
W rank (2700K)					
W1	0.4373	0.3893	W9	0.4465	0.4071
	0.4418	0.3981		0.4513	0.4164
	0.4475	0.3994		0.4573	0.4178
	0.4428	0.3906		0.4523	0.4085
W2	0.4428	0.3906	WA	0.4523	0.4085
	0.4475	0.3994		0.4573	0.4178
	0.4532	0.4008		0.4634	0.4193
	0.4483	0.3919		0.4582	0.4099
W3	0.4483	0.3919	WB	0.4582	0.4099
	0.4532	0.4008		0.4634	0.4193
	0.4589	0.4021		0.4695	0.4207
	0.4538	0.3931		0.4641	0.4112
W4	0.4538	0.3931	WC	0.4641	0.4112
	0.4589	0.4021		0.4695	0.4207
	0.4646	0.4034		0.4756	0.4221
	0.4593	0.3944		0.4700	0.4126
W5	0.4418	0.3981	WD	0.4513	0.4164
	0.4465	0.4071		0.4562	0.4260
	0.4523	0.4085		0.4624	0.4274
	0.4475	0.3994		0.4573	0.4178
W6	0.4475	0.3994	WE	0.4573	0.4178
	0.4523	0.4085		0.4624	0.4274
	0.4582	0.4099		0.4687	0.4289
	0.4532	0.4008		0.4634	0.4193
W7	0.4532	0.4008	WF	0.4634	0.4193
	0.4582	0.4099		0.4687	0.4289
	0.4641	0.4112		0.4750	0.4304
	0.4589	0.4021		0.4695	0.4207
W8	0.4589	0.4021	WG	0.4695	0.4207
	0.4641	0.4112		0.4750	0.4304
	0.4700	0.4126		0.4813	0.4319
	0.4646	0.4034		0.4756	0.4221

Region	CIE X	CIE Y	Region	CIE X	CIE Y
V rank (3000K)					
V1	0.4147	0.3814	V9	0.4221	0.3984
	0.4183	0.3898		0.4259	0.4073
	0.4242	0.3919		0.4322	0.4096
	0.4203	0.3833		0.4281	0.4006
V2	0.4203	0.3833	VA	0.4281	0.4006
	0.4242	0.3919		0.4322	0.4096
	0.4300	0.3939		0.4385	0.4119
	0.4259	0.3853		0.4342	0.4028
V3	0.4259	0.3853	VB	0.4342	0.4028
	0.4300	0.3939		0.4385	0.4119
	0.4359	0.3960		0.4449	0.4141
	0.4316	0.3873		0.4403	0.4049
V4	0.4316	0.3873	VC	0.4403	0.4049
	0.4359	0.3960		0.4449	0.4141
	0.4418	0.3981		0.4513	0.4164
	0.4373	0.3893		0.4465	0.4071
V5	0.4183	0.3898	VD	0.4259	0.4073
	0.4221	0.3984		0.4299	0.4165
	0.4281	0.4006		0.4364	0.4188
	0.4242	0.3919		0.4322	0.4096
V6	0.4242	0.3919	VE	0.4322	0.4096
	0.4281	0.4006		0.4364	0.4188
	0.4342	0.4028		0.4430	0.4212
	0.4300	0.3939		0.4385	0.4119
V7	0.4300	0.3939	VF	0.4385	0.4119
	0.4342	0.4028		0.4430	0.4212
	0.4403	0.4049		0.4496	0.4236
	0.4359	0.3960		0.4449	0.4141
V8	0.4359	0.3960	VG	0.4449	0.4141
	0.4403	0.4049		0.4496	0.4236
	0.4465	0.4071		0.4562	0.4260
	0.4418	0.3981		0.4513	0.4164

2) Chromaticity Region & Coordinates (Continued)

Region	CIE X	CIE Y	Region	CIE X	CIE Y
U rank (3500K)					
U1	0.3889	0.3690	U9	0.3941	0.3848
	0.3915	0.3768		0.3968	0.3930
	0.3981	0.3800		0.4040	0.3966
	0.3953	0.3720		0.4010	0.3882
U2	0.3953	0.3720	UA	0.4010	0.3882
	0.3981	0.3800		0.4040	0.3966
	0.4048	0.3832		0.4113	0.4001
	0.4017	0.3751		0.4080	0.3916
U3	0.4017	0.3751	UB	0.4080	0.3916
	0.4048	0.3832		0.4113	0.4001
	0.4116	0.3865		0.4186	0.4037
	0.4082	0.3782		0.4150	0.3950
U4	0.4082	0.3782	UC	0.4150	0.3950
	0.4116	0.3865		0.4186	0.4037
	0.4183	0.3898		0.4259	0.4073
	0.4147	0.3814		0.4221	0.3984
U5	0.3915	0.3768	UD	0.3968	0.3930
	0.3941	0.3848		0.3996	0.4015
	0.4010	0.3882		0.4071	0.4052
	0.3981	0.3800		0.4040	0.3966
U6	0.3981	0.3800	UE	0.4040	0.3966
	0.4010	0.3882		0.4071	0.4052
	0.4080	0.3916		0.4146	0.4089
	0.4048	0.3832		0.4113	0.4001
U7	0.4048	0.3832	UF	0.4113	0.4001
	0.4080	0.3916		0.4146	0.4089
	0.4150	0.3950		0.4222	0.4127
	0.4116	0.3865		0.4186	0.4037
U8	0.4116	0.3865	UG	0.4186	0.4037
	0.4150	0.3950		0.4222	0.4127
	0.4221	0.3984		0.4299	0.4165
	0.4183	0.3898		0.4259	0.4073

Region	CIE X	CIE Y	Region	CIE X	CIE Y
T rank (4000K)					
T1	0.367	0.3578	T9	0.3702	0.3722
	0.3726	0.3612		0.3763	0.376
	0.3744	0.3685		0.3782	0.3837
	0.3686	0.3649		0.3719	0.3797
T2	0.3726	0.3612	TA	0.3763	0.3760
	0.3783	0.3646		0.3825	0.3798
	0.3804	0.3721		0.3847	0.3877
	0.3744	0.3685		0.3782	0.3837
T3	0.3783	0.3646	TB	0.3825	0.3798
	0.3840	0.3681		0.3887	0.3836
	0.3863	0.3758		0.3912	0.3917
	0.3804	0.3721		0.3847	0.3877
T4	0.384	0.3681	TC	0.3887	0.3837
	0.3898	0.3716		0.395	0.3875
	0.3924	0.3794		0.3978	0.3958
	0.3863	0.3758		0.3912	0.3917
T5	0.3686	0.3649	TD	0.3719	0.3797
	0.3744	0.3685		0.3782	0.3837
	0.3763	0.376		0.3802	0.3916
	0.3702	0.3722		0.3736	0.3874
T6	0.3744	0.3685	TE	0.3782	0.3837
	0.3804	0.3721		0.3847	0.3877
	0.3825	0.3798		0.3869	0.3958
	0.3763	0.376		0.3802	0.3916
T7	0.3804	0.3721	TF	0.3847	0.3877
	0.3863	0.3758		0.3912	0.3917
	0.3887	0.3836		0.3937	0.4001
	0.3825	0.3798		0.3869	0.3958
T8	0.3863	0.3758	TG	0.3912	0.3917
	0.3924	0.3794		0.3978	0.3958
	0.395	0.3875		0.4006	0.4044
	0.3887	0.3836		0.3937	0.4001



2) Chromaticity Region & Coordinates (Continued)

Region	CIE X	CIE Y	Region	CIE X	CIE Y
R rank (5000K)					
R1	0.3366	0.3369	R6	0.3456	0.3601
	0.3441	0.3428		0.3539	0.3669
	0.3449	0.3515		0.3551	0.3760
	0.3369	0.3451		0.3464	0.3688
R2	0.3441	0.3428	R7	0.3363	0.3287
	0.3515	0.3487		0.3433	0.3341
	0.3527	0.3578		0.3441	0.3428
	0.3449	0.3515		0.3366	0.3369
R3	0.3369	0.3451	R8	0.3433	0.3341
	0.3449	0.3515		0.3503	0.3396
	0.3456	0.3601		0.3515	0.3487
	0.3373	0.3534		0.3441	0.3428
R4	0.3449	0.3515	R9	0.3376	0.3616
	0.3527	0.3578		0.3464	0.3688
	0.3539	0.3669		0.3471	0.3775
	0.3456	0.3601		0.3379	0.3698
R5	0.3373	0.3534	RA	0.3464	0.3688
	0.3456	0.3601		0.3551	0.3760
	0.3464	0.3688		0.3564	0.3851
	0.3376	0.3616		0.3471	0.3775
Q rank (5700K)					
Q1	0.3222	0.3243	Q6	0.3292	0.3461
	0.3294	0.3306		0.3373	0.3534
	0.3293	0.3384		0.3376	0.3616
	0.3217	0.3316		0.3292	0.3539
Q2	0.3294	0.3306	Q7	0.3227	0.3170
	0.3366	0.3369		0.3295	0.3228
	0.3369	0.3451		0.3294	0.3306
	0.3293	0.3384		0.3222	0.3243
Q3	0.3217	0.3316	Q8	0.3295	0.3228
	0.3293	0.3384		0.3363	0.3287
	0.3292	0.3461		0.3366	0.3369
	0.3212	0.3389		0.3294	0.3306
Q4	0.3293	0.3384	Q9	0.3207	0.3462
	0.3369	0.3451		0.3292	0.3539
	0.3373	0.3534		0.3291	0.3617
	0.3292	0.3461		0.3202	0.3535
Q5	0.3212	0.3389	QA	0.3292	0.3539
	0.3292	0.3461		0.3376	0.3616
	0.3292	0.3539		0.3379	0.3698
	0.3207	0.3462		0.3291	0.3617

Region	CIE X	CIE Y	Region	CIE X	CIE Y
P rank (6500K)					
P1	0.3068	0.3113	P6	0.3126	0.3324
	0.3145	0.3187		0.3210	0.3408
	0.3135	0.3256		0.3205	0.3481
	0.3055	0.3177		0.3117	0.3393
P2	0.3145	0.3187	P7	0.3081	0.3049
	0.3221	0.3261		0.3154	0.3119
	0.3216	0.3334		0.3145	0.3187
	0.3135	0.3256		0.3068	0.3113
P3	0.3055	0.3177	P8	0.3154	0.3119
	0.3135	0.3256		0.3226	0.3188
	0.3126	0.3324		0.3221	0.3261
	0.3041	0.3240		0.3145	0.3187
P4	0.3135	0.3256	P9	0.3028	0.3304
	0.3216	0.3334		0.3117	0.3393
	0.3210	0.3408		0.3107	0.3461
	0.3126	0.3324		0.3015	0.3368
P5	0.3041	0.3240	PA	0.3117	0.3393
	0.3126	0.3324		0.3205	0.3481
	0.3117	0.3393		0.3200	0.3554
	0.3028	0.3304		0.3107	0.3461

Notes: SAMSUNG ELECTRONICS maintains ± 0.007 tolerance of Cx, Cy

2. Characteristics

1) Absolute Maximum Rating

Item	Symbol	Rating	Condition
Operating temperature range	T_{op}	-40°C ~ +85°C	-
Storage temperature range	T_{stg}	-40°C ~ +120°C	-
LED junction temperature	T_J	110°C	-
Forward Current	I_F	150 mA	-
Peak Pulsed Forward Current	I_{FP}	300 mA	Duty 1/10 pulse width 10ms
Thermal resistance	$R_{th, j-s}$	16°C/W	Junction to solder point
Assembly Process Temperature	-	260°C, < 10sec	-
ESD	-	5kV	HBM

2) Electro-optical Characteristics

Item	Unit	Nominal CCT	Product Code	Rank	Min	Typ	Max		
Forward Voltage ¹⁾ (V_F) (@65 mA, $T_s = 25^\circ\text{C}$)	V	-	-	WA	AZ	2.70	-	2.80	
					A1	2.80	-	2.90	
					A2	2.90	-	3.00	
					A3	3.00	-	3.10	
					A4	3.10	-	3.20	
Luminous Flux ²⁾ (Φ_v) (@65 mA, $T_s = 25^\circ\text{C}$)	lm	2700K (W0)	*WAW0S1	S1	24.0	-	26.0		
			*WAW0S2	S2	26.0	-	28.0		
			*WAW0S3	S3	28.0	-	30.0		
		3000K (V0)	*WAV0S1	S1	24.5	-	26.5		
			*WAV0S2	S2	26.5	-	28.5		
			*WAV0S3	S3	28.5	-	30.5		
		3500K (U0)	*WAU0S1	S1	25.0	-	27.0		
			*WAU0S2	S2	27.0	-	29.0		
			*WAU0S3	S3	29.0	-	31.0		
		4000K (T0)	*WAT0S1	S1	26.0	-	28.0		
			*WAT0S2	S2	28.0	-	30.0		
			*WAT0S3	S3	30.0	-	32.0		
		5000K (R0)	*WAR0S1	S1	27.0	-	29.0		
			*WAR0S2	S2	29.0	-	31.0		
			*WAR0S3	S3	31.0	-	33.0		
		5700K (Q0)	*WAQ0S1	S1	26.5	-	28.5		
			*WAQ0S2	S2	28.5	-	30.5		
			*WAQ0S3	S3	30.5	-	32.5		
		6500K (P0)	*WAP0S1	S1	26.0	-	28.0		
			*WAP0S2	S2	28.0	-	30.0		
			*WAP0S3	S3	30.0	-	32.0		
		Reverse Voltage (@5 mA, $T_s = 25^\circ\text{C}$)	V	-	-	-	0.7	-	1.2
		Color Rendering Index ³⁾ (R_a)	-	-	-	5	80	-	-
		Special CRI ⁴⁾ (R9)	-	-	-	-	0	-	-

Notes:

1)~4) SAMSUNG ELECTRONICS maintains a tolerance of $V_F:\pm 0.1$ V, $\Phi_v:\pm 5$ %, $R_a:\pm 3.0$, $R9:\pm 6.5$ on measurements

5) " * " is Product Code of "SPMWHT541MD5"

3. Typical Characteristics Graph ($T_s = 25^\circ\text{C}$)

1) Spectrum Distribution

[CCT : 2700K & 3000K]



[CCT : 3500K & 4000K]



[CCT : 5000K & 5700K]

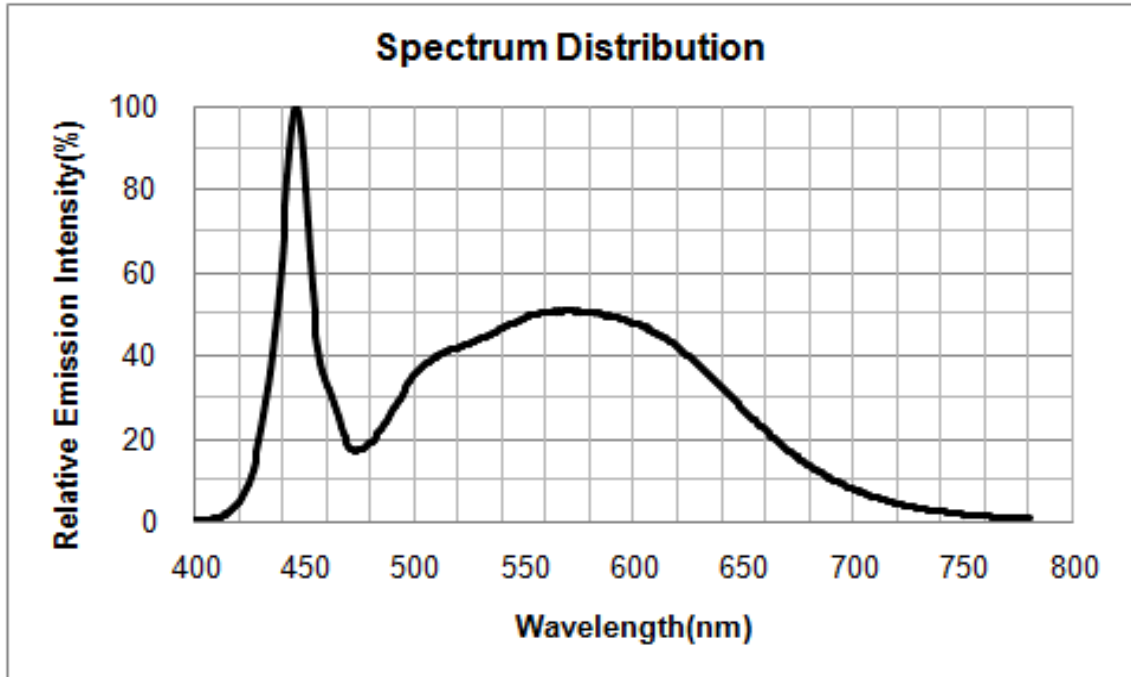

[CCT : 6500K]

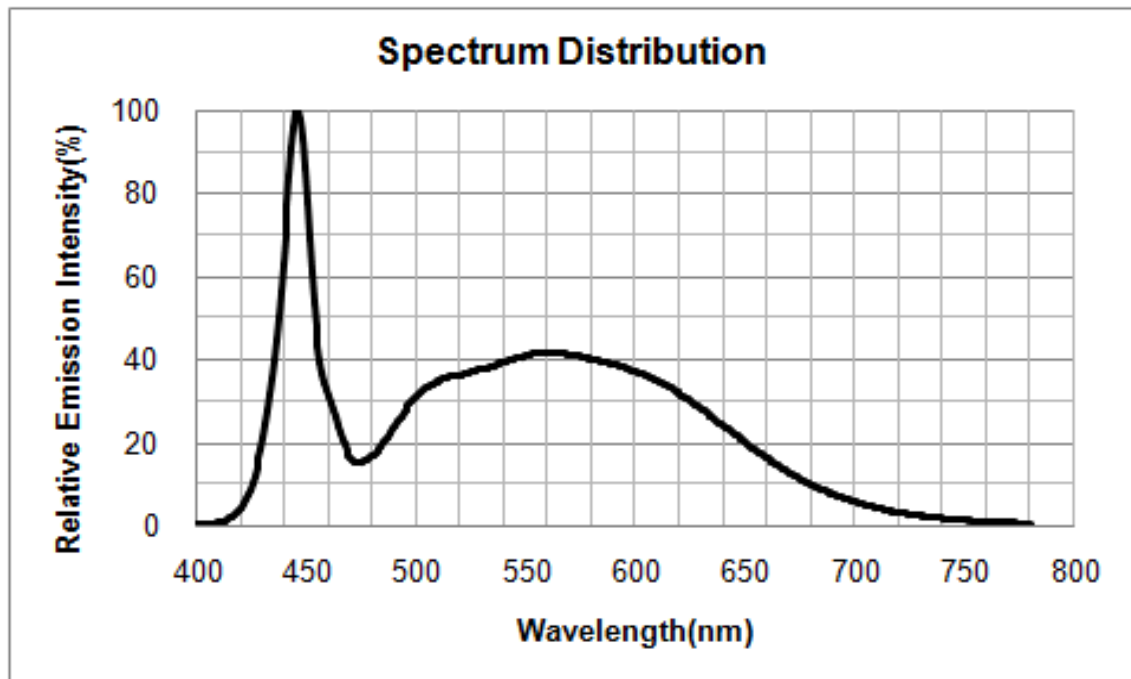

2) Forward Current Characteristics

[Relative Luminous Flux vs. Forward Current]

($T_s = 25^\circ\text{C}$)



[Forward Current vs. Forward Voltage]

($T_s = 25^\circ\text{C}$)

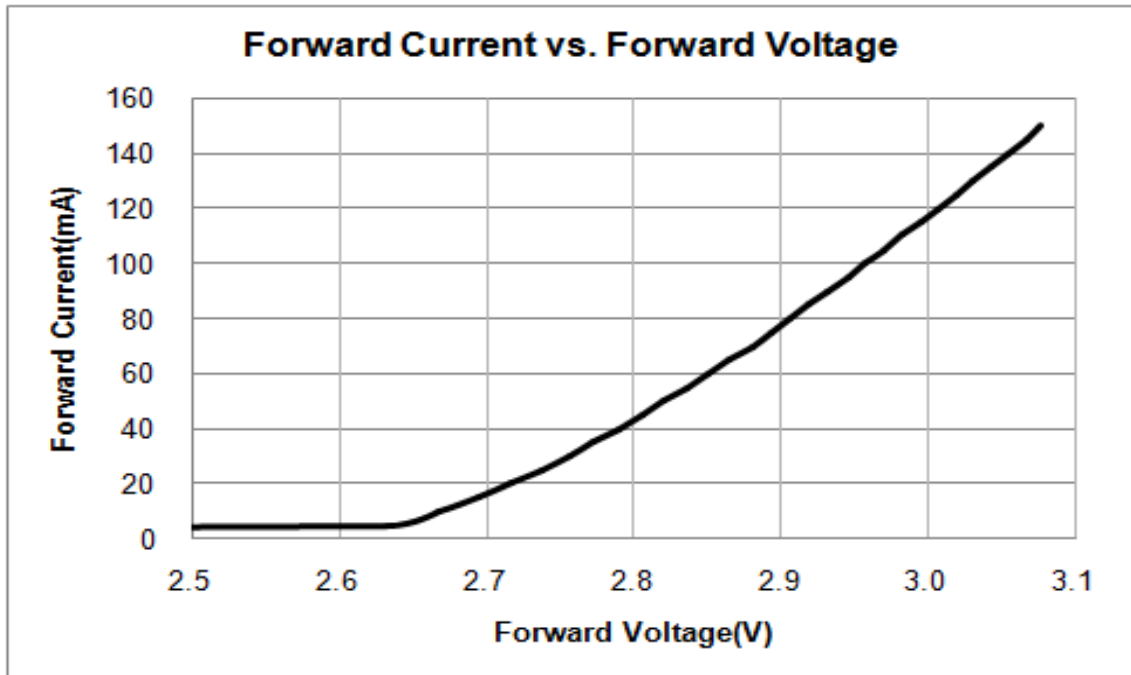

3) Temperature Characteristics

[Relative Luminous Flux vs. T_s]

($I_F = 65\text{mA}$)



[Forward Voltage vs. T_s]

($I_F = 65\text{mA}$)



4) Color shift Characteristics

[Forward Current vs. Color Δx , Δy]

($T_s = 25^\circ\text{C}$)



5) Derating Curve

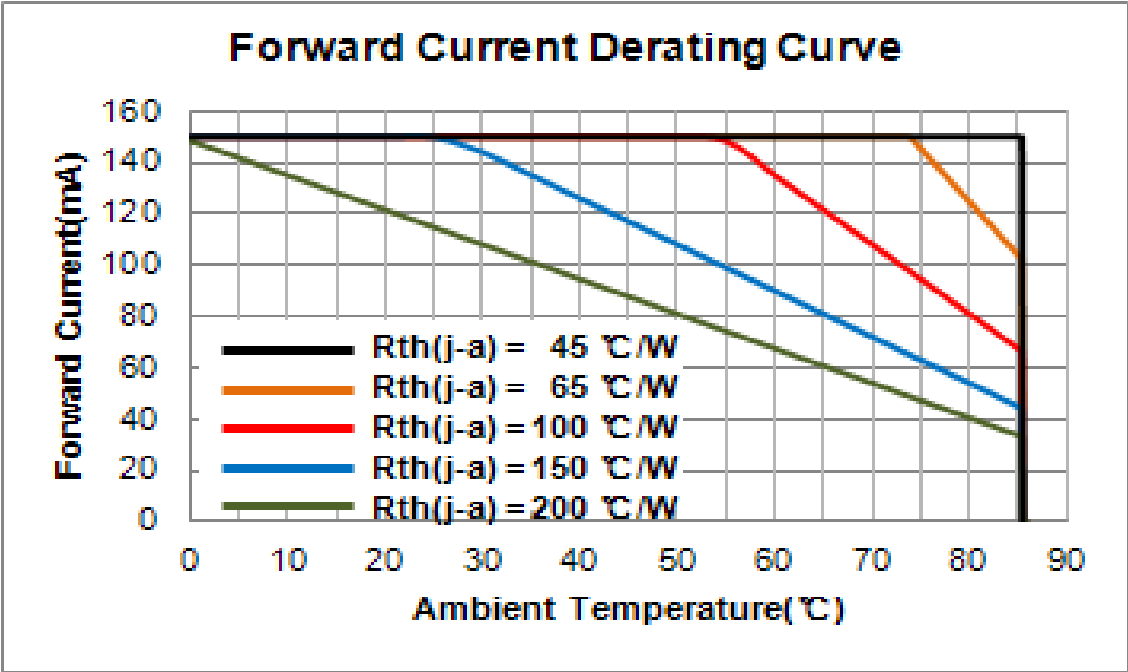

6) Beam Angle Characteristics

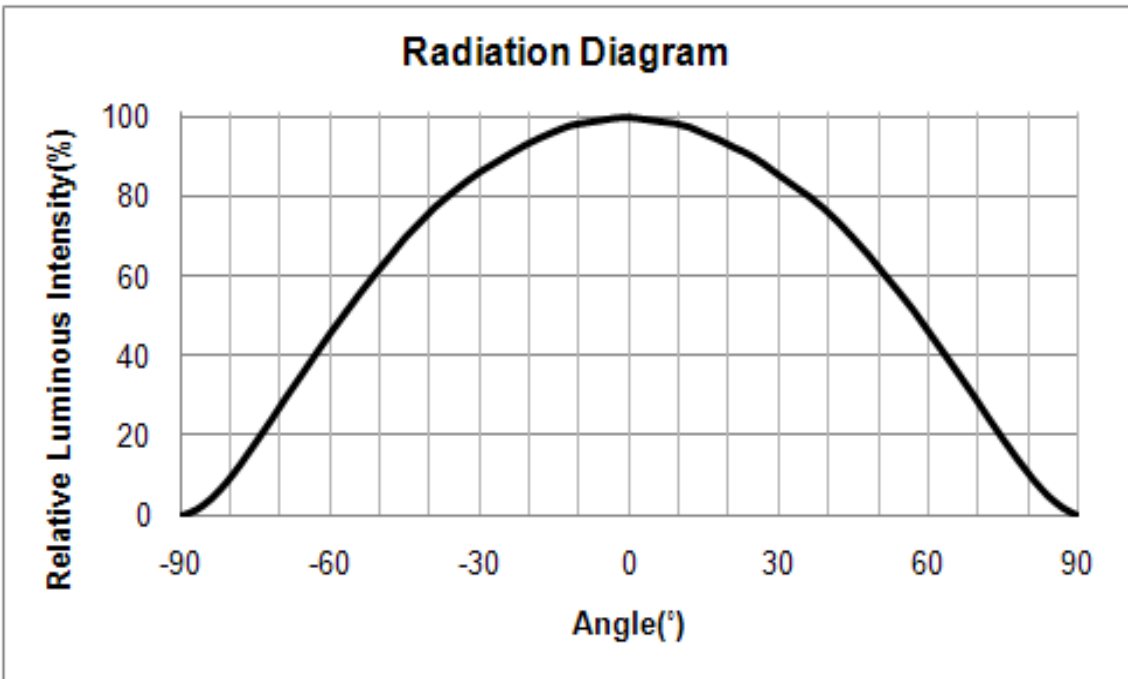

4. Outline Drawing & Dimension

1. Tolerance is ± 0.10 mm
2. The maximum compressing force is 15N on the body (a)
3. Do not place pressure on the encapsulation resin (b)

Left Side View

Top View

Bottom View



Anode

Front View

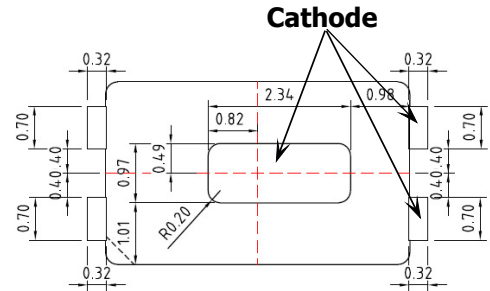

Cathode

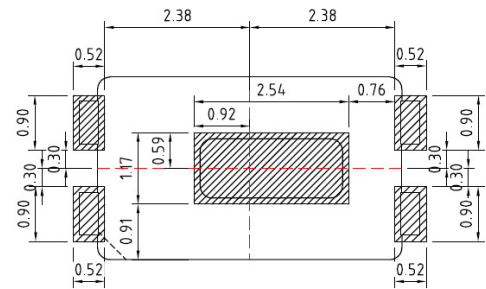

Recommended Land Pattern

Notes:

- 1) This LED has built-in ESD protection device(s) connected in parallel to LED Chip(s).
- 2) Ts point & measurement method
 - ① Measure the nearest point to the thermal pad. If necessary, remove PSR of PCB to reach Ts point.
 - ② Thermal pad must be soldered to the PCB to dissipate heat properly. Otherwise, LED can be damaged.
- 3) Precautions
 - ① The pressure on the LEDs will influence to the reliability of the LEDs. Precautions should be taken to avoid the strong pressure on the LEDs. Do not put stress on the LEDs during heating.
 - ② Re-soldering should not be done after the LEDs have been soldered. If re-soldering is unavoidable, LED's characteristics should be carefully checked before and after such repair.
 - ③ Do not stack assembled PCBs together. Since materials of LEDs is soft, abrasion between two PCB assembled with LED might cause catastrophic failure of the LEDs.

5. Reliability Test Items and Conditions

1) Test Items

Test Item	Test Conditions	Test Hours/Cycles	Sample No	
MSL Test	125 °C 24hrs drying → 60 °C, 60 %RH 120hrs → 260 °C 10sec 3 cycles	1 cycle	11	
Room Temperature life test	25 °C±3 °C, DC150 mA	1,000 hrs	22	
High Temperature life test	85 °C±3 °C, DC150 mA	1,000 hrs	22	
High Temperature humidity life test	85 °C±3 °C, 85 %±2 %RH, DC150 mA	1,000 hrs	22	
Low Temperature life test	-40 °C±3 °C, DC150 mA	1,000 hrs	22	
Powered Temperature Cycle test	-45°C/20 min ↔ 85°C/20 min, Sweep 100min cycle on/off: each 5 min, DC 150mA	100 cycle	22	
Thermal Shock	-45 °C/15 min ↔ 125 °C/15 min → Hot plate 180 °C	500 cycle	100	
High Temperature Storage	Ta=120 °C±3 °C	1000 hrs	11	
Low Temperature Storage	Ta=-40 °C±3 °C	1000 hrs	11	
ESD(HBM)		R1:10 MΩ, R2:1.5 kΩ, C:100 pF, V = ±5 kV	5 times	5
ESD(MM)		R1:10 MΩ, R2: 0, C:200 pF, V = ±0.5 kV	5 times	5
Vibration Test	20~2000~20 Hz 200 m/s ² , Sweep 4 min X, Y, Z 3 direction, each 1 cycle	4 cycles	11	
Mechanical Shock Test	1500G, 0.5 ms, 3 shocks each X-Y-Z axis	5 cycles	11	

2) Criteria for Judging the Damage

Item	Symbol	Test Condition	Limit	
			Min	Max
Forward Voltage	V _F	I _F = 65 mA	Init. Value*0.9	Init. Value*1.1
Luminous Flux	Φ _v	I _F = 65 mA	Init. Value*0.7	Init. Value*1.2

6. Solder Conditions

1) Reflow Conditions (Pb Free)

Reflow Frequency : 2 times max.



2) For Manual Soldering

Not more than 5 seconds @Max. 300°C, under soldering iron.

7. Tape & Reel

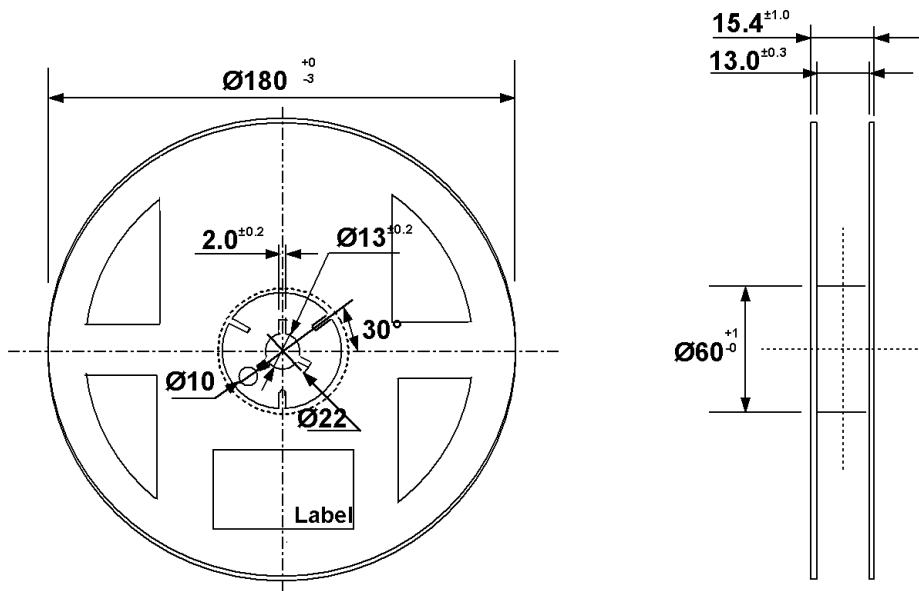

Tolerance ±0.2 , Unit:mm

- (1) Quantity : The quantity/Reel to be Max. 2,000 pcs, .
- (2) Cumulative Tolerance : Cumulative tolerance/10 pitches to be ±0.2 mm
- (3) Adhesion Strength of Cover Tape : Adhesion strength to be 0.1-0.7N when the cover tape is turned off from the carrier tape at 10°C angle to be the carrier tape.
- (4) Packaging : P/N, Manufacturing data code no. and quantity to be indicated on a damp proof Package.



8. Label Structure

1) Label Structure

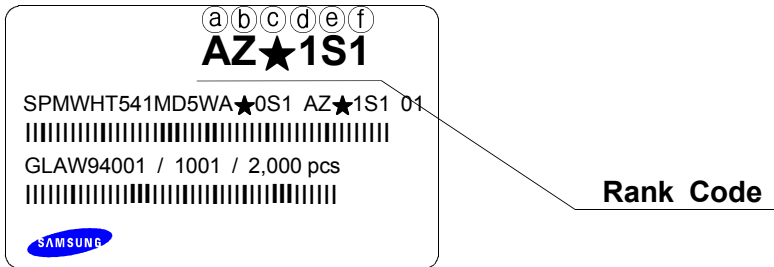

N.B) Denoted rank is the only example.

'★' means All kind of Chromaticity Coordinate Rank.

Rank Code

- ⒶⒷ : Forward Voltage(V_F) Rank (refer to page. 9)
- ⒸⒹ : Chromaticity Coordinate Rank (refer to page. 5~8)
- ⒺⒻ : Luminous Flux(Φ_v , lm) Rank (refer to page. 3)

2) LOT Number

The Lot number is composed of the following characters

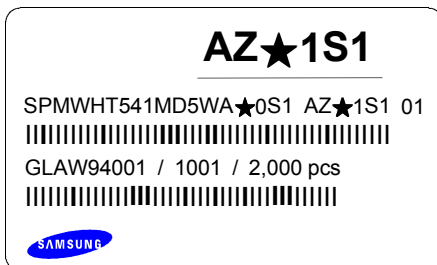

①②③④⑤⑥⑦⑧⑨ / 1ⒶⒷⒸ / 2,000 PCS

- ① : Production Site (S:SAMSUNG ELECTRONICS, G:GOSIN CHINA)
- ② : L (LED)
- ③ : Product State (A:Normality, B:Bulk, C:First Production, R:Reproduction, S:Sample)
- ④ : Year (V:2011, W:2012, X:2013...)
- ⑤ : Month (1 ~ 9, A, B)
- ⑥ : Day (1 ~ 9, A, B ~ V)
- ⑦⑧⑨ : SAMSUNG ELECTRONICS LED Product number (1 ~ 999)
- ⒶⒷⒸ : Reel Number (1 ~ 999)



9. Packing Structure

1) Packing Process

Reel

AZ★1S1

SPMWHT541MD5WA★0S1 AZ★1S1 01

|||||

GLAW94001 / 1001 / 2,000 pcs

|||||



Aluminum Vinyl Bag

AZ★1S1

SPMWHT541MD5WA★0S1 AZ★1S1 01

|||||

GLAW94001 / 1001 / 2,000 pcs

|||||

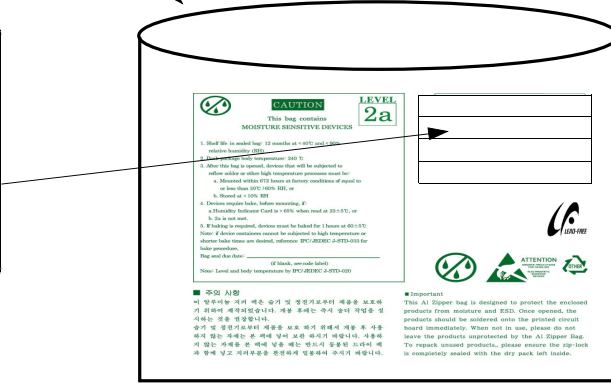

Material : Paper(SW3B(B))

TYPE	SIZE(mm)		
	L	W	H
7inch	245	220	182

① SIDE

AZ★1S1

SPMWHT541MD5WA★0S1 AZ★1S1 01

|||||

GLAW94001 / 1001 / 2,000 pcs

|||||



10. Precaution for use

- 1) For over-current-proof function, customers are recommended to apply resistors to prevent sudden change of the current caused by slight shift of the voltage.

과전류 방지를 위해 전압의 미세한 이동에 의해 야기되는 전류의 순간 변화를 방지하기 위해 저항 등의 설치를 권장함.

- 2) This device should not be used in any type of fluid such as water, oil, organic solvent, etc. When washing is required, IPA is recommended to use.

제품은 물, 오일, 유기물과 같은 액체 타입에서의 사용은 제한되며, 세정이 필요할 시에는 IPA 사용을 권장함.

- 3) When the LEDs illuminate, operating current should be decided after considering the ambient maximum temperature.

LED의 발광 시, 동작 전류는 주변 최고온도를 고려하여 결정되어야 함.

- 4) LEDs must be stored in a clean environment.

If the LEDs are to be stored for 3 months or more after being shipped from Samsung Electronics, they should be packed by a sealed container with nitrogen gas injected. (Shelf life of sealed bags: 12 months, temp. ~40°C, ~90%RH)

LED의 보관은 청정한 환경에서 보존되어야 하며, 만약 삼성전자로부터 공급받는 후 3개월 또는 그 이상 보관이 필요하다면 질소 가스를 동봉한 보존용기에 보관되어야 함. (보존 bag의 수명 : 12 개월, 보존 온도 ~40°C, 습도 ~90%RH)

- 5) After storage bag is open, device subjected to soldering, solder reflow, or other high temperature processes must be:

보존 Bag이 개봉된 후에, 납땀이나 reflow 등의 높은 온도에 노출되는 제품은 다음의 사항에 부합되어야 함.

- a. Mounted within 672 hours(28 days) at an assembly line with a condition of no more than 30°C/60%RH,

- a. 제품은 30°C/60%RH보다 같거나 낮은 조립조건에서 672시간(28일)이내에 조립해야 함.

- b. Stored at <10%RH.

- b. 10% 이하의 상대습도에서 보관되어야 함.

- 6) Repack unused Products with anti-moisture packing, fold to close any opening and then store in a dry place.

사용하지 않은 제품은 방습팩에 넣어 개봉 부위를 달아서 다시 포장한 후, 건조한 장소에서 보관할 것을 권장함.

7) Devices require baking before mounting, if humidity card reading is $>60\%$ at $23\pm 5^{\circ}\text{C}$.
만약 습도표시카드의 수치가 $23\pm 5^{\circ}\text{C}$ 에서 60% 이상이라면, 제품 실장 전 **baking**해야 함.

8) Devices must be baked for 1 hour at $65\pm 5^{\circ}\text{C}$, if baking is required.
만약 **baking**이 필요하다면, 제품은 $65\pm 5^{\circ}\text{C}$ 에서 1시간 정도 **baking** 되어야 함.

9) The LEDs are sensitive to the static electricity and surge. It is recommended to use a wrist band or anti-electrostatic glove when handling the LEDs.
LED는 정전기 및 서지에 민감한 제품이므로, LED 제품을 다룰 시에는 정전기 방지장갑이나 손목밴드를 사용하기를 권장함.

If voltage exceeding the absolute maximum rating is applied to LEDs, it may cause damage or even destruction to LED devices.

만약 절대 허용치를 초과하는 전압이 LED에 가해지면, LED 소자는 파괴되거나 손상될 수 있음.

Damaged LEDs may show some unusual characteristics such as increase in leak current, lowered turn-on voltage, or abnormal lighting of LEDs at low current.

손상된 제품은 누설전류의 증가, Turn on 전압의 저하, 저 전류에서의 점등불량 등의 이상 거동을 보일 수 있음.

10) VOCs (volatile organic compounds) may be occurred by adhesives, flux, hardener or organic additives which is used in luminaires (fixture) and LED silicone bags are permeable to it. It may lead a discoloration when LED expose to heat or light.

VOCs(휘발성 유기 화합물)는 등기구에 사용되는 접착제, Flux, 경화제, 유기물 첨가제에서 발생하여 LED 실리콘 봉지체를 투과하고, 빛 또는 열에 노출되었을 때 변색이 발생 할 수 있음.

This phenomenon can give a significant loss of light emitted(output) from the luminaires(fixture).

이러한 현상은 등기구로부터 나오는 빛의 중대한 손실을 줄 수 있음.

In order to prevent these problems, we recommend you to know the physical properties for the materials used in luminaires, It requires to select carefully.

이러한 문제 발생 방지를 위해서, 등기구에 사용되는 자재에 대한 물성을 알고 주의하여 선택 되어야함.

11) Risk of Sulfurization (or Tarnishing)

The lead frame from Samsung Electronics is a plated package and it may change to black(or dark colored) when it is exposed to Ag (a), Sulfur (S), Cchlorine (Cl) or other halogen compound. It requires attention.

삼성전자의 리드 프레임은 Ag(은)을 도금한 Package 제품으로 황(S), 염소(Cl), 또는 다른 할로겐 화합물들에 노출시 Ag(은)은 검정(또는 어두운색)으로 바뀔 수 있으니 주의가 필요함.

Sulfide (Sulfurization) of the lead frame may cause a change of degradation intensity, chromaticity coordinates and it may cause open circuit in extreme cases. It requires attention.

리드 프레임의 황화(Sulfurization)는 광량 저하, 색좌표 변화 및 심한 경우 회로내의 LED 무등(Open) 불량을 일으킬 수도 있으니 주의가 필요함.

Sulfide (Sulfurization) of the lead frame may cause of storage and using with oxidizing substances together. Therefore, LED is not recommend to use and store with the below list.

: Rubber, Plain paper, lead solder cream etc.

리드 프레임 황화(Sulfurization)의 근원이 될 수 있으니 LED는 아래의 목록으로 만들어진 산화성 물질들과 함께 저장, 사용이 불가함 : 고무, 일반 종이, 납땜 크림 등

Test Report No. F690101/LF-CTSAYAA12-42152

Issued Date: 2012. 11. 28 Page 2 of 6

Sample No. : AYAA12-42152.001
Sample Description : MP 5830 Gen2 Warm White
Item No./Part No. : N/A
Materials : N/A

Heavy Metals

Test Items	Unit	Test Method	MDL	Results
Cadmium (Cd)	mg/kg	With reference to IEC 62321:2008, ICP	0.5	1.34
Lead (Pb)	mg/kg	With reference to IEC 62321:2008, ICP	5	N.D.
Mercury (Hg)	mg/kg	With reference to IEC 62321:2008, ICP	2	N.D.
Hexavalent Chromium (Cr VI)	mg/kg	With reference to IEC 62321:2008, UV-VIS	1	N.D.
Antimony (Sb)	mg/kg	With reference to EPA 3052(1996), US EPA 6010B(1996), ICP	10	N.D.
Arsenic (As)	mg/kg	With reference to EPA 3052(1996), US EPA 6010B(1996), ICP	10	N.D.
Beryllium (Be)	mg/kg	With reference to EPA 3052(1996), US EPA 6010B(1996), ICP	0.5	N.D.

Flame Retardants-PBBs/PBDEs

Test Items	Unit	Test Method	MDL	Results
Monobromobiphenyl	mg/kg	With reference to IEC 62321:2008, GC-MS	5	N.D.
Dibromobiphenyl	mg/kg	With reference to IEC 62321:2008, GC-MS	5	N.D.
Tribromobiphenyl	mg/kg	With reference to IEC 62321:2008, GC-MS	5	N.D.
Tetrabromobiphenyl	mg/kg	With reference to IEC 62321:2008, GC-MS	5	N.D.
Pentabromobiphenyl	mg/kg	With reference to IEC 62321:2008, GC-MS	5	N.D.
Hexabromobiphenyl	mg/kg	With reference to IEC 62321:2008, GC-MS	5	N.D.
Heptabromobiphenyl	mg/kg	With reference to IEC 62321:2008, GC-MS	5	N.D.
Octabromobiphenyl	mg/kg	With reference to IEC 62321:2008, GC-MS	5	N.D.
Nonabromobiphenyl	mg/kg	With reference to IEC 62321:2008, GC-MS	5	N.D.
Decabromobiphenyl	mg/kg	With reference to IEC 62321:2008, GC-MS	5	N.D.
Monobromodiphenyl ether	mg/kg	With reference to IEC 62321:2008, GC-MS	5	N.D.
Dibromodiphenyl ether	mg/kg	With reference to IEC 62321:2008, GC-MS	5	N.D.
Tribromodiphenyl ether	mg/kg	With reference to IEC 62321:2008, GC-MS	5	N.D.
Tetrabromodiphenyl ether	mg/kg	With reference to IEC 62321:2008, GC-MS	5	N.D.
Pentabromodiphenyl ether	mg/kg	With reference to IEC 62321:2008, GC-MS	5	N.D.
Hexabromodiphenyl ether	mg/kg	With reference to IEC 62321:2008, GC-MS	5	N.D.

NOTE:

- (1) N.D. = Not detected.(<MDL)
- (2) mg/kg = ppm
- (3) MDL = Method Detection Limit
- (4) - = No regulation
- (5) Negative = Undetectable / Positive = Detectable
- (6) ** = Qualitative analysis (No Unit)
- (7) * = Boiling-water-extraction:
 Negative = Absence of CrVI coating
 Positive = Presence of CrVI coating; the detected concentration in boiling-water-extraction solution is equal or greater than 0.02 mg/kg with 50 cm2 sample surface area.

This document is issued by the Company subject to its General Conditions of Service printed on back, available on request at www.sgs.com for electronic format documents, subject to Terms and Conditions for Electronic Documents at www.sgs.com. All rights reserved. No part of this document may be reproduced, stored in a retrieval system, or transmitted in any form or by any means, electronic, mechanical, photocopying, recording, or by any information storage and retrieval system, without the prior written permission of the Company. Any unauthorized use, copying, or distribution of this document is strictly prohibited. The Company shall not be held liable for any loss or damage caused by the use of this document.

SGS Korea Co., Ltd.

 322, The O valley, 555-8, Hoge-dong, Dongan-gu, Anyang-si, Gyeonggi-do, Korea 431-060
 T +82 (0)1 4956 500 F +82 (0)1 4956 559 <http://www.sgs.com> sgs@sgs.com

F052 Version5

Member of the SGS Group (Société Générale de Surveillance)



Test Report No. F690101/LF-CTSAYAA12-42152

Issued Date: 2012. 11. 28 Page 5 of 6

Testing Flow Chart for RoHS: Cd/Pb/Hg/Cr⁶⁺ /PBBs&PBDEs Testing



The samples were dissolved totally by pre-conditioning method according to above flow chart for Cd,Pb,Hg.
Section Chief : Gilsae Yi

NOTE:

- (1) N.D. = Not detected.(<MDL)
- (2) mg/kg = ppm
- (3) MDL = Method Detection Limit
- (4) - = No regulation
- (5) Negative = Undetectable / Positive = Detectable
- (6) ** = Qualitative analysis (No Unit)
- (7) * = Boiling-water-extraction:
 Negative = Absence of CrVI coating
 Positive = Presence of CrVI coating; the detected concentration in boiling-water-extraction solution is equal or greater than 0.02 mg/kg with 50 cm2 sample surface area.

This document is issued by the Company subject to its General Conditions of Service printed overleaf, available on request or accessible at <http://www.sgs.com/Products/Services/SGS%20General%20Conditions%20of%20Service.pdf> for electronic format documents, subject to Terms and Conditions for Electronic Documents at <http://www.sgs.com/Products/Services/SGS%20General%20Conditions%20of%20Service.pdf>. Any order or this document is subject to the Company's Standard Terms and Conditions for Laboratory Services. The Company's liability is limited to the amount of the fee paid for the service. The Company is not responsible for any damage or loss of any kind arising from the use of the information contained in this document. The document can also be requested in full, without prior written approval of the Company. Any reproduction, storage, copying or distribution of this document is strictly prohibited without the prior written approval of the Company. Any reproduction, storage, copying or distribution of this document is strictly prohibited without the prior written approval of the Company. Unless otherwise stated the results shown in this test report refer only to the samples tested and such samples are retained for 90 days only.



Flow Chart for Halogen Test

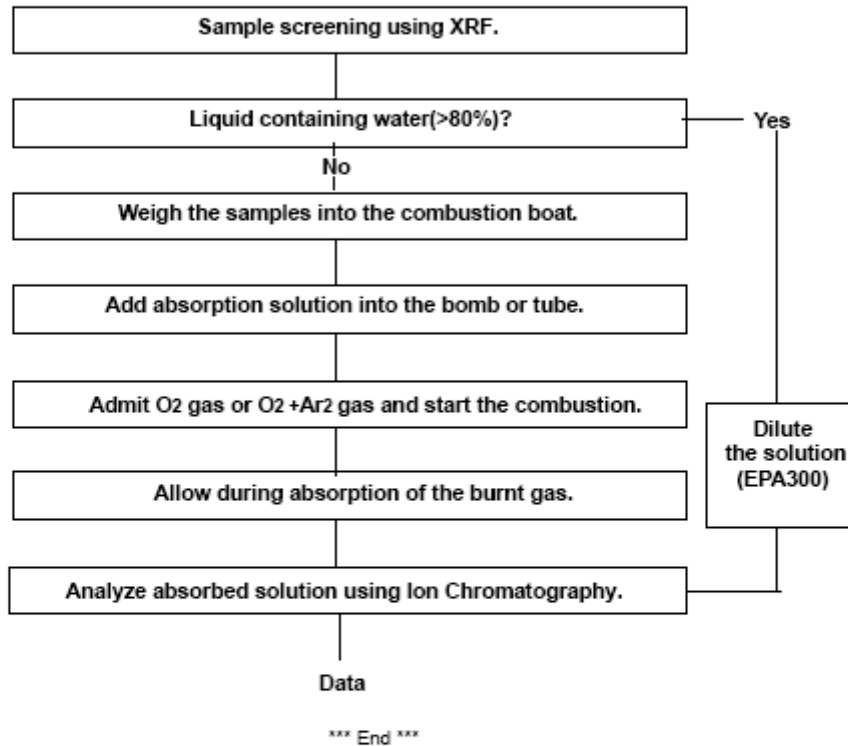

NOTE:

- (1) N.D. = Not detected.(<MDL)
- (2) mg/kg = ppm
- (3) MDL = Method Detection Limit
- (4) - = No regulation
- (5) Negative = Undetectable / Positive = Detectable
- (6) ** = Qualitative analysis (No Unit)
- (7) * = Boiling-water-extraction:
 Negative = Absence of CrVI coating
 Positive = Presence of CrVI coating; the detected concentration in boiling-water-extraction solution is equal or greater than 0.02 mg/kg with 50 cm2 sample surface area.

This document is issued by the Company subject to its General Conditions of Service and/or special conditions on request or available at www.samsungled.com for electronic format documents, subject to Terms and Conditions for Electronic Documents at www.samsungled.com/notice. All rights reserved. Infringement of this document is prohibited. Any failure of this document is not the responsibility of the Company. The Company's liability is limited to the extent of the document and the Company does not accept any liability for any damage or loss resulting from the use of this document. The Company's liability is limited to the extent of the document and the Company does not accept any liability for any damage or loss resulting from the use of this document. The Company's liability is limited to the extent of the document and the Company does not accept any liability for any damage or loss resulting from the use of this document. Unless otherwise indicated, the test report refers only to the sample(s) listed and such sample(s) are related to 30 days only.



Test Report No. F690101/LF-CTSAYAA12-42151 **Issued Date:** November 30, 2012 **Page 2 of 14**

Test Method:

SGS In-House method - Analyzed by ICP-OES, PLM, UV/VIS, LC/MS ,GC/MS and colorimetric method

Remarks:

1. The chemical analysis of specified SVHC is performed by means of currently available analytical techniques against the following SVHC related documents published by ECHA:
<http://echa.europa.eu/web/guest/candidate-list-table> (Candidate list)
http://echa.europa.eu/en/web/guest/view-article/-/journal_content/512b7526-9dd6-4872-934e-8c298c89ad99 (Potential list)
These lists are under evaluation by ECHA and may subject to change in the future.
2. In accordance with Regulation (EC) No 1907/2006, any producer or importer of articles shall notify ECHA, in accordance with paragraph 2 of Article 7, if a substance meets the criteria in Article 57 and is identified in accordance with Article 59(1) of the Regulation, if (a) the substance is present in those articles in quantities totaling over one tonne per producer or importer per year; and (b) the substance is present in those articles above a concentration of 0.1% weight by weight (w/w).
3. Article 33 of Regulation (EC) No 1907/2006 requires supplier of an article containing a substance meeting the criteria in Article 57 and identified in accordance with Article 59(1) in a concentration above 0.1% weight by weight (w/w) shall provide the recipient of the article with sufficient information, available to the supplier, to allow safe use of the article including, as a minimum, the name of that substance in the Candidate List.
4. SGS adopts the interpretation of ECHA for SVHC in article unless indicated otherwise. Detail explanation is available at the following link:
- http://webstage.contribute.sgs.net/corpreach/documents/SGS-CTS_SVHC-paper-EN-11.pdf
5. Test results in this report are based on the tested sample. This report refers to testing result of composite material group by equal weight proportion. The material in each composite test group may come from one article.
6. If a SVHC is found over the reporting limit, client is suggested to identify the component which contains the SVHC and the exact concentration of the SVHC by requesting further quantitative analysis from the laboratory.

This document is issued by the Company subject to its General Conditions of Service printed on each report, available on request or accessible at http://www.sgs.com/~/media/SGS/Service/Conditions_of_Service.pdf and its derivative forms. Documents subject to Terms and Conditions for Electronic Documents at http://www.sgs.com/~/media/SGS/Service/Conditions_of_Service.pdf. Attention is drawn to the limitation of liability, indemnification and jurisdiction clause defined herein. Any holder of this document is advised that information contained herein reflects the Company's findings at the time of its issue which may not reflect the findings of the Client's laboratory. If any. The Company's sole responsibility is to its Client and this document does not constitute advice or a guarantee from regarding all their rights and obligations under the applicable law. This document cannot be reproduced except in full without prior written consent of the Company. Any unauthorized disclosure, copying, or modification of the content or suppression of this document is subject to legal proceedings. Information is confidential. Unless otherwise stated in this test report, this report is for the use of the client only and each sample(s) are marked for 90 days only.

F052 Version 5

SGS Korea Co., Ltd.

322, The Ovalley, 555-a, Hogeje-dong, Dongan-gu, Anyang-si, Gyeonggi-do, Korea 431-050
t +82 (0)21 4608 0000 f +82 (0)21 4608 0000 <http://www.sgslab.co.kr> www.kr.sgs.com/greenlab

Member of the SGS Group (Société Générale de Surveillance)

Substance Name	CAS number	EC number	Concentration (%)	Reporting Limit (%)	Classification
Boric acid*	10043-35-3 11113-50-1	233-139-2 234-343-4	N.D.	0.005	Toxic for Reproduction
Disodium tetraborate, anhydrous*	1330-43-4 12179-04-3 1303-96-4	215-540-4	N.D.	0.005	Toxic for Reproduction
Tetraboron disodium heptaoxide, hydrate*	12267-73-1	235-541-3	N.D.	0.005	Toxic for Reproduction
Trichloroethylene	79-01-6	201-167-4	N.D.	0.05	Carcinogen
Sodium chromate*	7775-11-3	231-889-5	N.D.	0.005	Carcinogen Mutagen Toxic for Reproduction
Ammonium dichromate*	7789-09-5	232-143-1	N.D.	0.005	Carcinogen Mutagen Toxic for Reproduction
Potassium dichromate*	7778-50-9	231-906-6	N.D.	0.005	Carcinogen Mutagen Toxic for Reproduction
Potassium chromate*	7789-00-6	232-140-5	N.D.	0.005	Carcinogen Mutagen

This document is issued by the Company subject to its General Conditions of Service printed on sheet, available on request or accessible at <http://www.sgs.com/Company/Conditions.aspx> and, for clients' Personal Documents, subject to Terms and Conditions for Electronic Documents at <http://www.sgs.com/Company/Conditions.aspx>. Attention is drawn to the limitation of liability, indemnification and jurisdiction clauses defined therein. Any holder of this document is advised that electronic format does not ensure the Company's findings in the form of its information only and with the risk of data transmission. It is the Company's sole responsibility as to Client and this document does not constitute advice or information from involving all their rights and obligations under the respective documents. This document cannot be reproduced except in full, without prior written consent of the Company. Any unauthorized download, usage or publication of the content or reproduction of this document is prohibited and offenders may be prosecuted to the fullest extent of the law. Unless otherwise stated, the results shown in this test report refer only to the sample(s) tested and each sample(s) determined for 30 days only.

F052 Version 5

SGS Korea Co., Ltd.

322, The Ovalley, 555-a, Hogeje-dang, Dongan-gu, Anyang-si, Gyeonggi-do, Korea 431-050
 T+82 (0)31 4608 000 F+82 (0)31 4608 000 <http://www.sgslab.co.kr> www.kr.sgs.com/gremlab

Member of the SGS Group (Società Générale de Surveillance)

Substance Name	CAS number	EC number	Concentration (%)	Reporting Limit (%)	Classification
1,2-Dichloroethane	107-06-2	203-458-1	N.D.	0.05	Carcinogenic
2,2'-dichloro-4,4'-methylenedianiline (MOCA)	101-14-4	202-918-9	N.D.	0.05	Carcinogenic
2-Methoxyaniline o-Anisidine	90-04-0	201-963-1	N.D.	0.05	Carcinogenic
4-(1,1,3,3-tetramethylbutyl)phenol, (4-tert-Octylphenol)	140-66-9	205-426-2	N.D.	0.05	Equivalent level of concern having probable serious effects to the environment
Aluminosilicate Refractory Ceramic Fibres* (RCF)	650-017-00-8 (Index no.)	-	N.D.	0.005	Carcinogenic
Arsenic acid*	7778-39-4	231-901-9	N.D.	0.005	Carcinogenic
Bis(2-methoxyethyl) ether	111-96-6	203-924-4	N.D.	0.05	Toxic for reproduction
Bis(2-methoxyethyl) phthalate	117-82-8	204-212-6-	N.D.	0.05	Toxic for reproduction
Calcium arsenate*	7778-44-1	231-904-5	N.D.	0.005	Carcinogenic
Dichromium tris(chromate)*	24613-89-6	246-356-2	N.D.	0.005	Carcinogenic
Formaldehyde, oligomeric reaction products with aniline (technical MDA)	25214-70-4	500-036-1	N.D.	0.05	Carcinogenic
Lead diazide*	13424-46-9	236-542-1	N.D.	0.005	Toxic for reproduction
Lead dipicrate*	6477-64-1	229-335-2	N.D.	0.005	Toxic for reproduction
Lead styphnate*	15245-44-0	239-290-2	N.D.	0.005	Toxic for reproduction
N,N-dimethylacetamide (DMAC)	127-19-5	204-826-4	N.D.	0.05	Toxic for reproduction
Pentazinc chromate octahydroxide*	49663-84-5	256-418-0	N.D.	0.005	Carcinogenic
Phenolphthalein	77-09-8	201-004-7	N.D.	0.05	Carcinogenic
Potassium hydroxyoctaoxidincatedichromate*	11103-86-9	234-329-8	N.D.	0.005	Carcinogenic
Trilead diarsenate*	3687-31-8	222-979-5	N.D.	0.005	Carcinogenic Toxic for reproduction
Zirconia Aluminosilicate Refractory Ceramic Fibres (Zr-RCF)*	650-017-00-8 (Index no.)	-	N.D.	0.005	Carcinogenic

This document is issued by the Company subject to its General Conditions of Service printed on sheet, available on request or accessible at <http://www.sgs.com/ServiceConditions.aspx> and, for documents issued electronically, subject to Terms and Conditions for Electronic Documents at <http://www.sgs.com/ServiceConditions.aspx>. Attention is drawn to the limitation of liability, indemnification and jurisdiction clause defined therein. Any holder of this document is advised that information contained herein reflects the Company's findings at the time of its issuance only and will be obsolete if Client's circumstances change. The Company's sole responsibility is to the Client and this document does not constitute advice or certification from any other party. All rights and obligations under this document are reserved. This document cannot be reproduced, stored in a retrieval system, or transmitted in any form or by any means, electronic, mechanical, photocopying, recording, or otherwise, without the prior written approval of the Company. Any use of this document, in whole or in part, without the prior written approval of the Company is prohibited. All trademarks are the property of their respective owners. All other trademarks are the property of their respective owners. All rights reserved. © 2012 SGS SA.

F052 Version 5

SGS Korea Co., Ltd.

 322, The Ovalley, 555-a, Hoge-dong, Dongan-gu, Anyang-si, Gyeonggi-do, Korea 431-050
 t+82 (0)31 4608 000 f+82 (0)31 4608 000 <http://www.sgslab.co.kr> www.kr.sgs.com/guestlab

Member of the SGS Group (Société Générale de Surveillance)



Test Report No. F690101/LF-CTSAYAA12-42151 **Issued Date:** November 30, 2012 **Page 9 of 14**

The potential Substances

Substance Name	CAS number	EC number	Concentration (%)	Reporting Limit (%)	Classification
Bis(pentabromophenyl) ether (DecaBDE)	1163-19-5	214-604-9	N.D.	0.05	PBT vPvB
Pentacosafuorotridecanoic acid	72629-94-8	276-745-2	N.D.	0.05	vPvB
Tricosafuorododecanoic acid	307-55-1	206-203-2	N.D.	0.05	vPvB
Henicosafuoroundecanoic acid	2058-94-8	218-165-4	N.D.	0.05	vPvB
Heptacosafuorotetradecanoic acid	376-06-7	206-803-4	N.D.	0.05	vPvB
4-(1,1,3,3-tetramethylbutyl)phenol, ethoxylated - covering well-defined substances and UVCB substances, polymers and homologues	-	-	N.D.	0.05	Equivalent level of concern - probable serious effects on the environment
4-Nonylphenol, branched and linear - substances with a linear and/or branched alkyl chain with a carbon number of 9 covalently bound in position 4 to phenol, covering also UVCB- and well-defined substances which include any of the individual isomers or a combination thereof	-	-	N.D.	0.05	Equivalent level of concern - probable serious effects on the environment
Diazeno-1,2-dicarboxamide (C,C'-azodi(formamide))	123-77-3	204-650-8	N.D.	0.05	Equivalent level of concern - probable serious effects on human health
Cyclohexane-1,2-dicarboxylic anhydride (Hexahydrophthalic anhydride - HHPA)	85-42-7	201-604-9	N.D.	0.05	Equivalent level of concern - probable serious effects on human health

This document is issued by the Company subject to its General Conditions of Service printed on each analytical report or request or available at <http://www.sgs.com> and for clients' internal use only. It is intended for the client's internal use only. The Company's sole responsibility is to its Client and this document does not constitute an offer of any service or product. The Company's liability is limited to the extent of the contract. This document cannot be reproduced without the written consent of the Company. Any unauthorized alteration, copying or distribution of this document is prohibited and offenders may be prosecuted to the full extent of the law. Other alterations of this report shall be the responsibility of the client and each sample(s) are marked for ID (see page 10).

F052 Version 5

SGS Korea Co., Ltd.

322, The Ovalley, 555-s, Hoge-dong, Dongan-gu, Anyang-si, Gyeonggi-do, Korea 431-050
 t+82 (0)31 4608 000 f+82 (0)31 4608 000 <http://www.sgs.com> www.kr.sgs.com www.kr.sgs.com/psnlab

Member of the SGS Group (Société Générale de Surveillance)

Substance Name	CAS number	EC number	Concentration (%)	Reporting Limit (%)	Classification
Trilead dioxide phosphonate*	12141-20-7	235-252-2	N.D.	0.005	Toxic for reproduction
Furan	110-00-9	203-727-3	N.D.	0.05	Carcinogenic
Propylene oxide; 1,2-epoxypropane; methyloxirane	75-56-9	200-879-2	N.D.	0.05	Carcinogenic Mutagenic
Diethyl sulphate	64-67-5	200-589-6	N.D.	0.05	Carcinogenic Mutagenic
Dimethyl sulphate	77-78-1	201-058-1	N.D.	0.05	Carcinogenic
3-ethyl-2-methyl-2-(3-methylbutyl)-1,3-oxazolidine	143860-04-2	421-150-7	N.D.	0.05	Toxic for reproduction
Dinoseb	88-85-7	201-861-7	N.D.	0.05	Toxic for reproduction
4,4'-methylenedi-o-toluidine	838-88-0	212-658-8	N.D.	0.05	Carcinogenic
4,4'-oxydianiline and its salts	101-80-4	202-977-0	N.D.	0.05	Carcinogenic Mutagenic
4-Aminoazobenzene; 4-Phenylazoaniline	60-09-3	200-453-6	N.D.	0.05	Carcinogenic
4-methyl-m-phenylenediamine (2,4-toluene-diamine)	95-80-7	202-453-1	N.D.	0.05	Carcinogenic
6-methoxy-m-toluidine (p-cresidine)	120-71-8	204-419-1	N.D.	0.05	Carcinogenic
Biphenyl-4-ylamine	92-67-1	202-177-1	N.D.	0.05	Carcinogenic
o-aminoazotoluene	97-56-3	202-591-2	N.D.	0.05	Carcinogenic
o-Toluidine; 2-Aminotoluene	95-53-4	202-429-0	N.D.	0.05	Carcinogenic
N-methylacetamide	79-16-3	201-182-6	N.D.	0.05	Toxic for reproduction
1-bromopropane; n-propyl bromide	106-94-5	203-445-0	N.D.	0.05	Toxic for reproduction

This document is issued by the Company subject to its General Conditions of Service printed on request, available on request or accessible at <http://www.sgs.com/ServiceConditions.aspx> and, for electronic format documents, subject to Terms and Conditions for Electronic Documents at <http://www.sgs.com/ServiceConditions.aspx>. Attention is drawn to the limitation of liability, indemnification and jurisdiction clause defined therein. Any holder of this document is advised that the information contained herein reflects the Company's findings and the level of its intervention only and will be limited to the Company's sole responsibility as its Client and this document does not constitute advice in relation to their rights and obligations under the applicable law. This document cannot be reproduced, stored in full, without prior written approval of the Company. Any circulation of partial, forged or falsified copies of this document is strictly prohibited and will be prosecuted to the full extent of the law. Unless otherwise stated, the results shown in this test report refer only to the sample(s) tested and each sample(s) are marked by 99.999.999.

F052 Version 5

SGS Korea Co., Ltd.

 322, The Ovalley, 555-a, Hogeje-dong, Dongan-gu, Anyang-si, Gyeonggi-do, Korea 431-050
 t+82 (0)31 4608 000 f+82 (0)31 4608 000 <http://www.sgslab.co.kr> www.kr.sgs.com/guestlab

Member of the SGS Group (Società Générale de Surveillance)

Revision History

Date	No.	Revision History	Writer	
			Drawn	Approved
2013.2.08	001	New version	W.H Jung	Y.T KIM

Looking for pricing, stock, or lifecycle information?

Click below to explore more details on WIN SOURCE:

- ⊖ [View SPMWHT541MD5WAT0S2 on WIN SOURCE](#)
- ⊖ [Samsung Information](#)

Optimize Your Supply Chain with WIN SOURCE Solutions

- ✓ Global Sourcing Solution
- ✓ Obsolete Management
- ✓ Cost Control Management
- ✓ Shortage Management
- ✓ Alternative Solution
- ✓ Excess Inventory Management