



THE DATASHEET OF DS36276MX/NOPB



DS36276

DS36276 FAILSAFE Multipoint Transceiver



Literature Number: SNLS085A

DS36276 FAILSAFE Multipoint Transceiver

General Description

The DS36276 FAILSAFE Multipoint Transceiver is designed for use on bi-directional differential busses. It is compatible with existing TIA/EIA-485 transceivers, however, it offers an additional feature not supported by standard transceivers.

The FAILSAFE feature guarantees the receiver output to a known state when the Interface is in the following conditions: Floating Line, Idle Line (no active drivers), and Line Fault conditions (open or short). The receiver output is in a HIGH state for the following conditions: OPEN Inputs, Terminated Inputs (50Ω), and SHORTED Inputs.

FAILSAFE is a highly desirable feature when the transceivers are used with Asynchronous Controllers such as UARTs.

Features

- FAILSAFE receiver, RO = HIGH for:
 - OPEN inputs
 - Terminated inputs
 - SHORTED inputs
- Compatible with popular interface standards:
 - TIA/EIA-485 (RS-485)
 - TIA/EIA-422-A (RS-422-A)
 - CCITT Recommendation V.11
- Bi-Directional Transceiver
 - Designed for multipoint transmission
- Separate driver input, driver enable, receiver enable, and receiver output for maximum flexibility
- Wide bus common mode range
 - (-7V to +12V)
- Pin compatible with: DS75176B, DS96176, DS3695 and SN75176A and B
- Available in SOIC package

Connection and Logic Diagram

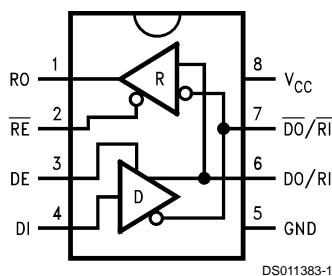

Order Number DS36276M
See NS Package Number M08A

Driver

Inputs			Outputs	
\overline{RE}	DE	DI	DO/RI	$\overline{DO}/\overline{RI}$
X	H	H	H	L
X	H	L	L	H
X	L	X	Z	Z

Receiver

Inputs			Output
\overline{RE}	DE	RI- \overline{RI}	RO
L	L	$\geq 0V$	H
L	L	$\leq -500\text{ mV}$	L
H	X	X	Z

Receiver FAILSAFE

Inputs			Output
\overline{RE}	DE	RI- \overline{RI}	RO
L	L	SHORTED	H
L	L	OPEN	H
H	X	X	Z

Absolute Maximum Ratings (Note 1)

If Military/Aerospace specified devices are required, please contact the National Semiconductor Sales Office/Distributors for availability and specifications.

Supply Voltage (V_{CC})	7V
Input Voltage (DE, \overline{RE} , and DI)	5.5V
Driver Output Voltage/ Receiver Input Voltage	-10V to +15V
Receiver Output Voltage (RO)	5.5V
Maximum Package Power Dissipation @ +25°C M Package (derate 5.8 mW/°C above +25°C)	726 mW
Storage Temperature Range	-65°C to +150°C

Lead Temperature (Soldering 4 sec.)	260°C
Max Junction Temperature	150°C
ESD Rating (HBM, 1.5 k Ω , 100 pF)	≥ 6.0 kV

Recommended Operating Conditions

	Min	Max	Units
Supply Voltage, V_{CC}	4.75	5.25	V
Bus Voltage	-7	+12	V
Operating Temperature (T_A) DS36276	0	+70	°C

Electrical Characteristics (Notes 2, 4)

Over recommended Supply Voltage and Operating Temperature ranges, unless otherwise specified.

Symbol	Parameter	Conditions	Min	Typ	Max	Units		
DRIVER CHARACTERISTICS								
V_{OD}	Differential Output Voltage	$I_O = 0$ mA (No Load)	1.5	4.8	6.0	V		
V_{oDO}	Output Voltage	$I_O = 0$ mA (Output to GND)	0		6.0	V		
$\overline{V_{oDO}}$	Output Voltage		0		6.0	V		
V_{T1}	Differential Output Voltage (Termination Load)	$R_L = 54\Omega$ (485)	(Figure 1)		1.5	2.0	5.0	V
		$R_L = 100\Omega$ (422)			2.0	2.3	5.0	V
ΔV_{T1}	Balance of V_{T1} $ V_{T1} - \overline{V_{T1}} $	$R_L = 54\Omega$	(Note 3)		-0.2	0.07	+0.2	V
		$R_L = 100\Omega$			-0.2	0.07	+0.2	V
V_{OS}	Driver Common Mode Output Voltage	$R_L = 54\Omega$	(Figure 1)		0	2.5	3.0	V
		$R_L = 100\Omega$			0	2.3	3.0	V
ΔV_{OS}	Balance of V_{OS} $ V_{OS} - \overline{V_{OS}} $	$R_L = 54\Omega$	(Note 3)		-0.2	0.08	+0.2	V
		$R_L = 100\Omega$			-0.2	0.08	+0.2	V
I_{OSD}	Driver Short-Circuit Output Current	$V_O = +12V$	(Figure 3)			134	290	mA
		$V_O = V_{CC}$				140		mA
		$V_O = 0V$				-140		mA
		$V_O = -7V$				-180	-290	mA
RECEIVER CHARACTERISTICS								
V_{TH}	Differential Input High Threshold Voltage (Note 5)	$V_O = V_{OH}$, $I_O = -0.4$ mA $-7V \leq V_{CM} \leq +12V$		-0.18	0	V		
V_{TL}	Differential Input Low Threshold Voltage (Note 5)	$V_O = V_{OL}$, $I_O = 8.0$ mA $-7V \leq V_{CM} \leq +12V$	-0.5	-0.23		V		
V_{HST}	Hysteresis (Note 6)	$V_{CM} = 0V$		50		mV		
I_{IN}	Line Input Current ($V_{CC} = 4.75V, 5.25V, 0V$)	Other Input = 0V DE = V_{IH} (Note 7)	$V_I = +12V$		0.7	1.0	mA	
			$V_I = -7V$		-0.5	-0.8	mA	
I_{OSR}	Short Circuit Current	$V_O = 0V$	RO	-5.0	-30	-85	mA	
I_{OZ}	TRI-STATE® Leakage Current	$V_O = 0.4$ to 2.4V		-20		+20	μA	
V_{OH}	Output High Voltage (Figure 12)	$V_{ID} = 0V$, $I_{OH} = -0.4$ mA		2.5	3.5		V	
		$V_{ID} = OPEN$, $I_{OH} = -0.4$ mA		2.5	3.5		V	
V_{OL}	Output Low Voltage (Figure 12)	$V_{ID} = -0.5V$, $I_{OL} = +8$ mA		0.25	0.6	V		
		$V_{ID} = -0.5V$, $I_{OL} = +16$ mA		0.35	0.7	V		
R_{IN}	Input Resistance		12	19		k Ω		

Electrical Characteristics (Notes 2, 4) (Continued)

Over recommended Supply Voltage and Operating Temperature ranges, unless otherwise specified.

Symbol	Parameter	Conditions	Min	Typ	Max	Units
DEVICE CHARACTERISTICS						
V_{IH}	High Level Input Voltage		2.0		V_{CC}	V
V_{IL}	Low Level Input Voltage		GND		0.8	V
I_{IH}	High Level Input Current	$V_{IH} = 2.4V$			20	μA
I_{IL}	Low Level Input Current	$V_{IL} = 0.4V$			-100	μA
V_{CL}	Input Clamp Voltage	$I_{CL} = -18\text{ mA}$		-0.75	-1.5	V
I_{CC}	Output Low Voltage	$DE = 3V, \overline{RE} = 0V, DI = 0V$		42	60	mA
I_{CCR}	Supply Current	$DE = 0V, \overline{RE} = 0V, DI = 0V$		28	45	mA
I_{CCD}	(No Load)	$DE = 3V, \overline{RE} = 3V, DI = 0V$		43	60	mA
I_{CCX}		$DE = 0V, \overline{RE} = 3V, DI = 0V$		31	50	mA

Switching Characteristics (Note 4)

Over recommended Supply Voltage and Operating Temperature ranges, unless otherwise specified.

Symbol	Parameter	Conditions	Min	Typ	Max	Units
DRIVER CHARACTERISTICS						
t_{PLHD}	Diff. Prop. Delay Low to High	$R_L = 54\Omega$ $C_L = 50\text{ pF}$ $C_D = 50\text{ pF}$ (Figures 4, 5)	7	21	60	ns
t_{PHLD}	Diff. Prop. Delay High to Low		7	19	60	ns
t_{SKD}	Diff. Skew ($ t_{PLHD} - t_{PHLD} $)		2	10		ns
t_r	Diff. Rise Time		12	50		ns
t_f	Diff. Fall Time		12	50		ns
t_{PLH}	Prop. Delay Low to High	$R_L = 27\Omega, C_L = 15\text{ pF}$ (Figures 6, 7)		22	45	ns
t_{PHL}	Prop. Delay High to Low			22	45	ns
t_{PZH}	Enable Time Z to High	$R_L = 110\Omega$ $C_L = 50\text{ pF}$ (Figure 8 – Figure 11)		32	55	ns
t_{PZL}	Enable Time Z to Low			32	65	ns
t_{PHZ}	Disable Time High to Z			22	55	ns
t_{PLZ}	Disable Time Low to Z			16	55	ns
RECEIVER CHARACTERISTICS						
t_{PLH}	Prop. Delay Low to High	$V_{ID} = -1.5V\text{ to }+1.5V$ $C_L = 15\text{ pF}$ (Figures 13, 14)	15	40	70	ns
t_{PHL}	Prop. Delay High to Low		15	42	70	ns
t_{SK}	Skew ($ t_{PLH} - t_{PHL} $)		2	15		ns
t_{PZH}	Enable Time Z to High	$C_L = 15\text{ pF}$ (Figures 15, 16)		15	50	ns
t_{PZL}	Enable Time Z to Low			17	50	ns
t_{PHZ}	Disable Time High to Z			24	50	ns
t_{PLZ}	Disable Time Low to Z			19	50	ns

Note 1: "Absolute Maximum Ratings" are those values beyond which the safety of the device cannot be guaranteed. They are not meant to imply that the devices should be operated at these limits. The tables of "Electrical Characteristics" specify conditions for device operation.

Note 2: Current into device pins is defined as positive. Current out of device pins is defined as negative. All voltages are referenced to ground unless otherwise specified.

Note 3: $\Delta |V_{T1}|$ and $\Delta |V_{OS}|$ are changes in magnitude of V_{T1} and V_{OS} , respectively, that occur when the input changes state.

Note 4: All typicals are given for $V_{CC} = 5.0V$ and $T_A = +25^\circ C$.

Note 5: Threshold parameter limits specified as an algebraic value rather than by magnitude.

Note 6: Hysteresis defined as $V_{HST} = V_{TH} - V_{TL}$.

Note 7: I_{IN} includes the receiver input current and driver TRI-STATE leakage current.

Parameter Measurement Information

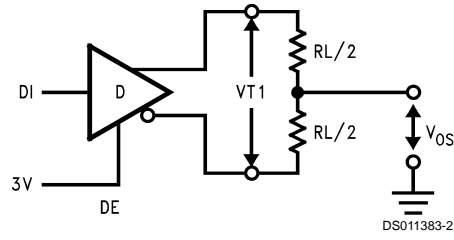

FIGURE 1. Driver V_{T1} and V_{OS} Test Circuit

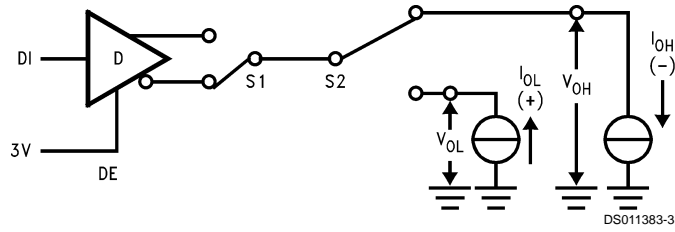

FIGURE 2. Driver V_{OH} and V_{OL} Test Circuit

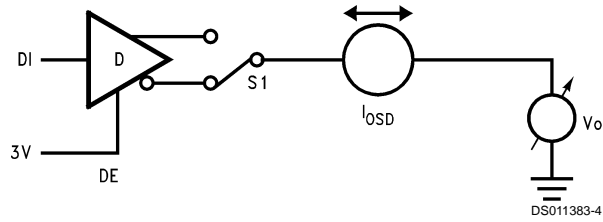

FIGURE 3. Driver Short Circuit Test Circuit

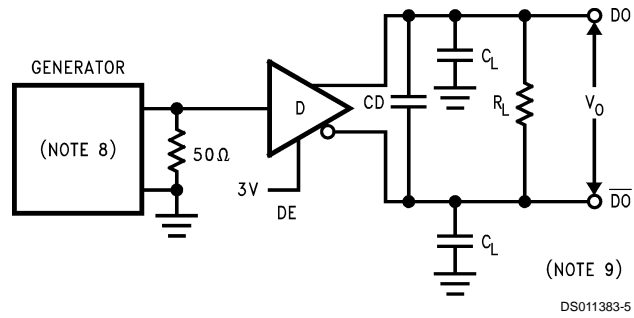
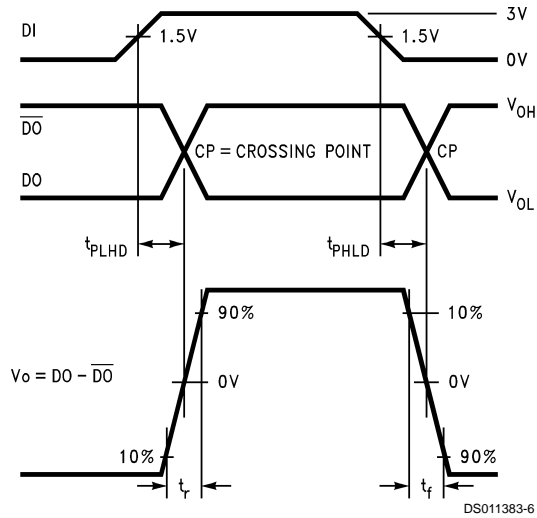

FIGURE 4. Driver Differential Propagation Delay and Transition Time Test Circuit

Parameter Measurement Information (Continued)



DS011383-6

FIGURE 5. Driver Differential Propagation Delays and Transition Times

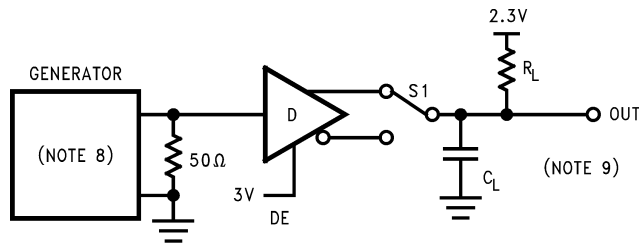

DS011383-7

FIGURE 6. Driver Propagation Delay Test Circuit

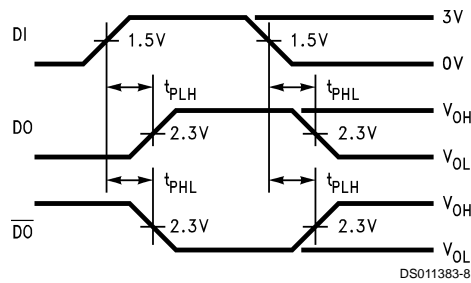

DS011383-8

FIGURE 7. Driver Propagation Delays

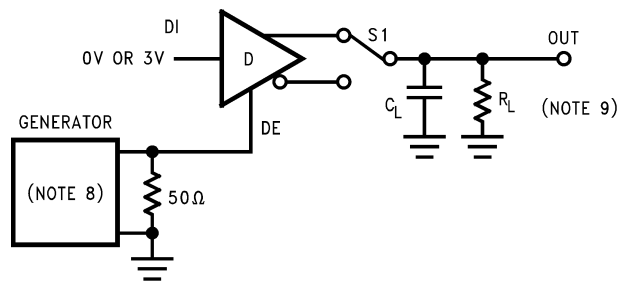

DS011383-9

S1 to DO for DI = 3V
S1 to DO-bar for DI = 0V

FIGURE 8. Driver TRI-STATE Test Circuit (t_{PZH} , t_{PHZ})

Parameter Measurement Information (Continued)

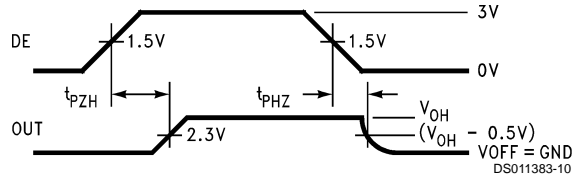
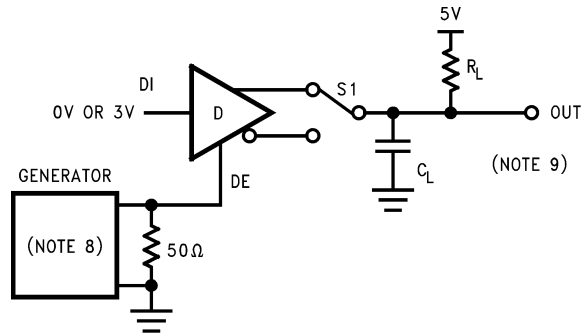

FIGURE 9. Driver TRI-STATE Delays (t_{PZH}, t_{PHZ})



S1 to DO for DI = 0V
S1 to \overline{DO} for DI = 3V

FIGURE 10. Driver TRI-STATE Test Circuit (t_{PZL}, t_{PLZ})

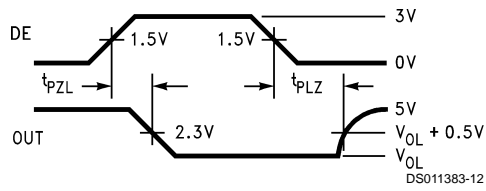

FIGURE 11. Driver TRI-STATE Delays (t_{PZL}, t_{PLZ})

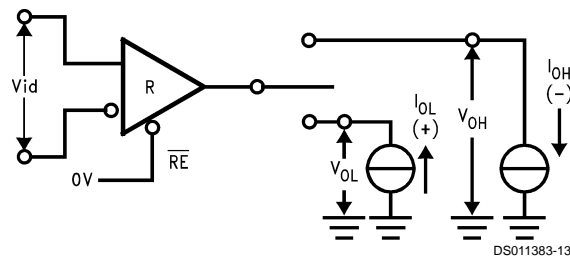

FIGURE 12. Receiver V_{OH} and V_{OL}

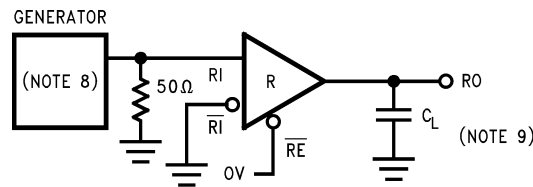

FIGURE 13. Receiver Propagation Delay Test Circuit

Parameter Measurement Information (Continued)

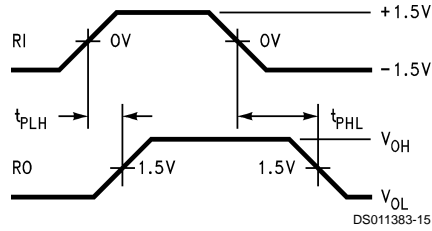

FIGURE 14. Receiver Propagation Delays

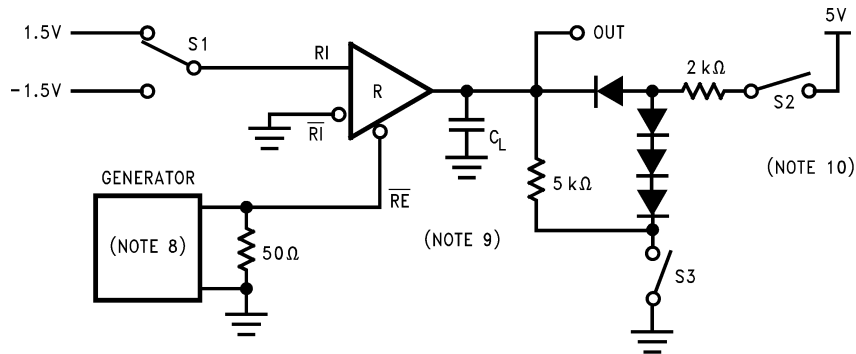
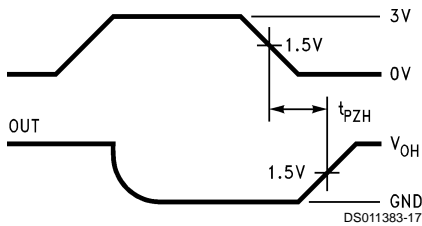
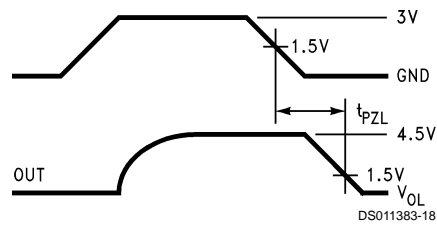

FIGURE 15. Receiver TRI-STATE Delay Test Circuit



S1 1.5V
S2 OPEN
S3 CLOSED



S1 -1.5V
S2 CLOSED
S3 OPEN

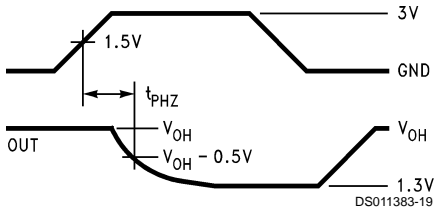

S1 1.5V
S2 CLOSED
S3 CLOSED

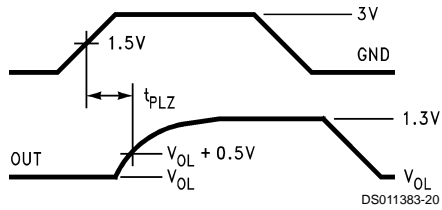

S1 -1.5V
S2 CLOSED
S3 CLOSED

Note 8: The input pulse is supplied by a generator having the following characteristics: $f = 1.0 \text{ MHz}$, 50% duty cycle, t_r and $t_f < 6.0 \text{ ns}$, $Z_O = 50\Omega$.

Note 9: C_L includes probe and stray capacitance.

Note 10: Diodes are 1N916 or equivalent.

FIGURE 16. Receiver Enable and Disable Timing

Typical Performance Characteristics

Differential Output Voltage vs Output Current

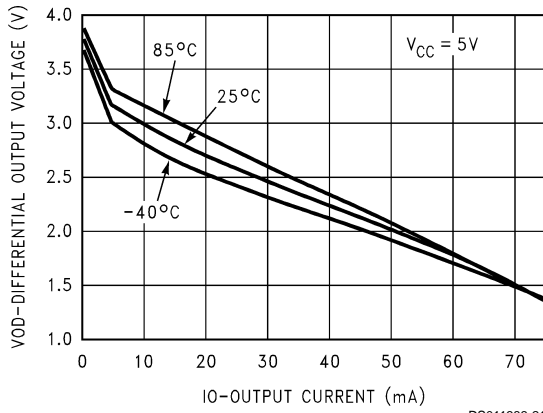

Differential Output Voltage vs Output Current

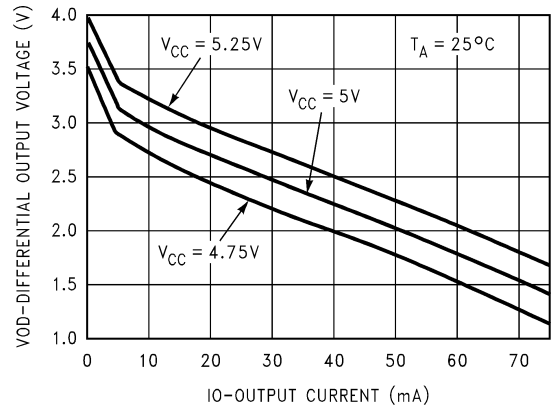

Driver VOH vs IOH vs VCC

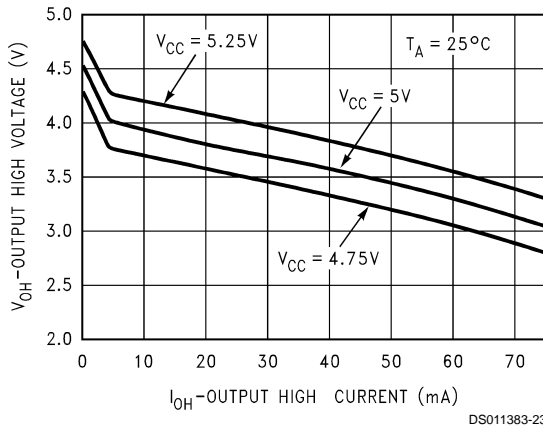

Driver VOH vs IOH vs Temperature

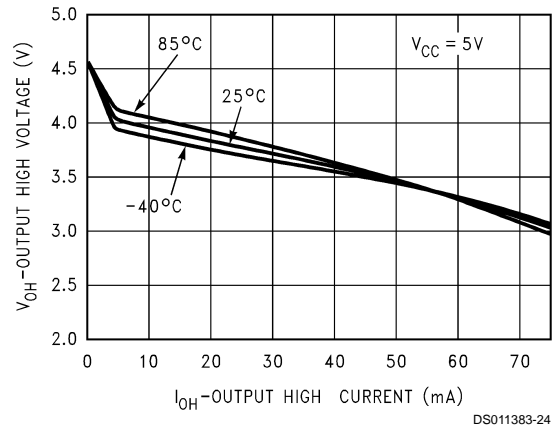

Driver VOL vs IOL vs VCC

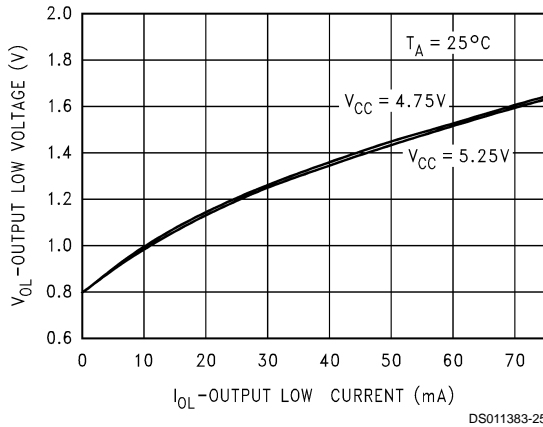

Driver VOL vs IOL vs Temperature

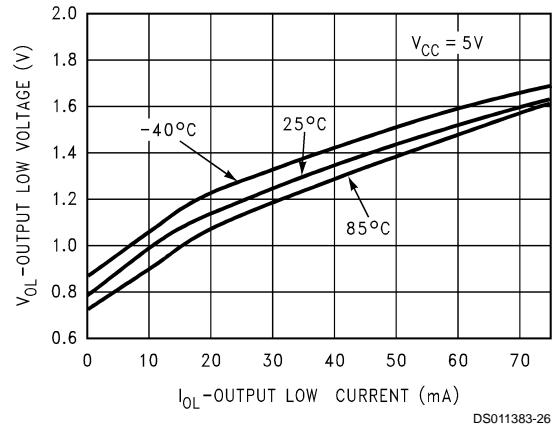

Typical Performance Characteristics (Continued)

Receiver V_{OH} vs I_{OH} vs V_{CC}

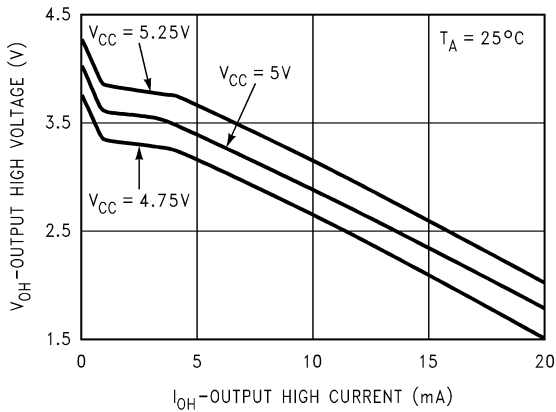

Receiver V_{OH} vs I_{OH} vs Temperature

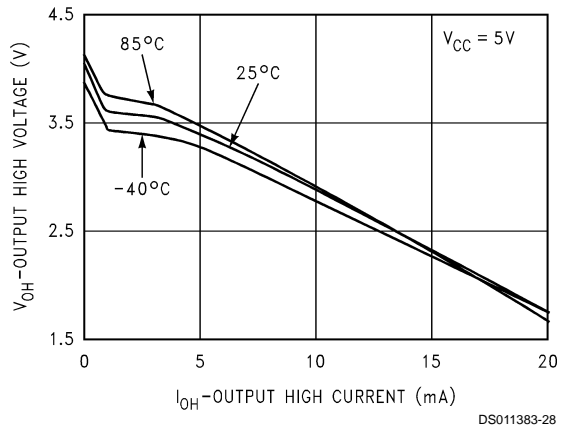

Receiver V_{OL} vs I_{OL} vs V_{CC}

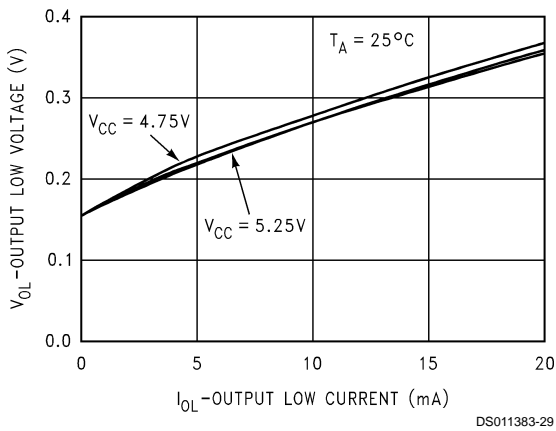

Receiver V_{OL} vs I_{OL} vs Temperature

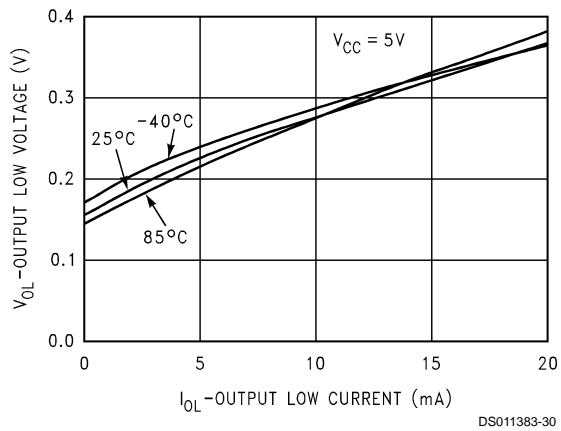

Supply Current vs Supply Voltage

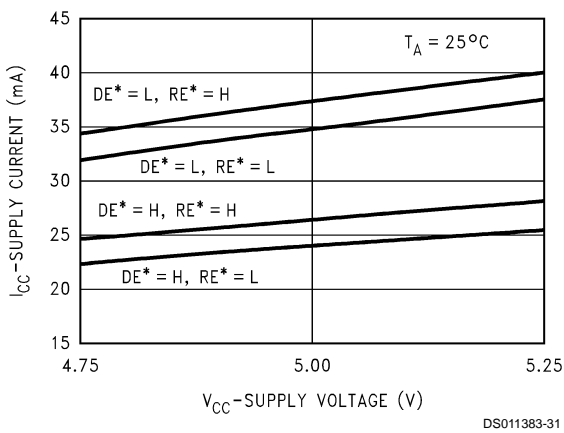

Supply Current vs Temperature

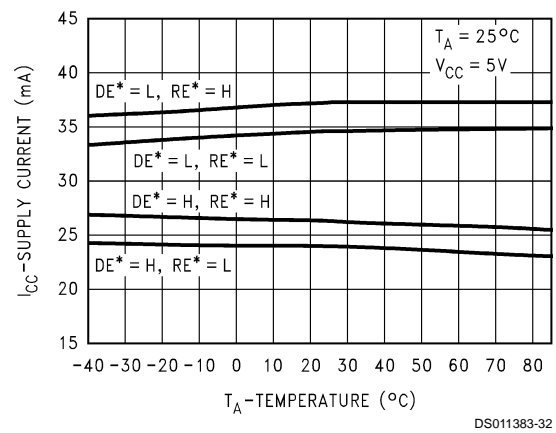

Typical Performance Characteristics (Continued)

Voltage Output vs Voltage Input
(Hysteresis)

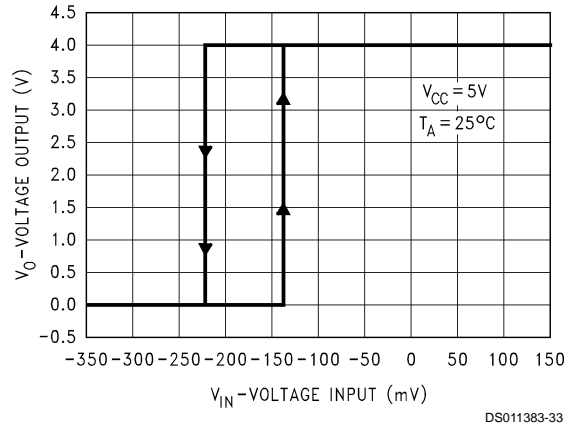

Physical Dimensions inches (millimeters) unless otherwise noted

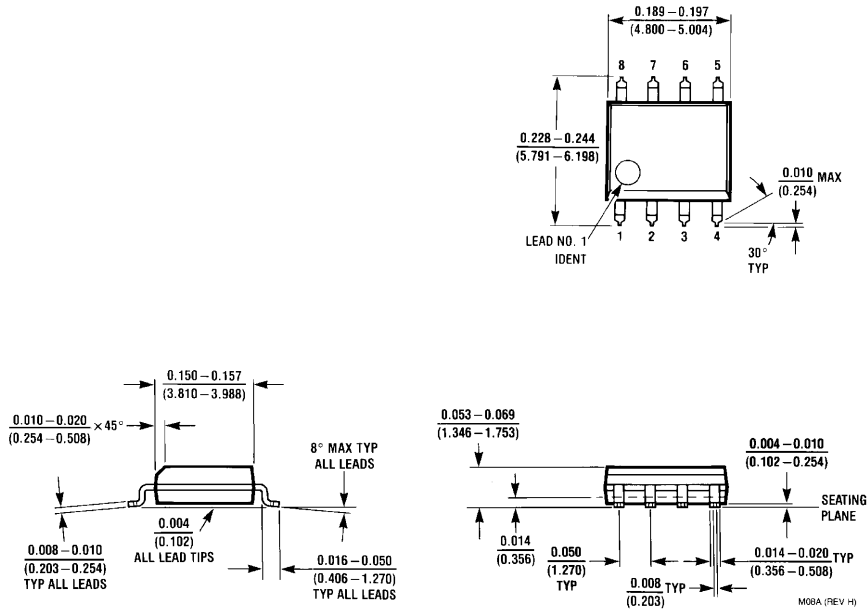

Order Number DS36276M
NS Package Number M08A

LIFE SUPPORT POLICY

NATIONAL'S PRODUCTS ARE NOT AUTHORIZED FOR USE AS CRITICAL COMPONENTS IN LIFE SUPPORT DEVICES OR SYSTEMS WITHOUT THE EXPRESS WRITTEN APPROVAL OF THE PRESIDENT AND GENERAL COUNSEL OF NATIONAL SEMICONDUCTOR CORPORATION. As used herein:

1. Life support devices or systems are devices or systems which, (a) are intended for surgical implant into the body, or (b) support or sustain life, and whose failure to perform when properly used in accordance with instructions for use provided in the labeling, can be reasonably expected to result in a significant injury to the user.
2. A critical component is any component of a life support device or system whose failure to perform can be reasonably expected to cause the failure of the life support device or system, or to affect its safety or effectiveness.



National Semiconductor Corporation
Americas
Email: support@nsc.com

National Semiconductor Europe
Fax: +49 (0) 180-530 85 86
Email: europe.support@nsc.com
Deutsch Tel: +49 (0) 69 9508 6208
English Tel: +44 (0) 870 24 0 2171
Français Tel: +33 (0) 1 41 91 8790

National Semiconductor Asia Pacific Customer Response Group
Tel: 65-2544466
Fax: 65-2504466
Email: ap.support@nsc.com

National Semiconductor Japan Ltd.
Tel: 81-3-5639-7560
Fax: 81-3-5639-7507

www.national.com

IMPORTANT NOTICE

Texas Instruments Incorporated and its subsidiaries (TI) reserve the right to make corrections, modifications, enhancements, improvements, and other changes to its products and services at any time and to discontinue any product or service without notice. Customers should obtain the latest relevant information before placing orders and should verify that such information is current and complete. All products are sold subject to TI's terms and conditions of sale supplied at the time of order acknowledgment.

TI warrants performance of its hardware products to the specifications applicable at the time of sale in accordance with TI's standard warranty. Testing and other quality control techniques are used to the extent TI deems necessary to support this warranty. Except where mandated by government requirements, testing of all parameters of each product is not necessarily performed.

TI assumes no liability for applications assistance or customer product design. Customers are responsible for their products and applications using TI components. To minimize the risks associated with customer products and applications, customers should provide adequate design and operating safeguards.

TI does not warrant or represent that any license, either express or implied, is granted under any TI patent right, copyright, mask work right, or other TI intellectual property right relating to any combination, machine, or process in which TI products or services are used. Information published by TI regarding third-party products or services does not constitute a license from TI to use such products or services or a warranty or endorsement thereof. Use of such information may require a license from a third party under the patents or other intellectual property of the third party, or a license from TI under the patents or other intellectual property of TI.

Reproduction of TI information in TI data books or data sheets is permissible only if reproduction is without alteration and is accompanied by all associated warranties, conditions, limitations, and notices. Reproduction of this information with alteration is an unfair and deceptive business practice. TI is not responsible or liable for such altered documentation. Information of third parties may be subject to additional restrictions.

Resale of TI products or services with statements different from or beyond the parameters stated by TI for that product or service voids all express and any implied warranties for the associated TI product or service and is an unfair and deceptive business practice. TI is not responsible or liable for any such statements.

TI products are not authorized for use in safety-critical applications (such as life support) where a failure of the TI product would reasonably be expected to cause severe personal injury or death, unless officers of the parties have executed an agreement specifically governing such use. Buyers represent that they have all necessary expertise in the safety and regulatory ramifications of their applications, and acknowledge and agree that they are solely responsible for all legal, regulatory and safety-related requirements concerning their products and any use of TI products in such safety-critical applications, notwithstanding any applications-related information or support that may be provided by TI. Further, Buyers must fully indemnify TI and its representatives against any damages arising out of the use of TI products in such safety-critical applications.

TI products are neither designed nor intended for use in military/aerospace applications or environments unless the TI products are specifically designated by TI as military-grade or "enhanced plastic." Only products designated by TI as military-grade meet military specifications. Buyers acknowledge and agree that any such use of TI products which TI has not designated as military-grade is solely at the Buyer's risk, and that they are solely responsible for compliance with all legal and regulatory requirements in connection with such use.

TI products are neither designed nor intended for use in automotive applications or environments unless the specific TI products are designated by TI as compliant with ISO/TS 16949 requirements. Buyers acknowledge and agree that, if they use any non-designated products in automotive applications, TI will not be responsible for any failure to meet such requirements.

Following are URLs where you can obtain information on other Texas Instruments products and application solutions:

Products

Audio	www.ti.com/audio
Amplifiers	amplifier.ti.com
Data Converters	dataconverter.ti.com
DLP® Products	www.dlp.com
DSP	dsp.ti.com
Clocks and Timers	www.ti.com/clocks
Interface	interface.ti.com
Logic	logic.ti.com
Power Mgmt	power.ti.com
Microcontrollers	microcontroller.ti.com
RFID	www.ti-rfid.com
OMAP Mobile Processors	www.ti.com/omap
Wireless Connectivity	www.ti.com/wirelessconnectivity

Applications

Communications and Telecom	www.ti.com/communications
Computers and Peripherals	www.ti.com/computers
Consumer Electronics	www.ti.com/consumer-apps
Energy and Lighting	www.ti.com/energy
Industrial	www.ti.com/industrial
Medical	www.ti.com/medical
Security	www.ti.com/security
Space, Avionics and Defense	www.ti.com/space-avionics-defense
Transportation and Automotive	www.ti.com/automotive
Video and Imaging	www.ti.com/video

TI E2E Community Home Page

e2e.ti.com

Mailing Address: Texas Instruments, Post Office Box 655303, Dallas, Texas 75265
Copyright © 2011, Texas Instruments Incorporated







Looking for pricing, stock, or lifecycle information?

Click below to explore more details on WIN SOURCE:

 [View DS36276MX/NOPB on WIN SOURCE](#)

 [Texas Instruments](#) Information

Optimize Your Supply Chain with WIN SOURCE Solutions

-  Global Sourcing Solution
-  Obsolete Management
-  Cost Control Management
-  Shortage Management
-  Alternative Solution
-  Excess Inventory Management