

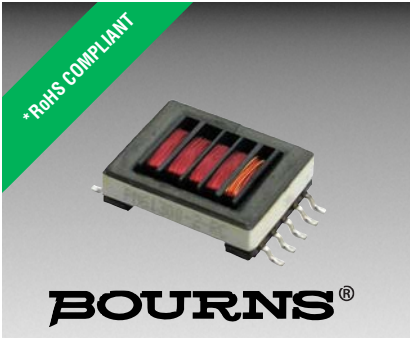

**THE DATASHEET OF  
PM61300-4-RC**





### Features

- Formerly J. W. Miller® model
- Power rating: 6 watts
- Operating frequency: 60 KHz ±25 %
- Tape and reel packaging
- RoHS compliant\*

This series is currently available, but not recommended for new designs.

### Applications

- LCD flat panel displays
- Notebook / palmtop computers
- Portable instruments
- Retail terminals

## PM61300 Series - SMD CCFL Transformer

### Electrical Specifications

Bourns Part No.	PRIMARY			SECONDARY			Turns Ratio
	L ±10 % @ 10 KHz (μH)	DCR Max. (Ω)	Voltage (V)	DCR Max. (Ω)	Voltage (V)	Irms (mA)	
PM61300-1-RC	44	0.61	25	132	1300	70	50
PM61300-2-RC	44	0.82	20	175	1300	70	67
PM61300-3-RC	27	1.10	15	175	1300	70	86
PM61300-4-RC	20	1.88	13	175	1300	70	100
PM61300-5-RC	20	2.34	10.5	290	1300	70	125

### Packaging Specifications

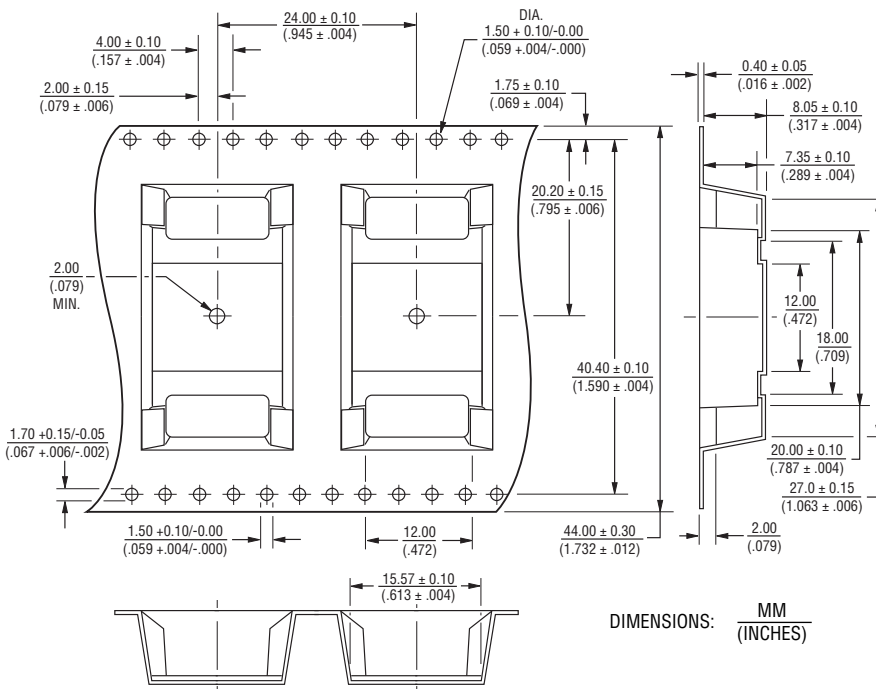

### General Specifications

Operating Temperature ..... -40 °C to +105 °C  
 Storage Temperature ..... -40 °C to +105 °C  
 Soldering ..... 245 °C, 5 seconds max.  
 Dielectric Strength ..... 1500 Vrms between windings

### Materials

Core ..... Ferrite  
 Wire ..... Polyester-coated copper  
 Terminal Coating ..... Sn  
 Packaging ..... 250 pcs. per 17-inch reel

### Product Dimensions

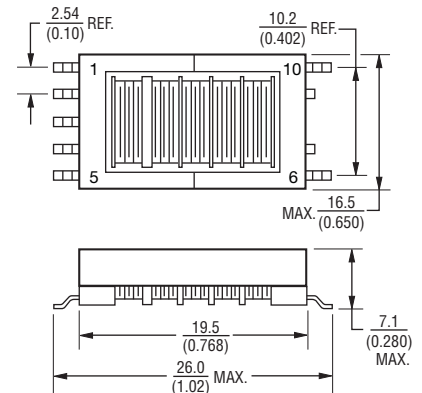

### Recommended Pad Layout

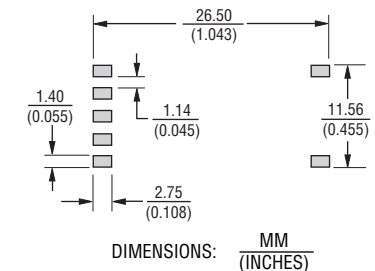

### Schematic

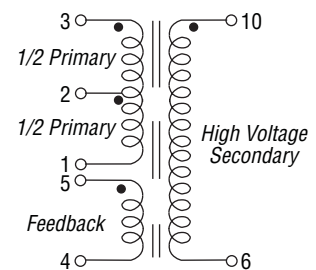



REV. 01/15

\*RoHS Directive 2002/95/EC Jan. 27, 2003 including annex and RoHS Recast 2011/65/EU June 8, 2011. Specifications are subject to change without notice.



The device characteristics and parameters in this data sheet can and do vary in different applications and actual device performance may vary over time. Users should verify actual device performance in their specific applications.

## Looking for pricing, stock, or lifecycle information?

Click below to explore more details on WIN SOURCE:

-  [View PM61300-4-RC on WIN SOURCE](#)
-  [Bourns Inc. Information](#)

## Optimize Your Supply Chain with WIN SOURCE Solutions

-  Global Sourcing Solution
-  Obsolete Management
-  Cost Control Management
-  Shortage Management
-  Alternative Solution
-  Excess Inventory Management