



**THE DATASHEET OF
MNR12E0ABJ103**



Chip resistor networks

MNR12 (1608×2 size)

●Features

- 1) Convex electrodes
Easy to check the fillet after soldering is finished.
- 2) Small, light, rectangular 2-chip network
Area ratio is 65% smaller than that of MNR32, while weight ratio has been cut 75%.
- 3) High-density mounting
Can be mounted even more densely than two 1608 chips (MCR03), and mounting costs are lower.
- 4) Compatible with a wide range of mounting equipment.
Squared corners make it excellent for mounting using image recognition devices.
- 5) ROHM resistors have approved ISO-9001 certification.
Design and specifications are subject to change without notice. Carefully check the specification sheet supplied with the product before using or ordering it.

●Ratings

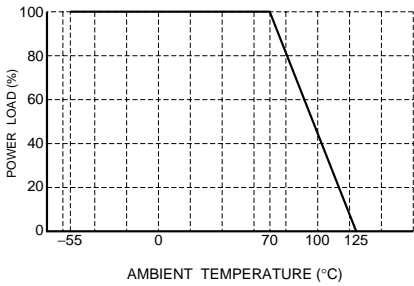
Item	Conditions	Specifications		
Rated power	<p>Power must be derated according to the power derating curve in Figure 1 when ambient temperature exceeds 70°C.</p>  <p style="text-align: center;">Fig.1</p>	0.063W (1 / 16W) at 70°C		
Rated voltage	<p>The voltage rating is calculated by the following equation. If the value obtained exceeds the limiting element voltage, the voltage rating is equal to the maximum operating voltage.</p> $E = \sqrt{P \times R}$ <p style="text-align: center;">E: Rated voltage (V) P: Rated power (W) R: Nominal resistance (Ω)</p>	<table border="1" style="width: 100%;"> <tr> <td style="width: 80%;">Limiting element voltage</td> <td>50V</td> </tr> </table>	Limiting element voltage	50V
Limiting element voltage	50V			
Nominal resistance	See Table 1.			
Operating temperature		-55°C~+125°C		

Resistors

Jumper type

Resistance	Max. 50mΩ
Rated current	1A
Operating temperature	-55°C~+125°C

Table 1

Resistance tolerance	Resistance range (Ω)	Resistance temperature coefficient (ppm / °C)
J (±5%)	10≤R≤1M (E24)	±200

•Before using components in circuits where they will be exposed to transients such as pulse loads (short-duration, high-level loads), be certain to evaluate the component in the mounted state. In addition, the reliability and performance of this component cannot be guaranteed if it is used with a steady state voltage that is greater than its rated voltage.

●Characteristics

Item	Guaranteed value		Test conditions (JIS C 5201-1)
	Resistor type	Jumper type	
Resistance	J : ±5%	Max. 50mΩ	JIS C 5201-1 4.5
Variation of resistance with temperature	See Table.1		JIS C 5201-1 4.8 Measurement : -55 / +25 / +125°C
Overload	± (2.0%+0.1Ω)	Max. 50mΩ	JIS C 5201-1 4.13 Rated voltage (current) ×2.5, 2s. Limiting Element Voltage×2 : 100V
Solderability	A new uniform coating of minimum of 95% of the surface being immersed and no soldering damage.		JIS C 5201-1 4.17 Rosin-Ethanol (25%WT) Soldering condition : 235±5°C Duration of immersion : 2.0±0.5s.
Resistance to soldering heat	± (1.0%+0.05Ω) No remarkable abnormality on the appearance.	Max. 50mΩ	JIS C 5201-1 4.18 Soldering condition : 260±5°C Duration of immersion : 10±1s.
Rapid change of temperature	± (1.0%+0.05Ω)	Max. 50mΩ	JIS C 5201-1 4.19 Test temp. : -55°C~+125°C 5cyc
Damp heat, steady state	± (3.0%+0.1Ω)	Max. 50mΩ	JIS C 5201-1 4.24 40°C, 93%RH Test time : 1,000h~1,048h
Endurance at 70°C	± (3.0%+0.1Ω)	Max. 50mΩ	JIS C 5201-1 4.25.1 Rated voltage (current), 70°C 1.5h : ON – 0.5h : OFF Test time : 1,000h~1,048h
Endurance	± (3.0%+0.1Ω)	Max. 50mΩ	JIS C 5201-1 4.25.3 125°C Test time : 1,000h~1,048h
Resistance to solvent	± (1.0%+0.05Ω)	Max. 50mΩ	JIS C 5201-1 4.29 23±5°C, Immersion cleaning, 5±0.5min. Solvent : 2-propanol
Bend strength of the end face plating	± (1.0%+0.05Ω) Without mechanical damage such as breaks.	Max. 50mΩ	JIS C 5201-1 4.33

Resistors

●External dimensions (Units : mm)

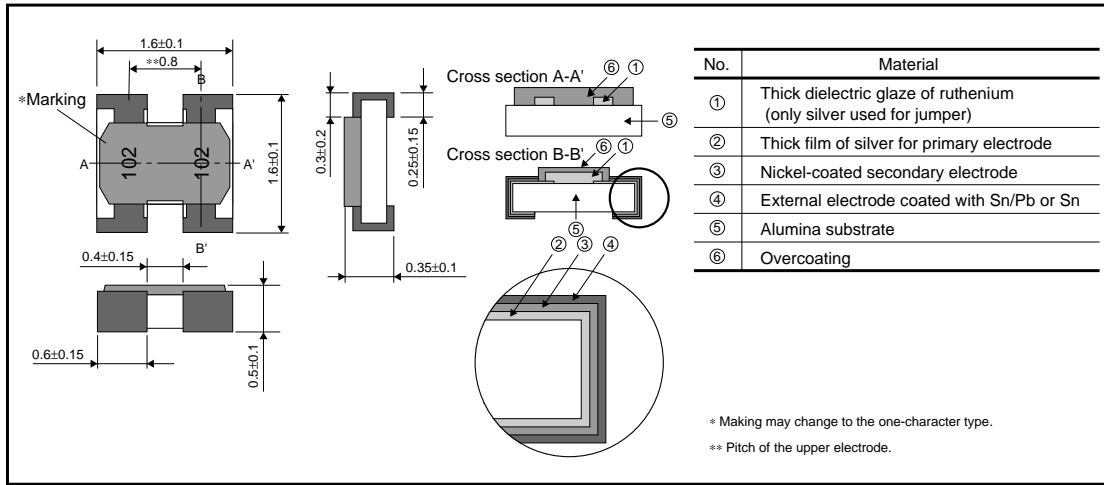

●Equivalent circuit

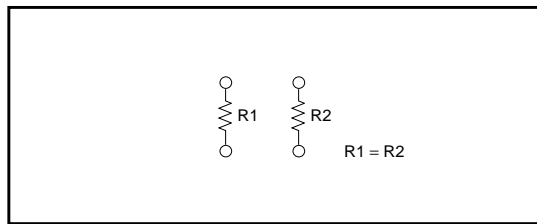

●Packaging

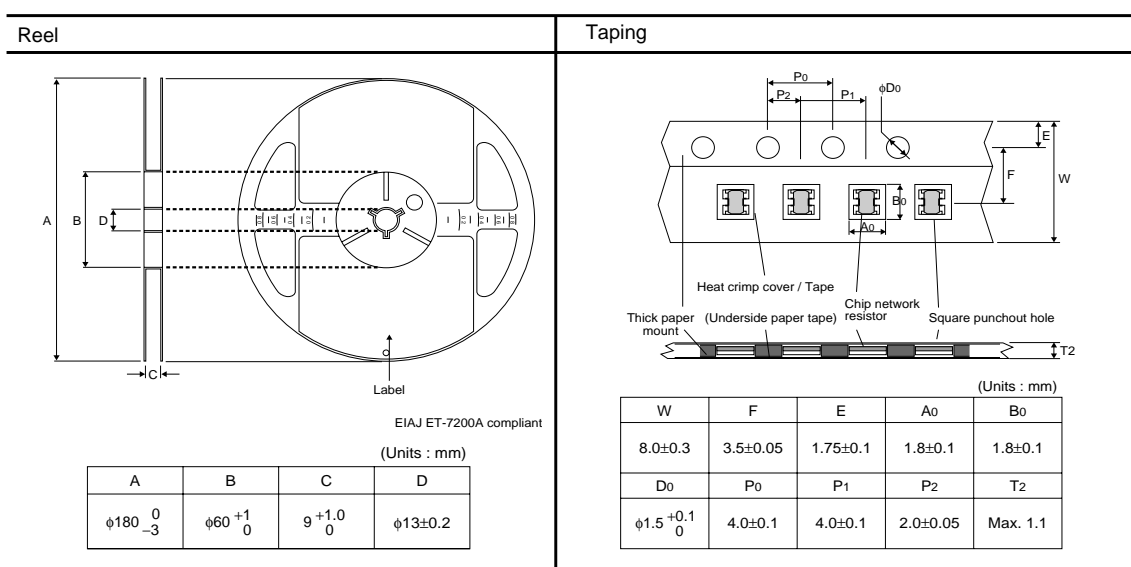

Resistors

●Product designation

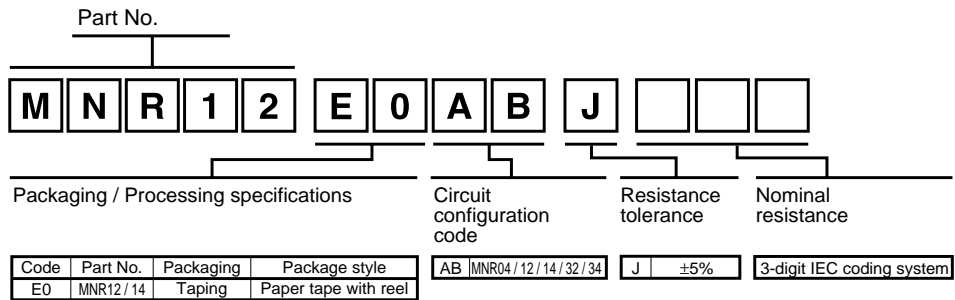

●Electrical characteristics

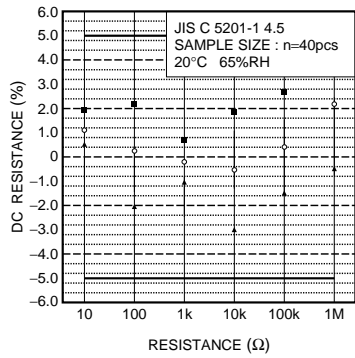

Fig.2 Resistance

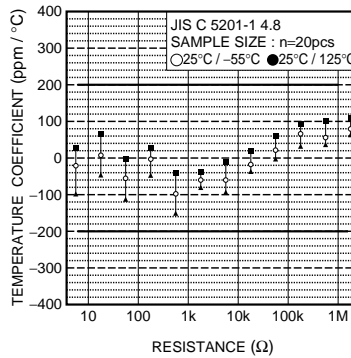

Fig.3 Variation resistance with temperature

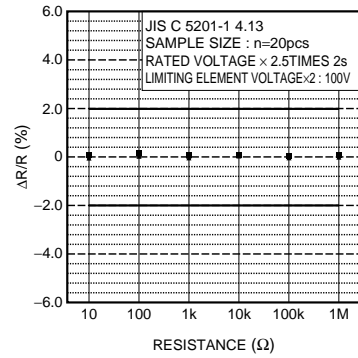

Fig.4 Overload

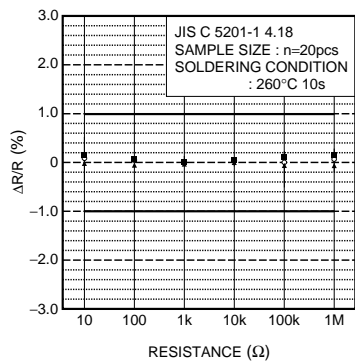

Fig.5 Resistance to soldering heat

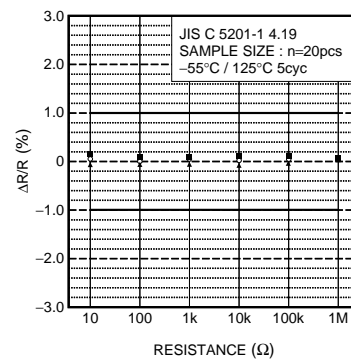

Fig.6 Rapid change of temperature

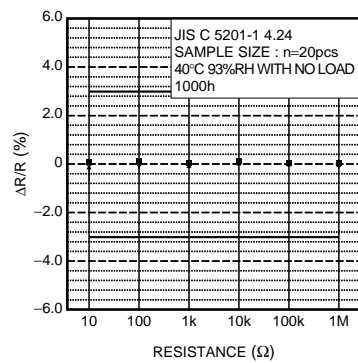

Fig.7 Damp heat, steady state

Resistors

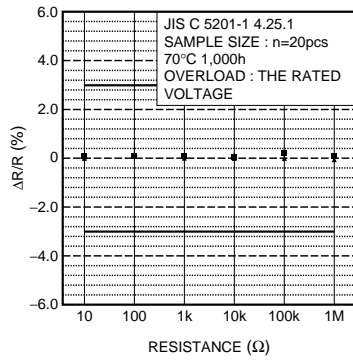

Fig.8 Endurance at 70°C

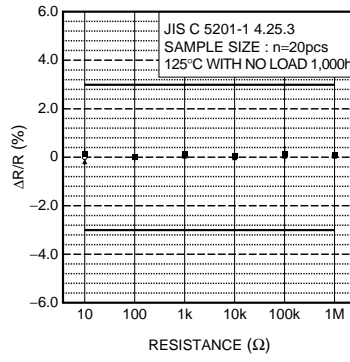

Fig.9 Endurance

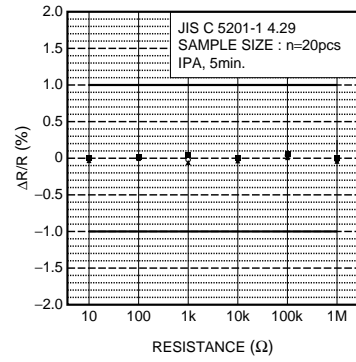



Fig.10 Resistance to solvents

Looking for pricing, stock, or lifecycle information?

Click below to explore more details on WIN SOURCE:

-  [View MNR12E0ABJ103](#) on WIN SOURCE
-  [Rohm Semiconductor](#) Information

Optimize Your Supply Chain with WIN SOURCE Solutions

-  Global Sourcing Solution
-  Obsolete Management
-  Cost Control Management
-  Shortage Management
-  Alternative Solution
-  Excess Inventory Management