

Finisar

Product Specification

Long-Reach DWDM SFP Transceiver

FWLF1631Rxx

PRODUCT FEATURES

- Up to 2.7 Gb/s bi-directional data links
- High launch power (+3dBm MIN)
- Hot-pluggable SFP footprint
- Temperature-stabilized DWDM-rated DFB laser transmitter
- 100GHz ITU Grid, C-Band
- Low dispersion DFB laser with up to 160km reach
- Extended operating range: -5°C to 70°C case temperature
- Wavelength controlled within ± 0.1 nm over life and temperature
- Extended link budget with APD receiver technology
- OC-48 LR-2 compliant



APPLICATIONS

- Amplified DWDM networks
- Bandwidth aggregation
- Ring topologies with fixed and reconfigurable OADM

Finisar's Dense Wavelength-Division Multiplexing (DWDM) transceivers offer DWDM transport with dramatically lower power and cost in a standard pluggable Small Form Factor Pluggable (SFP) package¹. The FWLF1631R is designed expressly for service providers deploying DWDM networking equipment in metropolitan access and core networks.

Basic digital diagnostic features for the FWLF1631R are implemented as described in Finisar Application Note AN-2030, "Digital Diagnostic Monitoring Interface for Optical Transceivers"⁴. Enhanced diagnostic features are available as described in the DWDM SFP MSA⁶.

Finisar

PRODUCT SELECTION (FWLF1631Rxx, where xx is channel number)

Product Code	Frequency (THz)	Center Wavelength (nm)
FWLF1631R17	191.7	1563.86
FWLF1631R18	191.8	1563.05
FWLF1631R19	191.9	1562.23
FWLF1631R20	192.0	1561.42
FWLF1631R21	192.1	1560.61
FWLF1631R22	192.2	1559.79
FWLF1631R23	192.3	1558.98
FWLF1631R24	192.4	1558.17
FWLF1631R25	192.5	1557.36
FWLF1631R26	192.6	1556.55
FWLF1631R27	192.7	1555.75
FWLF1631R28	192.8	1554.94
FWLF1631R29	192.9	1554.13
FWLF1631R30	193.0	1553.33
FWLF1631R31	193.1	1552.52
FWLF1631R32	193.2	1551.72
FWLF1631R33	193.3	1550.92
FWLF1631R34	193.4	1550.12
FWLF1631R35	193.5	1549.32
FWLF1631R36	193.6	1548.51
FWLF1631R37	193.7	1547.72
FWLF1631R38	193.8	1546.92
FWLF1631R39	193.9	1546.12
FWLF1631R40	194.0	1545.32
FWLF1631R41	194.1	1544.53
FWLF1631R42	194.2	1543.73
FWLF1631R43	194.3	1542.94
FWLF1631R44	194.4	1542.14
FWLF1631R45	194.5	1541.35
FWLF1631R46	194.6	1540.56
FWLF1631R47	194.7	1539.77
FWLF1631R48	194.8	1538.98
FWLF1631R49	194.9	1538.19
FWLF1631R50	195.0	1537.40
FWLF1631R51	195.1	1536.61
FWLF1631R52	195.2	1535.82
FWLF1631R53	195.3	1535.04
FWLF1631R54	195.4	1534.25
FWLF1631R55	195.5	1533.47
FWLF1631R56	195.6	1532.68
FWLF1631R57	195.7	1531.90
FWLF1631R58	195.8	1531.12
FWLF1631R59	195.9	1530.33
FWLF1631R60	196.0	1529.55
FWLF1631R61	196.1	1528.77

I. Pin Descriptions

Pin	Symbol	Name/Description	Ref.
1	V _{EET}	Transmitter Ground (Common with Receiver Ground)	1
2	T _{FAULT}	Transmitter Fault	
3	T _{DIS}	Transmitter Disable. Laser output disabled on high or open	2
4	MOD_DEF(2)	Module Definition 2. Data line for Serial ID	3
5	MOD_DEF(1)	Module Definition 1. Clock line for Serial ID	3
6	MOD_DEF(0)	Module Definition 0. Grounded within the module	3
7	Rate Select	No connection required	4
8	LOS	Loss of Signal indication. Logic 0 indicates normal operation	5
9	V _{EER}	Receiver Ground (Common with Transmitter Ground)	1
10	V _{EER}	Receiver Ground (Common with Transmitter Ground)	1
11	V _{EER}	Receiver Ground (Common with Transmitter Ground)	1
12	RD-	Receiver Inverted DATA out. AC Coupled	
13	RD+	Receiver Non-inverted DATA out. AC Coupled	
14	V _{EER}	Receiver Ground (Common with Transmitter Ground)	1
15	V _{CCR}	Receiver Power Supply	
16	V _{CCT}	Transmitter Power Supply	
17	V _{EET}	Transmitter Ground (Common with Receiver Ground)	1
18	TD+	Transmitter Non-Inverted DATA in. 100 ohm termination between TD+ and TD-, AC Coupled thereafter	
19	TD-	Transmitter Inverted DATA in. See TD+	
20	V _{EET}	Transmitter Ground (Common with Receiver Ground)	1

Notes:

- Circuit ground is internally isolated from chassis ground.**
- Laser output disabled on T_{DIS} >2.0V or open, enabled on T_{DIS} <0.8V.
- Should be pulled up with 4.7k – 10kohms on host board to a voltage between 2.0V and 5.5V. MOD_DEF(0) pulls line low to indicate module is plugged in.
- Receiver achieves multi-rate operation without active control.
- LOS is open collector output. Should be pulled up with 4.7k – 10kohms on host board to a voltage between 2.0V and 5.5V. Logic 0 indicates normal operation; logic 1 indicates loss of signal.

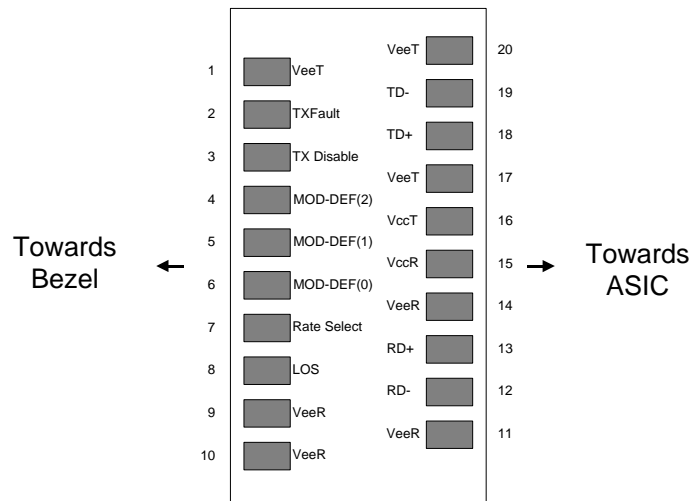
**Diagram of Host Board Connector Block Pin Numbers and Names**

II. Absolute Maximum Ratings

Parameter	Symbol	Min	Typ	Max	Unit
Maximum Supply Voltage	V _{CC}	-0.5		4.7	V
Storage Temperature	T _S	-10		85	°C
Case Operating Temperature	T _{OP}	-5		70	°C

III. Electrical Characteristics (T_{OP} = -5 to 70 °C, V_{CC} = 3.13 to 3.50 Volts)

Parameter	Symbol	Min	Typ	Max	Unit	Ref.
Supply Voltage	V _{CC}	3.13	3.30	3.50	V	
Supply Current	I _{CC}			380	mA	
Inrush Current	I _{surge}			I _{CC} +30	mA	
Maximum Power	P _{max}			1.25	W	
TRANSMITTER						
Input differential impedance	R _{in}		100		Ω	1
Single ended data input swing	V _{in,pp}	250		1200	mV	
Transmit Disable Voltage	V _D	V _{CC} – 1.3		V _{CC}	V	
Transmit Enable Voltage	V _{EN}	V _{EE}		V _{EE} + 0.8	V	2
RECEIVER						
Single ended data output swing	V _{out,pp}	175		1000	mV	3
Data output rise time	t _r			150	ps	4
Data output fall time	t _f			150	ps	4
LOS Fault	V _{LOS fault}	V _{CC} – 0.5		V _{CC} _{HOST}	V	5
LOS Normal	V _{LOS norm}	V _{EE}		V _{EE} +0.5	V	5
Power Supply Rejection	PSR	100			mVpp	6

Notes:

1. Connected directly to TX data input pins. AC coupled thereafter.
2. Or open circuit.
3. Into 100 ohms differential termination.
4. 20 – 80 %
5. Loss of signal (LOS) is LVTTTL. Logic 0 indicates normal operation; logic 1 indicates no signal detected.
6. Receiver sensitivity is compliant with power supply sinusoidal modulation of 20 Hz to 1.5 MHz up to specified value applied through the recommended power supply filtering network.

IV. Low Speed Signals

Parameter	Symbol	Min	Typ	Max	Units	Notes/Conditions
RX_LOS Assert Level		-42	-36		dBm	
RX_LOS De-assert Level			-34	-32	dBm	
RX_LOS Hysteresis		0.5	2		dB	
RX_LOS Assert Delay	t_loss_on			100	μsec	From detection of loss of signal to assertion of RX_LOS
RX_LOS Negate Delay	t_loss_off			100	μsec	From detection of presence of signal to negation of RX_LOS
TX_DISABLE Assert Time	t_off			10	μsec	Rising edge of TX_DISABLE to fall of output signal below 10% of nominal
TX_DISABLE Negate Time	t_on			1000	μsec	Falling edge of TX_DISABLE to rise of output signal above 90% of nominal. Time indicated is under steady-state temperature conditions.
TX_DISABLE Reset Time	t_reset	10			μsec	TX_DISABLE HIGH before TX_DISABLE set LOW
TX_FAULT Assert		-0.2		+0.2	nm	TX_Fault will assert before the device is outside of specified wavelength range

V. Optical Parameters

Parameter	Symbol	Min	Typ	Max	Units	Notes/Conditions
TRANSMITTER CHARACTERISTICS						
Center Wavelength Spacing			100		GHz	Corresponds to approximately 0.8 nm
Modulated Spectral Width	$\Delta\lambda_{20}$		0.2	0.3	nm	Full width, -20dB from max. See note 3
Transmitter Center Wavelength – End of Life	λ_c	X - 100	X	X + 100	pm	X = specified center wavelength
Transmitter Center Wavelength – Start of Life	λ_c	Y - 25	Y	Y + 25	pm	Y = specified center wavelength
Side Mode Suppression Ratio (SMSR)	SMSR	30			dB	Modulated
Optical Rise/Fall Time	t_r / t_f			160	ps	Unfiltered, 80% -20%
Transmitter Optical Output Power	P_{out}	+3		+7	dBm	Average power coupled into single mode fiber
Transmitter Extinction Ratio	OMI	8.2			dB	
Transmitter Eye Opening		10			%	OC-48 eye mask margin
Transmitter Jitter Generation				75	mUI	Parameters per GR-253 ² section 5.6 for OC-48 B
Tolerable Back Reflection	BR			-14	dB	See note 4
Relative Intensity Noise	RIN			-120	dB/Hz	
Dispersion Power Penalty at 3200ps/nm	DPP			3.0	dB	See Note 5
RECEIVER CHARACTERISTICS						
Optical Input Wavelength	P_{in}	1520		1570	nm	
Receiver Jitter Generation				75	mUI	Parameters per GR-253 ² section 5.6 for OC-48 B
Optical Input Power (BER < 10 ⁻¹²)	P_{in}	-28		-9	dBm	2.5 Gb/s w/ PRBS 2 ²³ -1
Optical Input Power – Receiver Damage Threshold				+6	dBm	
Receiver Reflectance	R_{RX}			-27	dB	
Dispersion Noise Penalty at 3200ps/nm	DNP			3.0	dB	See Note 6

Notes:

- Parameters are specified over temperature and voltage, at end of life unless otherwise noted.
- All parameters are measured on a Finisar SFP Evaluation Card unless otherwise noted.
- For accurate $\Delta\lambda_{20}$ measurements, an OSA with a resolution band width of ≤ 20 pm is recommended.
- Tolerable back reflection is the max back reflection level at which the power penalty will be <1dB.
- Dispersion power penalty is measured in loop back with OSNR set to 28 dB. Data rate and pattern used same as specified for Optical Input Power. Dispersion power penalty is the difference in Rx power at a BER of 10⁻¹² for 0ps/nm and 3200ps/nm.
- Dispersion noise penalty is measured in loop back with Rx power set between -9dBm and -22dBm. Data rate and pattern used same as specified for Optical Input Power. Dispersion noise penalty is the difference in OSNR at a BER of 10⁻¹² for 0ps/nm and 3200ps/nm

VI. Wavelength Stabilization

The laser transmitter will not be turned on until its temperature is adjusted to ensure operation within the specified channel ($X \pm 300\text{pm}$). This temperature stabilization time is dependent on the ambient temperature conditions, but will typically occur within 5 seconds of powering the device. The module will transmit within the specified wavelength tolerance ($X \pm 100\text{pm}$) within 10 ms of transmitter operation.

VII. General Specifications

Parameter	Symbol	Min	Typ	Max	Units	Notes/Conditions
Data Rate	BR	0.155		2.7	Gb/sec	SONET OC-48 compliant SONET OC-3/12 compatible
Total Link Budget		31	34		dB	@ 2.5 Gb/s, BER $<10^{-12}$ w/ PRBS $2^{23}-1$. See Note 1

Note 1: Total link budget is defined as $P_{\text{out}} - P_{\text{in}}$ – typical connector losses.

VIII. Environmental Specifications

Parameter	Symbol	Min	Typ	Max	Units	Notes/Conditions
Operating Temp	T_{op}	-5		70	°C	Case temperature measured on top-side of device
Storage Temp	T_{sto}	-40		85	°C	Ambient temperature
Eye Safety						CDRH and IEC-825 Class 1 Laser Product. See Note 1

Note 1: Complies with FDA performance standards for laser products except for deviations pursuant to Laser Notice No. 50, dated July 26, 2001.

IX. Serial Communication Protocol

All Finisar SFPs support the 2-wire serial communication protocol to provide module ID information as outlined in the SFP MSA¹. These SFPs use an Atmel AT24C01A 128 byte E²PROM with an address of A0h. For details on interfacing with the E²PROM, see the Atmel data sheet titled “AT24C01A/02/04/08/16 2-Wire Serial CMOS E²PROM.”³

Finisar SFPs also support diagnostic features as described in Finisar Applications Note AN-2030⁴ and SFF-8472⁵, “Digital Diagnostic Monitoring Interface for Optical Transceivers”. A controller IC that monitors system parameters such as laser current, module temperature, transmitter power, and received power is accessible at address A2H. In addition, Finisar’s DWDM SFPs provide extended set of ID information and diagnostic features as described in the DWDM SFP MSA⁶.

I²C clock speed, digital diagnostic accuracy and digital diagnostic range can be found in the table below. Values in the table represent the worst-case values over temperature, voltage, and life.

Parameter	Symbol	Min	Typ	Max	Units	Notes/Conditions
I ² C Clock Speed		0		100,000	Hz	Bus can be driven blind
Accuracy						
Transceiver Case Temperature	DD _{Temperature}	-10		+10	°C	Measured on the top-side of the module case
Transceiver Supply Voltage	DD _{Voltage}	-3		+3	%	
Tx Bias Current	DD _{Bias}	-10		+10	%	
Tx Output Power	DD _{TxPower}	-2		+2	dB	
Received Average Power	DD _{RxPower}	-2		+2	dB	
Range						
Transceiver Case Temperature	DD _{Temperature}	-40		85	°C	
Transceiver Supply Voltage	DD _{Voltage}	3.0		4.0	V	
Tx Bias Current	DD _{Bias}	0		90	mA	
Tx Output Power	DD _{TxPower}	-5		+10	dBm	
Received Average Power	DD _{RxPower}	-30		-7	dBm	

X. Mechanical Specifications

Finisar's Multi-rate DWDM Small Form Factor Pluggable (SFP) transceivers are compatible with the dimensions defined by the DWDM SFP Multi-Sourcing Agreement (MSA)⁶.

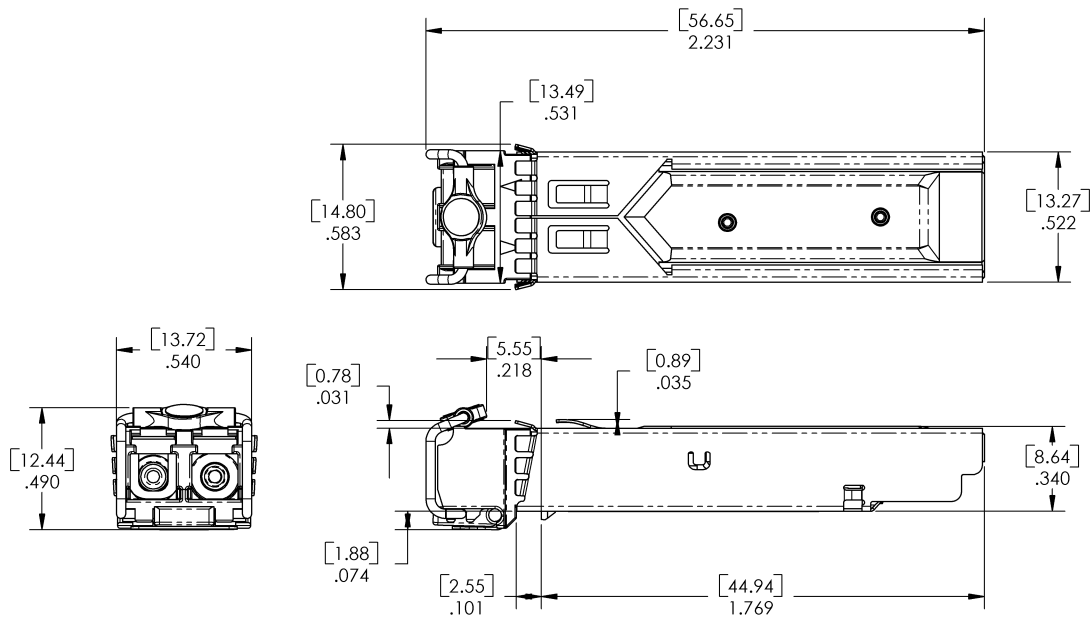

Figure 1. DWDM SFP Outline Drawing (units in inches [mm])

XI. Ordering Information

Part Number	Description
FWLF1631Rxx	DWDM SFP with APD Receiver xx = channel number (see product selection on page 2)

XII. References

1. Small Form Factor Pluggable (SFP) Transceiver Multi-Source Agreement (MSA), September 2000. Documentation is currently available from Finisar upon request.
2. “SONET Transport Systems: Common Generic Criteria”, Telcordia Technologies, GR-253-CORE, Issue 3, September 2000.
3. “AT24C01A/02/04/08/16 2-Wire Serial CMOS E²PROM”, Atmel Corporation.
www.Atmel.com.
4. “Application Note AN-2030: Digital Diagnostic Monitoring Interface for Optical Transceivers”, Finisar Corporation, April 2002.
5. “Digital Diagnostic Monitoring Interface For Optical Transceivers Rev 9.3”. SFF Document No. SFF-8472.
6. Specifications for DWDM SFP Transceiver Draft 1.0.October 21 2005.
Documentation is available from Finisar upon request.

For More Information:

Finisar Corporation
1308 Moffett Park Drive
Sunnyvale, CA 94089-1133
Tel. (408) 548-1000
Fax (408) 541-6138
sales@finisar.com
www.finisar.com

Looking for pricing, stock, or lifecycle information?

Click below to explore more details on WIN SOURCE:

 [View FWLF1631R24 on WIN SOURCE](#)

 [Finisar Corporation](#) Information

Optimize Your Supply Chain with WIN SOURCE Solutions

-  Global Sourcing Solution
-  Obsolete Management
-  Cost Control Management
-  Shortage Management
-  Alternative Solution
-  Excess Inventory Management