

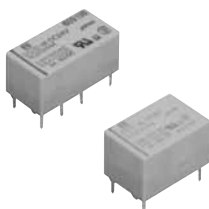

! Partly to Be Discontinued:
2 Form C type
(Standard, Reverse polarity type)
Last time buy: March 31, 2015

**Long seller backed
by product variety and
high reliability**

DS RELAYS



FEATURES

- 1. Breakthrough height of 9.8 mm .386 inch beats the 10 mm .394 inch limit**
1c and 2c all have the same height (9.8 mm .386 inch). The width of the relay is also the same (9.9 mm .390 inch). Since the only size variable is the length, the shared form makes mounting on printed printing wiring boards easy.
- 2. Suitable for use in difficult environments**
Epoxy resin seals the parts and cut off the external atmosphere, thus enabling use in difficult environments.
- 3. Can be used with automatic solder and automatic wash systems**
Automatic soldering and automatic washing can be carried out once the parts are mounted on PC boards.
- 4. Gold-clad twin contacts ensure high reliability**
Highly stable gold cladding on the contacts ensures that contact resistance changes little over time. Furthermore, the use of twin contacts, a configuration that performs with superior contact reliability, ensures extremely low contact failure rates even under low level loads.

- 5. Polarized magnetic circuits realize resistance to shock and vibration**
High-performance polarized magnetic circuits that utilize the energy of permanent magnets have made it possible to create relays with strong resistance to shock and vibration.
- 6. DIL terminal array enables use of IC sockets**
- 7. Widening scope of application with multicontact latching**
In addition to single side stable types, you can take advantage of the memory of functions of convenient 1 coil or 2 coil latching relays.

TYPICAL APPLICATIONS

Besides telecommunications, measuring devices, office equipment, computers and related equipment, DS relays are also recommended for a broad range of applications including business devices, audio systems, and industrial equipment.

Compliance with RoHS Directive

ORDERING INFORMATION

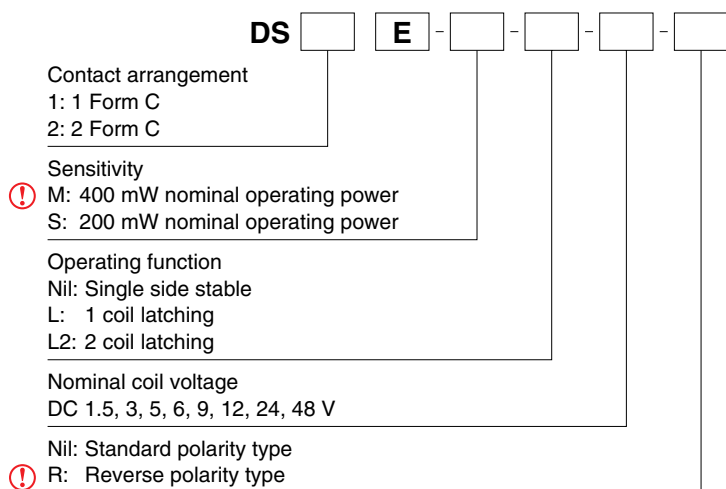

Note: 1 coil latching type are manufactured by lot upon receipt of order.

! Reverse polarity types available (add suffix-R)

TYPES

1. Standard type

| Contact arrangement | Nominal coil voltage | Single side stable type | 2 coil latching type |
|---------------------|----------------------|-------------------------|----------------------|
| | | Part No. | Part No. |
| 1 Form C | 1.5V DC | DS1E-M-DC1.5V | DS1E-ML2-DC1.5V |
| | 3V DC | DS1E-M-DC3V | DS1E-ML2-DC3V |
| | 5V DC | DS1E-M-DC5V | DS1E-ML2-DC5V |
| | 6V DC | DS1E-M-DC6V | DS1E-ML2-DC6V |
| | 9V DC | DS1E-M-DC9V | DS1E-ML2-DC9V |
| | 12V DC | DS1E-M-DC12V | DS1E-ML2-DC12V |
| | 24V DC | DS1E-M-DC24V | DS1E-ML2-DC24V |
| 2 Form C | 3V DC | DS2E-M-DC3V | DS2E-ML2-DC3V |
| | 5V DC | DS2E-M-DC5V | DS2E-ML2-DC5V |
| | 6V DC | DS2E-M-DC6V | DS2E-ML2-DC6V |
| | 9V DC | DS2E-M-DC9V | DS2E-ML2-DC9V |
| | 12V DC | DS2E-M-DC12V | DS2E-ML2-DC12V |
| | 24V DC | DS2E-M-DC24V | DS2E-ML2-DC24V |
| | 48V DC | DS2E-M-DC48V | DS2E-ML2-DC48V |

Standard packing: Tube: 50 pcs.; Case: 500 pcs.

2. High sensitivity type

| Contact arrangement | Nominal coil voltage | Single side stable type | 2 coil latching type |
|---------------------|----------------------|-------------------------|----------------------|
| | | Part No. | Part No. |
| 1 Form C | 1.5V DC | DS1E-S-DC1.5V | DS1E-SL2-DC1.5V |
| | 3V DC | DS1E-S-DC3V | DS1E-SL2-DC3V |
| | 5V DC | DS1E-S-DC5V | DS1E-SL2-DC5V |
| | 6V DC | DS1E-S-DC6V | DS1E-SL2-DC6V |
| | 9V DC | DS1E-S-DC9V | DS1E-SL2-DC9V |
| | 12V DC | DS1E-S-DC12V | DS1E-SL2-DC12V |
| | 24V DC | DS1E-S-DC24V | DS1E-SL2-DC24V |
| 2 Form C | 3V DC | DS2E-S-DC3V | DS2E-SL2-DC3V |
| | 5V DC | DS2E-S-DC5V | DS2E-SL2-DC5V |
| | 6V DC | DS2E-S-DC6V | DS2E-SL2-DC6V |
| | 9V DC | DS2E-S-DC9V | DS2E-SL2-DC9V |
| | 12V DC | DS2E-S-DC12V | DS2E-SL2-DC12V |
| | 24V DC | DS2E-S-DC24V | DS2E-SL2-DC24V |
| | 48V DC | DS2E-S-DC48V | DS2E-SL2-DC48V |

Standard packing: Tube: 50 pcs.; Case: 500 pcs.

Note: Reverse polarity types available (add suffix-R) 

RATING

1. Coil data

1) Single side stable type

| Type | Nominal coil voltage | Pick-up voltage (at 20°C 68°F) | Drop-out voltage (at 20°C 68°F) | Nominal operating current [$\pm 10\%$] (at 20°C 68°F) | Coil resistance [$\pm 10\%$] (at 20°C 68°F) | Nominal operating power | Max. applied voltage (at 50°C 122°F) |
|---------------------------|----------------------|--|---|---|---|-------------------------|--|
| Standard (M) type | 1.5V DC | 70%V or less of nominal voltage (Initial) | 10%V or more of nominal voltage (Initial) | 266.7mA | 5.63Ω | 400mW | 1 Form C: 120%V of nominal voltage 2 Form C: 150%V of nominal voltage |
| | 3V DC | | | 133.3mA | 22.5Ω | | |
| | 5V DC | | | 80.0mA | 62.5Ω | | |
| | 6V DC | | | 66.7mA | 90Ω | | |
| | 9V DC | | | 44.4mA | 203Ω | | |
| | 12V DC | | | 33.3mA | 360Ω | | |
| | 24V DC | | | 16.7mA | 1,440Ω | | |
| High sensitivity (S) type | 1.5V DC | 1 Form C: 80%V or less of nominal voltage 2 Form C: 70%V or less of nominal voltage (Initial) | 10%V or more of nominal voltage (Initial) | 133.3mA | 11.3Ω | 200mW | 1 Form C: 160%V of nominal voltage 2 Form C: 200%V of nominal voltage |
| | 3V DC | | | 66.7mA | 45Ω | | |
| | 5V DC | | | 40.0mA | 125Ω | | |
| | 6V DC | | | 33.3mA | 180Ω | | |
| | 9V DC | | | 22.2mA | 405Ω | | |
| | 12V DC | | | 16.7mA | 720Ω | | |
| | 24V DC | | | 8.3mA | 2,880Ω | | |
| 48V DC | 4.2mA | 11,520Ω | | | | | |

2) 2 coil latching type

| Type | Nominal coil voltage | Set voltage (at 20°C 68°F) | Reset voltage (at 20°C 68°F) | Nominal operating current [±10%] (at 20°C 68°F) | | Coil resistance [±10%] (at 20°C 68°F) | | Nominal operating power | | Max. applied voltage (at 50°C 122°F) |
|---------------------------|----------------------|---|---|---|------------|---------------------------------------|------------|-------------------------|------------|--|
| | | | | Set coil | Reset coil | Set coil | Reset coil | Set coil | Reset coil | |
| Standard (M) type | 1.5V DC | 70%V or less of nominal voltage (Initial) | 70%V or less of nominal voltage (Initial) | 240mA | 240mA | 6.25Ω | 6.25Ω | 360mW | 360mW | 1 Form C: 120%V of nominal voltage 2 Form C: 150%V of nominal voltage |
| | 3V DC | | | 120mA | 120mA | 25Ω | 25Ω | | | |
| | 5V DC | | | 72mA | 72mA | 69.4Ω | 69.4Ω | | | |
| | 6V DC | | | 60mA | 60mA | 100Ω | 100Ω | | | |
| | 9V DC | | | 40mA | 40mA | 225Ω | 225Ω | | | |
| | 12V DC | | | 30mA | 30mA | 400Ω | 400Ω | | | |
| | 24V DC | | | 15mA | 15mA | 1,600Ω | 1,600Ω | | | |
| | 48V DC | | | 7.5mA | 7.5mA | 6,400Ω | 6,400Ω | | | |
| High sensitivity (S) type | 1.5V DC | 1 Form C: 80%V or less of nominal voltage | 1 Form C: 80%V or less of nominal voltage | 120mA | 120mA | 12.5Ω | 12.5Ω | 180mW | 180mW | 1 Form C: 160%V of nominal voltage 2 Form C: 200%V of nominal voltage |
| | 3V DC | | | 60mA | 60mA | 50Ω | 50Ω | | | |
| | 5V DC | | | 36mA | 36mA | 139Ω | 139Ω | | | |
| | 6V DC | | | 30mA | 30mA | 200Ω | 200Ω | | | |
| | 9V DC | 20mA | 20mA | 450Ω | 450Ω | | | | | |
| | 12V DC | 15mA | 15mA | 800Ω | 800Ω | | | | | |
| | 24V DC | 7.5mA | 7.5mA | 3,200Ω | 3,200Ω | | | | | |
| | 48V DC | 3.75mA | 3.75mA | 12,800Ω | 12,800Ω | | | | | |

2. Specifications

| Characteristics | Item | Specifications | |
|----------------------------|---|---|--|
| Contact | Arrangement | 1 Form C 2 Form C | |
| | Initial contact resistance, max. | Max. 50 mΩ (By voltage drop 6 V DC 1A) | |
| | Contact material | Ag+Au clad | |
| Rating | Nominal switching capacity | 2 A 30 V DC (resistive load) | |
| | Max. switching power | 60 W, 125 VA (resistive load) | |
| | Max. switching voltage | 220 V DC, 250 V AC | |
| | Max. carrying current | 3 A | |
| | Min. switching capacity (Reference value)*1 | 10μA 10m V DC | |
| | Nominal operating power | Single side stable (M type: 400 mW, S type: 200 mW); latching (M type: 360 mW, S type: 180 mW) | |
| Electrical characteristics | Insulation resistance (Initial) | Min. 100MΩ (at 500V DC) Measurement at same location as "Initial breakdown voltage" section. | |
| | Breakdown voltage (Initial) | Between open contacts | 1,000 Vrms for 1min. (500 Vrms for 1min: 1 Form C high sensitivity type) (Detection current: 10mA.) |
| | | Between contact and coil | 1,500 Vrms for 1min. (1,000 Vrms for 1min: 1 Form C high sensitivity type) (Detection current: 10mA.) |
| | Temperature rise | Max. 65°C (By resistive method, nominal coil voltage applied to the coil, contact carrying current: 2A.) | |
| | Operate time [Set time] (at 20°C 68°F) | Max. 10 ms [10 ms] (Nominal coil voltage applied to the coil, excluding contact bounce time.) | |
| | Release time [Reset time] (at 20°C 68°F) | Max. 5 ms [10 ms] (Nominal coil voltage applied to the coil, excluding contact bounce time.) (without diode) | |
| Mechanical characteristics | Shock resistance | Functional*2 | Min. 490 m/s ² Min. 490 m/s ² |
| | | Destructive | Min. 980 m/s ² (Half-wave pulse of sine wave: 6 ms.) |
| | Vibration resistance | Functional | 10 to 55 Hz at double amplitude of 3.3 mm (Detection time: 10μs.) |
| | | Destructive | 10 to 55 Hz at double amplitude of 5 mm |
| Expected life | Mechanical | Min. 10 ⁸ (10 ⁷ : 1 Form C latching type) (at 600 cpm) | |
| | Electrical | Min. 5×10 ⁵ rated load (at 60 cpm) | |
| Conditions | Conditions for operation, transport and storage*3 | Ambient temperature: -40°C to +70°C -40°F to +158°F Humidity: 5 to 85% R.H. (Not freezing and condensing at low temperature) | |
| | Max. operating speed (at rated load) | 60 cpm | |
| Unit weight | | Approx. 3 g .11 oz Approx. 4g .14oz | |

Notes: *1 This value can change due to the switching frequency, environmental conditions, and desired reliability level, therefore it is recommended to check this with the actual load. (TX/TX-S/TX-D relay AgPd contact type are available for low level load switching [10V DC, 10mA max. level])

*2 Half-wave pulse of sine wave: 11ms; detection time: 10μs

*3 Refer to 6. Conditions for operation, transport and storage mentioned in AMBIENT ENVIRONMENT (Page 24).

REFERENCE DATA

1. Maximum switching capacity

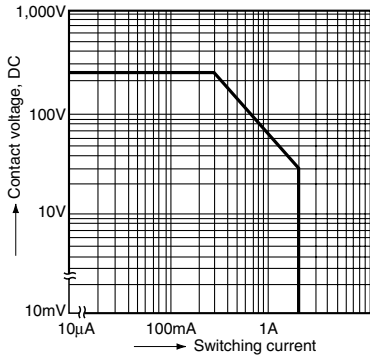

2. Life curve (Resistive load)

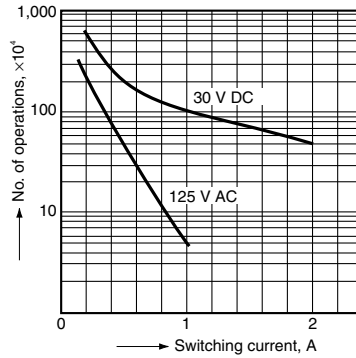

3. Contact reliability for AC loads

Tested sample: DS2E-M-DC24V 10 pcs.
Operating speed: 20 cpm.
Detection level: 200 mΩ

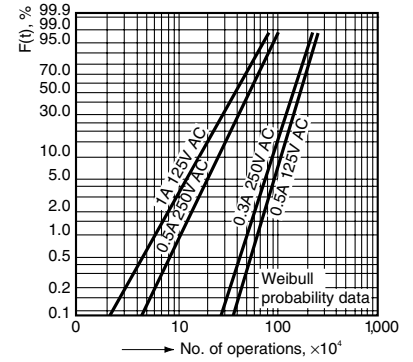

4-(1). Coil temperature rise

(2 Form C single side stable type)

Tested sample: DS2E-M-DC12V

Point measured: Inside the coil

Ambient temperature: 18° to 19°C 64° to 66°F

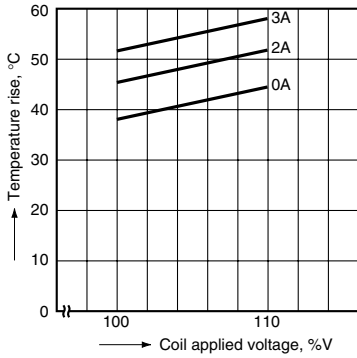

4-(2). Coil temperature rise

(2 Form C 2 coil latching type)

Tested sample: DS2E-ML2-DC12V

Point measured: Inside the coil

Ambient temperature: 20° to 21°C 68° to 70°F

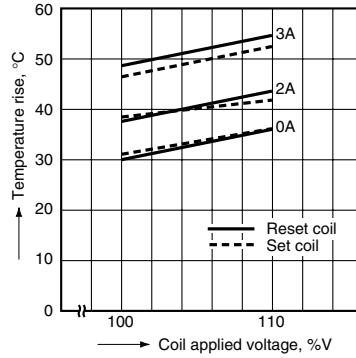

5. Operate and release time characteristics

(2 Form C single side stable type)

Test condition: Without diode connected to coil in parallel

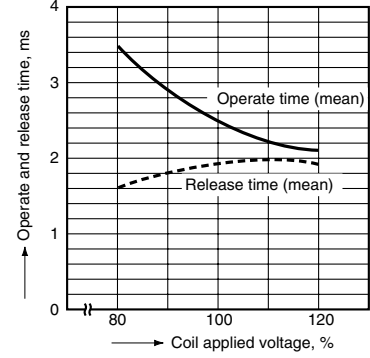

6-(1). Influence of adjacent mounting

(1 Form C)

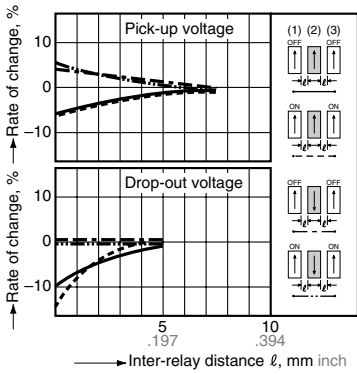

6-(2). Influence of adjacent mounting

(2 Form C)

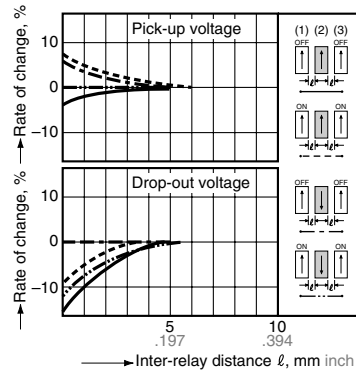

DIMENSIONS (mm inch)

The CAD data of the products with a **CAD Data** mark can be downloaded from: <http://panasonic-electric-works.net/ac>

DS (1 Form C)

Single side stable, 2 coil latching

CAD Data

External dimensions

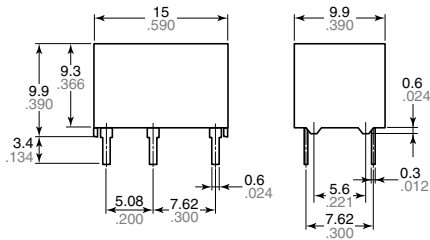

General tolerance: $\pm 0.3 \pm 0.012$

PC board pattern (Bottom view)

Single side stable

2 coil latching

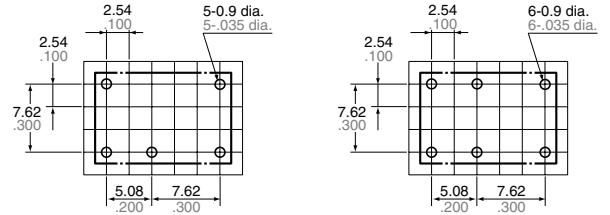

Schematic (Bottom view)

Single side stable

2 coil latching



(Deenergized condition)

(Reset condition)

Tolerance: $\pm 0.1 \pm 0.004$

Note: External dimensions of 1 coil latching types are same as single side stable type.

DS (2 Form C)

Single side stable

CAD Data

External dimensions

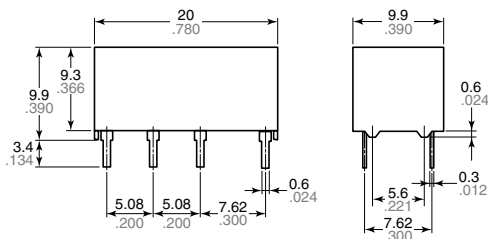

General tolerance: $\pm 0.3 \pm 0.012$

PC board pattern (Bottom view)

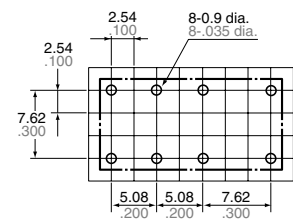

Schematic (Bottom view)

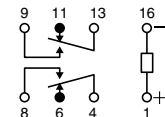

(Deenergized condition)

Tolerance: $\pm 0.1 \pm 0.004$

Note: External dimensions of 1 coil latching types are same as single side stable type.

DS (2 Form C)

2 coil latching

CAD Data

External dimensions

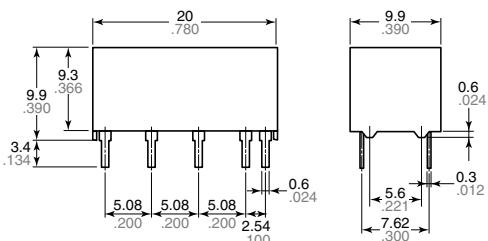

General tolerance: $\pm 0.3 \pm 0.012$

PC board pattern (Bottom view)

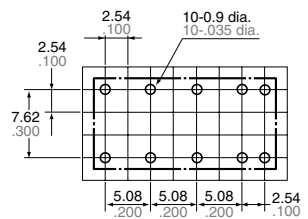

Schematic (Bottom view)

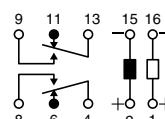

(Reset condition)

Tolerance: $\pm 0.1 \pm 0.004$



NOTES



1. Coil connection

When connecting coils, refer to the wiring diagram to prevent mis-operation or malfunction.

For general cautions for use, please refer to the “Cautions for use of Signal Relays” or “General Application Guidelines”.

Looking for pricing, stock, or lifecycle information?

Click below to explore more details on WIN SOURCE:

-  [View DS2E-M-DC12V on WIN SOURCE](#)
-  [Panasonic Information](#)

Optimize Your Supply Chain with WIN SOURCE Solutions

-  Global Sourcing Solution
-  Obsolete Management
-  Cost Control Management
-  Shortage Management
-  Alternative Solution
-  Excess Inventory Management