



**THE DATASHEET OF
ABM8AIG-16.384MHZ-12-2Z-T3**





ABM8AIG



3.2 x 2.5 x 0.8 mm
RoHS/RoHS II Compliant
 MSL = N/A: Not Applicable

Features

- AEC-Q200 Qualified
- Automotive Grade 1: -40°C to +125°C
- Automotive Grade 0: -40°C to +150°C (Available Upon Request)
- TS16949 Production Line Certified
- PPAP Available Upon Request
- Hermetically Seam-sealed Ceramic Package
- RoHS/RoHS II Compliant and Pb free

Applications

- Infotainment Systems
- Keyless Entry & Startup
- GPS & Navigation
- Comfort control
- ADAS (Advanced Driver Assistance Systems)
- Vehicle to Vehicle Communication
- LiDAR (Light Detection and Ranging)
- In-vehicle Networking
- Powertrain & Drive Control
- Power Control & Conversion
- Industrial Control & Automation

Electrical Specifications

Parameters	Min.	Typ.	Max.	Units	Notes
Frequency Range	8.000		54.000	MHz	
Operation Mode	Fundamental				
Operating Temperature ^[Note 1]	-40		+125	°C	Option "blank"; See options
	-40		+150		Option "V"; See options
Storage Temperature ^[Note 1]	-40		+125	°C	Option "blank, J, D, N"
	-40		+150		Option "V"
Frequency Tolerance @ +25°C	-50		+50	ppm	Option "blank"; See options
Frequency Stability over the Operating Temperature (ref. to +25°C)	-100		+100	ppm	Option "blank"; See options
	-150		+150		Option "R"; See options
Equivalent series resistance (R1)			500	Ω	8.000 – 9.999 MHz
			100		10.000 – 15.999 MHz
			70		16.000 – 19.999 MHz
			50		20.000 – 25.999 MHz
			40		26.000 – 39.999 MHz
			35		40.000 – 54.000 MHz
Shunt capacitance (C0)			2.0	pF	
Load capacitance (CL)	18			pF	Option "blank"; See options
Drive Level		10	100	μW	
Aging	-2		+2	ppm	@25°C± 3°C First year
Insulation Resistance	500			MΩ	@100 Vdc ± 15V

Note 1: Operating temperature range option -40°C to +150°C only available in select frequencies and electrical performance options. Please contact Abracon for availability.



ABM8AIG



3.2 x 2.5 x 0.8 mm
RoHS/RoHS II Compliant
 MSL = N/A: Not Applicable

Options and Part Identification (left blank if standard)

ABM8AIG- MHz - - - -

Frequency in MHz
 Please specify the frequency in MHz. (e.g. 14.31818MHz)

Load Capacitance (pF)
 Blank: 18pF
 If not standard, please specify CL in pF or S for series

Custom ESR if other than standard
 R □: Specify a value in Ω (e.g.: R80)

Packaging
 Blank: Bulk
 T: 1k pcs / reel
 T3: 3k pcs / reel

Operating Temp.
 Blank: -40°C to +125°C
 N: -30°C to +85°C
 D: -40°C to +85°C
 J: -40°C to +105°C
 V: -40°C to +150°C (*)

(*) Contact Abracon for Availability

Freq. Tolerance
 Blank: ± 50 ppm
 4: ± 30 ppm
 3: ± 25 ppm
 2: ± 20 ppm
 7: ± 15 ppm
 1: ± 10 ppm

Freq. Stability
 Blank: ± 100 ppm
 R: ± 150 ppm
 Z: ± 50 ppm
 P: ± 45 ppm (*)
 F: ± 40 ppm (*)
 H: ± 35 ppm (*)
 Y: ± 30 ppm (*)
 W: ± 25 ppm (*)
 X: ± 20 ppm (*)
 G: ± 15 ppm (*)

(*) Contact Abracon for Availability



ABM8AIG



3.2 x 2.5 x 0.8 mm
 RoHS/RoHS II Compliant
 MSL = N/A: Not Applicable

Mechanical Dimensions

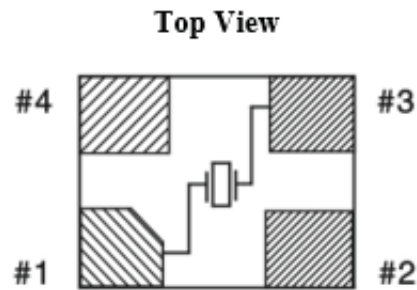
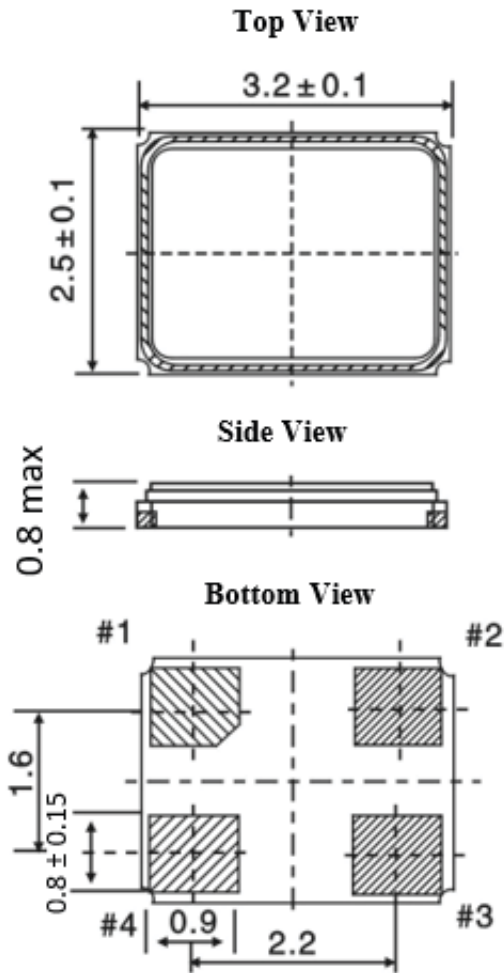

Pin #1: Crystal
 Pin #3: Crystal

Pin #2: GND (*)
 Pin #4: GND (*)
 (*) Electrically connected to lid

Recommended Land Pattern

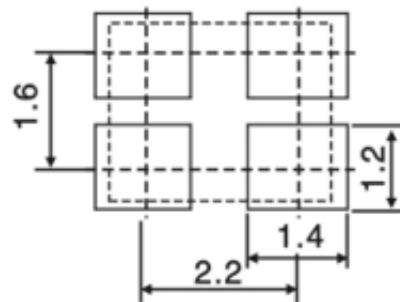

Note: Due to availability of raw materials, this part may be manufactured with the chamfer on pin 1 or pin 4. Be advised that this does not affect the electrical characteristics of the crystal in any way.

Dimensions: mm



ABM8AIG



3.2 x 2.5 x 0.8 mm
 RoHS/RoHS II Compliant
 MSL = N/A: Not Applicable

Reflow Profile

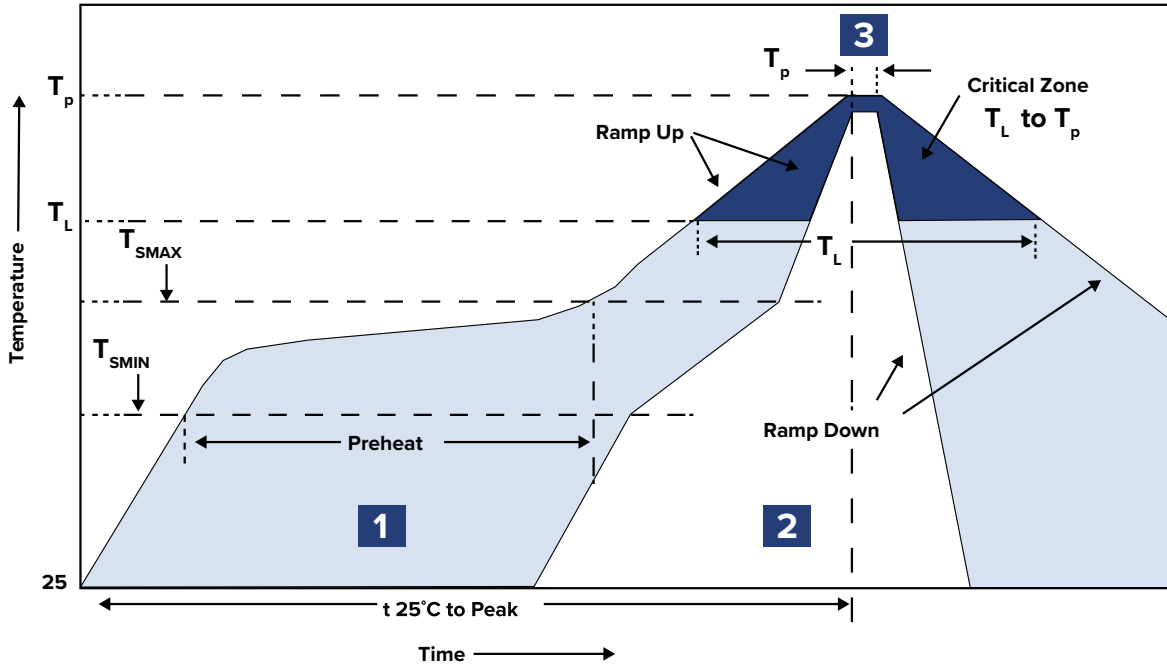

Zone	Description	Temperature	Time
1	Preheat / Soak	$T_{SMIN} \sim T_{SMAX}$ 150°C ~ 180°C	60 ~ 120 sec.
2	Reflow	T_L 230°C	30 ~ 40 sec.
3	Peak heat	T_P 260°C±5°C	10 sec. MAX



ABM8AIG



3.2 x 2.5 x 0.8 mm
 RoHS/RoHS II Compliant
 MSL = N/A: Not Applicable

Packaging

Tape and Reel:
 T: 1,000pcs/reel
 T3: 3,000pcs/reel

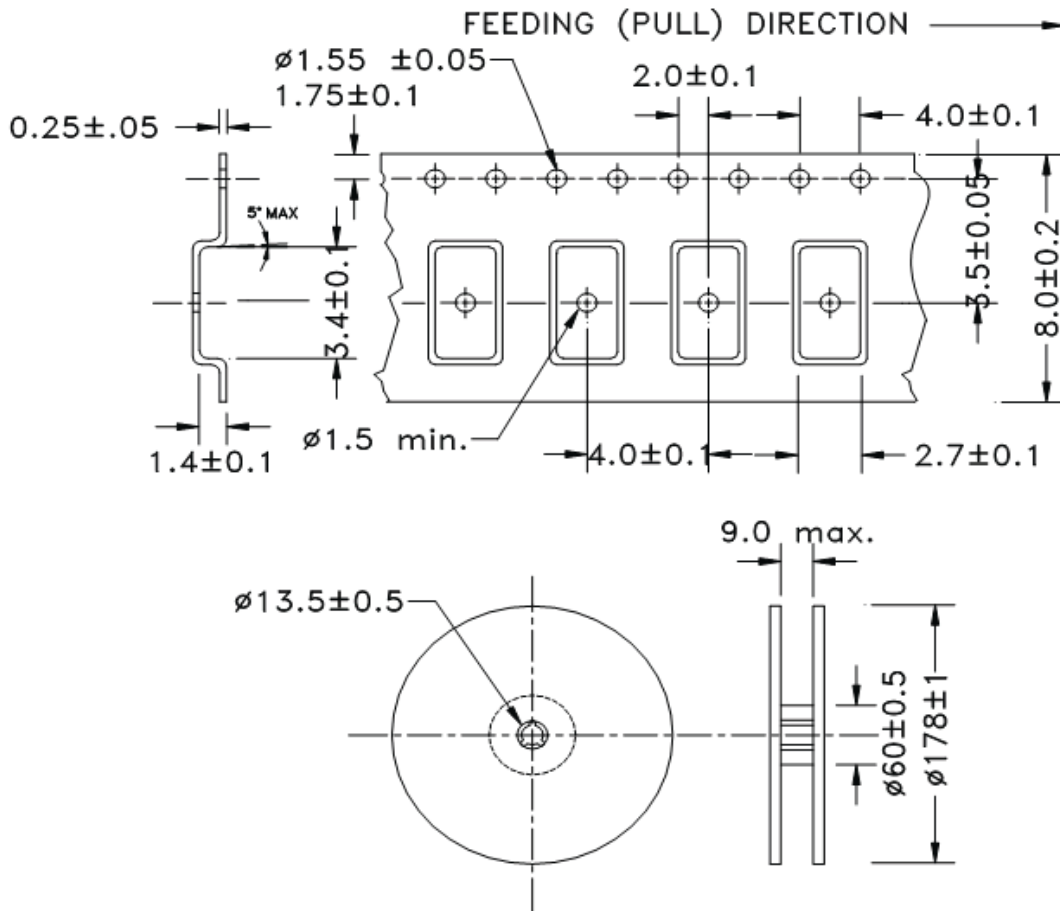

Dimensions: mm

ATTENTION: Abracon LLC's products are COTS – Commercial-Off-The-Shelf products; suitable for Commercial, Industrial and, where designated, Automotive Applications. Abracon's products are not specifically designed for Military, Aviation, Aerospace, Life-dependent Medical applications or any application requiring high reliability where component failure could result in loss of life and/or property. For applications requiring high reliability and/or presenting an extreme operating environment, written consent and authorization from Abracon LLC is required. Please contact Abracon LLC for more information.

Looking for pricing, stock, or lifecycle information?

Click below to explore more details on WIN SOURCE:

- ⊖ [View ABM8AIG-16.384MHZ-12-2Z-T3 on WIN SOURCE](#)
- ⊖ [Abracon LLC Information](#)

Optimize Your Supply Chain with WIN SOURCE Solutions

- ✓ Global Sourcing Solution
- ✓ Obsolete Management
- ✓ Cost Control Management
- ✓ Shortage Management
- ✓ Alternative Solution
- ✓ Excess Inventory Management