



THE DATASHEET OF
74402800011



Spezifikation für Freigabe / specification for release

Kunde / customer :
 Artikelnummer / part number : **74402800011**
 Bezeichnung : **SPEICHERDROSSEL WE-TPC**
 description : **POWER-CHOKE WE-TPC**



DATUM / DATE : 2010-10-01

A Mechanische Abmessungen / dimensions:

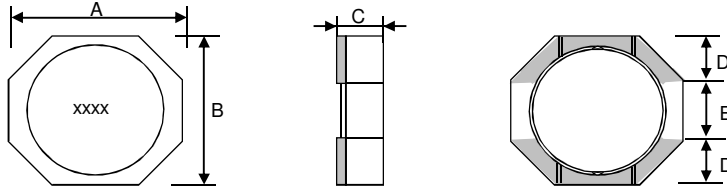

size	2811	
A	2,8 ± 0,2	mm
B	2,8 ± 0,2	mm
C	1,1 ± 0,10	mm
D	0,9 typ.	mm
E	0,9 typ.	mm

B Elektrische Eigenschaften / electrical properties:

C Lötspad / soldering spec.:

Eigenschaften / properties	Testbedingungen / test conditions		Wert / value	Einheit / unit	tol.
Induktivität / inductance	100 kHz / 10mA	Lo	0,11	μH	±35%
DC-Widerstand / DC-resistance	@ 20°C	R _{DC} typ.	13	mΩ	typ.
DC-Widerstand / DC-resistance	@ 20°C	R _{DC} max.	18	mΩ	max.
Nennstrom / rated Current	ΔT = 40 K	I _N	4,1	A	typ.
Sättigungsstrom / saturation current	ΔL/L = < 35%	I _{sat}	4,8	A	typ.
Eigenres.-Frequenz / self-res.-frequency		SRF	2000	MHz	typ.

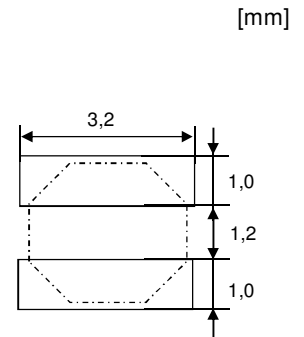

D Prüfgeräte / test equipment:

E Testbedingungen / test conditions:

WAYNE KERR 3260B für/for L₀; I_{SAT}
HP 34401 A & Fluke 54II für/for I_{DC};
Metra HIT 271 für/for R_{DC}

Luftfeuchtigkeit / humidity: 33%
 Umgebungstemperatur / temperature: +20 °C

F Werkstoffe & Zulassungen / material & approvals:

G Eigenschaften / general specifications:

Basismaterial / base material: Ferrit/ ferrite
 Draht / wire: Class H /180 °C
 Endoberfläche / finishing electrode: Ag/Ni/Sn

Betriebstemp. / operating temperature: -40 °C - + 125 °C
 Umgebungstemp. / ambient temperature: -40 °C - + 85 °C
 It is recommended that the temperature of the part does not exceed 125 °C under worst case operating conditions.

Freigabe erteilt / general release:	Kunde / customer		
.....		
Datum / date	Unterschrift / signature		
	Würth Elektronik		
.....		
Geprüft / checked	Kontrolliert / approved		
	Name	Änderung / modification	Datum / date
	ME	Version 3	10-10-01
	ME	Version 2	08-04-01
	ME	Version 1	07-07-01

Würth Elektronik eISos GmbH & Co. KG

D-74638 Waldenburg · Max-Eyth-Strasse 1 · Germany · Telefon (+49) (0) 7942 - 945 - 0 · Telefax (+49) (0) 7942 - 945 - 400
<http://www.we-online.de>

Spezifikation für Freigabe / specification for release

Kunde / customer :
 Artikelnummer / part number : **74402800011**
 Bezeichnung : **SPEICHERDROSSEL WE-TPC**
 description : **POWER-CHOKE WE-TPC**



DATUM / DATE : 2010-10-01

H Induktivitätskurve / Inductance curve:

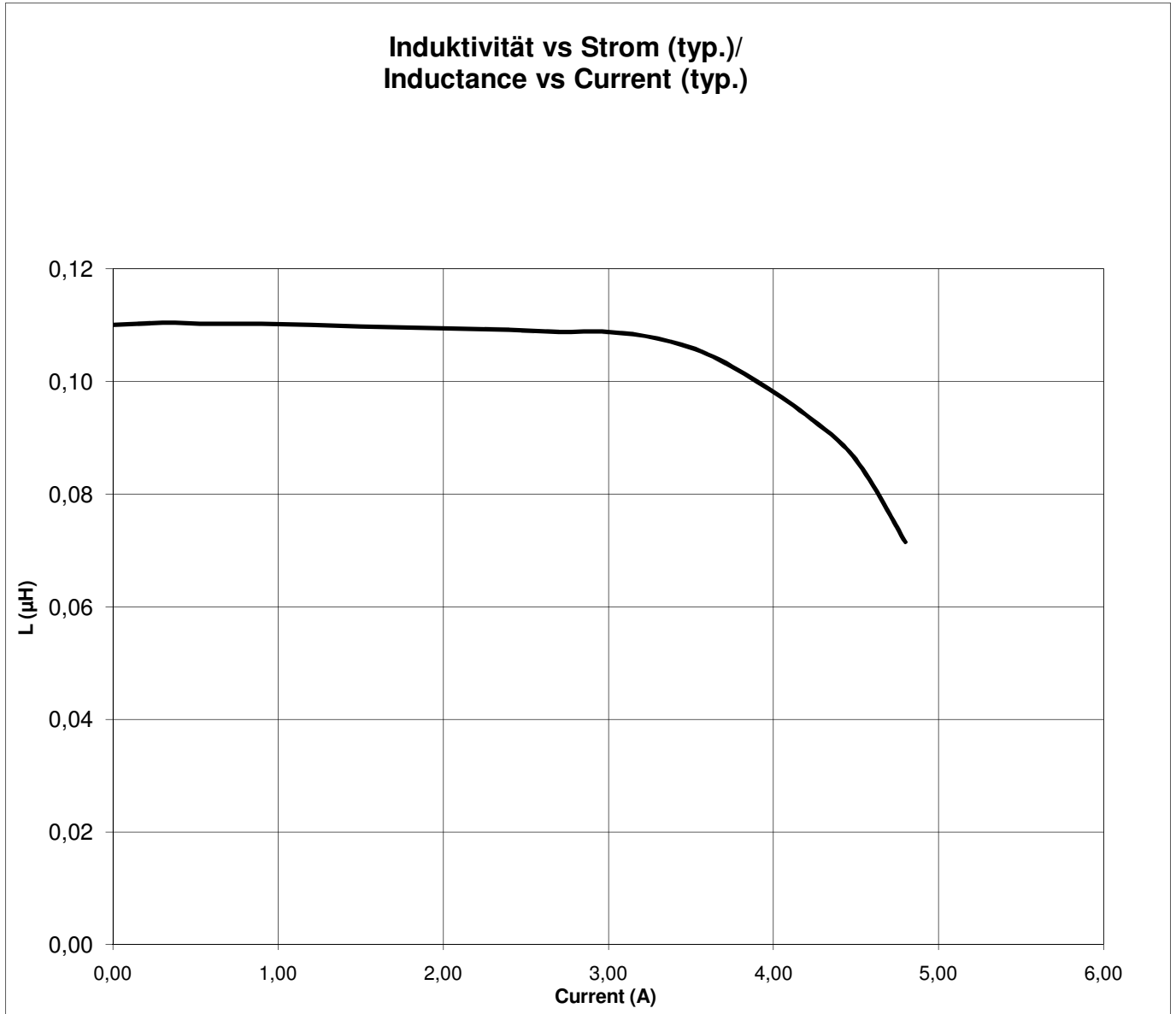

Freigabe erteilt / general release:	Kunde / customer			
.....			
Datum / date	Unterschrift / signature			
	Würth Elektronik	ME	Version 3	10-10-01
		ME	Version 2	08-04-01
.....	ME	Version 1	07-07-01
Geprüft / checked	Kontrolliert / approved	Name	Änderung / modification	Datum / date

Spezifikation für Freigabe / specification for release

Kunde / customer :
 Artikelnummer / part number : **74402800011**
 Bezeichnung : **SPEICHERDROSSEL WE-TPC**
 description : **POWER-CHOKE WE-TPC**



DATUM / DATE : 2010-10-01

I Rollenspezifikation / tape and reel specification:

Gurtspezifikation / Tape specification:

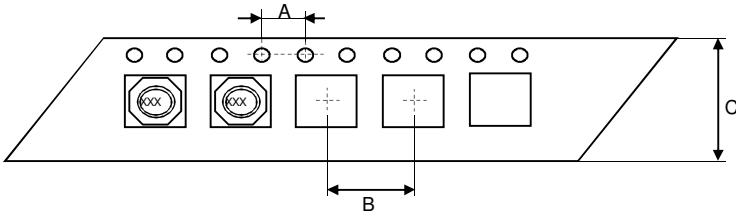

A	4,00 ± 0,1	mm
B	8,00 ± 0,1	mm
C	12,0 ± 0,2	mm

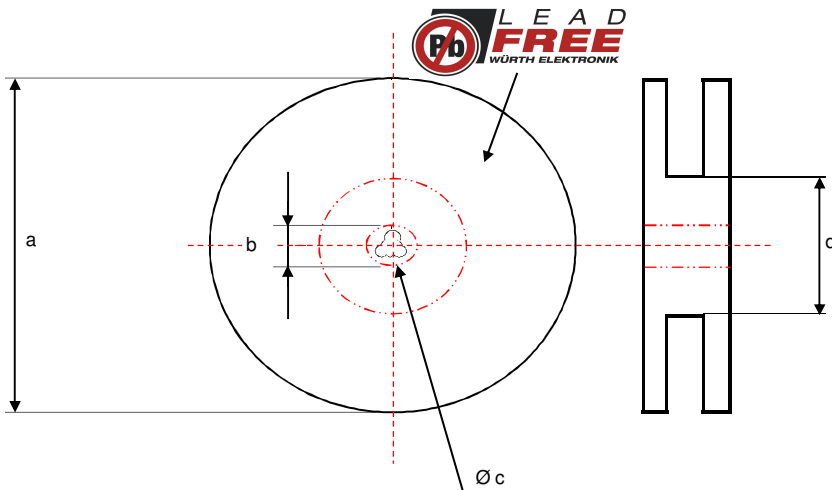
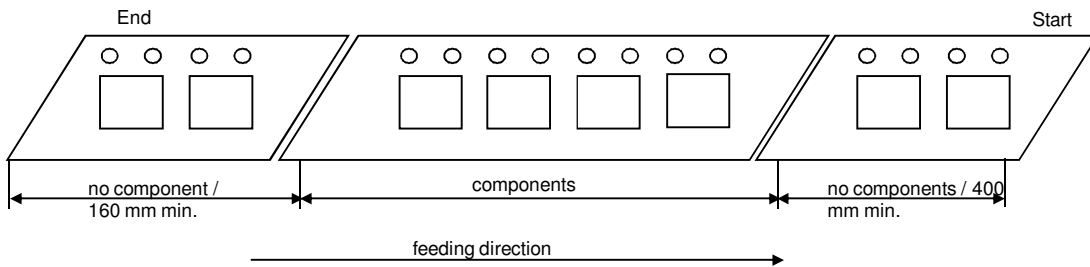

Rollenspezifikation / Reel specification:

a	178,0 ± 2,0	mm
b	21,00 ± 0,8	mm
c	13,00 ± 0,5	mm
d	50,00 ± 1,0	mm

Freigabe erteilt / general release:	Kunde / customer			
Datum / date	Unterschrift / signature			
	Würth Elektronik	ME	Version 3	10-10-01
		ME	Version 2	08-04-01
		ME	Version 1	07-07-01
Geprüft / checked	Kontrolliert / approved	Name	Änderung / modification	Datum / date



This electronic component has been designed and developed for usage in general electronic equipment. Before incorporating this component into any equipment where higher safety and reliability is especially required or if there is the possibility of direct damage or injury to human body, for example in the range of aerospace, aviation, nuclear control, submarine, transportation, (automotive control, train control, ship control), transportation signal, disaster prevention, medical, public information network etc, Würth Elektronik eiSos GmbH must be informed before the design-in stage. In addition, sufficient reliability evaluation checks for safety must be performed on every electronic component which is used in electrical circuits that require high safety and reliability functions or performance.

Würth Elektronik eiSos GmbH & Co. KG

D-74638 Waldenburg · Max-Eyth-Strasse 1 · Germany · Telefon (+49) (0) 7942 - 945 - 0 · Telefax (+49) (0) 7942 - 945 - 400
<http://www.we-online.de>

Looking for pricing, stock, or lifecycle information?

Click below to explore more details on WIN SOURCE:

-  [View 74402800011 on WIN SOURCE](#)
-  [Wurth Electronics Inc Information](#)

Optimize Your Supply Chain with WIN SOURCE Solutions

-  Global Sourcing Solution
-  Obsolete Management
-  Cost Control Management
-  Shortage Management
-  Alternative Solution
-  Excess Inventory Management