



THE DATASHEET OF
71V632S5PFG8



Features

- ◆ 64K x 32 memory configuration
- ◆ Supports high system speed:
Commercial and Industrial:
 - 5 5ns clock access time (100 MHz)
 - 6 6ns clock access time (83 MHz)
 - 7 7ns clock access time (66 MHz)
- ◆ Single-cycle deselect functionality
- ◆ LBO input selects interleaved or linear burst mode
- ◆ Self-timed write cycle with global write control (\overline{GW}), byte write enable (\overline{BWE}), and byte writes (\overline{BWx})
- ◆ Power down controlled by ZZ input
- ◆ Operates with a single 3.3V power supply (+10/-5%)
- ◆ Packaged in a JEDEC Standard 100-pin rectangular plastic thin quad flatpack (TQFP)
- ◆ Green parts available, see ordering information

Functional Block Diagram

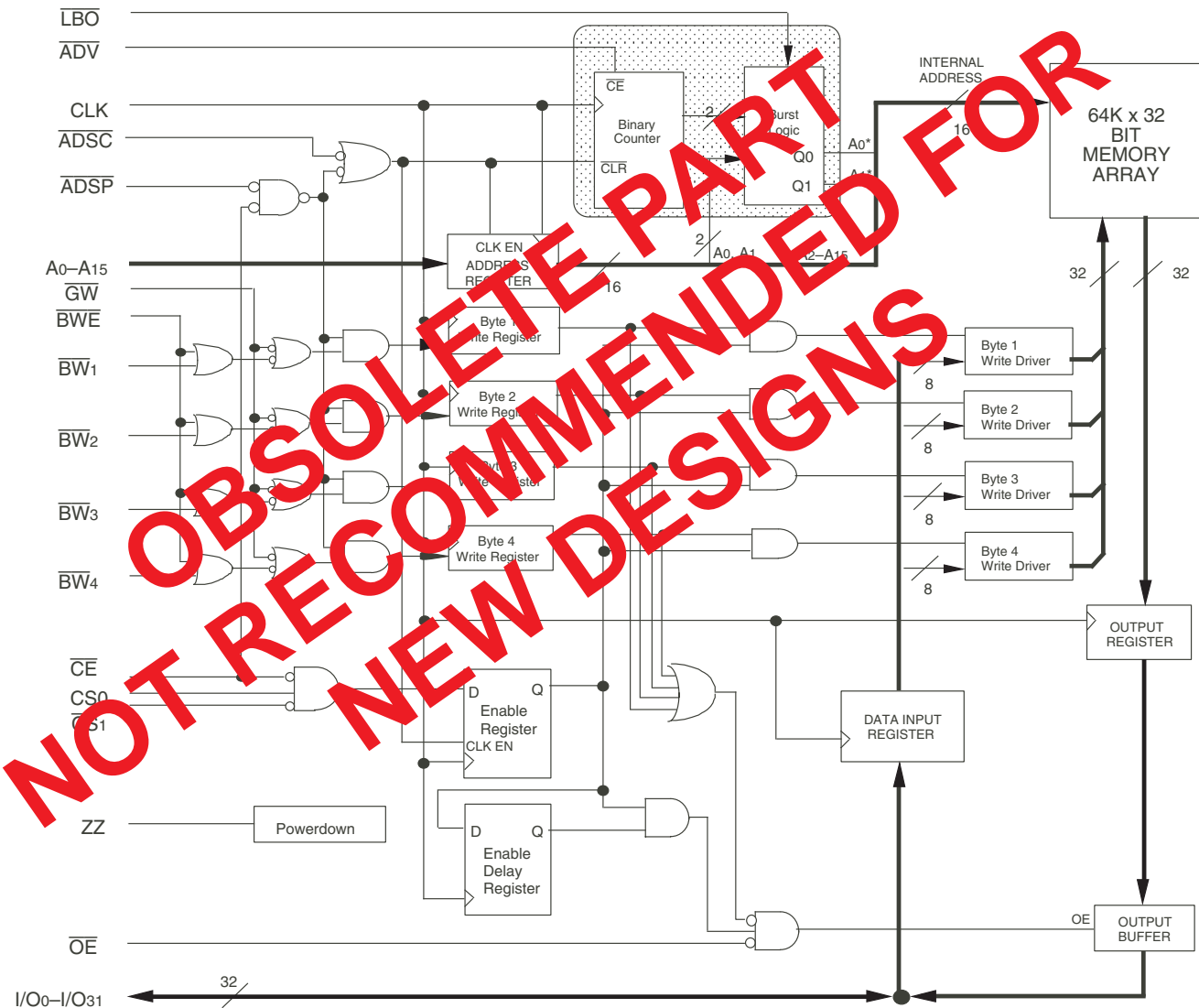

3619 drw 01

Description

The IDT71V632 is a 3.3V high-speed SRAM organized as 64K x 32 with full support of the Pentium™ and PowerPC™ processor interfaces. The pipelined burst architecture provides cost-effective 3-1-1-1 secondary cache performance for processors up to 100MHz.

The IDT71V632 SRAM contains write, data, address, and control registers. Internal logic allows the SRAM to generate a self-timed write based upon a decision which can be left until the extreme end of the write cycle.

The burst mode feature offers the highest level of performance to the system designer, as the IDT71V632 can provide four cycles of data for

a single address presented to the SRAM. An internal burst address counter accepts the first cycle address from the processor, initiating the access sequence. The first cycle of output data will be pipelined for one cycle before it is available on the next rising clock edge. If burst mode operation is selected (\overline{ADV} =LOW), the subsequent three cycles of output data will be available to the user on the next three rising clock edges. The order of these three addresses will be defined by the internal burst counter and the \overline{LBO} input pin.

The IDT71V632 SRAM utilizes a high-performance, high-volume 3.3V CMOS process, and is packaged in a JEDEC Standard 14mm x 20mm 100-pin thin plastic quad flatpack (TQFP) for optimum board density in both desktop and notebook applications.

Pin Description Summary

A ₀ -A ₁₅	Address Inputs	Input	Synchronous
\overline{CE}	Chip Enable	Input	Synchronous
CS ₀ , \overline{CS}_1	Chips Selects	Input	Synchronous
\overline{OE}	Output Enable	Input	Asynchronous
\overline{GW}	Global Write Enable	Input	Synchronous
\overline{BWE}	Byte Write Enable	Input	Synchronous
\overline{BW}_1 , \overline{BW}_2 , \overline{BW}_3 , \overline{BW}_4	Individual Byte Write Selects	Input	Synchronous
CLK	Clock	Input	N/A
\overline{ADV}	Burst Address Advance	Input	Synchronous
\overline{ADSC}	Address Status (Cache Controller)	Input	Synchronous
\overline{ADSP}	Address Status (Processor)	Input	Synchronous
\overline{LBO}	Linear / Interleaved Burst Order	Input	DC
ZZ	Sleep Mode	Input	Asynchronous
I/O ₀ -I/O ₃₁	Data Input/Output	I/O	Synchronous
V _{DD} , V _{DD0}	3.3V	Power	N/A
V _{SS} , V _{SS0}	Array Ground, I/O Ground	Power	N/A

3619 tbl 01

Pin Definitions⁽¹⁾

Symbol	Pin Function	I/O	Active	Description
A0–A15	Address Inputs	I	N/A	Synchronous Address inputs. The address register is triggered by a combination of the rising edge of CLK and \overline{ADSC} Low or \overline{ADSP} Low and \overline{CE} Low.
\overline{ADSC}	Address Status (Cache Controller)	I	LOW	Synchronous Address Status from Cache Controller. \overline{ADSC} is an active LOW input that is used to load the address registers with new addresses. \overline{ADSC} is NOT GATED by \overline{CE} .
\overline{ADSP}	Address Status (Processor)	I	LOW	Synchronous Address Status from Processor. \overline{ADSP} is an active LOW input that is used to load the address registers with new addresses. \overline{ADSP} is gated by \overline{CE} .
\overline{ADV}	Burst Address Advance	I	LOW	Synchronous Address Advance. \overline{ADV} is an active LOW input that is used to advance the internal burst counter, controlling burst access after the initial address is loaded. When this input is HIGH the burst counter is not incremented; that is, there is no address advance.
\overline{BWE}	Byte Write Enable	I	LOW	Synchronous byte write enable gates the byte write inputs $\overline{BW1}$ – $\overline{BW4}$. If \overline{BWE} is LOW at the rising edge of CLK then \overline{BWx} inputs are passed to the next stage in the circuit. A byte write can still be blocked if \overline{ADSP} is LOW at the rising edge of CLK. If \overline{ADSP} is HIGH and \overline{BWx} is LOW at the rising edge of CLK then data will be written to the SRAM. If \overline{BWE} is HIGH then the byte write inputs are blocked and only \overline{GW} can initiate a write cycle.
$\overline{BW1}$ – $\overline{BW4}$	Individual Byte Write Enables	I	LOW	Synchronous byte write enables. $\overline{BW1}$ controls I/O(7:0), $\overline{BW2}$ controls I/O(15:8), etc. Any active byte write causes all outputs to be disabled. \overline{ADSP} LOW disables all byte writes. $\overline{BW1}$ – $\overline{BW4}$ must meet specified setup and hold times with respect to CLK.
\overline{CE}	Chip Enable	I	LOW	Synchronous chip enable. \overline{CE} is used with CS_0 and \overline{CS}_1 to enable the IDT71V632. \overline{CE} also gates \overline{ADSP} .
CLK	Clock	I	N/A	This is the clock input. All timing references for the device are made with respect to this input.
CS_0	Chip Select 0	I	HIGH	Synchronous active HIGH chip select. CS_0 is used with \overline{CE} and \overline{CS}_1 to enable the chip.
\overline{CS}_1	Chip Select 1	I	LOW	Synchronous active LOW chip select. \overline{CS}_1 is used with \overline{CE} and CS_0 to enable the chip.
\overline{GW}	Global Write Enable	I	LOW	Synchronous global write enable. This input will write all four 8-bit data bytes when LOW on the rising edge of CLK. \overline{GW} supercedes individual byte write enables.
I/O ₀ –I/O ₃₁	Data Input/Output	I/O	N/A	Synchronous data input/output (I/O) pins. Both the data input path and data output path are registered and triggered by the rising edge of CLK.
\overline{LBO}	Linear Burst Order	I	LOW	Asynchronous burst order selection DC input. When \overline{LBO} is HIGH the Interleaved (Intel) burst sequence is selected. When \overline{LBO} is LOW the Linear (PowerPC) burst sequence is selected. \overline{LBO} is a static DC input and must not change state while the device is operating.
\overline{OE}	Output Enable	I	LOW	Asynchronous output enable. When \overline{OE} is LOW the data output drivers are enabled on the I/O pins if the chip is also selected. When \overline{OE} is HIGH the I/O pins are in a high-impedance state.
V _{DD}	Power Supply	N/A	N/A	3.3V core power supply inputs.
V _{DDQ}	Power Supply	N/A	N/A	3.3V I/O power supply inputs.
V _{SS}	Ground	N/A	N/A	Core ground pins.
V _{SSQ}	Ground	N/A	N/A	I/O ground pins.
NC	No Connect	N/A	N/A	NC pins are not electrically connected to the chip.
ZZ	Sleep Mode	I	HIGH	Asynchronous sleep mode input. ZZ HIGH will gate the CLK internally and power down the IDT71V632 to its lowest power consumption level. Data retention is guaranteed in Sleep Mode.

NOTE:

1. All synchronous inputs must meet specified setup and hold times with respect to CLK.

3619 tbl 02

Absolute Maximum Ratings⁽¹⁾

Symbol	Rating	Value	Unit
V _{TERM} ⁽²⁾	Terminal Voltage with Respect to GND	-0.5 to +4.6	V
V _{TERM} ⁽³⁾	Terminal Voltage with Respect to GND	-0.5 to V _{DD} +0.5	V
T _A	Operating Temperature	0 to +70	°C
T _{BIAS}	Temperature Under Bias	-55 to +125	°C
T _{STG}	Storage Temperature	-55 to +125	°C
P _T	Power Dissipation	1.0	W
I _{OUT}	DC Output Current	50	mA

3619 tbl 05

NOTES:

- Stresses greater than those listed under ABSOLUTE MAXIMUM RATINGS may cause permanent damage to the device. This is a stress rating only and functional operation of the device at these or any other conditions above those indicated in the operational sections of this specification is not implied. Exposure to absolute maximum rating conditions for extended periods may affect reliability.
- V_{DD}, V_{DDQ} and Input terminals only.
- I/O terminals.

Capacitance

(T_A = +25°C, f = 1.0MHz, TQFP package)

Symbol	Parameter ⁽¹⁾	Conditions	Max.	Unit
C _{IN}	Input Capacitance	V _{IN} = 3dV	6	pF
C _{I/O}	I/O Capacitance	V _{OUT} = 3dV	7	pF

3619 tbl 06

NOTE:

- This parameter is guaranteed by device characterization, but not production tested.

Recommended Operating Temperature and Supply Voltage

Grade	Temperature	V _{SS}	V _{DD}	V _{DDQ}
Commercial	0°C to +70°C	0V	3.3V+10/-5%	3.3V+10/-5%
Industrial	-40°C to +85°C	0V	3.3V+10/-5%	3.3V+10/-5%

3619 tbl 03

Recommended DC Operating Conditions

Symbol	Parameter	Min.	Max.	Unit
V _{DD}	Core Supply Voltage	3.135	3.63	V
V _{DDQ}	I/O Supply Voltage	3.135	3.63	V
V _{SS} , V _{SSQ}	Ground	0	0	V
V _{IH}	Input High Voltage — Inputs	2.0	5.0 ⁽¹⁾	V
V _{IH}	Input High Voltage — I/O	2.0	V _{DDQ} +0.3 ⁽²⁾	V
V _{IL}	Input Low Voltage	-0.3 ⁽³⁾	0.8	V

3619 tbl 04

NOTES:

- V_{IH} (max) = 6.0V for pulse width less than t_{cy}/2, once per cycle.
- V_{IH} (max) = V_{DDQ} + 1.0V for pulse width less than t_{cy}/2, once per cycle.
- V_{IL} (min) = -1.0V for pulse width less than t_{cy}/2, once per cycle.

Pin Configuration

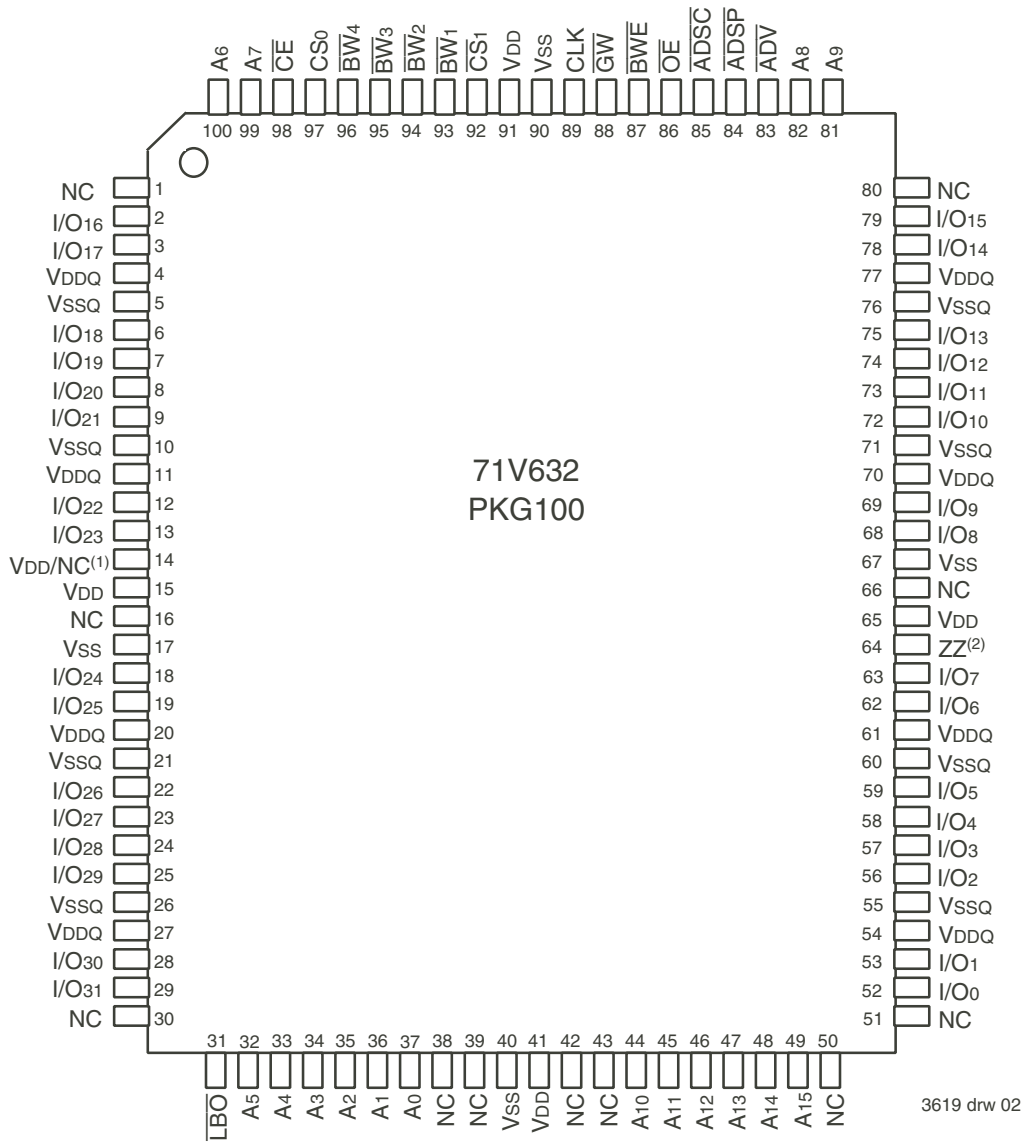

Top View TQFP

NOTES:

1. Pin 14 can either be directly connected to V_{DD} or not connected.
2. Pin 64 can be left unconnected and the device will always remain in active mode.

Synchronous Truth Table^(1,2)

Operation	Address Used	\overline{CE}	CS ₀	\overline{CS}_1	\overline{ADSP}	\overline{ADSC}	\overline{ADV}	\overline{GW}	\overline{BWE}	\overline{BW}_x	$\overline{OE}^{(3)}$	CLK	I/O
Deselected Cycle, Power Down	None	H	X	X	X	L	X	X	X	X	X	↑	Hi-Z
Deselected Cycle, Power Down	None	L	X	H	L	X	X	X	X	X	X	↑	Hi-Z
Deselected Cycle, Power Down	None	L	L	X	L	X	X	X	X	X	X	↑	Hi-Z
Deselected Cycle, Power Down	None	L	X	H	X	L	X	X	X	X	X	↑	Hi-Z
Deselected Cycle, Power Down	None	L	L	X	X	L	X	X	X	X	X	↑	Hi-Z
Read Cycle, Begin Burst	External	L	H	L	L	X	X	X	X	X	L	↑	DOUT
Read Cycle, Begin Burst	External	L	H	L	L	X	X	X	X	X	H	↑	Hi-Z
Read Cycle, Begin Burst	External	L	H	L	H	L	X	H	H	X	L	↑	DOUT
Read Cycle, Begin Burst	External	L	H	L	H	L	X	H	L	H	L	↑	DOUT
Read Cycle, Begin Burst	External	L	H	L	H	L	X	H	L	H	H	↑	Hi-Z
Write Cycle, Begin Burst	External	L	H	L	H	L	X	H	L	L	X	↑	DIN
Write Cycle, Begin Burst	External	L	H	L	H	L	X	L	X	X	X	↑	DIN
Read Cycle, Continue Burst	Next	X	X	X	H	H	L	H	H	X	L	↑	DOUT
Read Cycle, Continue Burst	Next	X	X	X	H	H	L	H	H	X	H	↑	Hi-Z
Read Cycle, Continue Burst	Next	X	X	X	H	H	L	H	X	H	L	↑	DOUT
Read Cycle, Continue Burst	Next	X	X	X	H	H	L	H	X	H	H	↑	Hi-Z
Read Cycle, Continue Burst	Next	H	X	X	X	H	L	H	H	X	L	↑	DOUT
Read Cycle, Continue Burst	Next	H	X	X	X	H	L	H	H	X	H	↑	Hi-Z
Read Cycle, Continue Burst	Next	H	X	X	X	H	L	H	X	H	L	↑	DOUT
Read Cycle, Continue Burst	Next	H	X	X	X	H	L	H	X	H	H	↑	Hi-Z
Write Cycle, Continue Burst	Next	X	X	X	H	H	L	H	L	L	X	↑	DIN
Write Cycle, Continue Burst	Next	X	X	X	H	H	L	L	X	X	X	↑	DIN
Write Cycle, Continue Burst	Next	H	X	X	X	H	L	H	L	L	X	↑	DIN
Write Cycle, Continue Burst	Next	H	X	X	X	H	L	L	X	X	X	↑	DIN
Read Cycle, Suspend Burst	Current	X	X	X	H	H	H	H	H	X	L	↑	DOUT
Read Cycle, Suspend Burst	Current	X	X	X	H	H	H	H	H	X	H	↑	Hi-Z
Read Cycle, Suspend Burst	Current	X	X	X	H	H	H	H	X	H	L	↑	DOUT
Read Cycle, Suspend Burst	Current	X	X	X	H	H	H	H	X	H	H	↑	Hi-Z
Read Cycle, Suspend Burst	Current	H	X	X	X	H	H	H	H	X	L	↑	DOUT
Read Cycle, Suspend Burst	Current	H	X	X	X	H	H	H	H	X	H	↑	Hi-Z
Read Cycle, Suspend Burst	Current	H	X	X	X	H	H	H	X	H	L	↑	DOUT
Read Cycle, Suspend Burst	Current	H	X	X	X	H	H	H	X	H	H	↑	Hi-Z
Write Cycle, Suspend Burst	Current	X	X	X	H	H	H	H	L	L	X	↑	DIN
Write Cycle, Suspend Burst	Current	X	X	X	H	H	H	L	X	X	X	↑	DIN
Write Cycle, Suspend Burst	Current	H	X	X	X	H	H	H	L	L	X	↑	DIN
Write Cycle, Suspend Burst	Current	H	X	X	X	H	H	L	X	X	X	↑	DIN

NOTES:

1. L = V_{IL}, H = V_{IH}, X = Don't Care.
2. ZZ = LOW for this table.
3. \overline{OE} is an asynchronous input.

3619 tbl 07

Synchronous Write Function Truth Table⁽¹⁾

Operation	\overline{GW}	\overline{BWE}	\overline{BW}_1	\overline{BW}_2	\overline{BW}_3	\overline{BW}_4
Read	H	H	X	X	X	X
Read	H	L	H	H	H	H
Write all Bytes	L	X	X	X	X	X
Write all Bytes	H	L	L	L	L	L
Write Byte 1 ⁽²⁾	H	L	L	H	H	H
Write Byte 2 ⁽²⁾	H	L	H	L	H	H
Write Byte 3 ⁽²⁾	H	L	H	H	L	H
Write Byte 4 ⁽²⁾	H	L	H	H	H	L

NOTES:

1. L = V_{IL} , H = V_{IH} , X = Don't Care.
2. Multiple bytes may be selected during the same cycle.

3619 tbl 08

Asynchronous Truth Table⁽¹⁾

Operation ⁽²⁾	\overline{OE}	\overline{ZZ}	I/O Status	Power
Read	L	L	Data Out (I/O ₀ - I/O ₃₁)	Active
Read	H	L	High-Z	Active
Write	X	L	High-Z — Data In (I/O ₀ - I/O ₃₁)	Active
Deselected	X	L	High-Z	Standby
Sleep	X	H	High-Z	Sleep

NOTES:

1. L = V_{IL} , H = V_{IH} , X = Don't Care.
2. Synchronous function pins must be biased appropriately to satisfy operation requirements.

3619 tbl 09

Interleaved Burst Sequence Table ($\overline{LBO} = V_{DD}$)

	Sequence 1		Sequence 2		Sequence 3		Sequence 4	
	A1	A0	A1	A0	A1	A0	A1	A0
First Address	0	0	0	1	1	0	1	1
Second Address	0	1	0	0	1	1	1	0
Third Address	1	0	1	1	0	0	0	1
Fourth Address ⁽¹⁾	1	1	1	0	0	1	0	0

NOTE:

1. Upon completion of the Burst sequence the counter wraps around to its initial state.

3619 tbl 10

Linear Burst Sequence Table ($\overline{LBO} = V_{SS}$)

	Sequence 1		Sequence 2		Sequence 3		Sequence 4	
	A1	A0	A1	A0	A1	A0	A1	A0
First Address	0	0	0	1	1	0	1	1
Second Address	0	1	1	0	1	1	0	0
Third Address	1	0	1	1	0	0	0	1
Fourth Address ⁽¹⁾	1	1	0	0	0	1	1	0

NOTE:

1. Upon completion of the Burst sequence the counter wraps around to its initial state.

3619 tbl 11

DC Electrical Characteristics Over the Operating Temperature and Supply Voltage Range ($V_{DD} = 3.3V \pm 10\%/ -5\%$)

Symbol	Parameter	Test Conditions	Min.	Max.	Unit
$ I_{LI} $	Input Leakage Current	$V_{DD} = \text{Max.}, V_{IN} = 0V \text{ to } V_{DD}$	—	5	μA
$ I_{LZZ} $	ZZ and $\overline{LB0}$ Input Leakage Current ⁽¹⁾	$V_{DD} = \text{Max.}, V_{IN} = 0V \text{ to } V_{DD}$	—	30	μA
$ I_{LO} $	Output Leakage Current	$\overline{CE} \geq V_{IH}$ or $\overline{OE} \geq V_{IH}, V_{OUT} = 0V \text{ to } V_{DD}, V_{DD} = \text{Max.}$	—	5	μA
$V_{OL} (3.3V)$	Output Low Voltage	$I_{OL} = 5mA, V_{DD} = \text{Min.}$	—	0.4	V
$V_{OH} (3.3V)$	Output High Voltage	$I_{OH} = -5mA, V_{DD} = \text{Min.}$	2.4	—	V

NOTE:

3619 tbl 12

- The $\overline{LB0}$ pin will be internally pulled to V_{DD} if it is not actively driven in the application and the ZZ pin will be internally pulled to V_{SS} if not actively driven.

DC Electrical Characteristics Over the Operating Temperature and Supply Voltage Range⁽¹⁾ ($V_{HD} = V_{DDQ} - 0.2V, V_{LD} = 0.2V$)

Symbol	Parameter	Test Conditions	SA4 ^(3,4)		S5		S6		S7		Unit
			Com'l.	Ind.	Com'l.	Ind.	Com'l.	Ind.	Com'l.	Ind.	
I_{DD}	Operating Power Supply Current	Device Selected, Outputs Open, $V_{DD} = \text{Max.}, V_{IN} \geq V_{IH}$ or $\leq V_{IL}, f = f_{MAX}^{(2)}$	220	—	200	200	180	180	160	160	mA
I_{SB}	Standby Power Supply Current	Device Deselected, Outputs Open, $V_{DD} = \text{Max.}, V_{IN} \geq V_{IH}$ or $\leq V_{IL}, f = f_{MAX}^{(2)}$	70	—	65	65	60	60	55	55	mA
I_{SB1}	Full Standby Power Supply Current	Device Deselected, Outputs Open, $V_{DD} = \text{Max.}, V_{IN} \geq V_{HD}$ or $\leq V_{LD}, f = 0^{(2)}$	15	—	15	15	15	15	15	15	mA
I_{ZZ}	Full Sleep Mode Power Supply Current	$ZZ \geq V_{HD}, V_{DD} = \text{Max.}$	10	—	10	10	10	10	10	10	mA

3619 tbl 13

NOTES:

- All values are maximum guaranteed values.
- At $f = f_{MAX}$, inputs are cycling at the maximum frequency of read cycles of $1/t_{cvc}$ while $\overline{ADSC} = \text{LOW}$; $f=0$ means no input lines are changing.
- SA4 speed grade corresponds to a t_{CD} of 4.5 ns.
- 0°C to +70°C temperature range only.

AC Test Loads

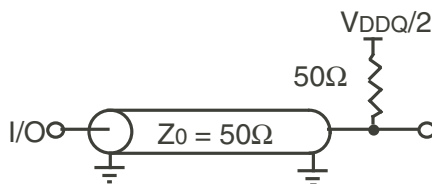
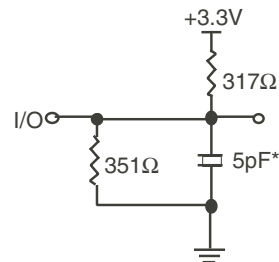

Figure 1. AC Test Load

3619 drw 03



* Including scope and jig capacitance.

Figure 2. High-Impedance Test Load
(for $t_{OHZ}, t_{CHZ}, t_{OLZ},$ and t_{DC1})

3619 drw 04

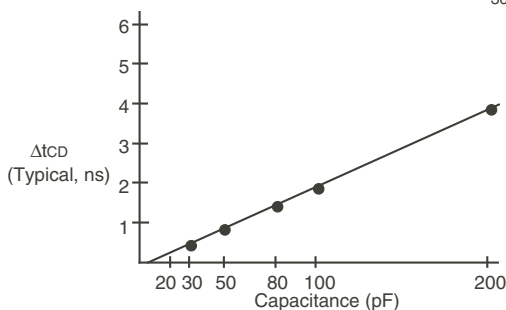

3619 drw 05

Figure 3. Lumped Capacitive Load, Typical Derating

AC Test Conditions

Input Pulse Levels	0 to 3.0V
Input Rise/Fall Times	2ns
Input Timing Reference Levels	1.5V
Output Timing Reference Levels	1.5V
AC Test Load	See Figures 1 and 2

3619 tbl 14

AC Electrical Characteristics

(VDD, VDDQ = 3.3V +10/-5%, Commercial and Industrial Temperature Ranges)

Symbol	Parameter	71V632SA4 ^(5,6)		71V632S5		71V632S6		71V632S7		Unit
		Min.	Max.	Min.	Max.	Min.	Max.	Min.	Max.	
CLOCK PARAMETERS										
t _{cyc}	Clock Cycle Time	8.5	—	10	—	12	—	15	—	ns
t _{CH} ⁽¹⁾	Clock High Pulse Width	3.5	—	4	—	4.5	—	5	—	ns
t _{CL} ⁽¹⁾	Clock Low Pulse Width	3.5	—	4	—	4.5	—	5	—	ns
OUTPUT PARAMETERS										
t _{CD}	Clock High to Valid Data	—	4.5	—	5	—	6	—	7	ns
t _{CDc}	Clock High to Data Change	1.5	—	1.5	—	2	—	2	—	ns
t _{CLZ} ⁽²⁾	Clock High to Output Active	0	—	0	—	0	—	0	—	ns
t _{CHZ} ⁽²⁾	Clock High to Data High-Z	1.5	4	1.5	5	2	5	2	6	ns
t _{OE}	Output Enable Access Time	—	4	—	5	—	5	—	6	ns
t _{OLZ} ⁽²⁾	Output Enable Low to Data Active	0	—	0	—	0	—	0	—	ns
t _{OHZ} ⁽²⁾	Output Enable High to Data High-Z	—	4	—	4	—	5	—	6	ns
SETUP TIMES										
t _{SA}	Address Setup Time	2.2	—	2.5	—	2.5	—	2.5	—	ns
t _{SS}	Address Status Setup Time	2.2	—	2.5	—	2.5	—	2.5	—	ns
t _{SD}	Data in Setup Time	2.2	—	2.5	—	2.5	—	2.5	—	ns
t _{SW}	Write Setup Time	2.2	—	2.5	—	2.5	—	2.5	—	ns
t _{SAV}	Address Advance Setup Time	2.2	—	2.5	—	2.5	—	2.5	—	ns
t _{SC}	Chip Enable/Select Setup Time	2.2	—	2.5	—	2.5	—	2.5	—	ns
HOLD TIMES										
t _{HA}	Address Hold Time	0.5	—	0.5	—	0.5	—	0.5	—	ns
t _{HS}	Address Status Hold Time	0.5	—	0.5	—	0.5	—	0.5	—	ns
t _{HD}	Data In Hold Time	0.5	—	0.5	—	0.5	—	0.5	—	ns
t _{HW}	Write Hold Time	0.5	—	0.5	—	0.5	—	0.5	—	ns
t _{HAV}	Address Advance Hold Time	0.5	—	0.5	—	0.5	—	0.5	—	ns
t _{HC}	Chip Enable/Select Hold Time	0.5	—	0.5	—	0.5	—	0.5	—	ns
SLEEP MODE AND CONFIGURATION PARAMETERS										
t _{ZZPW}	ZZ Pulse Width	100	—	100	—	100	—	100	—	ns
t _{ZZR} ⁽³⁾	ZZ Recovery Time	100	—	100	—	100	—	100	—	ns
t _{CFG} ⁽⁴⁾	Configuration Set-up Time	34	—	40	—	50	—	50	—	ns

3619 tbl 15

NOTES:

1. Measured as HIGH above 2.0V and LOW below 0.8V.
2. Transition is measured ± 200 mV from steady-state.
3. Device must be deselected when powered-up from sleep mode.
4. t_{CFG} is the minimum time required to configure the device based on the $\overline{\text{LBO}}$ input. $\overline{\text{LBO}}$ is a static input and must not change during normal operation.
5. The 71V632SA4 speed grade corresponds to a t_{CD} of 4.5ns.
6. 0°C to +70°C temperature range only.

Timing Waveform of Pipelined Read Cycle^(1,2)

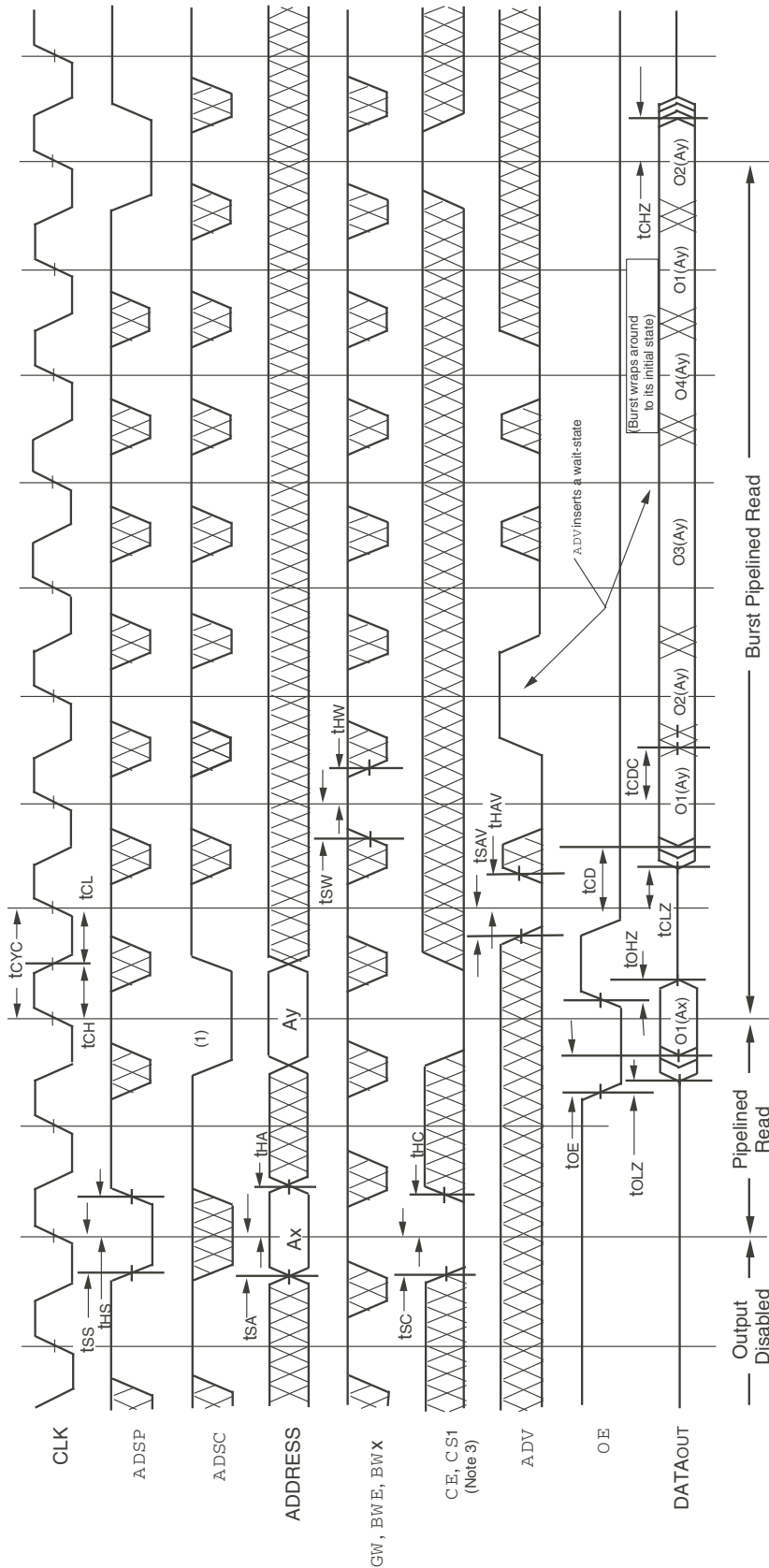

3619 drw 06

NOTES:

1. O1 (Ax) represents the first output from the external address Ax. O1 (Ay) represents the first output from the external address Ay. O2 (Ay) represents the next output data in the burst sequence of the base address Ay, etc. where Ax and Ay are advancing for the four word burst in the sequence defined by the state of the LBO input.
2. Zz input is LOW and LBO is Don't Care for this cycle.
3. CS0 limiting transitions are identical but inverted to the \overline{CE} and $\overline{CS1}$ signals. For example, when \overline{CE} and $\overline{CS1}$ are LOW on this waveform, CS0 is HIGH.

Timing Waveform of Combined Pipelined Read and Write Cycles^(1,2,3)

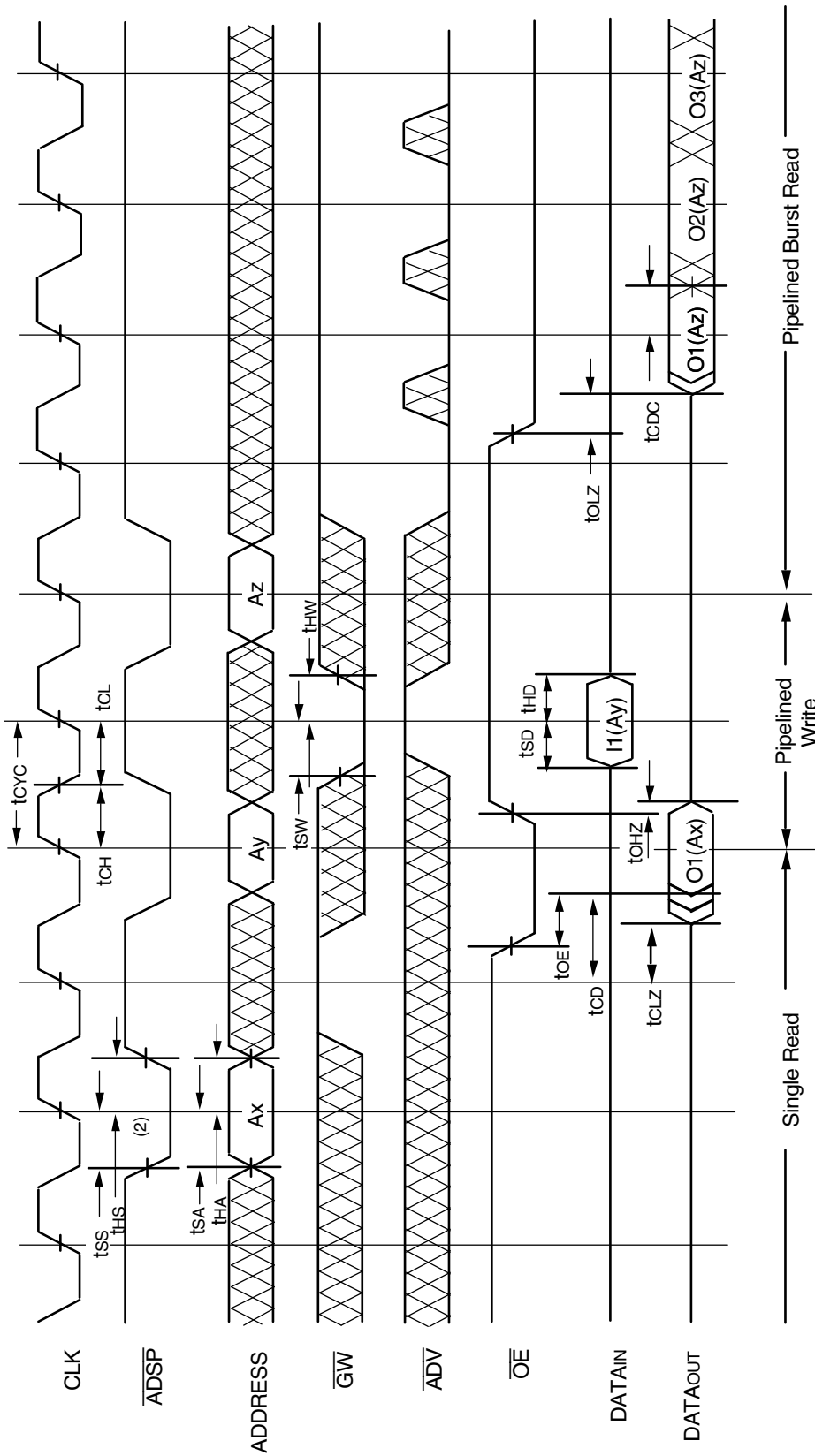

3619 d1w 07

NOTES:

1. Device is selected through entire cycle: \overline{CE} and $\overline{CS1}$ are LOW, $\overline{CS0}$ is HIGH.
2. ZZ input is LOW and LBO is Don't Care for this cycle.
3. O1(Ax) represents the first output from the external address Ax. I1 (Ay) represents the first input from the external address Ay. O1(Az) represents the first output from the external addresses Az; O2(Az) represents the next output data in the burst sequence of the base address Az, etc. where Ao and A1 are advancing for the four word burst in the sequence defined by the state of the LBO input.

Timing Waveform of Write Cycle No. 1 — **GW** Controlled^(1,2,3)

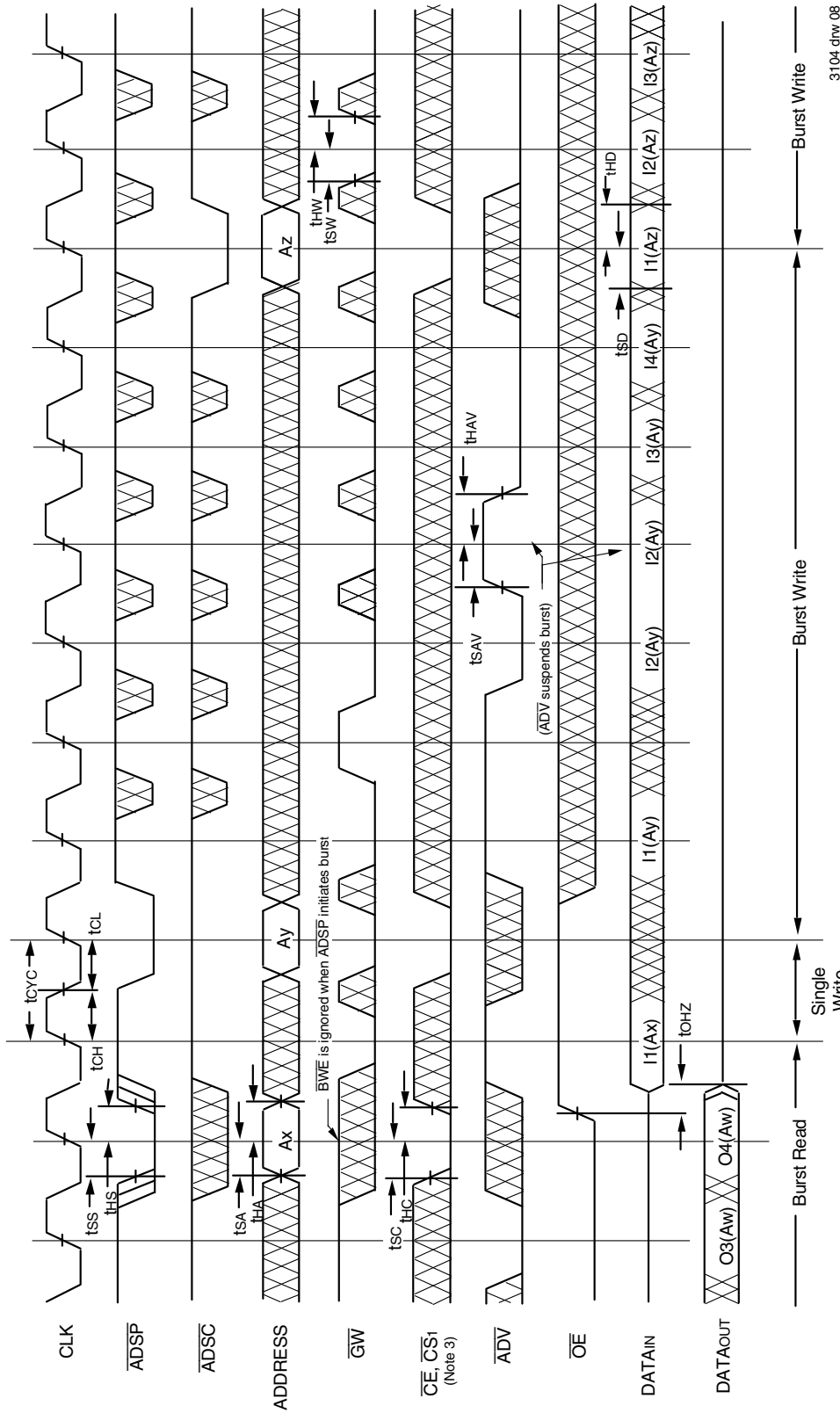

3104 drw 08

NOTES:

1. Z_Z input is LOW, \overline{BWE} is HIGH, and \overline{LBO} is Don't Care for this cycle.
2. O₄(Aw) represents the final output data in the burst sequence of the base address Aw. I₁(Ax) represents the first input from the external address Ax. I₁(Ay) represents the first input from the external address Ay. I₂(Ay) represents the next input data in the burst sequence of the base address Ay, etc. where A₀ and A₁ are advancing for the four word burst in the sequence defined by the state of the \overline{LBO} input. In the case of input I₂(Ay) this data is valid for two cycles because ADV is high and has suspended the burst.
3. CS₀ timing transitions are identical but inverted to the \overline{CE} and $\overline{CS_1}$ signals. For example, when \overline{CE} and $\overline{CS_1}$ are LOW on this waveform, CS₀ is HIGH.

Timing Waveform of Write Cycle No. 2 — Byte Controlled^(1,2,3)

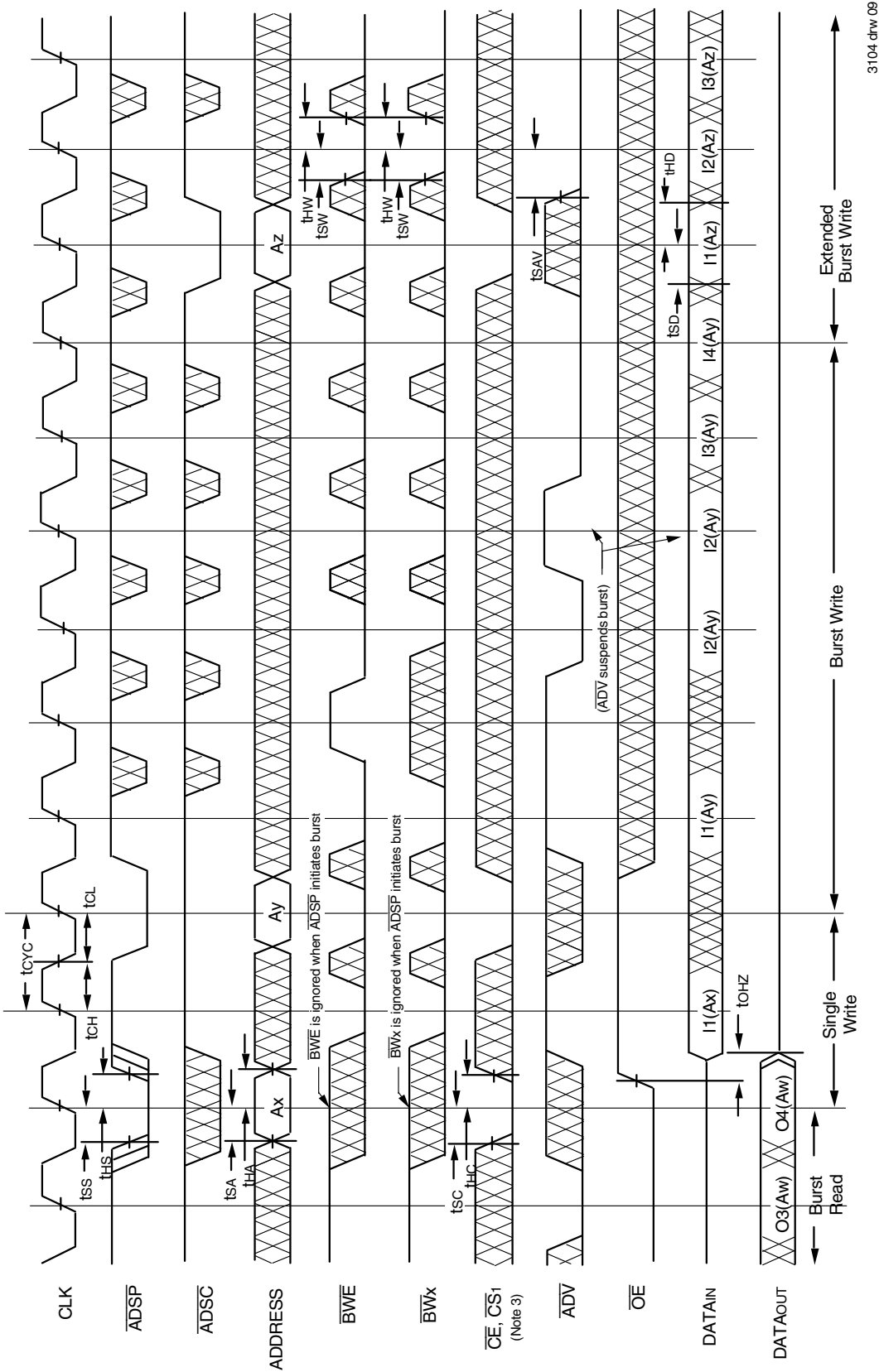

3104 drw 09

NOTES:

1. Z \bar{Z} input is LOW, $\overline{G\bar{W}}$ is HIGH, and $\overline{L\bar{B}\bar{O}}$ is Don't Care for this cycle.
2. O4(Aw) represents the final output data in the burst sequence of the base address Aw. I1(Ax) represents the first input from the external address Ay. I2(Ay) represents the next input data in the burst sequence of the base address Ay, etc. where A0 and A1 are advancing for the four word burst in the sequence defined by the state of the $\overline{L\bar{B}\bar{O}}$ input. In the case of input I2(Ay) this data is valid for two cycles because ADV is high and has suspended the burst.
3. CS0 limiting transitions are identical but inverted to the $\overline{C\bar{E}}$ and $\overline{C\bar{S}1}$ signals. For example, when $\overline{C\bar{E}}$ and $\overline{C\bar{S}1}$ are LOW on this waveform, CS0 is HIGH.

Timing Waveform of Sleep (ZZ) and Power-Down Modes^(1,2,3)

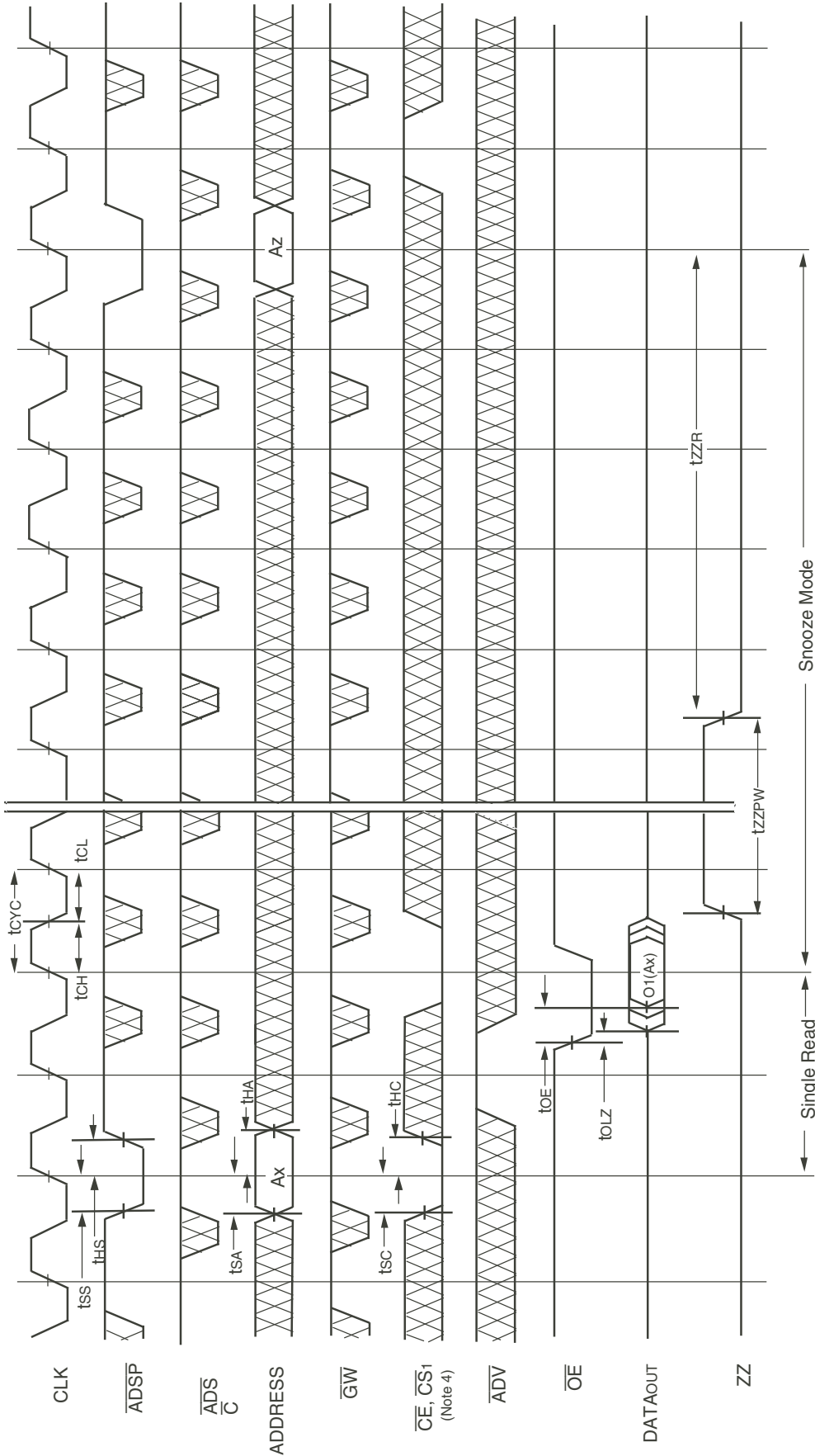

3104 drw 10

NOTES:

1. Device must power up in deselected Mode.
2. \overline{LBO} input is Don't Care for this cycle.
3. It is not necessary to retain the state of the input registers throughout the Power-down cycle.
4. CS0 limiting transitions are identical but inverted to the \overline{CE} and $\overline{CS1}$ signals. For example, when \overline{CE} and $\overline{CS1}$ are LOW on this waveform, CS0 is HIGH.

Non-Burst Read Cycle Timing Waveform

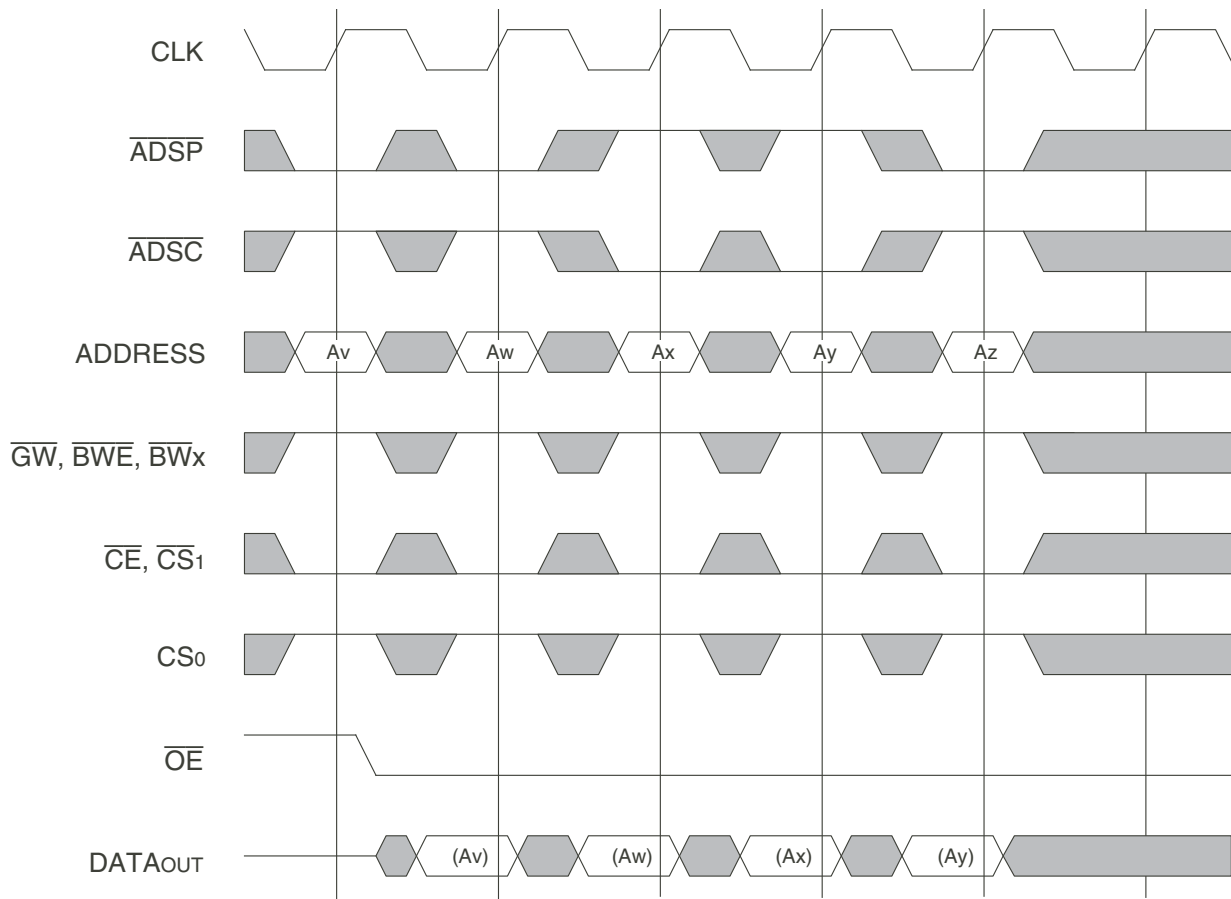

3619 drw 11

NOTES:

1. ZZ input is LOW, \overline{ADV} is HIGH and \overline{LBO} is Don't Care for this cycle.
2. (Ax) represents the data for address Ax, etc.
3. For read cycles, \overline{ADSP} and \overline{ADSC} function identically and are therefore interchangeable.

Non-Burst Write Cycle Timing Waveform

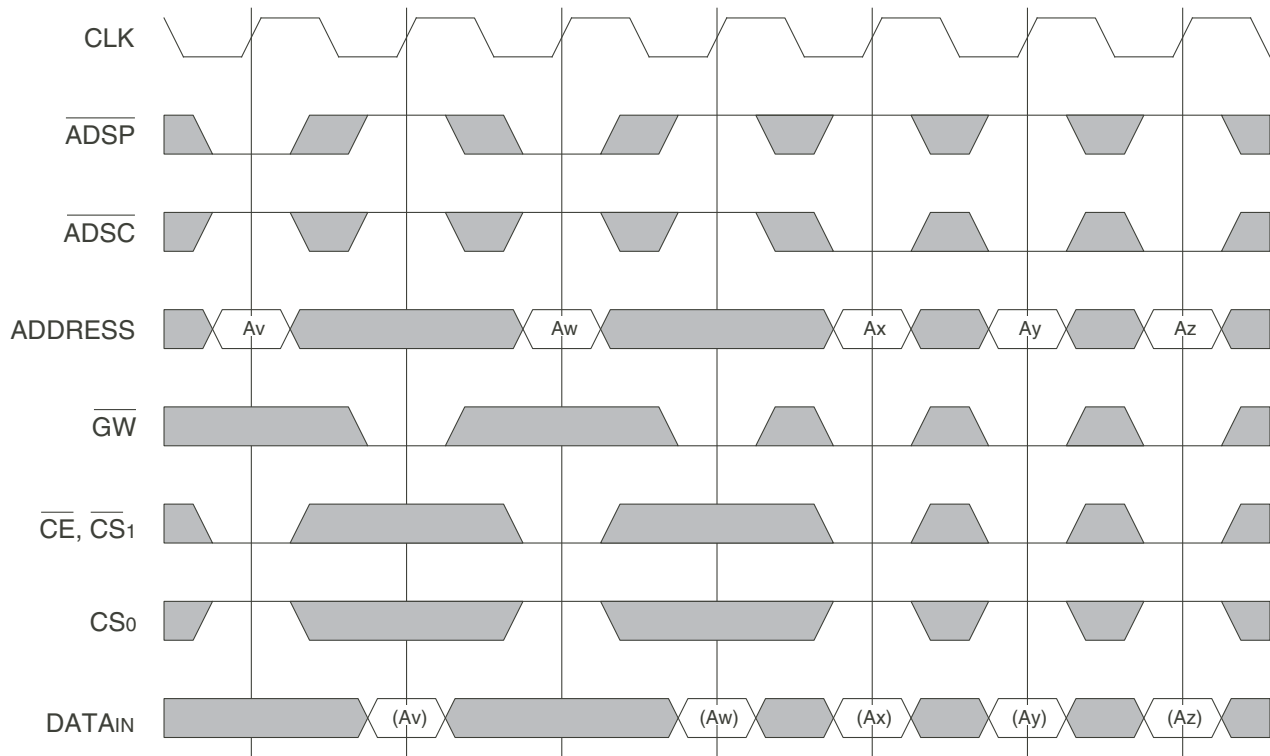

3619 drw 12

NOTES:

1. ZZ input is LOW, \overline{ADV} and \overline{OE} are HIGH, and $\overline{LB0}$ is Don't Care for this cycle.
2. (A_x) represents the data for address A_x , etc.
3. Although only \overline{GW} writes are shown, the functionality of \overline{BWE} and \overline{BWx} together is the same as \overline{GW} .
4. For write cycles, \overline{ADSP} and \overline{ADSC} have different limitations.

Ordering Information

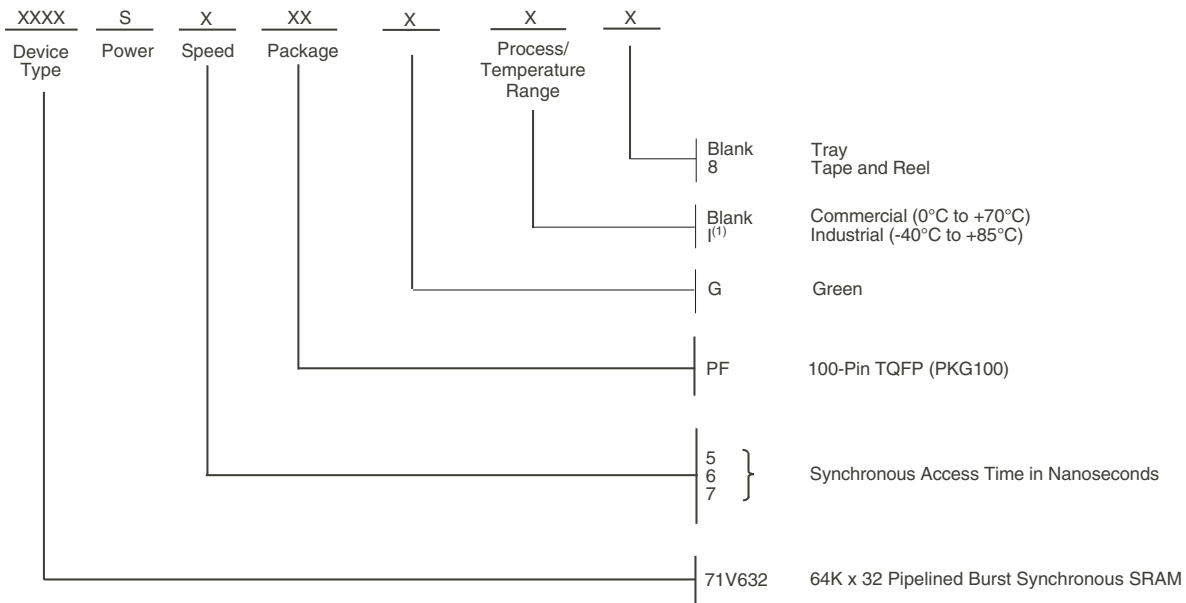

3619 drw 13

NOTES:

- Contact your local sales office for industrial temp range for other speeds, packages and powers.

Part Number	Speed in Megahertz	t _{cd} Parameter	Clock Cycle Time
71V632S5PF	100 MHz	5 ns	10 ns
71V632S6PF	83 MHz	6 ns	12 ns
71V632S7PF	66 MHz	7 ns	15 ns

3619 tbl 16

Orderable Part Information

Speed (ns)	Orderable Part ID	Pkg. Code	Pkg. Type	Temp. Grade
5	71V632S5PFGI	PKG100	TQFP	I
	71V632S5PFGI8	PKG100	TQFP	I
6	71V632S6PFGI	PKG100	TQFP	I
	71V632S6PFGI8	PKG100	TQFP	I
7	71V632S7PFG	PKG100	TQFP	C
	71V632S7PFG8	PKG100	TQFP	C
	71V632S7PFGI	PKG100	TQFP	I
	71V632S7PFGI8	PKG100	TQFP	I

Datasheet Document History

09/09/99		Updated to new format
	Pg. 1, 8, 9, 17	Revised speed offerings to 66–117MHz
	Pg. 15, 16	Added non-burst read and write cycle timing diagrams
	Pg. 18	Added Datasheet Document History
09/30/99	Pg. 1, 4, 8, 9, 17	Added industrial temperature range offerings
04/04/00	Pg. 17	Added 100pinTQFP package Diagram Outline
08/09/00		Not recommended for new designs
08/17/01		Removed "Not recommended for new designs" from the background on the datasheet
02/28/07	Pg. 18	Added Z generation die step to data sheet ordering information.
10/16/08	Pg. 18	Removed "IDT" from orderable part number.
05/27/10	Pg. 17	Added "Restricted hazardous substance device" to the ordering information
02/24/17	Pg. 1	Removed Z from device part number
		Added green availability to features
	Pg. 5	Update PK100-1 to package code PKG100 and restore overbars
	Pg. 14	Restored Sleep (ZZ) Timing Waveform
	Pg. 16	Restored Non-Burst Write Cycle Timing Waveform
		Removed PSC Package Diagram
	Pg. 17	Restored Ordering Information: Added Green, Tape & Reel, Tray and footnote indicators
		Removed Z Die Stepping indicator in Ordering Information
03/09/20	Pg. 1 - 19	Rebranded as Renesas datasheet
	Pg. 1 - 2	Corrected typos
	Pg. 1 & 17	Deleted obsolete A4 speed grade
	Pg. 17	Added Orderable Part Information table
03/04/22		71V632 Datasheet changed to Obsolete Status

IMPORTANT NOTICE AND DISCLAIMER

RENESAS ELECTRONICS CORPORATION AND ITS SUBSIDIARIES (“RENESAS”) PROVIDES TECHNICAL SPECIFICATIONS AND RELIABILITY DATA (INCLUDING DATASHEETS), DESIGN RESOURCES (INCLUDING REFERENCE DESIGNS), APPLICATION OR OTHER DESIGN ADVICE, WEB TOOLS, SAFETY INFORMATION, AND OTHER RESOURCES “AS IS” AND WITH ALL FAULTS, AND DISCLAIMS ALL WARRANTIES, EXPRESS OR IMPLIED, INCLUDING, WITHOUT LIMITATION, ANY IMPLIED WARRANTIES OF MERCHANTABILITY, FITNESS FOR A PARTICULAR PURPOSE, OR NON-INFRINGEMENT OF THIRD-PARTY INTELLECTUAL PROPERTY RIGHTS.

These resources are intended for developers who are designing with Renesas products. You are solely responsible for (1) selecting the appropriate products for your application, (2) designing, validating, and testing your application, and (3) ensuring your application meets applicable standards, and any other safety, security, or other requirements. These resources are subject to change without notice. Renesas grants you permission to use these resources only to develop an application that uses Renesas products. Other reproduction or use of these resources is strictly prohibited. No license is granted to any other Renesas intellectual property or to any third-party intellectual property. Renesas disclaims responsibility for, and you will fully indemnify Renesas and its representatives against, any claims, damages, costs, losses, or liabilities arising from your use of these resources. Renesas' products are provided only subject to Renesas' Terms and Conditions of Sale or other applicable terms agreed to in writing. No use of any Renesas resources expands or otherwise alters any applicable warranties or warranty disclaimers for these products.

(Disclaimer Rev.1.01 Jan 2024)

Corporate Headquarters

TOYOSU FORESIA, 3-2-24 Toyosu,
Koto-ku, Tokyo 135-0061, Japan
www.renesas.com

Trademarks

Renesas and the Renesas logo are trademarks of Renesas Electronics Corporation. All trademarks and registered trademarks are the property of their respective owners.

Contact Information

For further information on a product, technology, the most up-to-date version of a document, or your nearest sales office, please visit www.renesas.com/contact-us/.

Looking for pricing, stock, or lifecycle information?

Click below to explore more details on WIN SOURCE:

- ⊖ [View 71V632S5PFG8 on WIN SOURCE](#)
- ⊖ [Renesas Electronics America](#) Information

Optimize Your Supply Chain with WIN SOURCE Solutions

- ✓ Global Sourcing Solution
- ✓ Obsolete Management
- ✓ Cost Control Management
- ✓ Shortage Management
- ✓ Alternative Solution
- ✓ Excess Inventory Management