



**THE DATASHEET OF  
70HFR160**





# PACKAGE MECHANICAL DATA

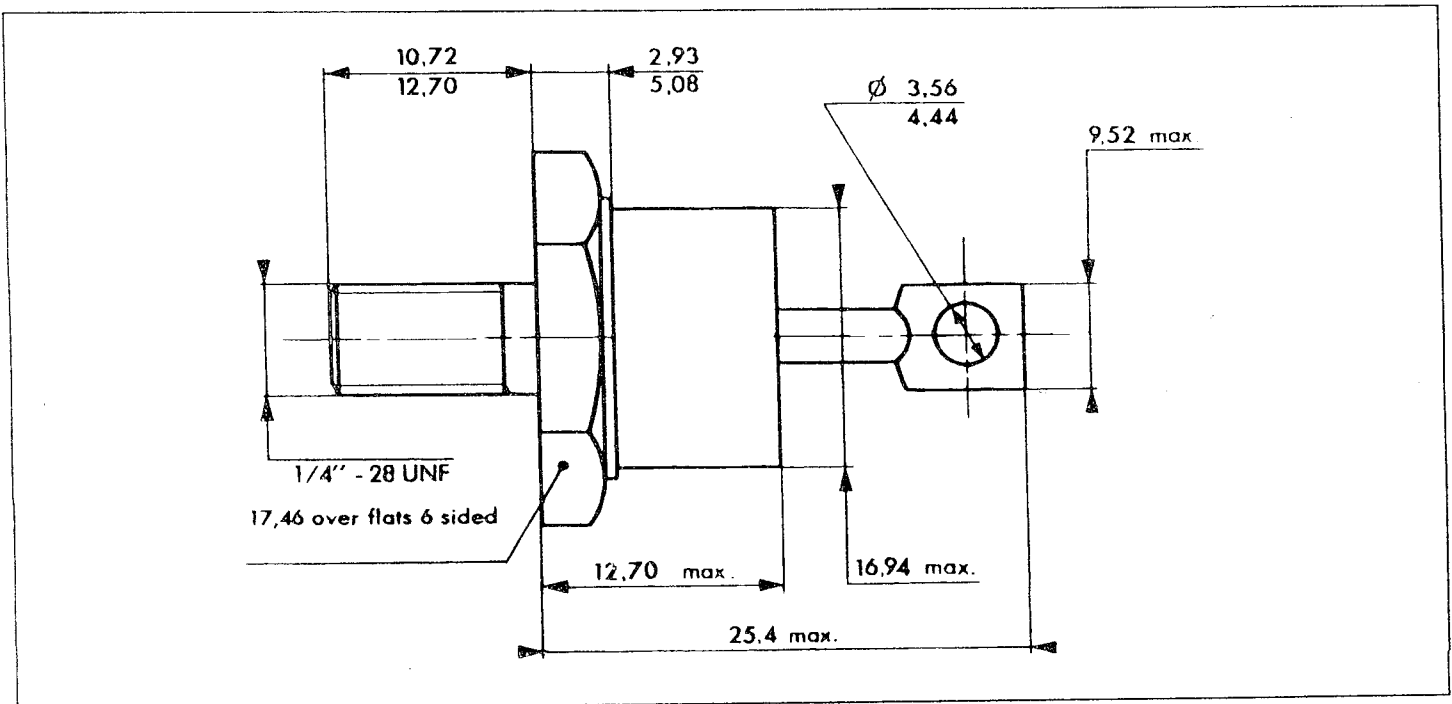

DO 5 Metal



Marking : Cathode connected to case : type number  
Anode connected to case : type number + suffix R

## Looking for pricing, stock, or lifecycle information?

Click below to explore more details on WIN SOURCE:

-  [View 70HFR160 on WIN SOURCE](#)
-  [Solid State Inc. Information](#)

## Optimize Your Supply Chain with WIN SOURCE Solutions

-  Global Sourcing Solution
-  Obsolete Management
-  Cost Control Management
-  Shortage Management
-  Alternative Solution
-  Excess Inventory Management