



**THE DATASHEET OF  
691701320010B**



1

2

3

4

5

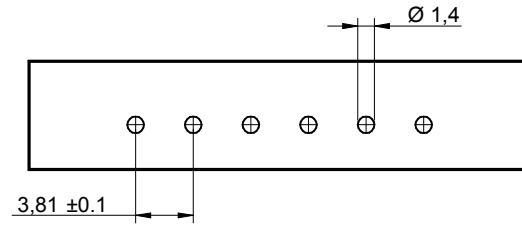

RECOMMENDED PCB LAYOUT - COMPONENT VIEW

## CHARACTERISTICS

## MATERIAL

Insulator material : LCP  
 Flammability rating : UL94-V0  
 Colour : Black  
 Contact pin : Brass (CuZn)  
 Surface of solder tail plating : Tin Plated  
 Flange nut : Brass - M2.5

## ENVIRONMENTAL

Operating temperature : -40°C up to 105°C  
 Compliance : Lead free and RoHS

## SOLDERING

Solder temperature : Reflow process as per JEDEC J-020D-STD

## ELECTRICAL

Current rating : 10A  
 Working voltage : 300 Vac  
 Dielectric withstanding voltage : 2.5 kVac/min  
 Contact resistance : 20 mΩ max

## STANDARD

 Certified : E315414 / Model number 7013

## MECHANICAL

Pitch : 3.81mm

## PACKAGING

Tape & Reel with cap

Poles	A	B
2	3.81	18.01
3	7.62	21.82
4	11.43	25.63
5	15.24	29.44
6	19.05	33.25
7	22.86	37.06
8	26.67	40.87
9	30.48	44.68
10	34.29	48.49
11	38.1	52.3
12	41.91	56.11

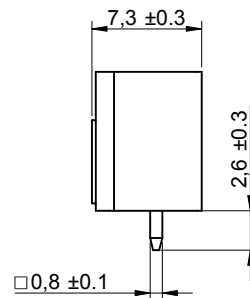
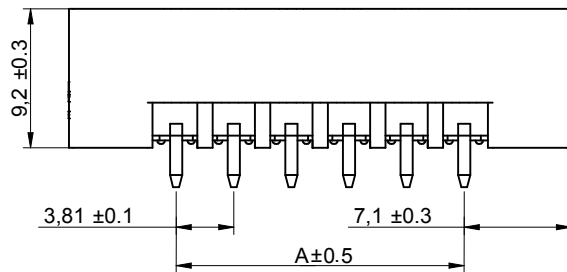
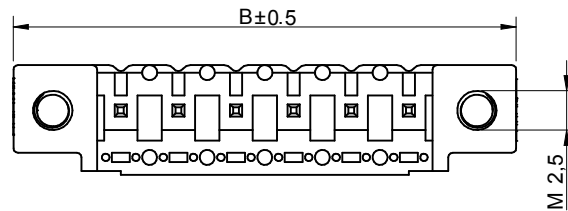

RoHS Compliant

G			
F			
E			
D			
C	29-JUL-13	DWG REVIEW	QL
B	19-DEC-11	6917013200xx	QL
A	14-SEP-11	PDF	QL
REV	DATE	FILE	BY

PROJECTION:

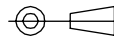

APPROVAL: RJ

GENERAL TOLERANCE

.X = +/- 0.2

.XX = +/- 0.15

UNIT: MM

SCALE: 2/1

SHEET: 1/2

DRAW: QUENTIN



WÜRTH ELEKTRONIK

DESCRIPTION: SERIE 7013B - 3.81MM VERTICAL PCB HEADER - THR TYPE WITH FLANGES

WERI PART NO: 691 701 320 0xx B

SIZE

A4

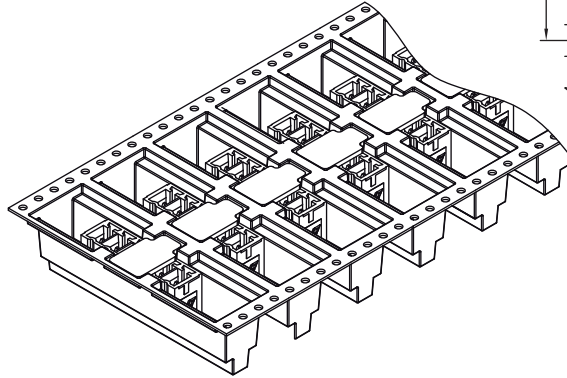
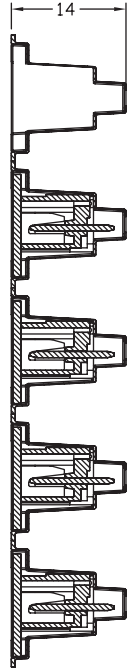
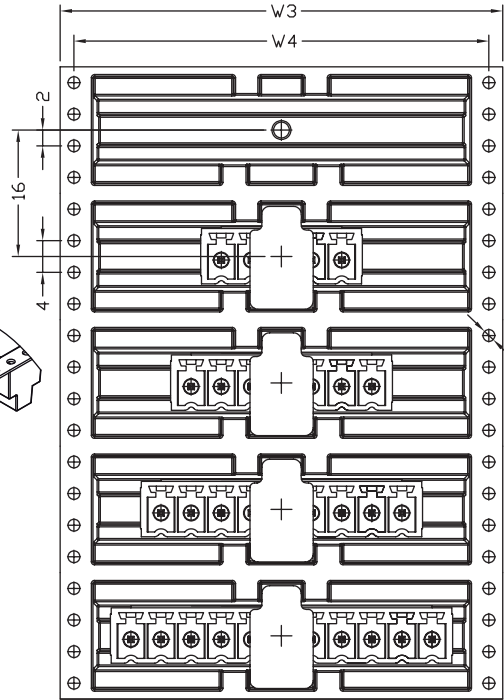
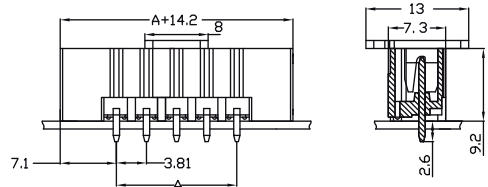
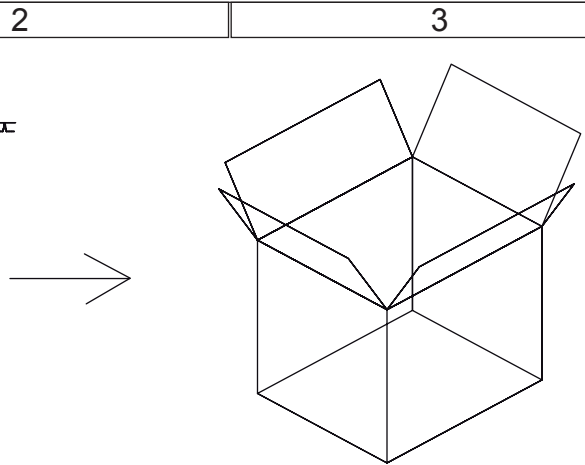
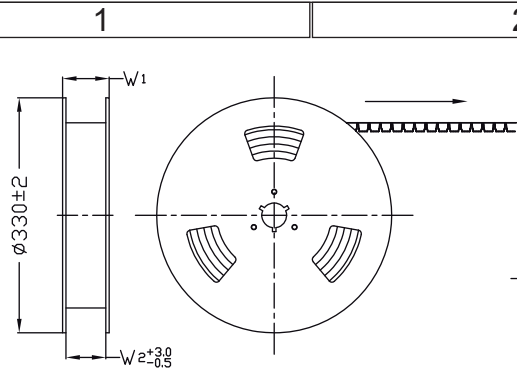

1. 10 sprocket hole pitch cumulative tolerance  $\pm 0.20$
2. Carrier camber is within 1 mm in 250 mm.
3. Material : Black Conductive Polystyrene Alloy.  
Transparent anti-static PET
4. All dimensions meet EIA-481-C requirements.
5. Thickness :  $0.50 \pm 0.05$  mm.
6. Component load per 13" reel : 250 pcs.

Poles	A	Dimension				Reel / carton	Carton dimensions (cm)	Quantity / Carton
		W1(mm)	W2(mm)	W3(mm)	W4(mm)			
2	3.81	36.4	32	32	28.4	10	33.5 x 33.5 x 40	2500
3	7.62	60.4	56	56	52.5	6	33.5 x 33.5 x 40	1500
4	11.43	60.4	56	56	52.5	6	33.5 x 33.5 x 40	1500
5	15.24	60.4	56	56	52.5	6	33.5 x 33.5 x 40	1500
6	19.05	60.4	56	56	52.5	6	33.5 x 33.5 x 40	1500
7	22.86	60.4	56	56	52.5	6	33.5 x 33.5 x 40	1500
8	26.67	60.4	56	56	52.5	6	33.5 x 33.5 x 40	1500
9	30.48	76.4	72	72	68.5	5	33.5 x 33.5 x 40	1250
10	34.29	76.4	72	72	68.5	5	33.5 x 33.5 x 40	1250
11	38.1	76.4	72	72	68.5	5	33.5 x 33.5 x 40	1250
12	41.91	76.4	72	72	68.5	5	33.5 x 33.5 x 40	1250

RoHS Compliant			
G			
F			
E			
D			
C			
B			
A			
REV	DATE	FILE	BY

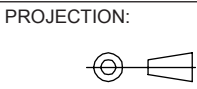

GENERAL TOLERANCE  
 .X =  $\pm 0.2$   
 .XX =  $\pm 0.15$

APPROVAL: RJ

UNIT: MM  
 SCALE:  
 SHEET: 2/2  
 DRAW: QUENTIN



DESCRIPTION: SERIE 7013B - 3.81MM VERTICAL PCB HEADER - THR TYPE WITH FLANGES  
 WERI PART NO: 691 701 320 0xx B

SIZE  
**A4**

## Looking for pricing, stock, or lifecycle information?

Click below to explore more details on WIN SOURCE:

 [View 691701320010B on WIN SOURCE](#)

 [Wurth Electronics Inc Information](#)

## Optimize Your Supply Chain with WIN SOURCE Solutions

-  Global Sourcing Solution
-  Obsolete Management
-  Cost Control Management
-  Shortage Management
-  Alternative Solution
-  Excess Inventory Management