

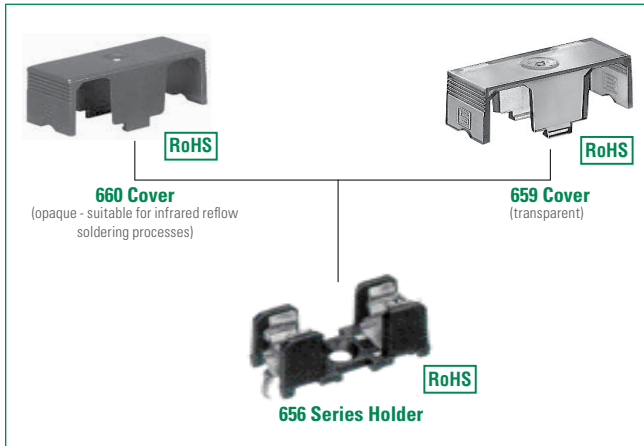

THE DATASHEET OF
66000001009



656 Series Molded Base PC Mount Fuse Block For 5x20mm Fuses



Agency Approval

Agency	Agency File Number
	40001499
	E70164

Additional Information



Datasheet



Resources



Samples

Dimensions

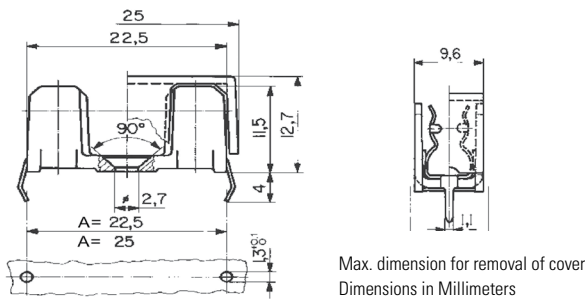

Product Characteristics

Compatible Fuse Size	5x20mm
Materials	Holder: Black Thermoplastic UL94 V-0 Metal Parts: Tin plated copper alloy
Electrical Data	Rated Voltage: VDE 250 VAC UL 500 VAC/DC Rated Current: 16 A (UL)/10 A (VDE) Rated Power Acceptance (at ambient air temp 23 °C): - 4 W without cover - 4 W with 660 cover - 2.5 W with 659 cover
Mounting	656: Solder pins 0.4mmx1.1mm Ø 2.7mm screw hole may be used optionally
Operating Temperature	-40 °C to +85 °C
Climatic Category	40/085/21 according to IEC 60068-1
Stock Conditions	0 °C to 60 °C, at max. 70% relative humidity
Vibration Resistance	According to IEC 60068-2-6, Test Fc
Contact Resistance	<5 mΩ
Dielectric Strength	> 3 kV, 50 Hz, 1 min.
Impulse withstand Voltage	> 4 kV between live parts
Insulation Resistance	(500 V DC/1 min): >10 MΩ between live parts of different potentials
Solderability	245 °C/3 sec. according to IEC 60068-2-20, Test Ta, method 1
Soldering Heat Resistance	260 °C/10 sec. according to IEC 60068-2-20, test Tb method 1
Minimum Cross Section	Conducting path - 0.2 mm ²
Torque/fixing screw	Max. 0.3 Nm

Note: If used with covers, refer to [Fuseology](#) for information on proper fuse block re-rating.

Re-rating Curves

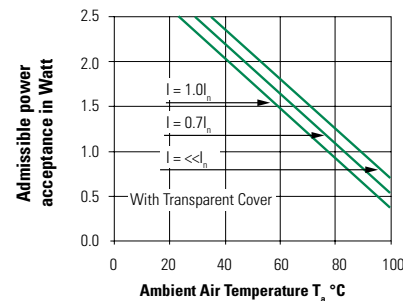
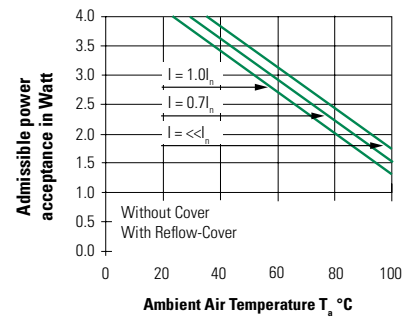

Soldering Parameters—Wave Soldering

Wave Parameter	Lead-Free Recommendation
Preheat: (Depends on Flex Activation Temperature)	(Typical Industry Recommendation)
Temperature Minimum	100 °C
Temperature Maximum	150 °C
Preheat Time	60–180 seconds
Solder Pot Temperature	260 °C Maximum
Solder Dwell Time	2–5 seconds

Recommended Hand-Solder Parameters:
 Solder Iron Temperature: 350 °C +/- 5 °C
 Heating Time: 5 seconds max.

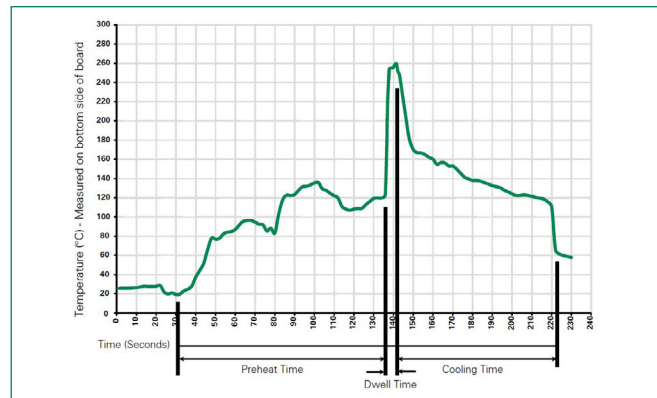

Ordering Information

Part Number	Description	Packaging
65600001009	Fuse Block - "A" dimension 22.5mm	Bulk Pack (100 Pcs)
65600001409	Fuse Block - "A" dimension 25mm	Bulk Pack (100 Pcs)
65900000009	Fuse Holder Cover - Transparent plastic	Bulk Pack (100 Pcs)
66000001009	Fuse Holder Cover - Opaque plastic, suitable for infrared (IR) reflow soldering process	Bulk Pack (100 Pcs)

Looking for pricing, stock, or lifecycle information?

Click below to explore more details on WIN SOURCE:

 [View 66000001009 on WIN SOURCE](#)

 [Littelfuse Inc. Information](#)

Optimize Your Supply Chain with WIN SOURCE Solutions

-  Global Sourcing Solution
-  Obsolete Management
-  Cost Control Management
-  Shortage Management
-  Alternative Solution
-  Excess Inventory Management