



**THE DATASHEET OF**  
**61032021121**



1

2

3

4

5

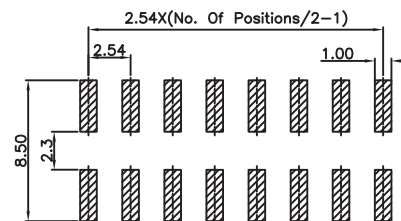

PCB LAYOUT - COMPONENT VIEW

## TECHNICAL CHARACTERISTICS

MATERIAL  
 INSULATOR: PA 6T  
 FLAMMABILITY RATING: UL94-V0  
 COLOR: BLACK  
 CONTACT MATERIAL: COPPER ALLOY  
 CONTACT TYPE: STAMPED  
 CONTACT PLATING: GOLD  
 QUALITY CLASS: 3 AS PER CECC 75 301-802  
 PITCH: 2.54 MM

## ENVIRONMENTAL

OPERATING TEMPERATURE: -40 UP TO 125°C  
 COMPLIANCE: LEAD FREE AND ROHS

## ELECTRICAL

CURRENT RATING: 3A  
 WORKING VOLTAGE: 250 VAC  
 INSULATOR RESISTANCE: >1000 MOHM  
 DIELECTRIC WITHSTANDING VOLTAGE: 500 VAC/MN  
 CONTACT RESISTANCE: 20 mOHM MAX

## STANDARD

 CERTIFIED: E323964

## SOLDERING

JEDEC LEAD FREE REFLOW SOLDERING

## PACKAGING

TAPE & REEL WITH CAP



## DIMENSION

A = 2.54x (NB. PIN / 2 - 1)

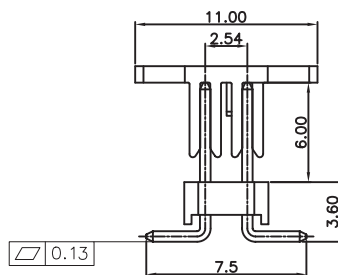
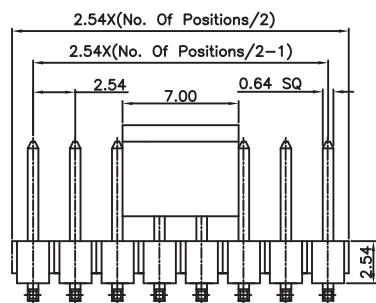
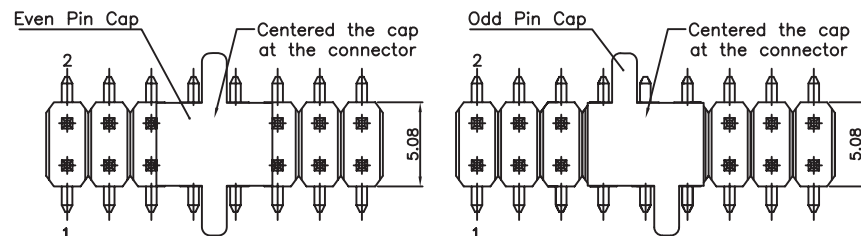
B = 2.54x (NB. PIN / 2)

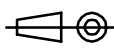

RoHS Compliant

RoHS Compliant				PROJECTION:	GENERAL TOLERANCE		DESCRIPTION: 2.54MM DUAL SMT PIN HEADER	SIZE
G					.X = +/- 0.2			
F	10-JAN-17	UPDATE	AK		.XX = +/- 0.15			
E	04-MAR-13	DRAWING	QL					
D	29-JUL-09	PACKAGING	JP					
C	09-NOV-07	PAGE 2	CH		APPROVAL: GMo	UNIT: MM		
B	25-OCT-07	PAD SIZE	EC			SCALE:		
A	29-DEC-06	PDF	JP		SHEET: 1/3			
REV	DATE	FILE	BY		DRAW: MARY			

A

B

C

D

1

2

3

4

5

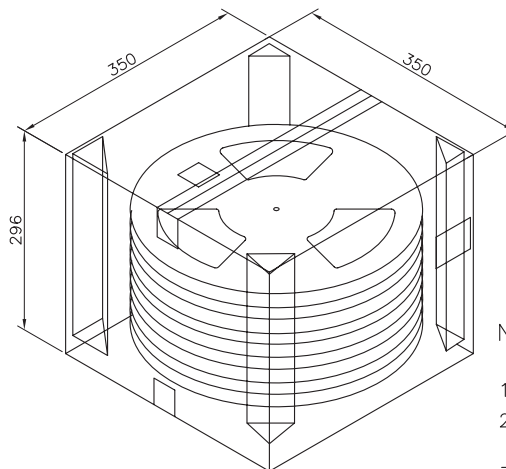
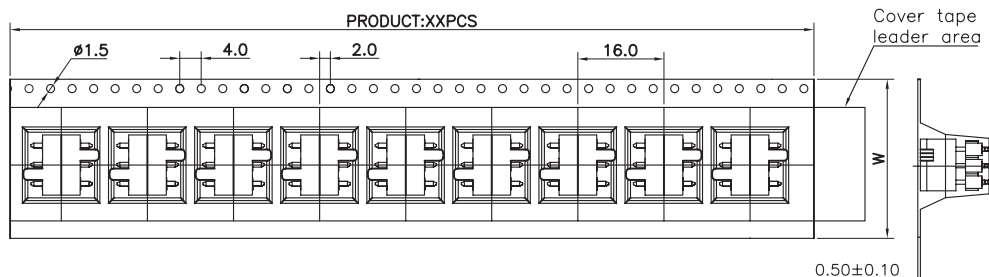
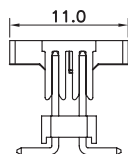
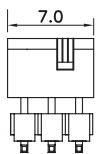
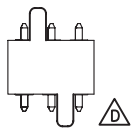

Note:

- 1.All dimensions meet EIA-481-3 requirements.
- 2.Material : Black Conductive Polystyrene Alloy  
100% recyclable.
- 3.Thickness : 0.50±0.05mm
- 4.Component load per 13" reel :300 pcs.
- 5.Cartan Size:350\*350\*296(MM)
- 6.W ≤ 24, Single Row Hole.  
W > 24, Double Rows Hole
- 7.Apply to Product:  
2213SM-XXX-BK-CR,2213SM-XXX-CR  
2213SM-XXG30-CR

Pin No	W	A	PCS/R	R/CTN	Q'TY
04-08	24	29	300	9	2700
10-14	32	37	300	7	2100
16-24	44	49	300	5	1500
26-32	56	61	300	4	1200
34-44	72	77	300	3	900

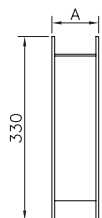

Feeding direction

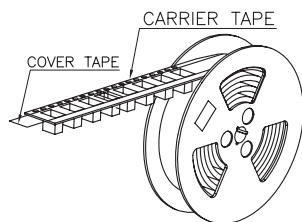
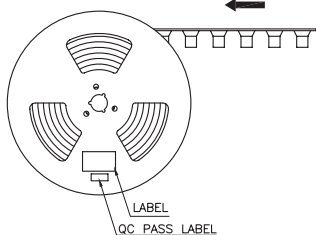

RoHS Compliant

PROJECTION:



GENERAL TOLERANCE

.X =  $\pm 0.2$ .XX =  $\pm 0.15$ 

APPROVAL: GMo

UNIT: MM

DESCRIPTION: 2.54MM DUAL SMT PIN HEADER

SIZE

SCALE:

WERI PART NO: 610 3xx 211 21

A4

SHEET: 2/3

DRAW: MARY

REV	DATE	FILE	BY
A	21-MAR-13	UPDATE	AR

1

2

3

4

5

## Cautions and Warnings:

This electronic component is designed and developed with the intention for use in general electronics equipments.

Before incorporating the components into any equipments in the field such as aerospace, aviation, nuclear control, submarine, transportation, (automotive control, train control, ship control), transportation signal, disaster prevention, medical, public information network etc. where higher safety and reliability are especially required or if there is possibility of direct damage or injury to human body, Würth Elektronik must be asked for a written approval.



In addition, even electronic component in general electronic equipments, when used in electrical circuits that require high safety, reliability functions or performance, the sufficient reliability evaluation-check for the safety must be performed before by the user before usage.

A

B

C

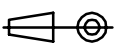
RoHS Compliant

G				PROJECTION: 	GENERAL TOLERANCE .X = +/- 0.2 .XX = +/- 0.15		
F							
E							
D							
C				APPROVAL: JC	UNIT: MM	DESCRIPTION: DISCLAIMER	SIZE <b>A4</b>
B					SCALE:		
A	10-SEP-14	PDF	QL		SHEET: 3/3	WERI PART NO: DISCLAIMER	
REV	DATE	FILE	BY		DRAW: QL		

D

## Looking for pricing, stock, or lifecycle information?

Click below to explore more details on WIN SOURCE:

 [View 61032021121 on WIN SOURCE](#)

 [Wurth Electronics Inc Information](#)

## Optimize Your Supply Chain with WIN SOURCE Solutions

-  Global Sourcing Solution
-  Obsolete Management
-  Cost Control Management
-  Shortage Management
-  Alternative Solution
-  Excess Inventory Management