



**THE DATASHEET OF
145863060024829+**



0.35mm Pitch
Board to Board Connector

5863 Series

シリーズ (Series)	5863
基板間高さ (Stacking Height)	0.8mm
極間隔 (Pitch)	0.35mm
極数 (No. of Positions)	40 to 60 Pos.
定格電流 (Rated Current)	DC 0.3A/Contact DC 5.0A/Metal tab
定格電圧 (Rated Voltage)	DC 60V/Contact
耐電圧 (D. W. Voltage)	AC 250Vrms/min.
コンタクト材質 (Contact Material)	銅合金 (Copper alloy)
インシュレータ材質 (Insulator Material)	耐熱樹脂 (Heat-resistant plastic)
使用温度範囲 (Operating Temperature)	-40 to +85°C



◆概要

5863 シリーズは、0.35mm ピッチの狭ピッチ基板対基板用コネクタで、嵌合（基板間）高さ 0.8mm、奥行き寸法 2.3mm の省スペース製品です。狭ピッチ・低背製品でありながら、両端を金具で覆うことにより、嵌合時の位置ずれによるインシュレータやコンタクトの破損を防ぎ、高い堅牢性と滑らかな嵌合誘い込みを実現したコネクタです。また、両端の金具は定格電流 5.0A/ 金具で高電流通電が可能です。

◆Outline

The 5863 Series are space-saving Board to Board Connectors featuring a fine pitch of 0.35mm, stacking height of 0.8mm (between boards) and a width of 2.3mm. With the metals covering both ends, the connector, with narrow pitches and low profile though, realizes the structurally high robustness and smooth guiding function for mating to prevent breakage of the insulator housing and contact caused by misaligned mating. The metals at both ends of which rated current is 5.0A/metal tab enable to carry a large current.

◆特長

- (1) 上面を金具で覆うことで狭ピッチ、低背化に伴い生じる強度の低下を補強し、嵌合時の位置ずれによる破損を防ぎます。また、金具で覆われた上面のフラットな形状は、滑らかな誘い込みを実現し、嵌合を容易にします。
- (2) 0.35mm ピッチ・嵌合（基板間）高さ 0.8mm・製品幅 2.3mm の省スペース型コネクタ。
- (3) 固定金具を電源コンタクト（定格電流：5.0A）として使用可能です。
- (4) 接点部は、「挟み込み接点形状」（2点接点）を採用し、振動や落下衝撃などに強い構造となっています。また、プラグコンタクトの形状は、集中荷重を上げて異物を排除（ワイピング効果）する機構を施し、高い接触信頼性を実現しています。
- (5) 15,000 個入りのエンボステープ梱包でお届けします。
- (6) 環境に優しい RoHS 指令対応品です。

◆Features

- (1) High robustness and structure for smooth mating with top face covered by metals.
- (2) Space-saving connector with a fine pitch of 0.35mm, stacking height of 0.8mm, and width of 2.3mm.
- (3) Anchoring metal tabs are available for power connection with a rated current of 5.0A.
- (4) A pinching structure (two-point contact design), which is highly resistant to vibration and drop shocks, has been adopted for the contact structure. Furthermore, the plug contacts have an original structure featuring a wiping effect which eliminates foreign matter with concentrated load, thus realizing high contact reliability.
- (5) Packaged in tape and reel: 15,000 pieces/reel.
- (6) RoHS compliant product.

0.35mm Pitch 5863 Series

0.35mm ピッチ 嵌合高さ 0.8mm 金具付き SMT
 0.35mm Pitch, Stacking Height=0.8mm, With Metal tabs, SMT

● Plug

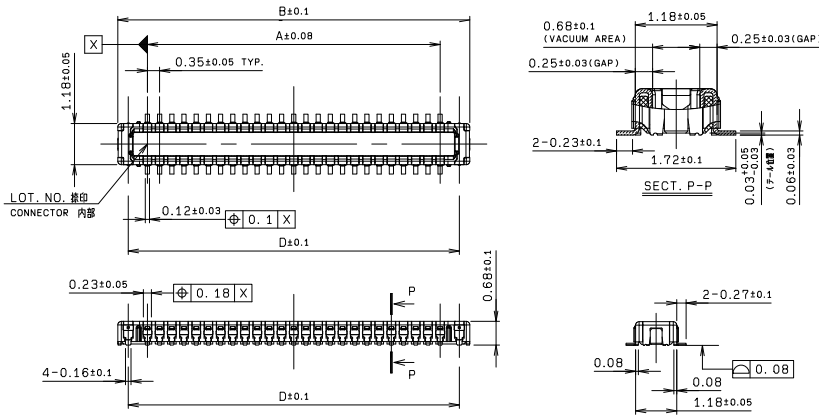

MATING CONDITION

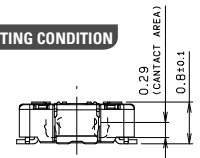

MATING CONDITION

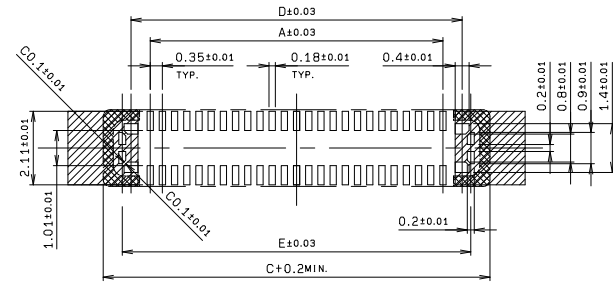

MOUNTING LAYOUT

⊠ : 絶縁エリア
INSULATION AREA

● Receptacle

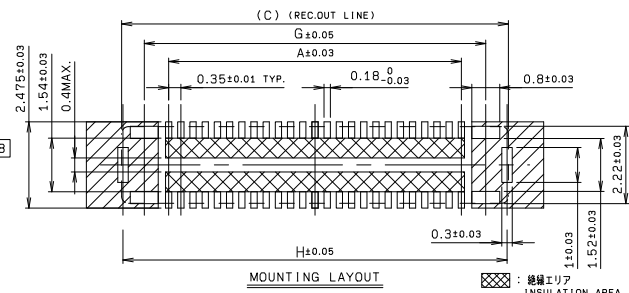
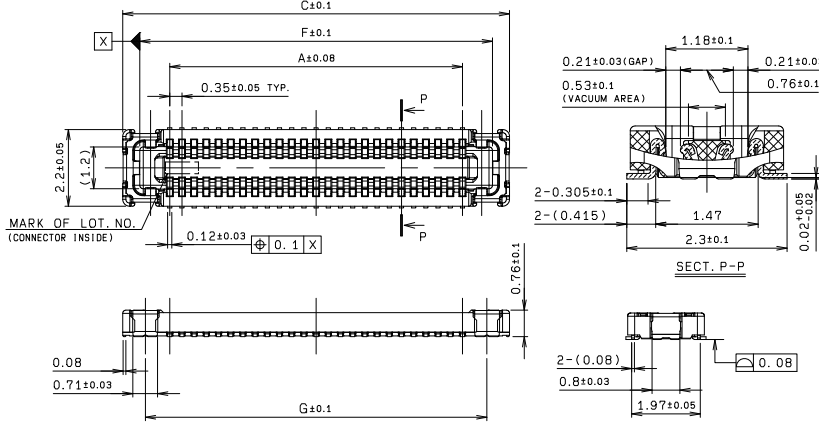

MOUNTING LAYOUT

⊠ : 絶縁エリア
INSULATION AREA

● Packaging

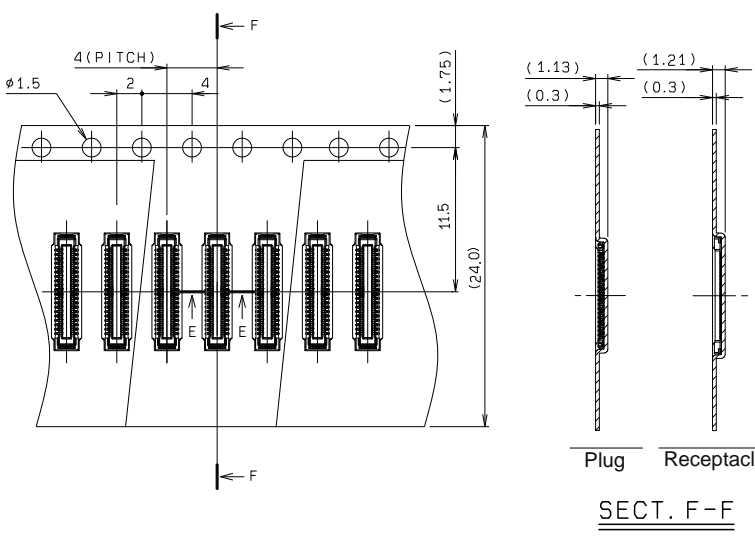

極数 NO. OF POS.	A	B	C	D	E	F	G	H
40	6.65	8.35	9.35	7.75	8.25	8.37	8.05	9.27
50	8.4	10.1	11.1	9.5	10.0	10.12	9.8	11.02
60	10.15	11.85	12.85	11.25	11.75	11.87	11.55	12.77

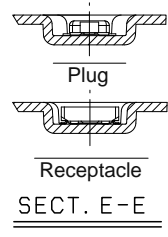

注文コード/Ordering Code

Plug
Part No. 14 5863 0XX 024 829+
 極数 No. of Pos.
 Receptacle
Part No. 24 5863 0XX 104 829+
 極数 No. of Pos.

RoHS 対応品
 RoHS Compliant Product

梱包数量 : 15,000 個 / リール
 PACKING QUANTITY: 15,000/Reel

本カタログには推奨めっきを掲載しております。めっき種類・仕様、ならびに生産対応可能極数については営業部にご確認願います。
 Recommended plating types are mentioned in this catalog. For other plating types and their specifications, and available numbers of positions, please feel free to contact our sales department.

Looking for pricing, stock, or lifecycle information?

Click below to explore more details on WIN SOURCE:

-  [View 145863060024829+ on WIN SOURCE](#)
-  [AVX Corp/Kyocera Corp Information](#)

Optimize Your Supply Chain with WIN SOURCE Solutions

-  Global Sourcing Solution
-  Obsolete Management
-  Cost Control Management
-  Shortage Management
-  Alternative Solution
-  Excess Inventory Management