



**THE DATASHEET OF
SBH31-NBPB-D05-ST-BK**





.050" [1.27 mm] Contact Centers, Shrouded (Box) Headers/Straight/Right Angle/SMT With or Without Post- SBH Series Mates with SFH31 series (See opposite page)

SPECIFICATIONS

- Polarizing Notch
- Operating Temperature: -40°C to +105°C
- Processing Temperature: 230°C Max. for 60 seconds, (260°C Max. for 10 seconds)
- UL Flammability Rating: 94V-0
- Contact Resistance: 20 milli Ohms Max.
- Current Rating: 1 Amp
- Dielectric Withstanding: 500 VAC
- Insulation Resistance: 5000 Megohms

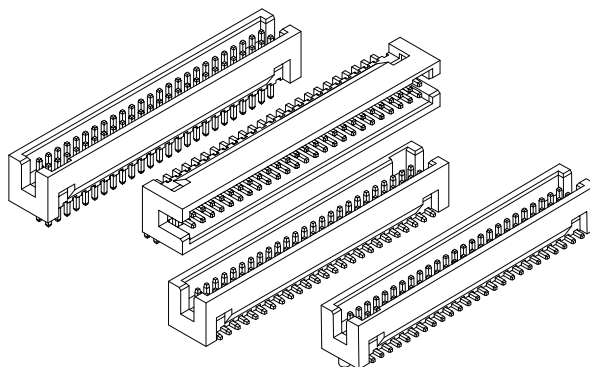

PART NUMBER OPTIONS

SERIES ————— **SBH31 - N B P B - D 10 - ST - BK**

SBH31 = Box Header, .050" [1.27 mm] Contact Centers by .050" [1.27 mm] Row Spacing

INSULATOR MATERIAL —————

N = Nylon
L = LCP

CONTACT MATERIAL —————

B = Brass

CONTACT FINISH - RoHS Compliant —————

P = Gold Flash Overall

CONTACT CENTERS —————

B = .050" [1.27 mm]

COLOR

BK = Black

TERMINATION TYPE

ST = Straight
RA = Right Angle
SM = Surface Mount
SP = Surface Mount with Guide Posts

NUMBER OF CONTACT POSITIONS (Pins per Row)

03 thru 50

NUMBER OF ROWS

D = Dual Row

DIMENSIONS For complete drawings, go to www.sullinscorp.com or e-mail techsupport@sullinscorp.com

Dimensions in [] are in millimeters, all others are in inches.

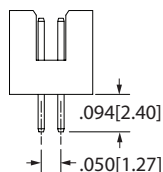

STRAIGHT (ST)

Example P/N: SBH31-NBPB-D20-ST-BK

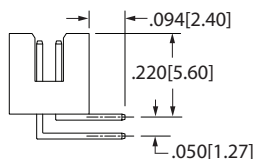

RIGHT ANGLE (RA)

Example P/N: SBH31-NBPB-D20-RA-BK

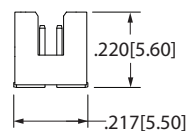

SURFACE MOUNT (SM)

Example P/N: SBH31-NBPB-D20-SM-BK

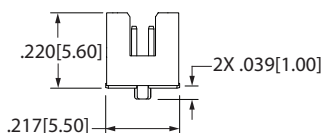

SURFACE MOUNT with Posts (SP)

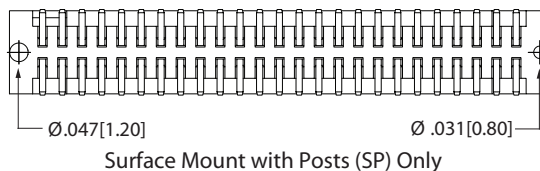
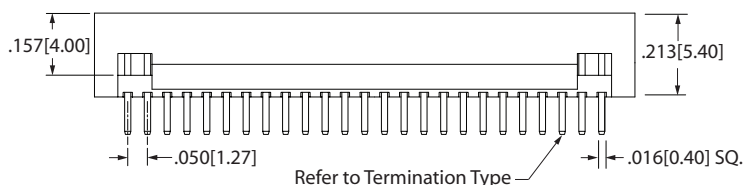
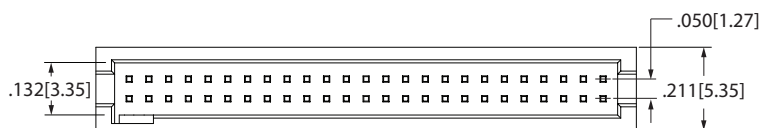

Example P/N: SBH31-NBPB-D20-SP-BK



Surface Mount with Posts (SP) Only

Looking for pricing, stock, or lifecycle information?

Click below to explore more details on WIN SOURCE:

-  [View SBH31-NBPB-D05-ST-BK on WIN SOURCE](#)
-  [Sullins Connector Solutions Information](#)

Optimize Your Supply Chain with WIN SOURCE Solutions

-  Global Sourcing Solution
-  Obsolete Management
-  Cost Control Management
-  Shortage Management
-  Alternative Solution
-  Excess Inventory Management