



**THE DATASHEET OF
SWR204-NRTN-D03-ST-GA**





SWR204 Series Dual Row Wafer 2.0 mm [.079"] Contact Centers, Straight/Right Angle

SPECIFICATIONS

- Insulator Material: Nylon, UL 94V-0 Color: Natural
- Contact Material: Brass
- Contact Resistance: 10 milli Ohms Max
- Contact Plating: .000020" Min. Nickel Underplate, Pure Tin, Bright Overall
- Current Rating: 3 Amps
- Dielectric Withstanding Voltage: 800 VAC
- Insulator Resistance: 1000 Megohms Minimum
- Operating Temperature: -25°C to +85°C
- Voltage Rating: 50 VAC/DC
- Mates with SWH204 Series Dual Row Housing

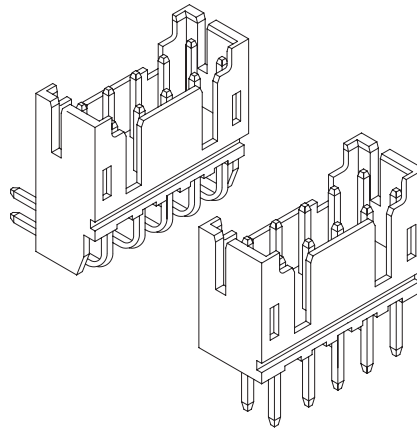

DIMENSIONS Dimensions in [] are in inches, all others are in millimeters.

SWR204-NRTN-D__-ST-GA

SWR204-NRTN-D__-RA-GA

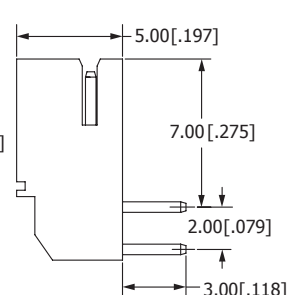
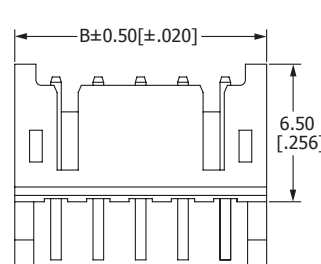
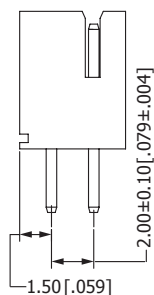
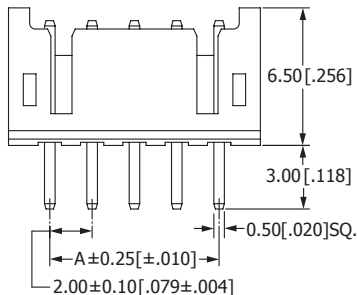
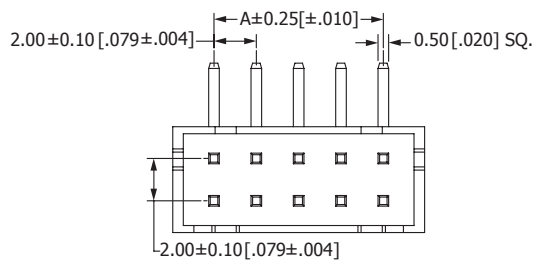
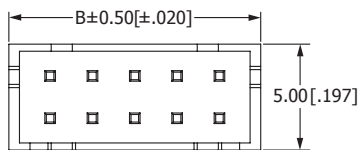



PART NUMBER OPTIONS

SWR204-NRTN-D16-ST-GA

NUMBER OF POSITIONS

02 thru 17 & 20
See Chart Below

TERMINATION TYPE

ST = Straight
RA = Right Angle

PCB LAYOUT

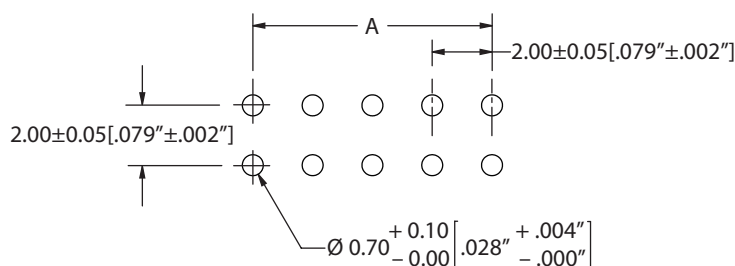



P.C. BOARD THICKNESS: 1.60 [.063"]

PART NUMBER	POSITIONS/ CONTACTS	A		B	
		mm	in	mm	in
SWR204-NRTN-D02-__-GA	02/04	2.00	0.079	5.90	0.232
SWR204-NRTN-D03-__-GA	03/06	4.00	0.157	7.90	0.311
SWR204-NRTN-D04-__-GA	04/08	6.00	0.236	9.90	0.390
SWR204-NRTN-D05-__-GA	05/10	8.00	0.315	11.90	0.469
SWR204-NRTN-D06-__-GA	06/12	10.00	0.394	13.90	0.547
SWR204-NRTN-D07-__-GA	07/14	12.00	0.472	15.90	0.626
SWR204-NRTN-D08-__-GA	08/16	14.00	0.551	17.90	0.705
SWR204-NRTN-D09-__-GA	09/18	16.00	0.630	19.90	0.783
SWR204-NRTN-D10-__-GA	10/20	18.00	0.709	21.90	0.862
SWR204-NRTN-D11-__-GA	11/22	20.00	0.787	23.90	0.941
SWR204-NRTN-D12-__-GA	12/24	22.00	0.866	25.90	1.020
SWR204-NRTN-D13-__-GA	13/26	24.00	0.945	27.90	1.098
SWR204-NRTN-D14-__-GA	14/28	26.00	1.024	29.90	1.177
SWR204-NRTN-D15-__-GA	15/30	28.00	1.102	31.90	1.256
SWR204-NRTN-D16-__-GA	16/32	30.00	1.181	33.90	1.335
SWR204-NRTN-D17-__-GA	17/34	32.00	1.260	35.90	1.413
SWR204-NRTN-D20-__-GA	20/40	38.00	1.496	41.90	1.650

Looking for pricing, stock, or lifecycle information?

Click below to explore more details on WIN SOURCE:

-  [View SWR204-NRTN-D03-ST-GA on WIN SOURCE](#)
-  [Sullins Connector Solutions Information](#)

Optimize Your Supply Chain with WIN SOURCE Solutions

-  Global Sourcing Solution
-  Obsolete Management
-  Cost Control Management
-  Shortage Management
-  Alternative Solution
-  Excess Inventory Management