



**THE DATASHEET OF  
DS25BR110TSD/NOPB**



## DS25BR110 3.125 Gbps LVDS Buffer with Receive Equalization

Check for Samples: [DS25BR110](#)

### FEATURES

- DC - 3.125 Gbps Low Jitter, High Noise Immunity, Low Power Operation
- Four Levels of Receive Equalization Reduce ISI Jitter
- On-Chip 100Ω Input and Output Termination Minimizes Insertion and Return Losses, Reduces Component Count, and Minimizes Board Space
- 7 kV ESD on LVDS I/O Pins Protects Adjoining Components
- Small 3 mm x 3 mm 8-WSON Space Saving Package

### APPLICATIONS

- Clock and Data Buffering
- Metallic Cable Equalization
- FR-4 Equalization

### DESCRIPTION

The DS25BR110 is a single channel 3.125 Gbps LVDS buffer optimized for high-speed signal transmission over lossy FR-4 printed circuit board backplanes and balanced metallic cables. A fully differential signal path ensures exceptional signal integrity and noise immunity.

The DS25BR110 features four levels of receive equalization (EQ), making it ideal for use as a receiver device. Other LVDS devices with similar IO characteristics include the following products. The DS25BR120 features four levels of pre-emphasis for use as an optimized driver device, while the DS25BR100 features both pre-emphasis and equalization for use as an optimized repeater device. The DS25BR150 is a buffer/repeater with the lowest power consumption and does not feature transmit pre-emphasis nor receive equalization.

Wide input common mode range allows the receiver to accept signals with LVDS, CML and LVPECL levels; the output levels are LVDS. A very small package footprint requires minimal space on the board while the flow-through pinout allows easy board layout. The differential inputs and outputs are internally terminated with a 100Ω resistor to lower device input and output return losses, reduce component count, and further minimize board space.

### Typical Application

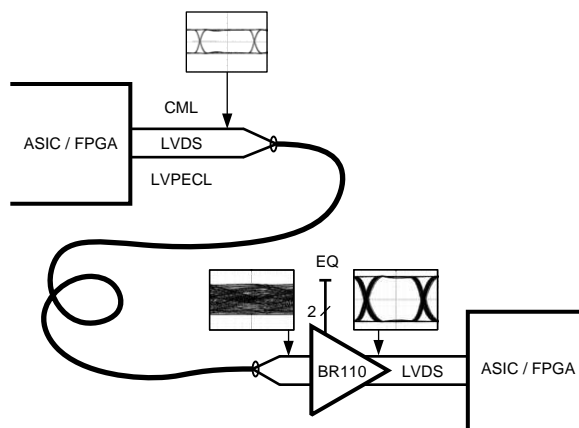

Please be aware that an important notice concerning availability, standard warranty, and use in critical applications of Texas Instruments semiconductor products and disclaimers thereto appears at the end of this data sheet.

All trademarks are the property of their respective owners.

**Block Diagram**

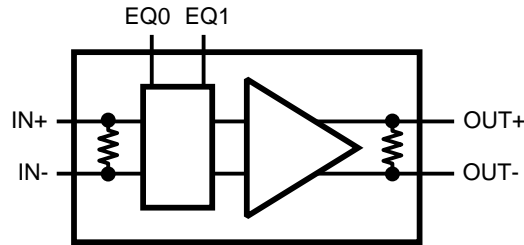

**Pin Diagram**

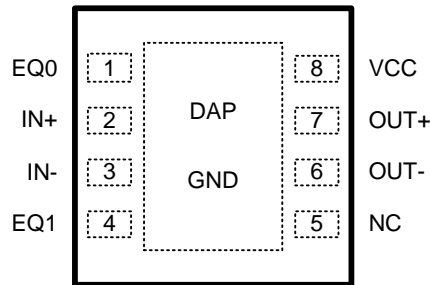

**Pin Descriptions**

Pin		Type	Description
Name	Number		
EQ0	1	Input	Equalizer select pin.
IN+	2	Input	Non-inverting LVDS input pin.
IN-	3	Input	Inverting LVDS input pin.
EQ1	4	Input	Equalizer select pin.
NC	5	NA	"NO CONNECT" pin.
OUT-	6	Output	Inverting LVDS output pin.
OUT+	7	Output	Non-inverting LVDS Output pin.
VCC	8	Power	Power supply pin.
GND	DAP	Power	Ground pad (DAP - die attach pad)

**Control Pins (EQ0 and EQ1) Truth Tables**

EQ1	EQ0	Equalization Level
0	0	Off
0	1	Low (Approx. 4 dB at 1.56 GHz)
1	0	Medium (Approx. 8 dB at 1.56 GHz)
1	1	High (Approx. 16 dB at 1.56 GHz)



These devices have limited built-in ESD protection. The leads should be shorted together or the device placed in conductive foam during storage or handling to prevent electrostatic damage to the MOS gates.

**Absolute Maximum Ratings<sup>(1)(2)</sup>**

Supply Voltage ( $V_{CC}$ )		-0.3V to +4V
LVCMOS Input Voltage (EQ0, EQ1)		-0.3V to ( $V_{CC} + 0.3V$ )
LVDS Input Voltage (IN+, IN-)		-0.3V to +4V
Differential Input Voltage  VID		1.0V
LVDS Output Voltage (OUT+, OUT-)		-0.3V to ( $V_{CC} + 0.3V$ )
LVDS Differential Output Voltage ((OUT+) - (OUT-))		0V to 1.0V
LVDS Output Short Circuit Current Duration		5 ms
Junction Temperature		+150°C
Storage Temperature Range		-65°C to +150°C
Lead Temperature Range	Soldering (4 sec.)	+260°C
Maximum Package Power Dissipation at 25°C	NGQ0008A Package	2.08W
	Derate NGQ0008A Package	16.7 mW/°C above +25°C
Package Thermal Resistance	$\theta_{JA}$	+60.0°C/W
	$\theta_{JC}$	+12.3°C/W
ESD Susceptibility	HBM <sup>(3)</sup>	≥7 kV
	MM <sup>(4)</sup>	≥250V
	CDM <sup>(5)</sup>	≥1250V

- (1) "Absolute Maximum Ratings" indicate limits beyond which damage to the device may occur, including inoperability and degradation of device reliability and/or performance. Functional operation of the device and/or non-degradation at the Absolute Maximum Ratings or other conditions beyond those indicated in the Recommended Operating Conditions is not implied. The Recommended Operating Conditions indicate conditions at which the device is functional and the device should not be operated beyond such conditions.
- (2) If Military/Aerospace specified devices are required, please contact the TI Sales Office/Distributors for availability and specifications.
- (3) Human Body Model, applicable std. JESD22-A114C
- (4) Machine Model, applicable std. JESD22-A115-A
- (5) Field Induced Charge Device Model, applicable std. JESD22-C101-C

**Recommended Operating Conditions**

	Min	Typ	Max	Units
Supply Voltage ( $V_{CC}$ )	3.0	3.3	3.6	V
Receiver Differential Input Voltage ( $V_{ID}$ )			1.0	V
Operating Free Air Temperature ( $T_A$ )	-40	+25	+85	°C

## DC Electrical Characteristics

Over recommended operating supply and temperature ranges unless otherwise specified. <sup>(1)</sup><sup>(2)</sup><sup>(3)</sup>

Parameter		Test Conditions	Min	Typ	Max	Units
<b>LVC MOS INPUT DC SPECIFICATIONS (EQ0, EQ1)</b>						
V <sub>IH</sub>	High Level Input Voltage		2.0		V <sub>CC</sub>	V
V <sub>IL</sub>	Low Level Input Voltage		GND		0.8	V
I <sub>IH</sub>	High Level Input Current	V <sub>IN</sub> = 3.6V V <sub>CC</sub> = 3.6V		0	±10	µA
I <sub>IL</sub>	Low Level Input Current	V <sub>IN</sub> = GND V <sub>CC</sub> = 3.6V		0	±10	µA
V <sub>CL</sub>	Input Clamp Voltage	I <sub>CL</sub> = -18 mA, V <sub>CC</sub> = 0V		-0.9	-1.5	V
<b>LVDS OUTPUT DC SPECIFICATIONS (OUT+, OUT-)</b>						
V <sub>OD</sub>	Differential Output Voltage		250	350	450	mV
ΔV <sub>OD</sub>	Change in Magnitude of V <sub>OD</sub> for Complimentary Output States	R <sub>L</sub> = 100Ω	-35		35	mV
V <sub>OS</sub>	Offset Voltage		1.05	1.2	1.375	V
ΔV <sub>OS</sub>	Change in Magnitude of V <sub>OS</sub> for Complimentary Output States	R <sub>L</sub> = 100Ω	-35		35	mV
I <sub>OS</sub>	Output Short Circuit Current <sup>(4)</sup>	OUT to GND		-35	-55	mA
		OUT to V <sub>CC</sub>		7	55	mA
C <sub>OUT</sub>	Output Capacitance	Any LVDS Output Pin to GND		1.2		pF
R <sub>OUT</sub>	Output Termination Resistor	Between OUT+ and OUT-		100		Ω
<b>LVDS INPUT DC SPECIFICATIONS (IN+, IN-)</b>						
V <sub>ID</sub>	Input Differential Voltage		0		1	V
V <sub>TH</sub>	Differential Input High Threshold	V <sub>CM</sub> = +0.05V or V <sub>CC</sub> -0.05V		0	+100	mV
V <sub>TL</sub>	Differential Input Low Threshold		-100	0		mV
V <sub>CMR</sub>	Common Mode Voltage Range	V <sub>ID</sub> = 100 mV	0.05		V <sub>CC</sub> - 0.05	V
I <sub>IN</sub>	Input Current	V <sub>IN</sub> = 3.6V or 0V V <sub>CC</sub> = 3.6V or 0V		±1	±10	µA
C <sub>IN</sub>	Input Capacitance	Any LVDS Input Pin to GND		1.7		pF
R <sub>IN</sub>	Input Termination Resistor	Between IN+ and IN-		100		Ω
<b>SUPPLY CURRENT</b>						
I <sub>CC</sub>	Supply Current	EQ0 = 0, EQ1 = 0		35	43	mA

- (1) The Electrical Characteristics tables list ensured specifications under the listed Recommended Operating Conditions except as otherwise modified or specified by the Electrical Characteristics Conditions and/or notes. Typical specifications are estimations only and are not ensured
- (2) Current into device pins is defined as positive. Current out of device pins is defined as negative. All voltages are referenced to ground except V<sub>OD</sub> and ΔV<sub>OD</sub>.
- (3) Typical values represent most likely parametric norms for V<sub>CC</sub> = +3.3V and T<sub>A</sub> = +25°C, and at the Recommended Operation Conditions at the time of product characterization and are not ensured
- (4) Output short circuit current (I<sub>OS</sub>) is specified as magnitude only, minus sign indicates direction only.

## AC Electrical Characteristics<sup>(1)</sup>

Over recommended operating supply and temperature ranges unless otherwise specified.<sup>(2)(3)</sup>

Parameter		Test Conditions	Min	Typ	Max	Units	
<b>LVDS OUTPUT AC SPECIFICATIONS (OUT+, OUT-)</b>							
$t_{PHLD}$	Differential Propagation Delay High to Low	$R_L = 100\Omega$		350	465	ps	
$t_{PLHD}$	Differential Propagation Delay Low to High			350	465	ps	
$t_{SKD1}$	Pulse Skew $ t_{PLHD} - t_{PHLD} ^{(4)}$			45	100	ps	
$t_{SKD2}$	Part to Part Skew <sup>(5)</sup>			45	150	ps	
$t_{LHT}$	Rise Time	$R_L = 100\Omega$		80	150	ps	
$t_{HLT}$	Fall Time			80	150	ps	
<b>JITTER PERFORMANCE WITH EQ = OFF</b>							
$t_{RJ1A}$	Random Jitter (RMS Value) No Test Channels <sup>(6)</sup>	$V_{ID} = 350\text{ mV}$ $V_{CM} = 1.2\text{V}$ Clock (RZ) $EQ0 = 0, EQ1 = 0$	2.5 Gbps		0.5	1	ps
$t_{RJ2A}$			3.125 Gbps		0.5	1	ps
$t_{DJ1A}$	Deterministic Jitter (Peak to Peak) No Test Channels <sup>(7)</sup>	$V_{ID} = 350\text{ mV}$ $V_{CM} = 1.2\text{V}$ K28.5 (NRZ) $EQ0 = 0, EQ1 = 0$	2.5 Gbps		11	40	ps
$t_{DJ2A}$			3.125 Gbps		11	47	ps
$t_{TJ1A}$	Total Jitter (Peak to Peak) No Test Channels <sup>(8)</sup>	$V_{ID} = 350\text{ mV}$ $V_{CM} = 1.2\text{V}$ PRBS-23 (NRZ) $EQ0 = 0, EQ1 = 0$	2.5 Gbps		0.05	0.16	UI <sub>P-P</sub>
$t_{TJ2A}$			3.125 Gbps		0.08	0.20	UI <sub>P-P</sub>
<b>JITTER PERFORMANCE WITH EQ = LOW (Figure 5 and Figure 6)</b>							
$t_{RJ1B}$	Random Jitter (RMS Value) Test Channel D <sup>(6)</sup>	$V_{ID} = 350\text{ mV}$ $V_{CM} = 1.2\text{V}$ Clock (RZ) $EQ0 = 1, EQ1 = 0$	2.5 Gbps		0.5	1	ps
$t_{RJ2B}$			3.125 Gbps		0.5	1	ps
$t_{DJ1B}$	Deterministic Jitter (Peak to Peak) Test Channel D <sup>(7)</sup>	$V_{ID} = 350\text{ mV}$ $V_{CM} = 1.2\text{V}$ K28.5 (NRZ) $EQ0 = 1, EQ1 = 0$	2.5 Gbps		1	16	ps
$t_{DJ2B}$			3.125 Gbps		11	31	ps
$t_{TJ1B}$	Total Jitter (Peak to Peak) Test Channel D <sup>(8)</sup>	$V_{ID} = 350\text{ mV}$ $V_{CM} = 1.2\text{V}$ PRBS-23 (NRZ) $EQ0 = 1, EQ1 = 0$	2.5 Gbps		0.03	0.09	UI <sub>P-P</sub>
$t_{TJ2B}$			3.125 Gbps		0.06	0.14	UI <sub>P-P</sub>
<b>JITTER PERFORMANCE WITH EQ = MEDIUM (Figure 5 and Figure 6)</b>							
$t_{RJ1C}$	Random Jitter (RMS Value) Test Channel E <sup>(6)</sup>	$V_{ID} = 350\text{ mV}$ $V_{CM} = 1.2\text{V}$ Clock (RZ) $EQ0 = 0, EQ1 = 1$	2.5 Gbps		0.5	1	ps
$t_{RJ2C}$			3.125 Gbps		0.5	1	ps
$t_{DJ1C}$	Deterministic Jitter (Peak to Peak) Test Channel E <sup>(7)</sup>	$V_{ID} = 350\text{ mV}$ $V_{CM} = 1.2\text{V}$ K28.5 (NRZ) $EQ0 = 0, EQ1 = 1$	2.5 Gbps		10	29	ps
$t_{DJ2C}$			3.125 Gbps		27	43	ps

(1) Specification is ensured by characterization and is not tested in production.

(2) The Electrical Characteristics tables list ensured specifications under the listed Recommended Operating Conditions except as otherwise modified or specified by the Electrical Characteristics Conditions and/or notes. Typical specifications are estimations only and are not ensured.

(3) Typical values represent most likely parametric norms for  $V_{CC} = +3.3\text{V}$  and  $T_A = +25^\circ\text{C}$ , and at the Recommended Operation Conditions at the time of product characterization and are not ensured.

(4)  $t_{SKD1}$ ,  $|t_{PLHD} - t_{PHLD}|$ , is the magnitude difference in differential propagation delay time between the positive going edge and the negative going edge of the same channel.

(5)  $t_{SKD2}$ , Part to Part Skew, is defined as the difference between the minimum and maximum specified differential propagation delays. This specification applies to devices at the same  $V_{CC}$  and within  $5^\circ\text{C}$  of each other within the operating temperature range.

(6) Measured on a clock edge with a histogram and an accumulation of 1500 histogram hits. Input stimulus jitter is subtracted geometrically.

(7) Tested with a combination of the 110000101 (K28.5+ character) and 0011111010 (K28.5- character) patterns. Input stimulus jitter is subtracted algebraically.

(8) Measured on an eye diagram with a histogram and an accumulation of 3500 histogram hits. Input stimulus jitter is subtracted.

## AC Electrical Characteristics<sup>(1)</sup> (continued)

Over recommended operating supply and temperature ranges unless otherwise specified.<sup>(2)(3)</sup>

Parameter		Test Conditions	Min	Typ	Max	Units	
t <sub>TJ1C</sub>	Total Jitter (Peak to Peak) Test Channel E <sup>(8)</sup>	V <sub>ID</sub> = 350 mV V <sub>CM</sub> = 1.2V PRBS-23 (NRZ) EQ0 = 0, EQ1 = 1	2.5 Gbps		0.07	0.12	UI <sub>P-P</sub>
t <sub>TJ2C</sub>			3.125 Gbps		0.12	0.17	UI <sub>P-P</sub>
<b>JITTER PERFORMANCE WITH EQ = HIGH (Figure 5 and Figure 6)</b>							
t <sub>RJ1D</sub>	Random Jitter (RMS Value) Test Channel F <sup>(6)</sup>	V <sub>ID</sub> = 350 mV V <sub>CM</sub> = 1.2V Clock (RZ) EQ0 = 1, EQ1 = 1	2.5 Gbps		1.6	2.1	ps
t <sub>RJ2D</sub>				3.125 Gbps		1.7	2.3
t <sub>DJ1D</sub>	Deterministic Jitter (Peak to Peak) Test Channel F <sup>(7)</sup>	V <sub>ID</sub> = 350 mV V <sub>CM</sub> = 1.2V K28.5 (NRZ) EQ0 = 1, EQ1 = 1	2.5 Gbps		30	45	ps
t <sub>DJ2D</sub>				3.125 Gbps		43	59
t <sub>TJ1D</sub>	Total Jitter (Peak to Peak) Test Channel F <sup>(8)</sup>	V <sub>ID</sub> = 350 mV V <sub>CM</sub> = 1.2V PRBS-23 (NRZ) EQ0 = 1, EQ1 = 1	2.5 Gbps		0.14	0.27	UI <sub>P-P</sub>
t <sub>TJ2D</sub>				3.125 Gbps		0.19	0.28

### DC TEST CIRCUITS

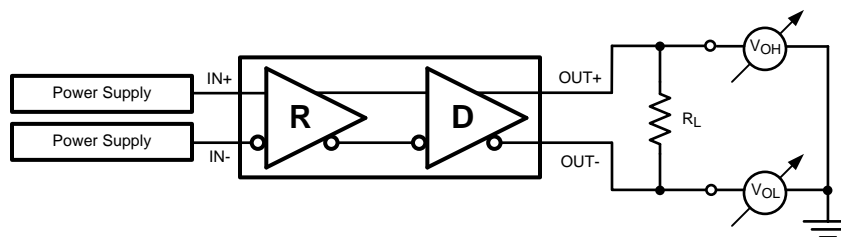

Figure 1. Differential Driver DC Test Circuit

### AC Test Circuits and Timing Diagrams

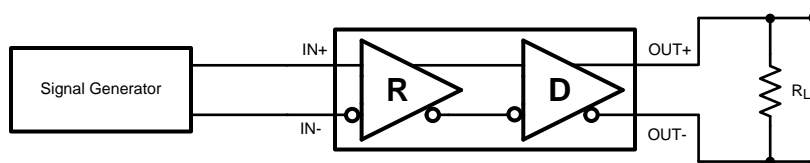

Figure 2. Differential Driver AC Test Circuit

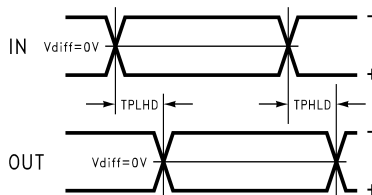

Figure 3. Propagation Delay Timing Diagram

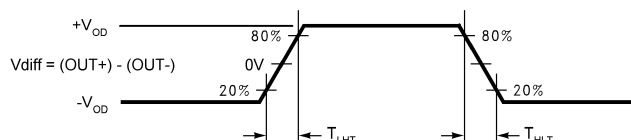

Figure 4. LVDS Output Transition Times

### Equalization Test Circuits

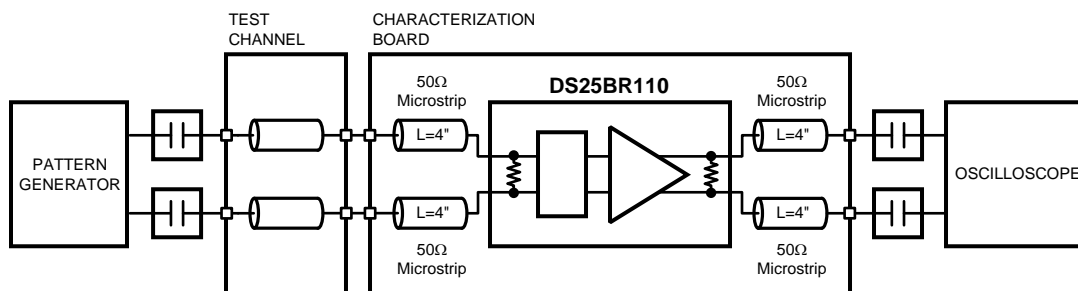

Figure 5. Equalization Performance Test Circuit

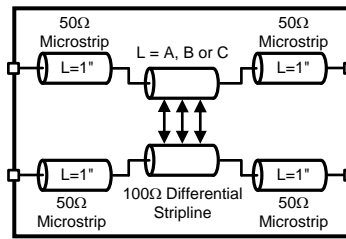

Figure 6. Test Channel Description

**Test Channel Loss Characteristics**

The test channel was fabricated with Polyclad PCL-FR-370-Laminate/PCL-FRP-370 Prepreg materials (Dielectric constant of 3.7 and Loss Tangent of 0.02). The edge coupled differential striplines have the following geometries: Trace Width (W) = 5 mils, Gap (S) = 5 mils, Height (B) = 16 mils.

Test Channel	Length (inches)	Insertion Loss (dB)					
		500 MHz	750 MHz	1000 MHz	1250 MHz	1500 MHz	1560 MHz
A	10	-1.2	-1.7	-2.0	-2.4	-2.7	-2.8
B	20	-2.6	-3.5	-4.1	-4.8	-5.5	-5.6
C	30	-4.3	-5.7	-7.0	-8.2	-9.4	-9.7
D	15	-1.6	-2.2	-2.7	-3.2	-3.7	-3.8
E	30	-3.4	-4.5	-5.6	-6.6	-7.7	-7.9
F	60	-7.8	-10.3	-12.4	-14.5	-16.6	-17.0

**Device Operation**

**INPUT INTERFACING**

The DS25BR110 accepts differential signals and allows simple AC or DC coupling. With a wide common mode range, the DS25BR110 can be DC-coupled with all common differential drivers (i.e., LVPECL, LVDS, CML). The following three figures illustrate typical DC-coupled interface to common differential drivers. Note that the DS25BR110 inputs are internally terminated with a 100Ω resistor.

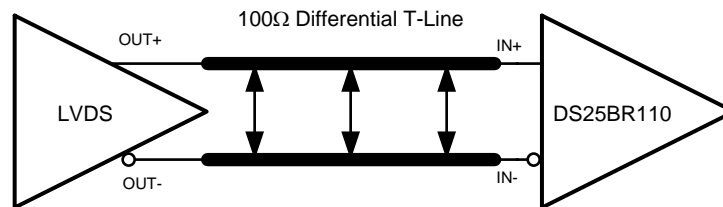

Figure 7. Typical LVDS Driver DC-Coupled Interface to DS25BR110 Input

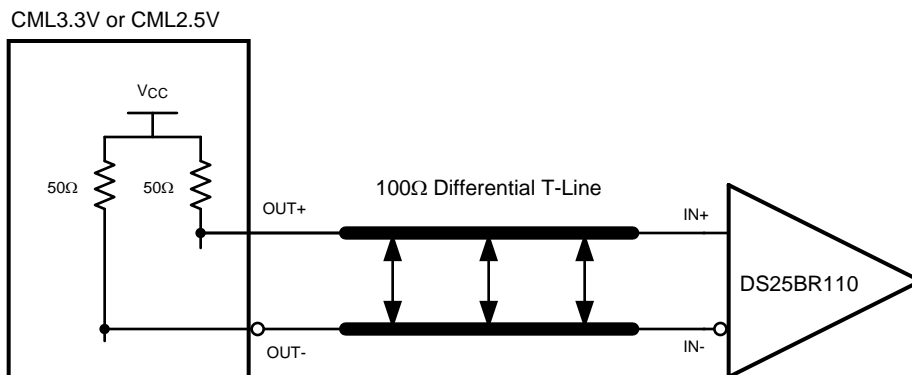

Figure 8. Typical CML Driver DC-Coupled Interface to DS25BR110 Input

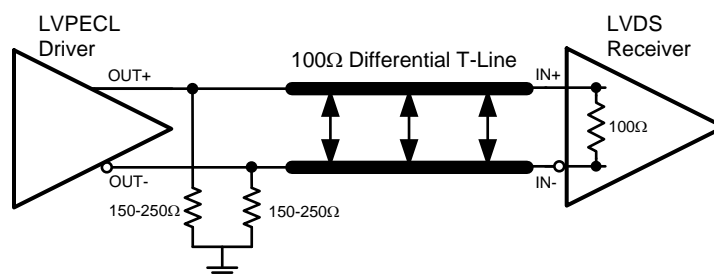

Figure 9. Typical LVPECL Driver DC-Coupled Interface to DS25BR110 Input

## OUTPUT INTERFACING

The DS25BR110 outputs signals compliant to the LVDS standard. It can be DC-coupled to most common differential receivers. The following figure illustrates typical DC-coupled interface to common differential receivers and assumes that the receivers have high impedance inputs. While most differential receivers have a common mode input range that can accommodate LVDS compliant signals, it is recommended to check the respective receiver's datasheet prior to implementing the suggested interface implementation.

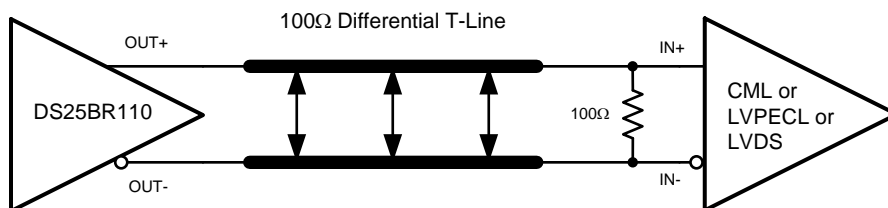

Figure 10. Typical DS25BR110 Output DC-Coupled Interface to an LVDS, CML or LVPECL Receiver

Typical Performance

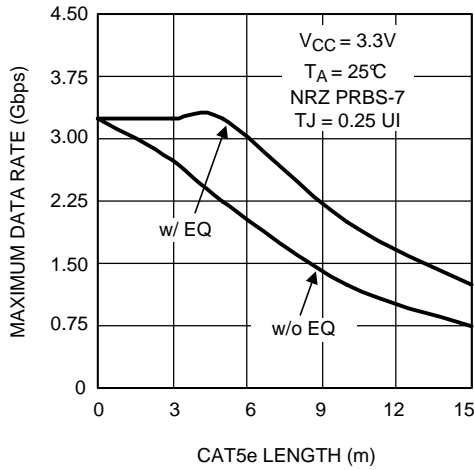

Figure 11. Maximum Data Rate as a Function of CAT5e (Belden 1700A) Length

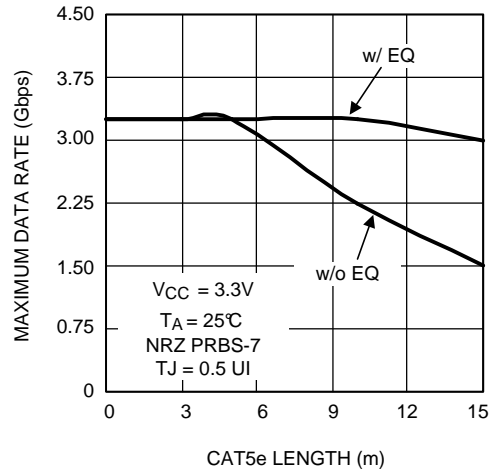

Figure 12. Maximum Data Rate as a Function of CAT5e (Belden 1700A) Length

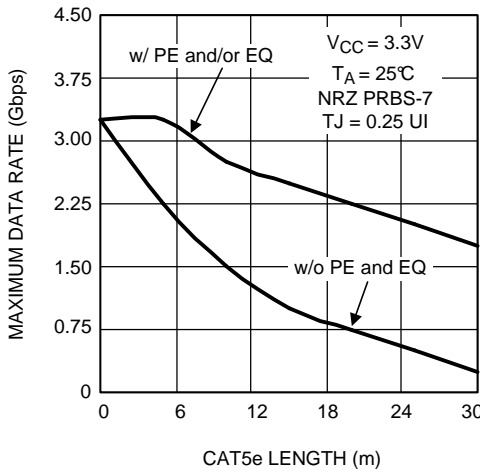

Figure 13. Maximum Data Rate as a Function of CAT5e (Belden 1700A) Length  
DS25BR120 Used as a Driver  
DS25BR110 Used as a Receiver

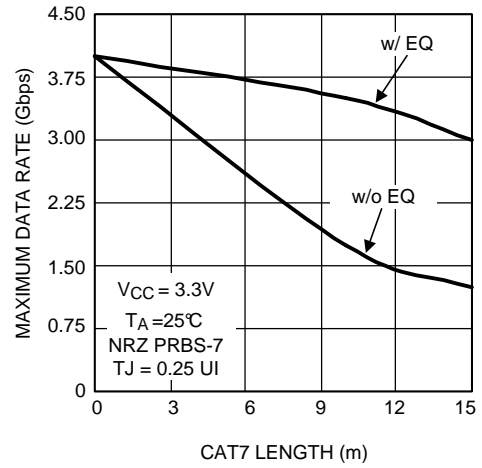

Figure 14. Maximum Data Rate as a Function of CAT7 (Siemon Tera) Length

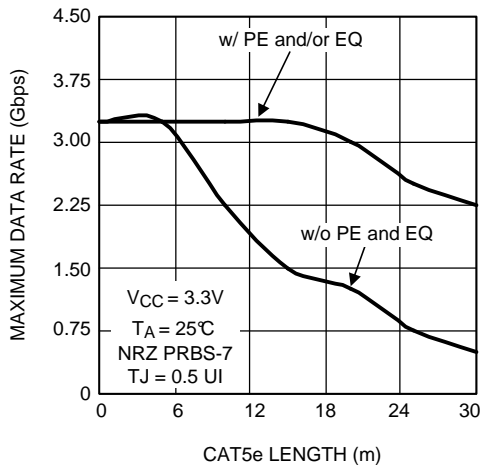

Figure 15. Maximum Data Rate as a Function of CAT5e (Belden 1700A) Length  
DS25BR120 Used as a Driver  
DS25BR110 Used as a Receiver

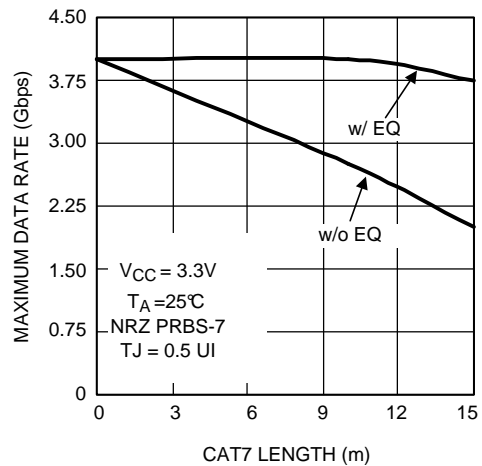

Figure 16. Maximum Data Rate as a Function of CAT7 (Slemon Tera) Length

Typical Performance (continued)

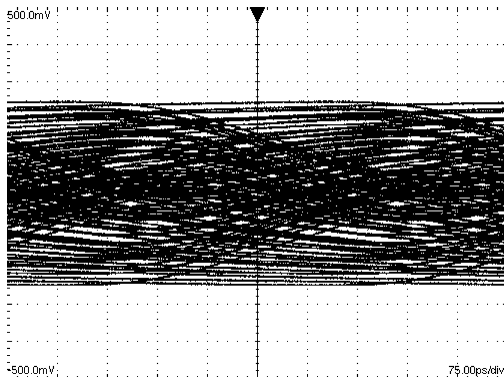

Figure 17. A 2.5 Gbps NRZ PRBS-7 After 70" Differential FR-4 Stripline  
V:100 mV / DIV, H:75 ps / DIV

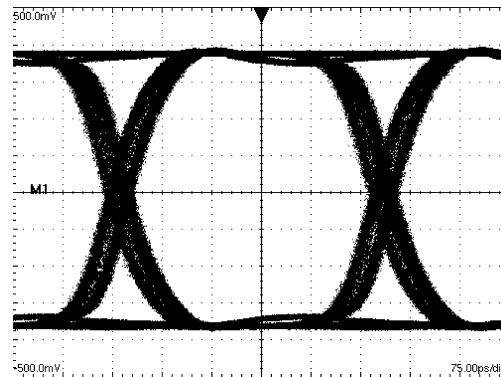

Figure 18. An Equalized 2.5 Gbps NRZ PRBS-7 After 70" Differential FR-4 Stripline  
V:100 mV / DIV, H:75 ps / DIV

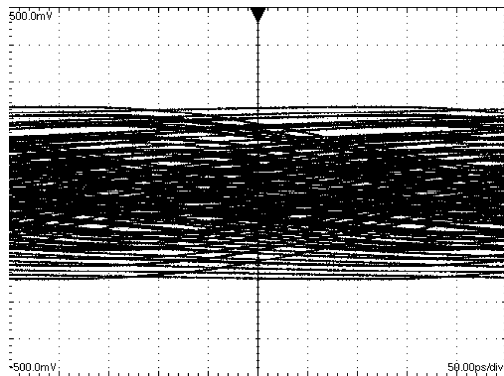

Figure 19. A 3.125 Gbps NRZ PRBS-7 After 70" Differential FR-4 Stripline  
V:100 mV / DIV, H:50 ps / DIV

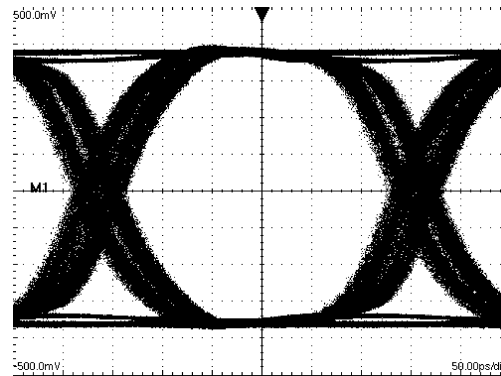

Figure 20. An Equalized 3.125 Gbps NRZ PRBS-7 After 70" Differential FR-4 Stripline  
V:100 mV / DIV, H:50 ps / DIV

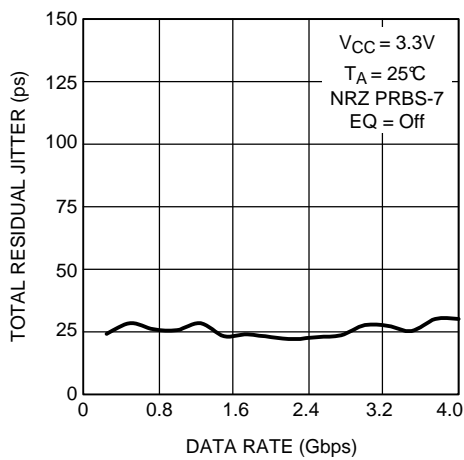

Figure 21. Total Jitter as a Function of Data Rate

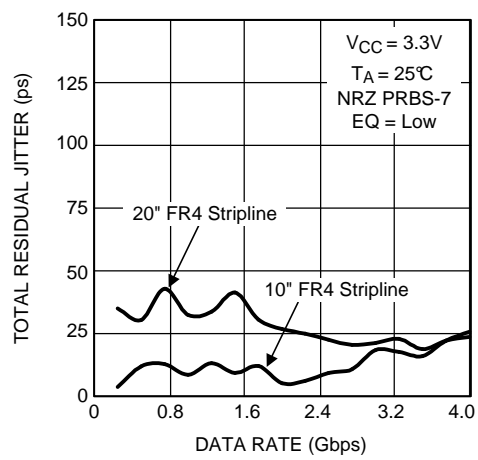

Figure 22. Total Jitter as a Function of Data Rate

Typical Performance (continued)

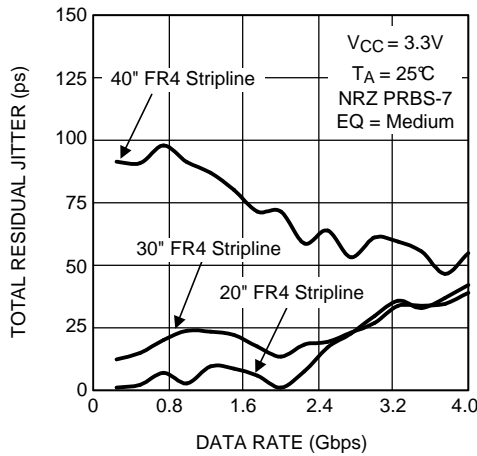

Figure 23. Total Jitter as a Function of Data Rate

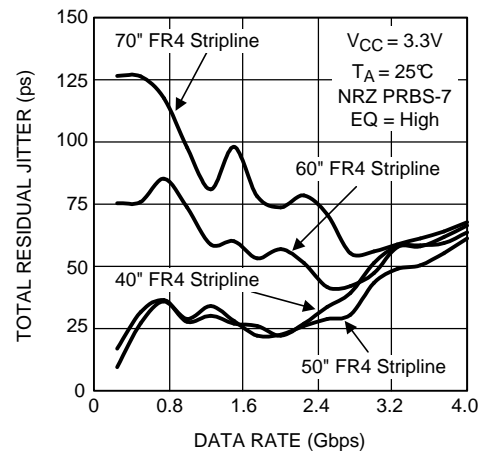

Figure 24. Total Jitter as a Function of Data Rate

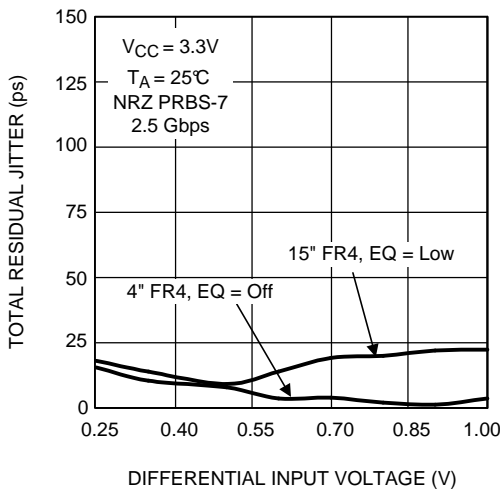

Figure 25. Total Jitter as a Function of Input Amplitude

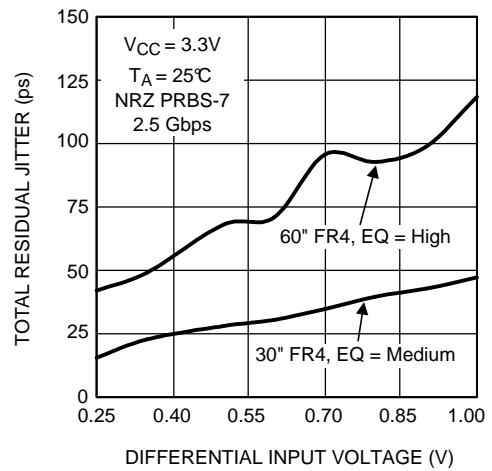

Figure 26. Total Jitter as a Function of Input Amplitude

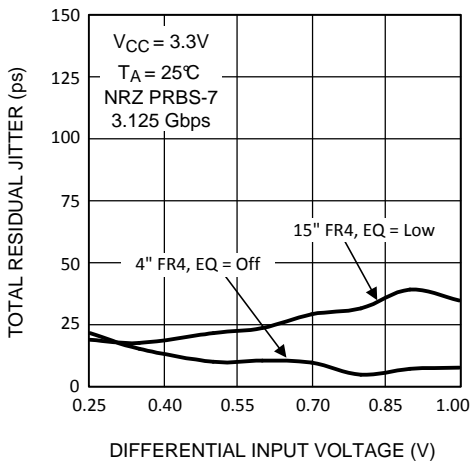

Figure 27. Total Jitter as a Function of Input Amplitude

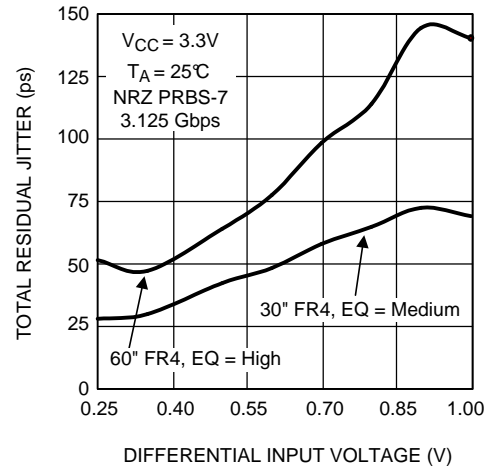

Figure 28. Total Jitter as a Function of Input Amplitude

---

**REVISION HISTORY**

<b>Changes from Revision D (April 2013) to Revision E</b>	<b>Page</b>
• Changed layout of National Data Sheet to TI format .....	<a href="#">12</a>

---

**PACKAGING INFORMATION**

Orderable Device	Status (1)	Package Type	Package Drawing	Pins	Package Qty	Eco Plan (2)	Lead/Ball Finish	MSL Peak Temp (3)	Op Temp (°C)	Top-Side Markings (4)	Samples
DS25BR110TSD/NOPB	ACTIVE	WSO	NGQ	8	1000	Green (RoHS & no Sb/Br)	CU SN	Level-3-260C-168 HR	-40 to 85	2R110	<a href="#">Samples</a>
DS25BR110TSDX/NOPB	ACTIVE	WSO	NGQ	8	4500	Green (RoHS & no Sb/Br)	CU SN	Level-3-260C-168 HR	-40 to 85	2R110	<a href="#">Samples</a>

(1) The marketing status values are defined as follows:

**ACTIVE:** Product device recommended for new designs.

**LIFEBUY:** TI has announced that the device will be discontinued, and a lifetime-buy period is in effect.

**NRND:** Not recommended for new designs. Device is in production to support existing customers, but TI does not recommend using this part in a new design.

**PREVIEW:** Device has been announced but is not in production. Samples may or may not be available.

**OBSOLETE:** TI has discontinued the production of the device.

(2) Eco Plan - The planned eco-friendly classification: Pb-Free (RoHS), Pb-Free (RoHS Exempt), or Green (RoHS & no Sb/Br) - please check <http://www.ti.com/productcontent> for the latest availability information and additional product content details.

**TBD:** The Pb-Free/Green conversion plan has not been defined.

**Pb-Free (RoHS):** TI's terms "Lead-Free" or "Pb-Free" mean semiconductor products that are compatible with the current RoHS requirements for all 6 substances, including the requirement that lead not exceed 0.1% by weight in homogeneous materials. Where designed to be soldered at high temperatures, TI Pb-Free products are suitable for use in specified lead-free processes.

**Pb-Free (RoHS Exempt):** This component has a RoHS exemption for either 1) lead-based flip-chip solder bumps used between the die and package, or 2) lead-based die adhesive used between the die and leadframe. The component is otherwise considered Pb-Free (RoHS compatible) as defined above.

**Green (RoHS & no Sb/Br):** TI defines "Green" to mean Pb-Free (RoHS compatible), and free of Bromine (Br) and Antimony (Sb) based flame retardants (Br or Sb do not exceed 0.1% by weight in homogeneous material)

(3) MSL, Peak Temp. -- The Moisture Sensitivity Level rating according to the JEDEC industry standard classifications, and peak solder temperature.

(4) Multiple Top-Side Markings will be inside parentheses. Only one Top-Side Marking contained in parentheses and separated by a "~" will appear on a device. If a line is indented then it is a continuation of the previous line and the two combined represent the entire Top-Side Marking for that device.

**Important Information and Disclaimer:** The information provided on this page represents TI's knowledge and belief as of the date that it is provided. TI bases its knowledge and belief on information provided by third parties, and makes no representation or warranty as to the accuracy of such information. Efforts are underway to better integrate information from third parties. TI has taken and continues to take reasonable steps to provide representative and accurate information but may not have conducted destructive testing or chemical analysis on incoming materials and chemicals. TI and TI suppliers consider certain information to be proprietary, and thus CAS numbers and other limited information may not be available for release.

In no event shall TI's liability arising out of such information exceed the total purchase price of the TI part(s) at issue in this document sold by TI to Customer on an annual basis.

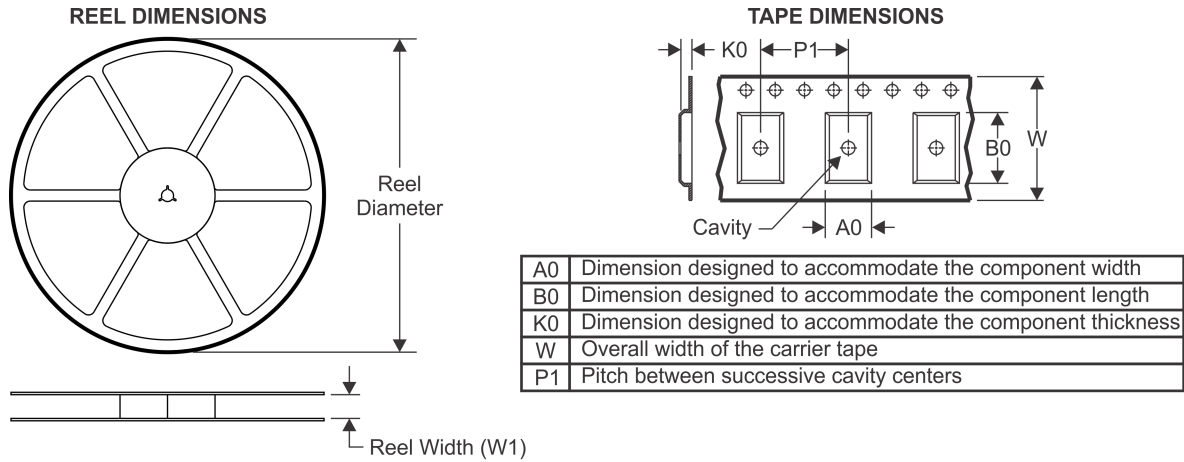
**TAPE AND REEL INFORMATION**

**QUADRANT ASSIGNMENTS FOR PIN 1 ORIENTATION IN TAPE**



\*All dimensions are nominal

Device	Package Type	Package Drawing	Pins	SPQ	Reel Diameter (mm)	Reel Width W1 (mm)	A0 (mm)	B0 (mm)	K0 (mm)	P1 (mm)	W (mm)	Pin1 Quadrant
DS25BR110TSD/NOPB	WSON	NGQ	8	1000	178.0	12.4	3.3	3.3	1.0	8.0	12.0	Q1
DS25BR110TSDX/NOPB	WSON	NGQ	8	4500	330.0	12.4	3.3	3.3	1.0	8.0	12.0	Q1

**TAPE AND REEL BOX DIMENSIONS**

\*All dimensions are nominal

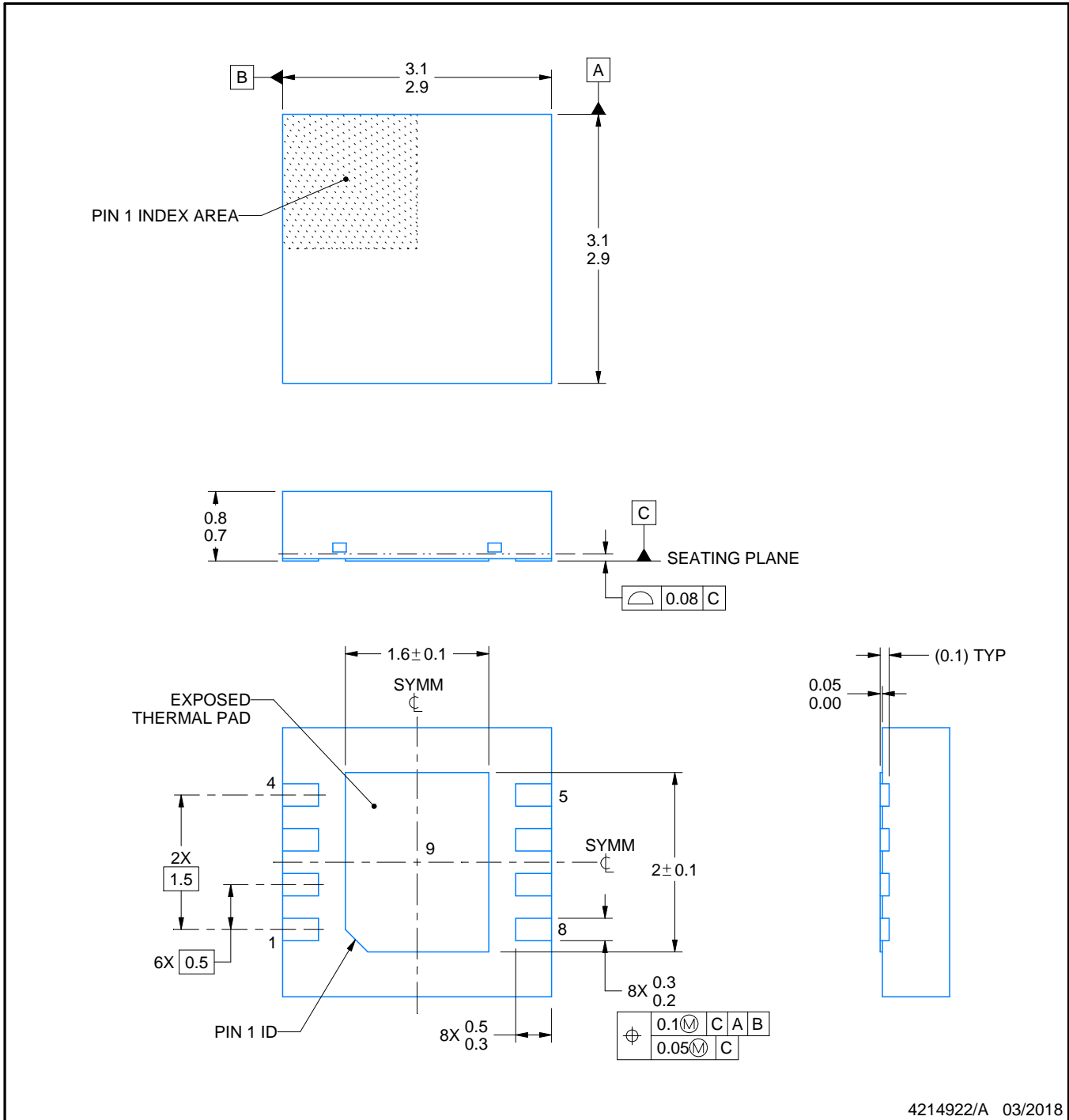
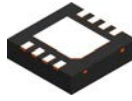
Device	Package Type	Package Drawing	Pins	SPQ	Length (mm)	Width (mm)	Height (mm)
DS25BR110TSD/NOPB	WSON	NGQ	8	1000	210.0	185.0	35.0
DS25BR110TSDX/NOPB	WSON	NGQ	8	4500	367.0	367.0	35.0



4214922/A 03/2018

NOTES:

1. All linear dimensions are in millimeters. Any dimensions in parenthesis are for reference only. Dimensioning and tolerancing per ASME Y14.5M.
2. This drawing is subject to change without notice.
3. The package thermal pad must be soldered to the printed circuit board for thermal and mechanical performance.

# EXAMPLE BOARD LAYOUT

NGQ0008A

WSON - 0.8 mm max height

PLASTIC SMALL OUTLINE - NO LEAD

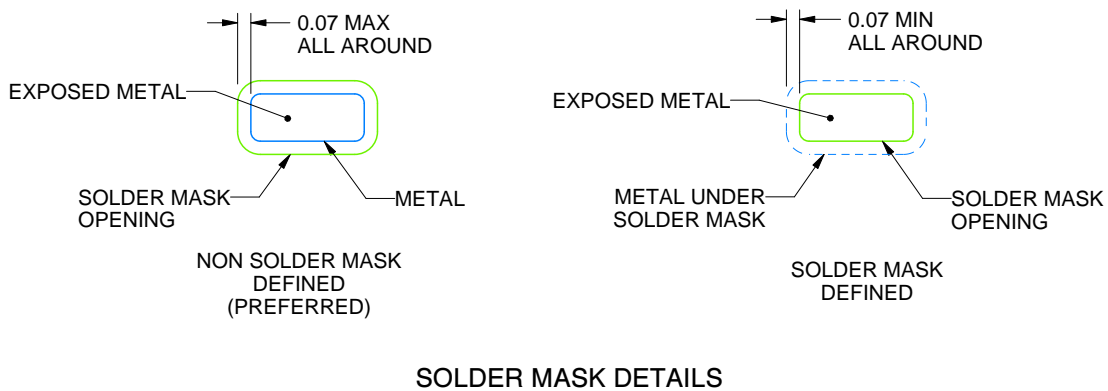
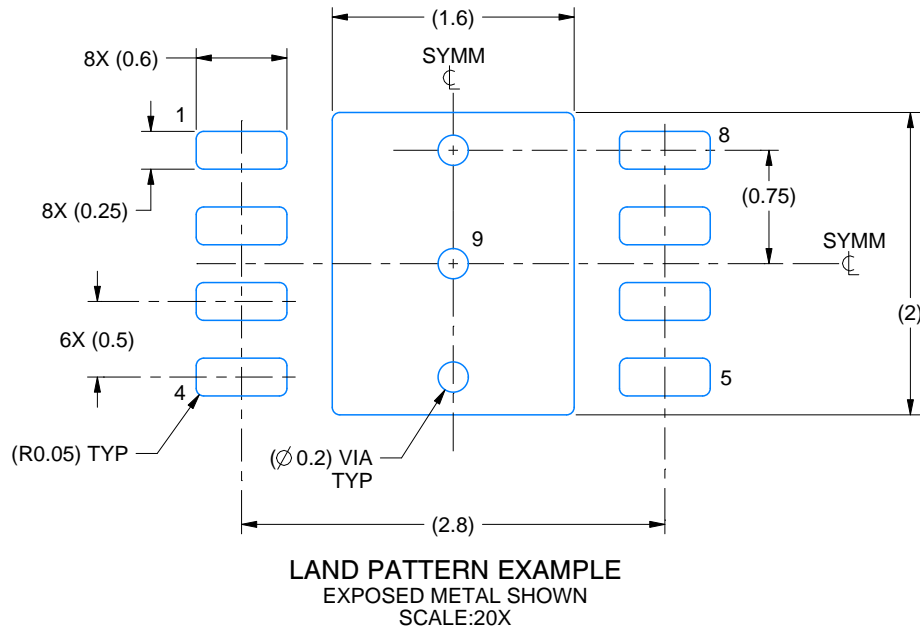

4214922/A 03/2018

NOTES: (continued)

4. This package is designed to be soldered to a thermal pad on the board. For more information, see Texas Instruments literature number SLUA271 ([www.ti.com/lit/sluea271](http://www.ti.com/lit/sluea271)).
5. Vias are optional depending on application, refer to device data sheet. If any vias are implemented, refer to their locations shown on this view. It is recommended that vias under paste be filled, plugged or tented.

# EXAMPLE STENCIL DESIGN

NGQ0008A

WSON - 0.8 mm max height

PLASTIC SMALL OUTLINE - NO LEAD

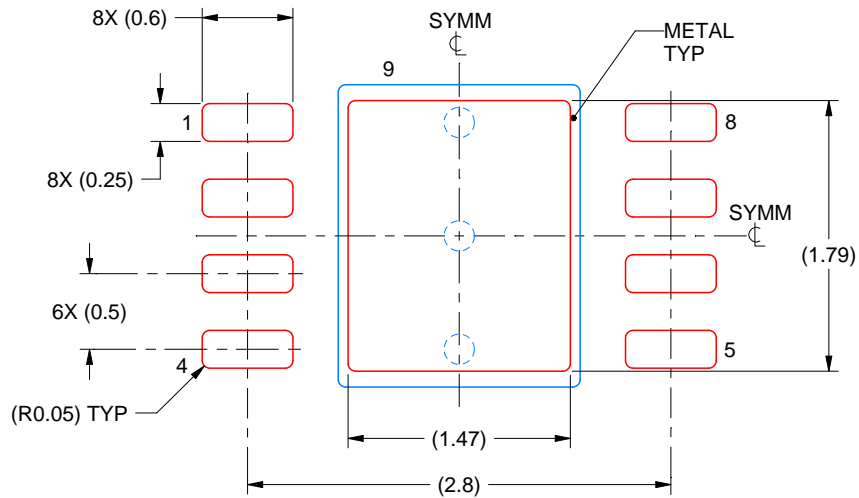

SOLDER PASTE EXAMPLE  
BASED ON 0.1 mm THICK STENCIL

EXPOSED PAD 9:  
82% PRINTED SOLDER COVERAGE BY AREA UNDER PACKAGE  
SCALE:20X

4214922/A 03/2018

NOTES: (continued)

6. Laser cutting apertures with trapezoidal walls and rounded corners may offer better paste release. IPC-7525 may have alternate design recommendations.

## IMPORTANT NOTICE

Texas Instruments Incorporated (TI) reserves the right to make corrections, enhancements, improvements and other changes to its semiconductor products and services per JESD46, latest issue, and to discontinue any product or service per JESD48, latest issue. Buyers should obtain the latest relevant information before placing orders and should verify that such information is current and complete.

TI's published terms of sale for semiconductor products (<http://www.ti.com/sc/docs/stdterms.htm>) apply to the sale of packaged integrated circuit products that TI has qualified and released to market. Additional terms may apply to the use or sale of other types of TI products and services.

Reproduction of significant portions of TI information in TI data sheets is permissible only if reproduction is without alteration and is accompanied by all associated warranties, conditions, limitations, and notices. TI is not responsible or liable for such reproduced documentation. Information of third parties may be subject to additional restrictions. Resale of TI products or services with statements different from or beyond the parameters stated by TI for that product or service voids all express and any implied warranties for the associated TI product or service and is an unfair and deceptive business practice. TI is not responsible or liable for any such statements.

Buyers and others who are developing systems that incorporate TI products (collectively, "Designers") understand and agree that Designers remain responsible for using their independent analysis, evaluation and judgment in designing their applications and that Designers have full and exclusive responsibility to assure the safety of Designers' applications and compliance of their applications (and of all TI products used in or for Designers' applications) with all applicable regulations, laws and other applicable requirements. Designer represents that, with respect to their applications, Designer has all the necessary expertise to create and implement safeguards that (1) anticipate dangerous consequences of failures, (2) monitor failures and their consequences, and (3) lessen the likelihood of failures that might cause harm and take appropriate actions. Designer agrees that prior to using or distributing any applications that include TI products, Designer will thoroughly test such applications and the functionality of such TI products as used in such applications.

TI's provision of technical, application or other design advice, quality characterization, reliability data or other services or information, including, but not limited to, reference designs and materials relating to evaluation modules, (collectively, "TI Resources") are intended to assist designers who are developing applications that incorporate TI products; by downloading, accessing or using TI Resources in any way, Designer (individually or, if Designer is acting on behalf of a company, Designer's company) agrees to use any particular TI Resource solely for this purpose and subject to the terms of this Notice.

TI's provision of TI Resources does not expand or otherwise alter TI's applicable published warranties or warranty disclaimers for TI products, and no additional obligations or liabilities arise from TI providing such TI Resources. TI reserves the right to make corrections, enhancements, improvements and other changes to its TI Resources. TI has not conducted any testing other than that specifically described in the published documentation for a particular TI Resource.

Designer is authorized to use, copy and modify any individual TI Resource only in connection with the development of applications that include the TI product(s) identified in such TI Resource. NO OTHER LICENSE, EXPRESS OR IMPLIED, BY ESTOPPEL OR OTHERWISE TO ANY OTHER TI INTELLECTUAL PROPERTY RIGHT, AND NO LICENSE TO ANY TECHNOLOGY OR INTELLECTUAL PROPERTY RIGHT OF TI OR ANY THIRD PARTY IS GRANTED HEREIN, including but not limited to any patent right, copyright, mask work right, or other intellectual property right relating to any combination, machine, or process in which TI products or services are used. Information regarding or referencing third-party products or services does not constitute a license to use such products or services, or a warranty or endorsement thereof. Use of TI Resources may require a license from a third party under the patents or other intellectual property of the third party, or a license from TI under the patents or other intellectual property of TI.

TI RESOURCES ARE PROVIDED "AS IS" AND WITH ALL FAULTS. TI DISCLAIMS ALL OTHER WARRANTIES OR REPRESENTATIONS, EXPRESS OR IMPLIED, REGARDING RESOURCES OR USE THEREOF, INCLUDING BUT NOT LIMITED TO ACCURACY OR COMPLETENESS, TITLE, ANY EPIDEMIC FAILURE WARRANTY AND ANY IMPLIED WARRANTIES OF MERCHANTABILITY, FITNESS FOR A PARTICULAR PURPOSE, AND NON-INFRINGEMENT OF ANY THIRD PARTY INTELLECTUAL PROPERTY RIGHTS. TI SHALL NOT BE LIABLE FOR AND SHALL NOT DEFEND OR INDEMNIFY DESIGNER AGAINST ANY CLAIM, INCLUDING BUT NOT LIMITED TO ANY INFRINGEMENT CLAIM THAT RELATES TO OR IS BASED ON ANY COMBINATION OF PRODUCTS EVEN IF DESCRIBED IN TI RESOURCES OR OTHERWISE. IN NO EVENT SHALL TI BE LIABLE FOR ANY ACTUAL, DIRECT, SPECIAL, COLLATERAL, INDIRECT, PUNITIVE, INCIDENTAL, CONSEQUENTIAL OR EXEMPLARY DAMAGES IN CONNECTION WITH OR ARISING OUT OF TI RESOURCES OR USE THEREOF, AND REGARDLESS OF WHETHER TI HAS BEEN ADVISED OF THE POSSIBILITY OF SUCH DAMAGES.

Unless TI has explicitly designated an individual product as meeting the requirements of a particular industry standard (e.g., ISO/TS 16949 and ISO 26262), TI is not responsible for any failure to meet such industry standard requirements.

Where TI specifically promotes products as facilitating functional safety or as compliant with industry functional safety standards, such products are intended to help enable customers to design and create their own applications that meet applicable functional safety standards and requirements. Using products in an application does not by itself establish any safety features in the application. Designers must ensure compliance with safety-related requirements and standards applicable to their applications. Designer may not use any TI products in life-critical medical equipment unless authorized officers of the parties have executed a special contract specifically governing such use. Life-critical medical equipment is medical equipment where failure of such equipment would cause serious bodily injury or death (e.g., life support, pacemakers, defibrillators, heart pumps, neurostimulators, and implantables). Such equipment includes, without limitation, all medical devices identified by the U.S. Food and Drug Administration as Class III devices and equivalent classifications outside the U.S.

TI may expressly designate certain products as completing a particular qualification (e.g., Q100, Military Grade, or Enhanced Product). Designers agree that it has the necessary expertise to select the product with the appropriate qualification designation for their applications and that proper product selection is at Designers' own risk. Designers are solely responsible for compliance with all legal and regulatory requirements in connection with such selection.

Designer will fully indemnify TI and its representatives against any damages, costs, losses, and/or liabilities arising out of Designer's non-compliance with the terms and provisions of this Notice.

## Looking for pricing, stock, or lifecycle information?

Click below to explore more details on WIN SOURCE:

 [View DS25BR110TSD/NOPB on WIN SOURCE](#)

 [Texas Instruments](#) Information

## Optimize Your Supply Chain with WIN SOURCE Solutions

-  Global Sourcing Solution
-  Obsolete Management
-  Cost Control Management
-  Shortage Management
-  Alternative Solution
-  Excess Inventory Management