



**THE DATASHEET OF
RSP-122811-01**



REVISION H

- NOTES:
 1. NOT AVAILABLE AS STANDARD.
 2. (C) REPRESENTS A CRITICAL DIMENSION.
 3. PARTS TO BE PACKAGED IN TAPE & REEL.
 4. QUANTITIES UNDER 5000 PCS WILL BE SHIPPED IN POCKETS WITH COVER TAPE BUT NOT ON A REEL.
 5. ROHS COMPLIANT.
 6. MINIMUM CONTACT RETENTION FORCE : 0.4 N

SPECIFICATIONS:
 ELECTRICAL RATINGS

IMPEDANCE	50 Ω
RATED VOLTAGE	60 V AC (RMS)
RATED FREQUENCY	DC TO 6 GHz
OPERATING TEMP RANGE	-40C to 90C
OPERATING HUMIDITY	90% OR LESS

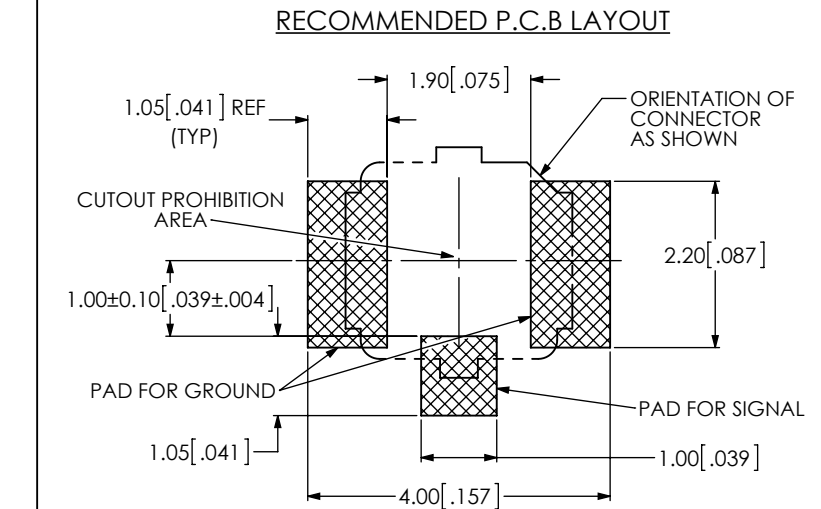
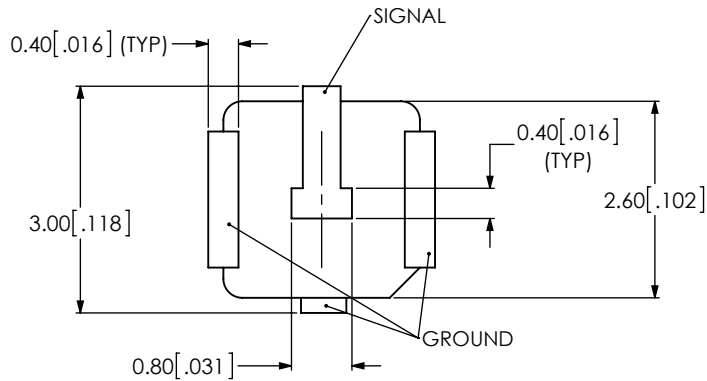
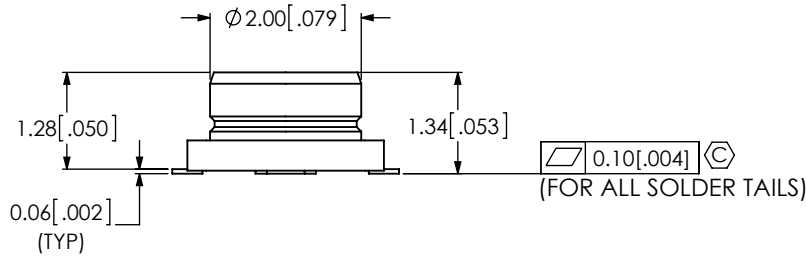
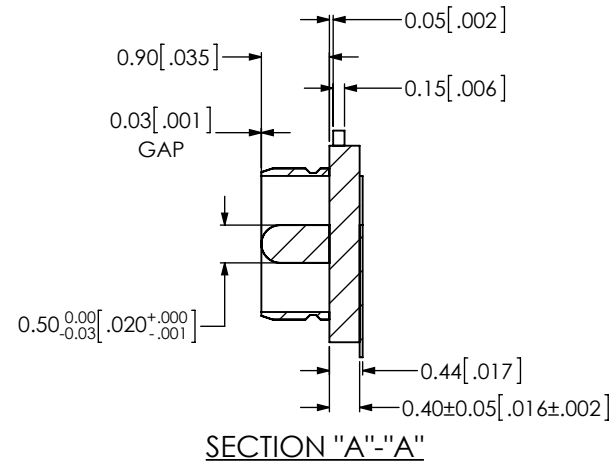
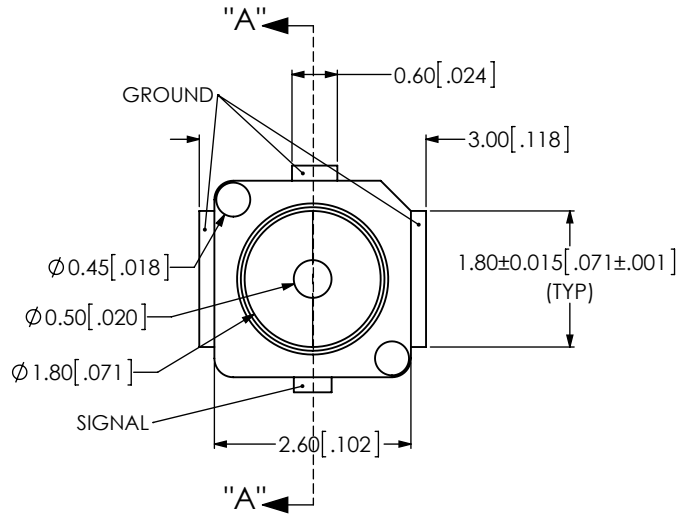

BY SIGNING THIS DOCUMENT YOU ARE ACCEPTING THE CONDITIONS SET WITHIN. YOUR REQUIREMENTS MUST BE LISTED WITHIN THIS DRAWING. WHERE NO DIRECTION FROM THE CUSTOMER IS IDENTIFIED SAMTEC'S PROCESS REQUIREMENTS WILL BE USED.



DATE: _____
 COMPANY: _____
 CUSTOMER SIGNATURE: _____
 PRINTED NAME: _____
 PHONE NO: _____
 EXCEPTIONS: _____

UNLESS OTHERWISE SPECIFIED, DIMENSIONS ARE IN MILLIMETERS. TOLERANCES ARE: DECIMALS .XX: ±.10 .XXX: ±.05 ANGLES 5°	PROPRIETARY NOTE THIS DOCUMENT CONTAINS CONFIDENTIAL AND PROPRIETARY INFORMATION AND ALL DESIGN, MANUFACTURING, REPRODUCTION, USE, PATENT RIGHTS AND SALES RIGHTS ARE EXPRESSLY RESERVED BY SAMTEC, INC. THIS DOCUMENT SHALL NOT BE DISCLOSED, IN WHOLE OR PART, TO ANY UNAUTHORIZED PERSON OR ENTITY NOR REPRODUCED, TRANSFERRED OR INCORPORATED IN ANY OTHER PROJECT IN ANY MANNER WITHOUT THE EXPRESS WRITTEN CONSENT OF SAMTEC, INC.	 520 PARK EAST BLVD, NEW ALBANY, IN 47150 PHONE: 812-944-6733 FAX: 812-948-5047 e-Mail info@SAMTEC.com code 55322
MATERIAL: SHELL & CENTER CONTACT: PHOS BRONZE C5191 HOUSING: LCP, UL 94 V-0		
F:\DWG\MISC\MKTG\RSP-122811-01-MKT.SLDDRW		

ITEM NO.	PART NUMBER
1	RSP-122811-01

Looking for pricing, stock, or lifecycle information?

Click below to explore more details on WIN SOURCE:

-  [View RSP-122811-01 on WIN SOURCE](#)
-  [Samtec Inc. Information](#)

Optimize Your Supply Chain with WIN SOURCE Solutions

-  Global Sourcing Solution
-  Obsolete Management
-  Cost Control Management
-  Shortage Management
-  Alternative Solution
-  Excess Inventory Management